



L2 SWITCH

SWR2311P-10G

Owner's Manual
Bedienungsanleitung
Mode d'emploi
Manual de instrucciones
Manuale di istruzioni
Руководство пользователя

English

Deutsch

Français

Español

Italiano

Русский

EN
DE
FR
ES
IT
RU

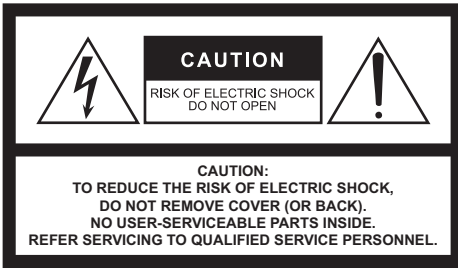

The above warning is located on the top of the unit.



L'avertissement ci-dessus est situé sur le dessus de l'unité.

Explanation of Graphical Symbols Explication des symboles



The lightning flash with arrowhead symbol within an equilateral triangle is intended to alert the user to the presence of uninsulated "dangerous voltage" within the product's enclosure that may be of sufficient magnitude to constitute a risk of electric shock to persons. L'éclair avec une flèche à l'intérieur d'un triangle équilatéral est destiné à attirer l'attention de l'utilisateur sur la présence d'une « tension dangereuse » non isolée à l'intérieur de l'appareil, pouvant être suffisamment élevée pour constituer un risque d'électrocution.



The exclamation point within an equilateral triangle is intended to alert the user to the presence of important operating and maintenance (servicing) instructions in the literature accompanying the product. Le point d'exclamation à l'intérieur d'un triangle équilatéral est destiné à attirer l'attention de l'utilisateur sur la présence d'instructions importantes sur l'emploi ou la maintenance (réparation) de l'appareil dans la documentation fournie.

IMPORTANT SAFETY INSTRUCTIONS

- 1 Read these instructions.
- 2 Keep these instructions.
- 3 Heed all warnings.
- 4 Follow all instructions.
- 5 Do not use this apparatus near water.
- 6 Clean only with dry cloth.
- 7 Do not block any ventilation openings. Install in accordance with the manufacturer's instructions.
- 8 Do not install near any heat sources such as radiators, heat registers, stoves, or other apparatus (including amplifiers) that produce heat.
- 9 Do not defeat the safety purpose of the polarized or grounding-type plug. A polarized plug has two blades with one wider than the other. A grounding type plug has two blades and a third grounding prong. The wide blade or the third prong are provided for your safety. If the provided plug does not fit into your outlet, consult an electrician for replacement of the obsolete outlet.
- 10 Protect the power cord from being walked on or pinched particularly at plugs, convenience receptacles, and the point where they exit from the apparatus.
- 11 Only use attachments/accessories specified by the manufacturer.
- 12 Use only with the cart, stand, tripod, bracket, or table specified by the manufacturer, or sold with the apparatus. When a cart is used, use caution when moving the cart/apparatus combination to avoid injury from tip-over.
- 13 Unplug this apparatus during lightning storms or when unused for long periods of time.
- 14 Refer all servicing to qualified service personnel. Servicing is required when the apparatus has been damaged in any way, such as power-supply cord or plug is damaged, liquid has been spilled or objects have fallen into the apparatus, the apparatus has been exposed to rain or moisture, does not operate normally, or has been dropped.



WARNING
TO REDUCE THE RISK OF FIRE OR ELECTRIC SHOCK, DO NOT EXPOSE THIS APPARATUS TO RAIN OR MOISTURE.

PRÉCAUTIONS CONCERNANT LA SÉCURITÉ

- 1 Lire ces instructions.
- 2 Conserver ces instructions.
- 3 Tenir compte de tous les avertissements.
- 4 Suivre toutes les instructions.
- 5 Ne pas utiliser ce produit à proximité d'eau.
- 6 Nettoyer uniquement avec un chiffon propre et sec.
- 7 Ne pas bloquer les orifices de ventilation. Installer l'appareil conformément aux instructions du fabricant.
- 8 Ne pas installer l'appareil à proximité d'une source de chaleur comme un radiateur, une bouche de chaleur, un poêle ou tout autre appareil (y compris un amplificateur) produisant de la chaleur.
- 9 Ne pas modifier le système de sécurité de la fiche polarisée ou de la fiche de terre. Une fiche polarisée dispose de deux broches dont une est plus large que l'autre. Une fiche de terre dispose de deux broches et d'une troisième pour le raccordement à la terre. Cette broche plus large ou cette troisième broche est destinée à assurer la sécurité de l'utilisateur. Si la fiche équipant l'appareil n'est pas compatible avec les prises de courant disponibles, faire remplacer les prises par un électricien.
- 10 Acheminer les cordons d'alimentation de sorte qu'ils ne soient pas pînés/nis coincés, en faisant tout spécialement attention aux fiches, prises de courant et au point de sortie de l'appareil.
- 11 Utiliser exclusivement les fixations et accessoires spécifiés par le fabricant.
- 12 Utiliser exclusivement le chariot, le stand, le trépied, le support ou la table recommandés par le fabricant ou vendus avec cet appareil. Si l'appareil est posé sur un chariot, déplacer le chariot avec précaution pour éviter tout risque de chute et de blessure.
- 13 Débrancher l'appareil en cas d'orage ou lorsqu'il doit rester hors service pendant une période prolongée.
- 14 Confier toute réparation à un personnel qualifié. Faire réparer l'appareil s'il a subi tout dommage, par exemple si la fiche ou le cordon d'alimentation est endommagé, si du liquide a coulé ou des objets sont tombés à l'intérieur de l'appareil, si l'appareil a été exposé à la pluie ou à de l'humidité, si l'appareil ne fonctionne pas normalement ou est tombé.



AVERTISSEMENT
POUR RÉDUIRE LES RISQUES D'INCENDIE OU DE DÉCHARGE ÉLECTRIQUE, N'EXPOSEZ PAS CET APPAREIL À LA PLUIE OU À L'HUMIDITÉ.

FCC INFORMATION (U.S.A.)

1. IMPORTANT NOTICE:

DO NOT MODIFY THIS UNIT!

This product, when installed as indicated in the instructions contained in this manual, meets FCC requirements. Modifications not expressly approved by Yamaha may void your authority, granted by the FCC, to use the product.

2. **IMPORTANT:** When connecting this product to accessories and/or another product use only high quality shielded cables. Cable/s supplied with this product **MUST** be used. Follow all installation instructions. Failure to follow instructions could void your FCC authorization to use this product in the USA.

3. **NOTE:** This product has been tested and found to comply with the requirements listed in FCC Regulations, Part 15 for Class "A" digital devices. Compliance with these requirements provides a reasonable level of assurance that your use of this product, in a commercial environment, will not result in harmful interference with other electronic devices. However, operation of this product in a residential area is likely to cause interference in some form. In this case you, the user, bear the responsibility of correcting this condition.

This product generates/uses radio frequencies and, if not installed and used according to the instructions found in the

users manual, may cause interference harmful to the operation of other electronic devices. Compliance with FCC regulations does not guarantee that interference will not occur in all installations. If this product is found to be the source of interference, which can be determined by turning the product "OFF" and "ON", please try to eliminate the problem by using one of the following measures:

Relocate either the product generating the interference or the device that is being affected by the interference.

Utilize power outlets that are on different branch (circuit breaker or fuse) circuits or install AC line filter/s.

In the case of radio or TV interference, relocate/reorient the antenna. If the antenna lead-in is 300 ohm ribbon lead, change the lead-in to co-axial type cable.

If these corrective measures do not produce satisfactory results, please contact the local retailer that is authorized to distribute this type of product. If you can not locate the appropriate retailer, please contact Yamaha Corporation of America, Electronic Service Division, 6600

Orangethorpe Ave, Buena Park, CA90620

The above statements apply **ONLY** to those products distributed by Yamaha Corporation of America or its subsidiaries.

(class A)

PRECAUTIONS

PLEASE READ CAREFULLY BEFORE PROCEEDING

Please keep this manual in a safe place for future reference.



WARNING

Always follow the basic precautions listed below to avoid the possibility of serious injury or even death from electrical shock, short-circuiting, damages, fire or other hazards. These precautions include, but are not limited to, the following:

If you notice any abnormality

- If any of the following problems occur, immediately disconnect the electric plug from the outlet.
 - The power cord or plug becomes frayed or damaged.
 - Unusual smells or smoke are emitted.
 - Some object, or water has been dropped into the product.
 - There is a sudden loss of sound during use of the product.
 - Cracks or other visible damage appear on the product.

Then have the product inspected or repaired by qualified Yamaha service personnel.

Power supply/power cord

- Do not place the power cord near heat sources such as heaters or radiators, and do not excessively bend or otherwise damage the cord, place heavy objects on it, or place it in a position where anyone could walk on, trip over, or roll anything over it.

- Only use the voltage specified as correct for the product. The required voltage is printed on the name plate of the product.
- Use only the supplied power cord/plug. If you intend to use the product in an area other than in the one you purchased, the included power cord may not be compatible. Please check with your Yamaha dealer.
- Check the electric plug periodically and remove any dirt or dust which may have accumulated on it.
- Make sure to fully insert the electric plug to prevent electric shocks or fire.
- When setting up the product, make sure that the AC outlet you are using is easily accessible. If some trouble or malfunction occurs, immediately disconnect the plug from the outlet. As long as the power cord is not unplugged from the wall AC outlet, the product will not be disconnected from the power source.
- Remove the electric plug from the outlet when the product is not to be used for extended periods of time.
- Do not touch the product or the electric plug during an electrical storm.
- Be sure to connect to an appropriate outlet with a protective grounding connection. Improper grounding can result in electrical shock, fire, or damage.
- If you plan to connect a powered device that complies with the IEEE802.3 standards, use a CAT5e or higher-grade cable. Failure to observe this precaution could result in a fire or malfunction.

Do not open

- This product contains no user-serviceable parts. Do not attempt to disassemble the internal parts or modify them in any way.

Water warning

- Do not expose the product to rain, use it near water or in damp or wet conditions, or place on it any containers (such as vases, bottles or glasses) containing liquids which might spill into any openings.
- Never insert or remove an electric plug with wet hands.
- Do not place any burning items or open flames near the product, since they may cause a fire.

Hearing loss

- When turning on the AC power in your audio system, always turn on the power amplifier LAST, to avoid hearing loss and speaker damage. When turning the power off, the power amplifier should be turned off FIRST for the same reason.



CAUTION

Always follow the basic precautions listed below to avoid the possibility of physical injury to you or others, or damage to the product or other property. These precautions include, but are not limited to, the following:

Power supply/power cord

- When removing the electric plug from the product or an outlet, always hold the plug itself and not the cord. Pulling by the cord can damage it.

Location and connection

- Do not place the product in an unstable position where it might accidentally fall over and cause injuries.
- Keep the device and small parts out of reach of children, to keep them from putting their fingers into openings on the product and accidentally being injured. There is a danger that children might swallow small parts. This product is not suitable for use in locations where children are likely to be present.
- Do not block the vents. This product has ventilation holes at the top/front/rear/sides to prevent the internal temperature from becoming too high. In particular, do not place the product on its side or upside down. Inadequate ventilation can result in overheating, possibly causing damage to the product(s), or even fire.

- When installing the product:
 - Do not cover it with any cloth.
 - Do not install it on a carpet or rug.
 - Make sure the top or side surface faces up; do not install on its front, rear, or upside down.
 - Do not use the product in a confined, poorly-ventilated location.

Inadequate ventilation can result in overheating, possibly causing damage to the product(s), or even fire. If this product is to be used in a small space other than an EIA-standard rack, make sure that there is adequate space around the product: at least 2.5 cm above, and 10 cm behind.

- Do not use the separately sold WK-SWR wall mount accessory to attach the unit to a ceiling that is higher than 2 meters. If the unit falls, injury or damage might occur.
- If the product is mounted in an EIA standard rack, carefully read the section "Please read before mounting the unit into a rack" on page 20. Inadequate ventilation can result in overheating, possibly causing damage to the product(s), malfunction, or even fire.

- Do not place the product in a location where it may come into contact with corrosive gases or salt air. Doing so may result in malfunction.
- Before moving the product, remove all connected cables.
- Always consult qualified Yamaha service personnel if the product installation requires construction work, and make sure to observe the following precautions.
 - Choose mounting hardware and an installation location that can support the weight of the product.
 - Avoid locations that are exposed to constant vibration.
 - Use the required tools to install the product.
 - Inspect the product periodically.

Maintenance

- Remove the power plug from the AC outlet when cleaning the product.

Handling caution

- Do not insert your fingers or hands in any gaps or openings on the product (vents, ports, panel, etc.).
- Do not rest your weight on the product or place heavy objects on it.
- Do not look into the optical emitter when a separately sold SFP module (SFP-SWRG-LX, SFP-SWRG-SX) is installed.
The separately sold SFP modules are class 1 laser devices. They may emit laser beams invisible to the eye. If the laser beam enters your eye, your eyesight might be damaged.

Backup battery

- Do not replace the backup battery by yourself. Doing so may cause an explosion and/or damage to the product(s).
When the backup battery needs to be replaced, contact your Yamaha dealer and have qualified Yamaha service personnel replace the backup battery.

Yamaha cannot be held responsible for damage caused by improper use or modifications to the product, or data that is lost or destroyed.

NOTICE

To avoid the possibility of malfunction/ damage to the product, damage to data, or damage to other property, follow the notices below.

Handling and maintenance

- Do not touch any port with your fingers or anything metallic. Failure to observe this precaution could result in damage to the product.
- Do not expose the product to excessive dust or vibration, or extreme cold or heat (such as in direct sunlight, near a heater, or in a car during the day), in order to prevent the possibility of panel disfiguration, unstable operation, or damage to the internal components.
- Condensation can occur in the product due to rapid, drastic changes in ambient temperature—when the product is moved from one location to another, or air conditioning is turned on or off, for example. Using the product while condensation is present can cause damage. If there is reason to believe that condensation might have occurred, leave the product for several hours without turning on the power until the condensation has completely dried out.
- Do not place vinyl, plastic or rubber objects on the product, since this might discolor the panel.
- When cleaning the product, use a dry and soft cloth. Do not use paint thinners, solvents, cleaning fluids, or chemical-impregnated wiping cloths.
- Be sure to earth (ground) any static electricity from your body or clothing before touching the product. Failure to observe this precaution could result in damage to the product.
- Do not install the product in a location where magnetic fields are strong. Otherwise, it might cause the product to malfunction.
- Do not connect any noise generating devices on the same power line as the product. Failure to observe this precaution could result in a malfunction or damage to the product.
- Do not locate any connected LAN cables close to the power cord. Otherwise, high voltage might be induced, resulting in malfunction.
- A 1000BASE-T connection will require an Enhanced Category 5 (CAT5e) or better LAN cable.
- Do not install any SFP module other than the separately sold SFP-SWRG-LX or SFP-SWRG-SX in an SFP port. Operation cannot be guaranteed if any SFP module other than the above is installed.
- Attach the dust cover to SFP ports that are not in use. Failing to do so could allow foreign objects to enter, causing malfunctions. Keep the dust cover in a safe place so that it is not lost.
- The rubber feet included in this package can be attached to the product to prevent slippage when it is to be used on a slippery surface.

Saving data

- This unit has a built-in backup battery that maintains time information for the data. When the backup battery runs down, the time information will be initialized, causing incorrect time information to be recorded in the log. If this occurs, contact your dealer or a Yamaha customer service center to have the backup battery replaced. The life span of the backup battery is approximately 10 years, but this may vary depending on the conditions of use. Set the clock after replacing the battery.
 - Data maintained by the backup battery:
 - Time information.

About functions/data bundled with the product

- This is a class A product. Operation of this product in a residential environment could cause radio interference.

About this manual

- The illustrations as shown in this manual are for instructional purposes only.
- Windows is a registered trademark of Microsoft® Corporation in the United States and other countries.
- The company names and product names in this manual are the trademarks or registered trademarks of their respective companies.
- Software may be revised and updated without prior notice.

About disposal

- This product contains recyclable components. When disposing of this product, please contact the appropriate local authorities.

Open Source Software Used in this Product

- Please refer to Yamaha Pro Audio website for the details of licensing article. <http://www.yamaha.com/proaudio/>

The model number, serial number, power requirements, etc., may be found on or near the name plate, which is at the top of the unit. You should note this serial number in the space provided below and retain this manual as a permanent record of your purchase to aid identification in the event of theft.

Model No.

Serial No.



廢電池請回收

(top_en_01)

- Suitable for installation in Information Technology Rooms in accordance with Article 645 of the National Electrical Code and NFPA 75.
- The device can only be used in a fixed location such as a telecommunication centre, a dedicated computer room. When you install the device, ensure that the protective earthing connection of the socket-outlet is verified by a skilled person.

Particular usage in this manual

The following company and product names will be abbreviated as below in this manual.

- Yamaha L2 Switch SWR2311P-10G: This product
- 10BASE-T/100BASE-TX/1000BASE-T cable: LAN cable

COTENTS

PRECAUTIONS	4
NOTICE	7
Introduction	10
Features	10
Separately sold items	10
Related software and documents	10
Controls and Connectors	11
Front Panel	11
Top panel	13
Rear panel	14
Side panel.....	14
Bottom panel.....	15
Switching the display mode	16
Port indicators	17
Installation in a rack	20
Installation on a wall or ceiling	22
Settings	25
Making settings using the Web GUI.....	25
Making settings from the command line using the CONSOLE port.....	26
Connections	28
Initialization	31
Appendix	33
Hardware specifications.....	33
Dimensional diagram	34
RJ-45/DB-9 console cable pin configuration.....	35
Software license agreement	35
Index	38

Accessories

Please ensure that you have all of the following accessories.

- Owner's Manual (this manual)
- Power Cord
- Power Cord Clamp (used only for the included dedicated power cord)
- Leg (Rubber feet) (x4)

Introduction

Thank you for purchasing the Yamaha SWR2311P-10G intelligent L2 switch.

This product supplies power to PoE powered devices on the network.

This owner's manual is intended for installers and facility designers, and explains installation methods and settings.

Please be sure to read this manual before you start using the product to take full advantage of its features.

Please retain this manual in a safe location for future reference.

Features

- Recommended settings for stable operation of a Dante network (such as QoS, EEE, and IGMP Snooping) can be made easily.
- Up to 30W of power can be simultaneously supplied to each port that supports PoE power supply.
- A function is provided to automatically reset a device that is being powered from this unit by turning its power supply on/off if an abnormality is detected in that device.
- The PoE supply status can be checked or turned on/off via Yamaha LAN Monitor.

Separately sold items

- RK-SWR rack mount accessory: This is required when installing the unit in a 19-inch rack.
- WK-SWR wall mount accessory: This is required when installing the unit on a wall or on a ceiling less than 2 meters high.
- SFP-SWRG-LX or SFP-SWRG-SX SFP module: This is required when connecting via 1000BASE-LX or 1000BASE-SX.

Related software and documents

- **Yamaha LAN Monitor/Yamaha LAN Monitor User Guide**

This is a Windows application used to monitor this unit's information and the entire network including all Dante devices on the Dante network, and the user guide for this application.

- **Yamaha Network USB Serial Driver/Yamaha Network USB Serial Driver Installation Guide**

This is a Windows driver that allows communication when the mini-USB CONSOLE port is connected via a USB cable to a computer, and the installation guide for this driver.

- **Command Reference**

This explains the commands used when using the command line to make settings from a computer.

- **Technical Reference**

This describes details of the SWR2311P-10G's functions.

This software and these documents can be downloaded from the following website.

<http://www.yamaha.com/proaudio/>

Controls and Connectors

Front Panel

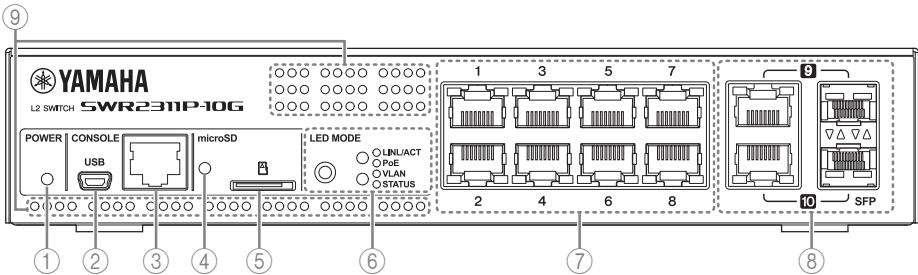

① POWER indicator

Lights when power is provided to the unit.

POWER indicator	Status
Unlit	Power off
Flashing (green)	Power on, starting up
Lit (green)	Power on, normal
Lit (orange)	Power on, error occurred



Caution

When one of the following problems occurs, the POWER indicator is lit orange. Verify the status of the problem, and take the appropriate action. Refer to the Web GUI to determine which specific problem has occurred.

- Fan stopped
The fan that exhausts the heat dissipated by this unit has stopped.
You must immediately stop using the unit, and contact a Yamaha service center listed at the end of this manual to have the unit repaired or inspected.
- Abnormal temperature inside this unit.
The temperature inside this unit is abnormal.
Reconsider the environment in which this unit is installed, and correctly install this unit so that its internal temperature is appropriate.

② mini-USB CONSOLE port

This is a mini-USB port for making settings. Use a USB cable to connect it to the USB port of a computer. Use a USB cable equipped with a USB Type A connector and a mini-USB Type B (5-pin) connector.

Notice

Use a cable that supports data transfer. Charge-only cables cannot be used.

Controls and Connectors

③ RJ-45 CONSOLE port

This is an RJ-45 port for making settings. Use an RJ-45/DB-9 console cable to connect it to the RS-232C connector (COM port) of the computer. Use an RJ-45/DB-9 serial cable that is wired as described in “Appendix.”

④ microSD indicator

Indicates the connected and operating status of the microSD card.

microSD indicator	Status
Unlit	No microSD card is inserted in the slot.
Flashing (green)	The microSD card is being accessed.
Lit (green)	A microSD card is inserted in the slot.



Caution

Do not remove the microSD card if this indicator is flashing green.

Doing so will damage the data.

⑤ microSD slot

A microSD card can be inserted in this slot.

⑥ MODE button and MODE indicator

When you press the MODE button, the display mode of the port indicators is switched in the following sequence, allowing you to check the current status by the upper and lower MODE indicators.

- When the initial display mode is LINK/ACT
[LINK/ACT] ► [PoE] ► [VLAN] ► [STATUS] ► [OFF] ► back to [LINK/ACT].
- For details on the MODE button that switches modes and the MOD indicator, refer to “Switching the display mode” (page 16).
- For details on the port indicators in each selected mode, refer to “Port indicators” (page 17).

⑦ LAN ports

These ports can supply PoE and are compatible with 10BASE-T, 100BASE-TX, and 1000BASE-T.

PoE supply is compliant with IEEE 802.3at, and can supply up to 30W to all ports.

⑧ LAN/SFP combo ports

These can be used either as LAN ports or SFP ports.

LAN ports are 1000BASE-T uplink ports. They do not have power supply capability. SFP ports are for installing a separately sold SFP module (SFP-SWRG-LX or SFP-SWRG-SX).

For details on installing an SFP module, refer to “Installing an SFP module” (page 28) in “Connections.”



Caution

Do not connect a cable to both the LAN port and the SFP port of the same port number.

Doing so might cause a malfunction.

⑨ Cooling vents

External air is taken in through these cooling vents.



Warning

Do not block the cooling vents or place objects near them.

Doing so could cause fire or malfunctions.

Top panel

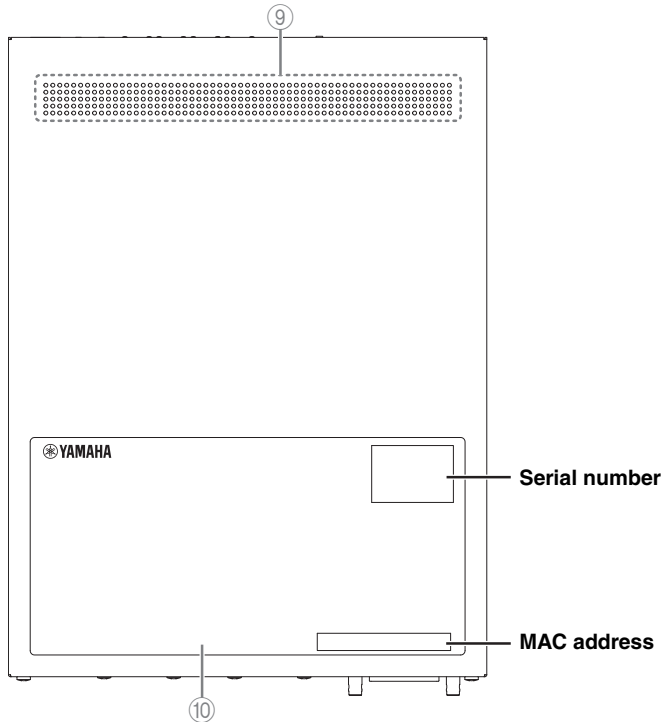

⑩ Product label

This lists the model name, serial number, and MAC address etc. of this unit.

Rear panel

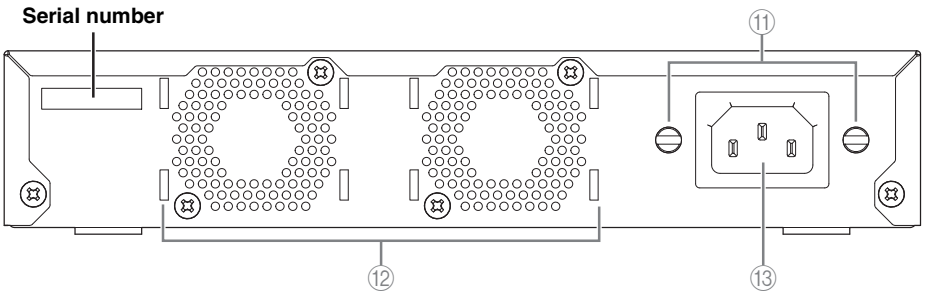

11 Power cord clamp attachment holes

The included power cord clamp (C-shaped) can be attached here. Refer to “Connecting the power cord” (page 30) for information on how to install the unit.

12 Fans

These forcibly exhaust the heat that is generated inside the unit. When a problem is detected, the POWER indicator is lit orange.



Caution

Do not block the fan vents or place objects near them. Doing so could cause fire or malfunctions.

13 Power supply inlet (three-pin connector, C14 type)

Insert the included power supply cord here. Connect it to an electrical outlet of the appropriate voltage for the unit.

Side panel

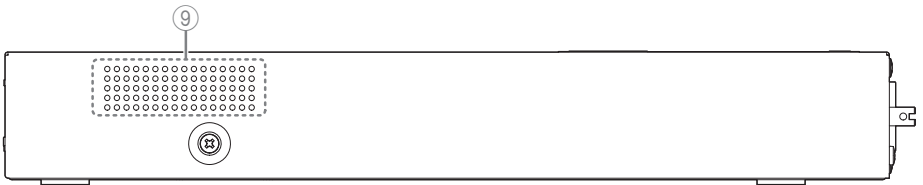

Bottom panel

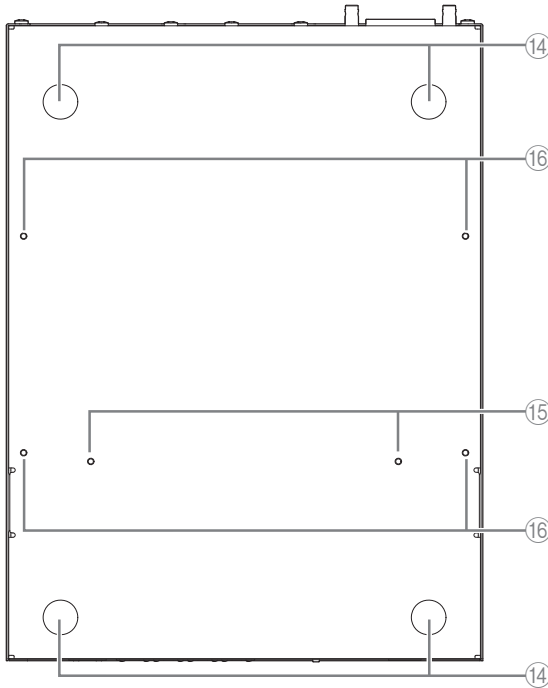

14 Leg attachment guides

These indicate the locations at which the legs are to be attached when the unit is installed in a horizontal position.

If the unit is to be installed in a horizontal position, attach the included legs as shown in the illustration.

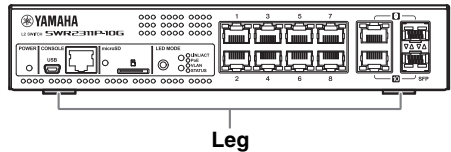
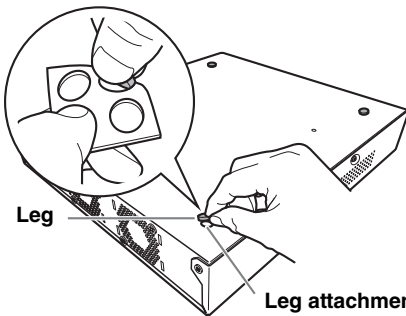

15 Rack mount accessory attachment holes

Use these holes to attach the RK-SWR rack mount accessory.

Refer to “Installation in a rack” (page 20) for information on how to install the unit.

Controls and Connectors



16 Wall mount accessory attachment holes

Use these holes to attach the WK-SWR wall mount accessory.

Refer to “Installation on a wall or ceiling” (page 22) for information on how to install the unit.

Switching the display mode

Each time you press the MODE button, the display mode of the port indicators is switched. The lit status and color of the upper and lower MODE indicators shows the selected display mode.

Unlit:  Lit (green):  Lit (orange): 

(when the initial display mode is LINK/ACT)

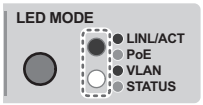
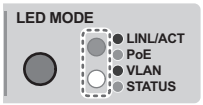
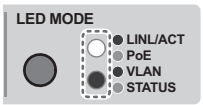
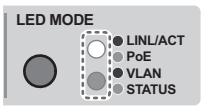
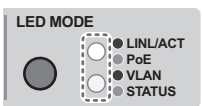
Mode name	Lit state of the mode indicators	Explanation
1 LINK/ACT	 <p>Upper Lit (green) Lower Unlit</p>	The left indicator of the LAN port or SFP port shows the link status, and the right indicator shows the connection speed.
2 PoE	 <p>Upper Lit (orange) Lower Unlit</p>	Indicates the power supply status of the LAN port.
3 VLAN	 <p>Upper Unlit Lower Lit (green)</p>	Indicates the VLAN ID specified for the LAN port or SFP port.
4 STATUS	 <p>Upper Unlit Lower Lit (orange)</p>	Indicates the error status of the LAN port or SFP port.
5 OFF	 <p>Upper Unlit Lower Unlit</p>	Turns off the indicators of the LAN ports and SFP ports.

1 Back to LINK/ACT

Port indicators

These are indicators for the LAN ports and SFP ports, and indicate the state of each port in each mode.

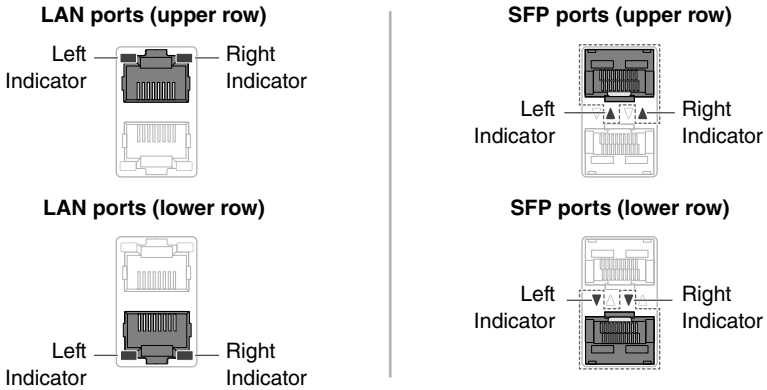

■ LINK/ACT mode

The indicators show the link status and connection speed of the LAN port or SFP port.

LAN ports

Left indicator	Link status	Right indicator	Connection speed
Unlit	The link is lost. (unavailable)	Unlit	Not connected. Alternatively, connected by 10BASE-T.
Lit (green)	A link is established. (available)	Lit (orange)	Connected by 100BASE-TX.
Flashing (green)	Data is flowing.	Lit (green)	Connected by 1000BASE-T.

SFP ports

Left indicator	Link status	Right indicator	Connection speed
Unlit	The link is lost. (unavailable)	Unlit	Not connected.
Lit (green)	A link is established. (available)	Lit (green)	Connected by 1000BASE-LX or 1000BASE-SX.
Flashing (green)	Data is flowing.		

Controls and Connectors

■ PoE mode

Indicates the power supply status.

Left indicator	Power supply status
Unlit	Not supplying power.
Lit (green)	Supplying power.

The right indicator is unlit.

■ VLAN mode

Indicates the VLAN membership status of the LAN port or SFP port.

Left indicator	Right indicator	VLAN ID	Indicator assignment order
Unlit	Unlit	No ID	–
Lit (green)	Unlit	Lowest-numbered VLAN ID	1
Lit (orange)	Unlit	The lit pattern is assigned in ascending order of the VLAN ID number.	2
Unlit	Lit (green)		3
Unlit	Lit (orange)		4
Lit (green)	Lit (orange)		5
Lit (orange)	Lit (green)		6
Lit (green)*1	Lit (green)*1	7th and subsequent VLAN ID	7
Lit (orange)	Lit (orange)	Membership in more than one VLAN	–

*1 Indicators whose VLAN ID is number 7 or later will have the same lit status.

NOTE

The default VLAN (ID=1) is not shown as a member VLAN.

■ STATUS mode

Indicates the error status of the LAN port or SFP port.

When the following errors are detected, the unit forcibly enters STATUS mode.

- Loop detected
- SFP optical input level abnormality detected
- PoE supply stoppage or receiving device error detected

LAN ports

Left indicator	Right indicator	Error information
Unlit	Unlit	Normal
Flashing (orange)	Unlit	A loop was detected. The port has been blocked or shut down.
Lit (orange)	Unlit	A fault has occurred in the device receiving power, and power is not being supplied.
Unlit	Flashing (orange)	Because the maximum total electrical power that this unit can supply has been exceeded, power supply to this port was stopped. Since the total supplied electrical power has exceeded the safety margin, it is not possible to add more devices that receive electrical power. *1
Unlit	Lit (orange)	Power supply is suspended because the power output at the port has exceeded the maximum power supply allowed per port. The maximum power supply allowed per port varies depending on the power consumption class of the connected powered device.

*1 This unit can supply a total of 240W. For details on the safety margin, refer to the technical documentation of the SWR2311P-10G.

SFP ports

Left indicator	Status
Unlit	Normal
Flashing (orange)	A loop or an SFP optical input level abnormality was detected.

The right indicator is unlit.

For details, refer to the page for this unit on the Yamaha Pro Audio website.

<http://www.yamaha.com/proaudio/>

NOTE

- The error causes can be determined by using the show error port-led command.
- You can forcibly reset the error status by long-pressing (three seconds) the MODE button.
- When all errors are cleared, or when the error status is forcibly reset by long-pressing the MODE button, the unit automatically returns to the initial display mode.

■ OFF mode

Turns off the indicators of the LAN ports and SFP ports.

Installation in a rack

This section explains how to attach an optional RK-SWR rack mount accessory to the unit.

Please read before mounting the unit into a rack

This unit is warranted to operate in an ambient temperature range of 0–40 °C. If you install this unit along with other devices into an EIA-standard or JIS-standard rack, the temperature inside the rack may rise due to heat released from the other devices, resulting in poor performance of the unit. To prevent the temperature inside the unit from rising, mount the unit in the rack in accordance with the requirements below.

- If you plan to rack-mount the unit along with a device that tends to generate heat, such as an amplifier (excluding an XMV series), be sure to leave a gap of 1U or more from such devices. Also, be sure to maintain sufficient ventilation in this space by installing a ventilation panel or leaving it open.
- Open the rear panel of the rack, place the rack 10cm (about four inches) away from the walls and ceiling to keep sufficient ventilation. If you cannot open the rear panel of the rack, install a commercially-available forced ventilation device, such as a fan kit. If you install a fan kit, closing the rear panel may work better for heat dissipation purposes. For more information, refer to the owner's manual for the rack and/or fan kit.



Caution

If you plan to relocate the rack, be sure to first remove this unit from the rack.

If you move the unit while it is still installed in the rack, vibration or physical shock might deform or damage the rack mount accessory, causing injury. This might also cause the unit to malfunction.

[Installation]

This section explains how to attach the unit in the middle block of a rack mount panel. If you plan to attach the unit in the left or right block, follow the same procedure below.

Notice

If the supplied feet have already been attached to the unit, remove them.

1. Attaching the rack mount panel to the unit

Use two screws (supplied with the rack-mount accessory) to attach and secure the rack mount panel to the bottom panel of the unit.



Warning

Use only the specified screws that were included.

Failure to do so might allow the unit to fall, causing injury or damage. This could also cause electric shock or malfunctions.

Rack mount panel Screws

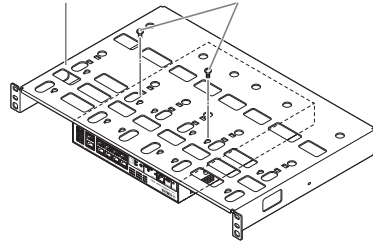

2. Installing the rack mount panel to the 19-inch rack

Using the four screws included with the 19-inch rack, attach the rack mount panel. Be sure to tighten the screws so that they will not get loosened.

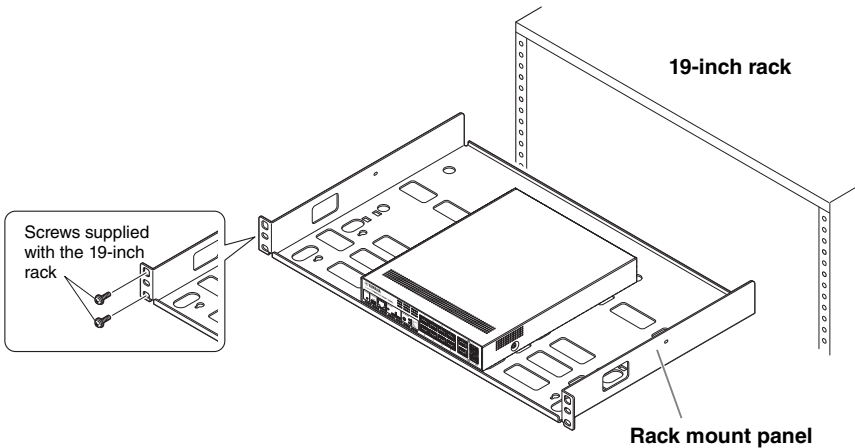

You can also mount two units as shown in the figure below.

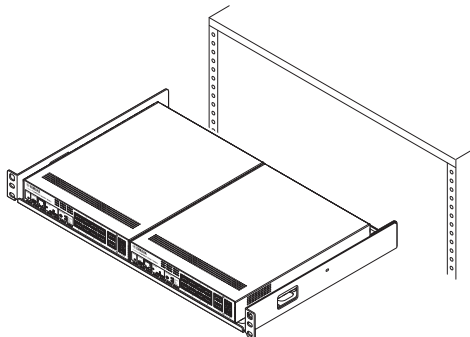

Installation on a wall or ceiling

Use the separately sold WK-SWR wall mount accessory to install the unit.

If attaching this unit to a ceiling, invert the top and bottom of the unit.

You will need to obtain six screws that fit the holes described in step 1 and are appropriate for the material and thickness of the wall or ceiling.

Carry out the installation completely, all the way to step 7.



Warning

Do not attach this unit to a ceiling that is higher than 2 meters.

If the unit falls, injury or damage might occur.



Caution

- **When attaching or removing this unit, you must disconnect the unit's power plug from the power outlet.**

Failing to do so could cause electrical shock or malfunctions.

- **Installation must be performed by a qualified installer.**

During installation, pay attention to the following points.

- Choose hardware and a location that is well able to support the weight of this unit
- Avoid locations that are subject to sustained vibration
- You must use the specified installation accessory
- Perform periodic maintenance checks

Notice

The mounting accessory has a surface to which the SWR2311P-10G must be attached and a surface that must be attached to the wall.

If these two surfaces are confused, it will not be possible to attach the mounting accessory to the SWR2311P-10G. To distinguish the surfaces, refer to the illustrations for step 1 and step 3.

1. Place the mounting accessory against the wall, and mark the installation location.

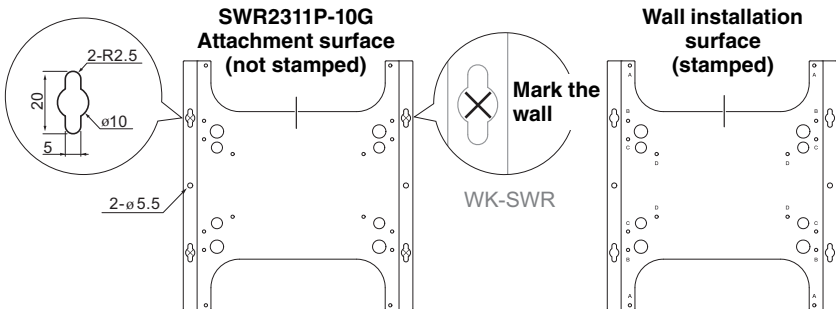

Wall installation methods (two types)

The SWR2311P-10G can be installed on a wall in the following two ways.



Warning

Do not install with the LAN ports facing upward or downward.

Doing so could cause fire or malfunctions.

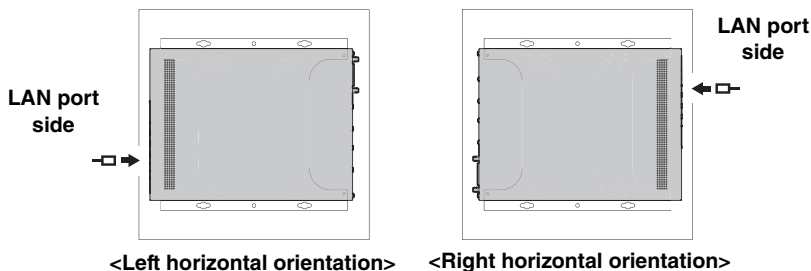

2. Provisionally attach four commercially available screws to the locations that you marked in step 1.

At this time, leave approximately 2 mm between the head of the screw and the surface of the wall, allowing room for the mounting accessory to engage the screws. (illustration at right)

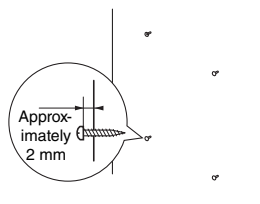

Warning

You must use screws that are appropriate for the material of the wall.

If the unit falls, injury or damage might occur.

3. Align the unit with the mounting accessory (illustration at right).

Notice

If the supplied feet have already been attached to the unit, remove them.

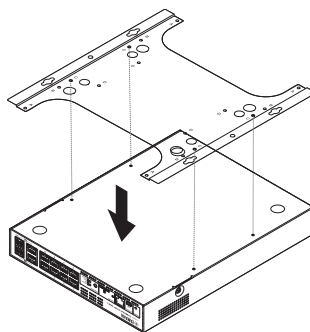

Installation on a wall or ceiling

4. Using four screws included with the mounting accessory, attach it to the SWR2311P-10G.

Fasten it securely.



Warning

- Use only the specified screws that were included.

If the unit falls, injury or damage might occur. This could also cause electric shock or malfunctions.

- Take care when letting your hand or finger contact the corners of the mounting accessory. Inattention might cause injury.

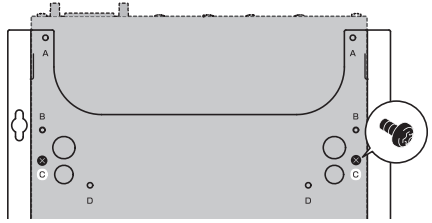

Notice

The screw holes to use are stamped with a "C" on the mounting accessory. The screws to use are the small black M3 × 4 screws for the metal chassis.

5. Engage the assembled mounting accessory onto the commercially available screws that you provisionally attached in step 2, and slide it to the side.



Warning

Do not drop the unit.

If the unit falls, injury or damage might occur.

Notice

When installing the SWR2311P-10G, engage the mounting accessory onto the screws that you provisionally attached in step 2, and slide it either to the left or the right.

[Installing in left horizontal orientation]

[Installing in right horizontal orientation]

Screw hole for fastening (step 7)

Screw hole for fastening (step 7)

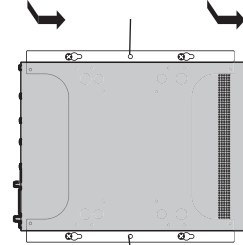
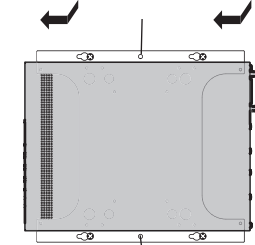

Screw hole for fastening (step 7)

Screw hole for fastening (step 7)

6. Further tighten the commercially available screws that you provisionally attached in step 2, fastening the mounting accessory.

7. Install two commercially available screws in the fastening screw holes (two locations) of the mounting accessory.



Warning

You must use screws that are appropriate for the material of the wall.

If the unit falls, injury or damage might occur.

Settings

Settings for this unit can be made in the following ways.

- Make settings using the Web GUI
- Make settings from the command line using the CONSOLE port
- Make settings from the command line using Telnet
- Make settings from the command line using SSH

This document explains “Making settings using the Web GUI” (page 25) and “Making settings from the command line using the CONSOLE port” (page 26).

You can log in to this unit either as a standard user or as an administrative user. This document explains how to log in as an administrative user.

For details on the commands used by this unit, refer to the Command Reference.

The Command Reference is available on the Yamaha Pro Audio website.

<http://www.yamaha.com/proaudio/>

Making settings using the Web GUI

Here we explain the procedure for logging in to this unit using the Web GUI.

You will use Yamaha LAN Monitor to log in to the Web GUI, so install Yamaha LAN Monitor before you continue.

Before you log in, connect your computer to the same network.

If the date and time are incorrect, set the date and time either in the Web GUI’s “Management” tab - “Device settings” page.

For details on supported web browsers, refer to the Yamaha Pro Audio website.

<http://www.yamaha.com/proaudio/>

■ Logging in to this unit using a web browser

1. Start Yamaha LAN Monitor.

2. Select the device for which you want to make settings, and click the “Web GUI” button in the “Device Details” view.

When access is successful, a dialog box appears where you can enter a user name and password.

3. If you are making settings ahead of time, enter the user name and password, and click the “Login” button.

With the factory settings, the user name and password are not specified, so it is not necessary to enter a user name and password.

Making settings from the command line using the CONSOLE port

Here we explain the cable, driver, software, and settings that are necessary in order to use the CONSOLE port.

If the date and time are incorrect, set the date and time either in “clock set” command / “clock timezone” command.

For details on the commands used by this unit, refer to the Command Reference.

The Command Reference is available on the Yamaha Pro Audio website.

<http://www.yamaha.com/proaudio/>

■ Preparing a console cable

- Connect the computer to the CONSOLE port of this unit using a USB cable or an RJ-45/DB-9 console cable.
- As the USB cable connected to the mini-USB CONSOLE port, use a USB cable that is equipped with a USB Type A connector and a mini-USB Type B (5-pin) connector, and that supports data communication. Charge-only cables cannot be used.

■ Installing the USB serial driver

- In order to use the mini-USB CONSOLE port, the USB serial driver must first be installed in the computer.
- For details on installing the USB serial driver, refer to the “Yamaha Network USB Serial Driver Installation Guide.”

The Yamaha Network USB Serial Driver Installation Guide and the installer can be downloaded from the Yamaha Pro Audio website.

<http://www.yamaha.com/proaudio/>

■ Preparing the computer

You will need terminal software that controls the serial (COM) port of the computer.

Set the parameters of the terminal software as follows.

Parameter	Value
Data transmission speed	9600 bps
Character bit length	8
Parity check	None
Number of stop bits	1
Flow control	Xon/Xoff

If the computer is connected to both the RJ-45 CONSOLE port and the mini-USB CONSOLE port, only the terminal software that uses the mini-USB CONSOLE port can make settings.

The messages that are output from this unit are output to both CONSOLE ports.

■ Logging in from a computer connected to the CONSOLE port

1. Using a console cable, connect this unit to the computer.

Connect the computer to the CONSOLE port of this unit using a USB cable or an RJ-45/DB-9 console cable.

Notice

- The LAN ports and the RJ-45 CONSOLE port all use the same 8-pin connector. If you connect these wrongly, hardware damage or malfunction might occur. Take care when making connections.
- If you use the mini-USB CONSOLE port, do not use a USB hub. If multiple Yamaha switches are connected to one computer, the COM port numbers assigned to the connection might be inadvertently exchanged. Take care that you are not changing the settings of an unintended unit.

2. Check the power supply of this unit.

If this unit is not powered-on, turn on the power as described in “Connecting the power cord” (page 30). When this unit powers-on and the command line is usable, a startup message appears in the console screen of the computer.

If the power is already on, a startup message does not appear.

```
SWR2311P-10G Rev.2.02.01 (Mon Sep 4 16:28:06 2018)
Copyright (c) 2018 Yamaha Corporation. All Rights
Reserved.
```

3. Press the <Enter> key.

The system waits for a user name to be entered.

If a user name has already been specified, enter the user name.

When the unit is shipped from the factory, a user name has not been specified, so it need not be entered.

```
Username:
```

4. Press the <Enter> key.

The system waits for a password to be entered.

If a password has already been specified, enter the password.

When the unit is shipped from the factory, a password has not been specified, so it need not be entered.

```
Password:
```

5. Press the <Enter> key.

If password authentication is successful, the command prompt appears, allowing you to enter commands.

```
SWR2311P>
```

For details on the commands, refer to the command reference.

Connections

■ Connecting network devices, PoE powered devices, or a computer

Using LAN cables, connect the LAN port of each device to the LAN ports of this unit.

If using fiber optic cables to make connections, install an SFP module in an SFP port. For the installation procedure, refer to “Installing an SFP module” (page 28).



Warning

If you plan to connect a powered device that complies with the IEEE802.3at standards, use a CAT5e or higher-grade cable.

Failure to use a standards-compliant cable for connection could result in a fire or malfunction.

Notice

The LAN ports and the RJ-45 CONSOLE port all use the same 8-pin connector.

If you connect these wrongly, hardware damage or malfunction might occur. Take care when making connections.

■ Installing an SFP module

The SFP ports accept installation of an SFP module (SFP-SWRG-LX, SFP-SWRG-SX).

NOTE

For details on installation, removal, and points of caution, refer to the “SFP-SWRG-LX SFP-SWRG-SX Owner’s Manual” included with the SFP module.

1. Remove the dust cover that is affixed to this unit’s SFP port, and insert the SFP module.

NOTE

Since this unit supports hot-swapping, an SFP module can be installed without turning the power off.

2. Remove the protective cap from the SFP module.



Caution

Do not look into the optical emitter when the SFP module is installed.

The separately sold SFP modules are class 1 laser devices. They may emit laser beams invisible to the eye. If the laser beam enters your eye, your eyesight might be damaged.

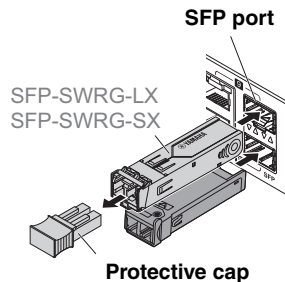

3. To the connector, connect a fiber optic cable that is suitable for each module.

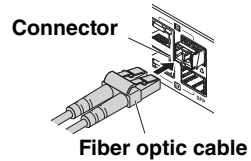

■ Removing an SFP module

Secure this unit so that it will not move, and while grasping the lever of the SFP module, pull it slowly toward yourself to remove the module from the SFP port.

NOTE

For details on installation, removal, and points of caution, refer to the “SFP-SWRG-LX SFP-SWRG-SX Owner’s Manual” included with the SFP module.

1. Detach the fiber optic cable.

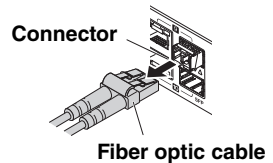

2. If the SFP module is connected to the upper row of ports, lower the SFP module’s lever.

If it is connected to the lower row of ports, raise the lever.



Caution

Do not look into the optical emitter when the SFP module is installed.

The separately sold SFP modules are class 1 laser devices. They may emit laser beams invisible to the eye. If the laser beam enters your eye, your eyesight might be damaged.

3. Grasp the lever and pull out the SFP module.

NOTE

Since this unit supports hot-swapping, an SFP module can be removed without turning the power off.

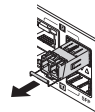

Connections

■ Connecting the power cord

1. Attach the included power cord clamp.

Notice

- We recommend that you attach the supplied power cord clamp to prevent the power cord from accidentally being disconnected.
- This clamp is used only for the supplied power cord. If you use the clamp for other power cords, they might be damaged or might not secure properly.

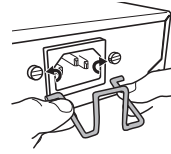

Insert the included clamp from the inside of the holes in the unit.

2. Connect the included power cord to the power inlet, and secure it with the clamp.

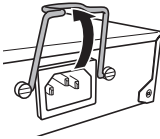

2-1 Raise the clamp.

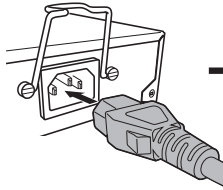

2-2 Connect the power cord.

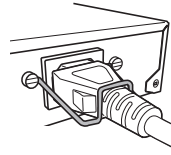

2-3 Press down on the clamp to secure the power cord.

3. Connect the power cord to an electrical outlet.

The POWER indicator flashes green, and after startup is completed, is lit green.



Caution

If the POWER indicator is lit orange, the fans have stopped or the temperature inside the unit is abnormal. Verify the status of the problem, and take the appropriate action.

- Fan stopped
The fan that exhausts the heat dissipated by this unit has stopped. You must immediately stop using the unit, and contact a Yamaha service center listed at the end of this manual to have the unit repaired or inspected.
- Abnormal temperature inside this unit.
Reconsider the environment in which this unit is installed, and correctly install this unit so that its internal temperature is appropriate.

4. Check the port indicators.

Using the MODE button, switch the display mode and check the port indicators.

For details on switching the display mode, the connection status, and the power supply status, refer to “Switching the display mode” (page 16) and “Port indicators” (page 17).

Initialization

This unit can be restored to its factory-set state in the following ways.

- Using the Web GUI to restore the factory settings (page 31)
- Using the cold start command to restore the factory settings (page 32)
- Entering the <I> (uppercase I) key during startup to restore the factory settings (page 32)

Notice

When restoring the factory settings, note the following points.

- All communication is halted immediately after execution.
- When you execute this, the settings will also return to their factory-set state. If necessary, use external memory to save the settings before you proceed with initialization. For details on how to export settings to external memory, refer to the SWR2311P-10G's "Technical Reference."

■ Using the Web GUI to restore the factory settings

This unit can be restored to its factory-set state by making settings from the Web GUI.

Log in to the Web GUI from Yamaha LAN Monitor.

1. Choose "Management" tab – "Maintenance" – "Restart and initialize."

The "Restart or Initialize" screen appears.

2. In the "Initialize" section, click the "Next" button.

The "Initialize" screen appears.

3. Enter the administrative password, and click the "OK" button.

The "Check executed content" screen appears.

4. Verify the content, and click the "Execute" button.

The unit is returned to its factory-set state. Then, the "Initialization" dialog box appears, and the unit restarts.

5. After this unit has finished restarting, access the Web GUI once again from Yamaha LAN Monitor.

NOTE

During restart, the computer on which the Web GUI is open will be unable to communicate with the unit (the status indication of the computer's network adapter will be "Network cable is not connected"), but the communication status will recover when restart is completed. After this unit's POWER indicator has finished flashing, verify that communication has been restored for the computer on which the Web GUI is open, and then click the Web GUI button in the "Device Details" view.

Initialization

■ Using the cold start command to restore the factory settings

You can return the unit to its factory settings by using a command line setting via the CONSOLE port, Telnet, or an SSH client.

Here we assume that you are logged in as described in “Logging in from a computer connected to the CONSOLE port” (page 27).

1. Enter enable, and press the <Enter> key.

You are now in privileged EXEC mode.

```
SWR2311P>enable
SWR2311P#
```

2. Enter the cold start command, and press the <Enter> key.

You will be asked to enter the administrative password.

If a password has already been specified, enter the password.

When the unit is shipped from the factory, a password has not been specified, so it need not be entered.

```
SWR2311P#cold start
Password:
```

3. Press the <Enter> key.

The unit returns to the factory-set state, and then restarts.

■ Entering the <I> (uppercase I) key during startup to restore the factory settings

The unit can be restored to its factory settings by entering an uppercase <I> when the unit is starting up. This explanation uses the method of disconnecting and reconnecting the power cord. The procedure is also the same when using the reload command to restart this unit.

Notice

Here we assume that you are logged in as described in “Logging in from a computer connected to the CONSOLE port” (page 27).

1. Disconnect and then reconnect the power cord of this unit.

2. During restart, enter an uppercase <I> within one second after the BootROM Ver (see below) appears on the console screen.

```
SWR2311P BootROM Ver.1.00
```

3. When a screen asks you whether to execute initialization, press the <y> key to execute initialization.

```
Initialize or not?(y/n)
```

Initialization is executed.

```
Ready to Initialize
.....
```

Appendix

Hardware specifications

Item		Specifications
Dimensions (not including protrusions and feet)		220 mm (W) x 294 mm (D) x 42.4 mm (H)
Weight (without accessories)		2.3 kg
Power supply voltage and frequency		AC100-240 V, 50/60 Hz
Maximum power consumption		280 W
LAN ports equipped with PoE supply capability	Standard	IEEE 802.3 (10BASE-T/100BASE-TX/1000BASE-T)
	Number of ports	8 ports
	Communication mode	Auto negotiation
	Connector type	RJ-45
	MAC address	Printed on top surface label
	Polarity	Straight/cross automatic detection
Combo ports	LAN ports	IEEE 802.3 (1000BASE-T) 2 ports (use is mutually exclusive with SFP ports)
	SFP ports	SFP (Small Form-factor Pluggable) 2 ports (use is mutually exclusive with LAN ports)
PoE	Standard	IEEE 802.3at
	Power supply system	Alternative A
	Maximum power supply	30 W / port, 240 W / entire unit
microSD slot	Standard	SD/SDHC
	Number of slots	1 slot
CONSOLE port	Standard	RS-232C, USB 2.0
	Connector type	RJ-45, USB mini-B (5-pin)
	Data transmission speed	9600 bit/s
Indicators		POWER, microSD, LED MODE, LAN port, SFP port
Operating environment conditions	Ambient temperature	0–40 °C
	Ambient humidity	15–80%, non-condensing

RJ-45/DB-9 console cable pin configuration

Console (RS-232C)

Signal	RJ-45	D-SUB 9
		9
RTS	1	8
DTR	2	6
TxD	3	2
GND	4	5
GND	5	
RxD	6	3
DSP*	7	7
CTS*	8	4
		1

* These signals are not used by the SWR2311P-10G.

Software license agreement

This License Agreement (the “AGREEMENT”) is a legal agreement between you and Yamaha Corporation (“YAMAHA”) under which YAMAHA is providing the firmware of YAMAHA’s network products (the “PRODUCT”) and related software program, documentation and electronic files (collectively, the “SOFTWARE”).

YAMAHA grants you a personal non-exclusive license to use the SOFTWARE only for purposes of running it on the PRODUCT.

This AGREEMENT applies to the SOFTWARE which YAMAHA provides you and the installed copy thereof, subject to the provision of 1-1 herein, into the PRODUCT or personal computer owned by you.

1. GRANT OF LICENSE:

- 1-1. YAMAHA grants you a personal non-exclusive license to install the SOFTWARE and use the SOFTWARE on the PRODUCT or other devices, including but not limited to the personal computer, which you own.
- 1-2. You shall not assign, sublicense, sell, rent, lease, loan, convey or otherwise transfer to any third party, upload to a website or a server computer to which specified or unspecified persons may access, or copy, duplicate, translate or convert to another programming language the SOFTWARE except as expressly provided herein. You shall not alter, modify, disassemble, decompile or otherwise reverse engineer the SOFTWARE and you also shall not have any third party to do so.
- 1-3. You shall not modify, remove or delete a copyright notice of YAMAHA contained in the SOFTWARE.
- 1-4. Except as expressly provided herein, no license or right, express or implied, is hereby conveyed or granted by YAMAHA to you for any intellectual property of YAMAHA.

2. OWNERSHIP AND COPYRIGHT:

The SOFTWARE is protected under the copyright laws and owned by YAMAHA. You agree and acknowledge that YAMAHA transfers neither ownership interest nor intellectual property in the SOFTWARE to you under this AGREEMENT or otherwise.

Appendix

3. EXPORT RESTRICTIONS:

You agree to comply with all applicable export control laws and regulations of the country involved, and not to export or re-export, directly or indirectly, the SOFTWARE in violation of any such laws and regulations.

4. SUPPORT AND UPDATE:

YAMAHA, YAMAHA's subsidiaries and affiliates, their distributors and dealers are not responsible for maintaining or helping you to use the SOFTWARE. No updates, bug-fixes or support will be made available to you for the SOFTWARE.

5. DISCLAIMER OF WARRANTY:

- 5-1. THE SOFTWARE IS PROVIDED "AS IS" WITHOUT WARRANTY OF ANY KIND, EITHER EXPRESS OR IMPLIED, INCLUDING, BUT NOT LIMITED TO THE IMPLIED WARRANTIES OF MERCHANTABILITY AND FITNESS FOR A PARTICULAR PURPOSE.
- 5-2. IN NO EVENT SHALL YAMAHA, YAMAHA'S SUBSIDIARIES AND AFFILIATES, THEIR DISTRIBUTORS AND DEALERS BE LIABLE FOR ANY DAMAGES WHATSOEVER (INCLUDING WITHOUT LIMITATION, LOSS OF BUSINESS PROFITS, LOSS OF BUSINESS INFORMATION, LOSS OF BUSINESS INTERRUPTION OR OTHER INCIDENTAL OR CONSEQUENTIAL DAMAGES) ARISING OUT OF THE SOFTWARE, USE THEREOF, OR INABILITY TO USE THEREOF EVEN IF YAMAHA, YAMAHA'S SUBSIDIARIES AND AFFILIATES, THEIR DISTRIBUTORS OR DEALERS HAVE BEEN ADVISED OF THE POSSIBILITY OF SUCH DAMAGES. SOME STATES DO NOT ALLOW THE LIMITATION OR EXCLUSION OF LIABILITY FOR INCIDENTAL OR CONSEQUENTIAL DAMAGES, SO THE ABOVE LIMITATION OR EXCLUSION MAY NOT APPLY TO YOU. SOME STATES DO NOT ALLOW THE LIMITATION OR EXCLUSION OF LIABILITY FOR INCIDENTAL OR CONSEQUENTIAL DAMAGES, SO THE ABOVE LIMITATION OR EXCLUSION MAY NOT APPLY TO YOU.
- 5-3. YAMAHA, YAMAHA'S SUBSIDIARIES AND AFFILIATES, THEIR DISTRIBUTORS AND DEALERS SHALL HAVE NO OBLIGATION TO INDEMNIFY YOU AGAINST ANY CLAIM OR SUIT BROUGHT BY A THIRD PARTY ALLEGING THAT THE SOFTWARE OR USE THEREOF INFRINGES ANY INTELLECTUAL PROPERTY OF SUCH THIRD PARTY.

6. TERM:

- 6-1. This AGREEMENT becomes effective upon your agreeing to the terms and conditions herein and continues in effect unless or until terminated in accordance with the provision of 6-2 or 6-3 herein.
- 6-2. You may terminate this AGREEMENT by deleting the SOFTWARE installed into the PRODUCT.
- 6-3. This AGREEMENT will also terminate if you fail to comply with any of the terms and conditions of this AGREEMENT.
- 6-4. In case this AGREEMENT is terminated in accordance with the provision 6-3, you shall promptly delete the SOFTWARE.
- 6-5. Notwithstanding anything contains herein, Sections 2 through 6 shall survive any termination or expiration hereof.

7. SEPARABILITY:

In the event that any provision of this AGREEMENT is declared or found to be illegal by any court or tribunal of competent jurisdiction, such provision shall be null and void with respect to the jurisdiction of that court or tribunal and all the remaining provisions of this AGREEMENT shall remain in full force and effect.

8. U.S. GOVERNMENT RESTRICTED RIGHTS NOTICE:

The Software is a “commercial item,” as that term is defined at 48 C.F.R. 2.101 (Oct 1995), consisting of “commercial computer software” and “commercial computer software documentation,” as such terms are used in 48 C.F.R. 12.212 (Sept 1995). Consistent with 48 C.F.R. 12.212 and 48 C.F.R. 227.7202-1 through 227.72024 (June 1995), all U.S. Government End Users shall acquire the Software with only those rights set forth herein.

9. ACKNOWLEDGMENT:

You agree that this AGREEMENT is the complete and exclusive statement of agreement between you and YAMAHA concerning the subject matter hereof and supersedes all proposals or prior agreements, verbal or written, and any other communications between you and the parties relating to the subject matter hereof. NO amendment to this AGREEMENT shall be effective unless signed by a duly authorized representative of YAMAHA.

10. GOVERNING LAW:

This AGREEMENT shall be governed by and construed in accordance with the laws of Japan without reference to the principles of conflict of laws.

Index

C

Command line.....	26
CONSOLE port.....	26
Cooling vents.....	13

D

Display mode.....	16
LINK/ACT mode.....	17
OFF mode.....	19
PoE mode.....	18
STATUS mode.....	18
VLAN mode.....	18

F

Fans.....	14
-----------	----

I

Initialization.....	31
---------------------	----

L

LAN ports.....	12
LAN/SFP combo ports.....	12
Leg.....	15
Leg attachment guides.....	15

M

microSD indicator.....	12
microSD slot.....	12
mini-USB CONSOLE port.....	11, 26
MODE button.....	12
MODE indicator.....	12

P

Password.....	25
Power cord clamp.....	30
Power cord clamp attachment holes.....	14
POWER indicator.....	11
Power supply inlet.....	14
Product label.....	13

R

Rack mount accessory attachment holes.....	15
RJ-45 CONSOLE port.....	12
RK-SWR.....	20

S

SFP module.....	28
-----------------	----

U

User name.....	25
----------------	----

W

Wall mount accessory attachment holes.....	16
Web GUI.....	25
WK-SWR.....	22

Y

Yamaha LAN Monitor.....	10
Yamaha Network USB Serial Driver ...	10, 26

Memo

Important Notice: Guarantee Information for customers in European Economic Area (EEA) and Switzerland

<p>Important Notice: Guarantee Information for customers in EEA* and Switzerland</p> <p>For detailed guarantee information about this Yamaha product, and Pan-EEA* and Switzerland warranty service, please either visit the website address below (Printable file is available at our website) or contact the Yamaha representative office for your country. * EEA: European Economic Area</p>	English
<p>Wichtiger Hinweis: Garantie-Information für Kunden in der EWR* und der Schweiz</p> <p>Für nähere Garantie-Information über dieses Produkt von Yamaha, sowie über den Pan-EWR*- und Schweizer Garantieservice, besuchen Sie bitte entweder die folgende angegebene Internetadresse (eine druckfähige Version befindet sich auf unserer Webseite), oder wenden Sie sich an den für Ihr Land zuständigen Yamaha-Vertrieb. *EWR: Europäischer Wirtschaftsraum</p>	Deutsch
<p>Remarque importante: Informations de garantie pour les clients de l'EEE et la Suisse</p> <p>Pour des informations plus détaillées sur la garantie de ce produit Yamaha et sur le service de garantie applicable dans l'ensemble de l'EEE ainsi qu'en Suisse, consultez notre site Web à l'adresse ci-dessous (le fichier imprimable est disponible sur notre site Web) ou contactez directement Yamaha dans votre pays de résidence. * EEE: Espace Economique Européen</p>	Français
<p>Belangrijke mededeling: Garantie-informatie voor klanten in de EER* en Zwitserland</p> <p>Voor gedetailleerde garantie-informatie over dit Yamaha-product en de garantieservice in heel de EER* en Zwitserland, gaat u naar de onderstaande website (u vindt een afdrukbaar bestand op onze website) of neemt u contact op met de vertegenwoordiging van Yamaha in uw land. * EER: Europese Economische Ruimte</p>	Nederlands
<p>Aviso importante: información sobre la garantía para los clientes del EEE* y Suiza</p> <p>Para una información detallada sobre este producto Yamaha y sobre el soporte de garantía en la zona EEE* y Suiza, visite la dirección web que se incluye más abajo (la versión del archivo para imprimir está disponible en nuestro sitio web) o póngase en contacto con el representante de Yamaha en su país. * EEE: Espacio Económico Europeo</p>	Español
<p>Avviso importante: informazioni sulla garanzia per i clienti residenti nell'EEA* e in Svizzera</p> <p>Per informazioni dettagliate sulla garanzia relativa a questo prodotto Yamaha e l'assistenza in garanzia nei paesi EEA* e in Svizzera, potete consultare il sito Web all'indirizzo riportato di seguito (è disponibile il file in formato stampabile) oppure contattare l'ufficio di rappresentanza locale della Yamaha. * EEA: Area Economica Europea</p>	Italiano
<p>Aviso importante: informações sobre as garantias para clientes da AEE* e da Suíça</p> <p>Para obter uma informação pormenorizada sobre este produto da Yamaha e sobre o serviço de garantia na AEE* e na Suíça, visite o site a seguir (o arquivo para impressão está disponível no nosso site) ou entre em contato com o escritório de representação da Yamaha no seu país. * AEE: Área Económica Europeia</p>	Português
<p>Σημαντική σημείωση: Πληροφορίες εγγύησης για τους πελάτες στον ΕΟΧ* και Ελλάδα</p> <p>Για λεπτομερείς πληροφορίες εγγύησης σχετικά με το παρόν προϊόν της Yamaha και την κάλυψη εγγύησης σε όλες τις χώρες του ΕΟΧ και την Ελλάδα, επισκεφτείτε την παρακάτω ιστοσελίδα (Εκτυπώσιμη μορφή είναι διαθέσιμη στην ιστοσελίδα μας) ή απευθυνθείτε στην αντιπροσωπεία της Yamaha στη χώρα σας. * ΕΟΧ: Ευρωπαϊκός Οικονομικός Χώρος</p>	Ελληνικά
<p>Viktigt: Garantiinformation för kunder i EES-området* och Schweiz</p> <p>För detaljerad information om denna Yamahaprodukt samt garantiservice i hela EES-området* och Schweiz kan du antingen besöka nedanstående webbadress (en utskriftsvänlig fil finns på webbplatsen) eller kontakta Yamahas officiella representant i ditt land. * EES: Europeiska Ekonomiska Samarbetsområdet</p>	Svenska
<p>Viktig merknad: Garantiinformasjon for kunder i EØS* og Sveits</p> <p>Detaljert garantiinformasjon om dette Yamaha-produktet og garantieservice for hele EØS-området* og Sveits kan fås enten ved å besøke nettstedene nedenfor (utskriftsversjon finnes på våre nettsider) eller kontakte Yamahas offisielle representant i landet der du bor. *EØS: Det europeiske økonomiske samarbeidsområdet</p>	Norsk
<p>Viktig oplysning: Garantioplysninger til kunder i EØ* og Schweiz</p> <p>De kan finde detaljerede garantioplysninger om dette Yamaha-produkt og den fælles garantioplysning for EØ* (og Schweiz) ved at besøge det websted, der er angivet nedenfor (der findes en fil, som kan udskrives, på vores websted), eller ved at kontakte Yamahas nationale repræsentationskontor i det land, hvor De bor. * EØ: Det Europæiske Økonomiske Område</p>	Dansk
<p>Tärkeä ilmoitus: Takuutiedot Euroopan talousalueen (ETA)* ja Sveitsin asiakkaille</p> <p>Tämän Yamaha-tuotteen sekä ETA-alueen ja Sveitsin takuuta koskevat yksityiskohtaiset tiedot saatte alla olevasta nettiosoitteesta. (Tulostettava tiedosto saatavissa sivustollamme.) Voitille myös ottaa yhteyttä paikalliseen Yamaha-edustajaan. *ETA: Euroopan talousalue</p>	Suomi
<p>Ważne: Warunki gwarancyjne obowiązujące w EOG* i Szwajcarii</p> <p>Aby dowiedzieć się więcej na temat warunków gwarancyjnych tego produktu firmy Yamaha i serwisu gwarancyjnego w całym EOG* i Szwajcarii, należy odwiedzić wskazaną poniżej stronę internetową (Plik gotowy do wydruku znajduje się na naszej stronie internetowej) lub skontaktować się z przedstawicielstwem firmy Yamaha w swoim kraju. * EOG — Europejski Obszar Gospodarczy</p>	Polski
<p>Důležité oznámení: Záruční informace pro zákazníky v EHS* a ve Švýcarsku</p> <p>Podrobné záruční informace o tomto produktu Yamaha a záručním servisu v celém EHS* a ve Švýcarsku naleznete na níže uvedené webové adrese (soubor k tisku je dostupný na našich webových stránkách) nebo se můžete obrátit na zastupovní firmu Yamaha ve své zemi. * EHS: Evropský hospodářský prostor</p>	Česky
<p>Fontos figyelemzés: Garancia-információk az EGT* területén és Svájcban élő vásárlók számára</p> <p>A jelen Yamaha termékre vonatkozó részletes garancia-információk, valamint az EGT*-re és Svájcra kiterjedő garanciális szolgáltatás tekintetében keressse fel webhelyünket az alábbi címen (a webhelyen nyomatható fájl is talál), vagy pedig lépjen kapcsolatba az országában működő Yamaha képviselői iróddal. * EGT: Európai Gazdasági Térség</p>	Magyar
<p>Oluline märkus: Garantiteave Euroopa Majanduspiirkonna (EMP)* ja Šveitsi klientidele</p> <p>Täpsemat teabe saamiseks selle Yamaha toote garantii ning kogu Euroopa Majanduspiirkonna ja Šveitsi garantiteeninduse kohta, külastage palun veebisaiti alljärgneval aadressil (meie saitil on saadaval printitav fail) või pöörduge Teie regiooni Yamaha esinduse poole. * EMP: Euroopa Majanduspiirkond</p>	Eesti keel
<p>Svarīgs paziņojums: garantijas informācija klientiem EEZ* un Šveicā</p> <p>Lai saņemtu detalizētu garantijas informāciju par šo Yamaha produktu, kā arī garantijas apkalpošanu EEZ* un Šveicā, ielūdzam apmeklēt zemāk norādīto tīmekļa vietnes adresi (tīmekļa vietnē ir pieejams drukājams fails) vai sazināties ar Jūsu valsti apkalpojošo Yamaha pārstāvniecību. * EEZ: Eiropas Ekonomikas zona</p>	Latviešu
<p>Děmosio: informacija dėl garantijos pirkėjams EEE* ir Šveicarijoje</p> <p>Jei reikia išsamios informacijos apie šį „Yamaha“ produktą ir jo techninę priežiūrą visoje EEE* ir Šveicarijoje, apsilankykite mūsų svetainėje toliau nurodytu adresu (svetainėje yra spausdinamas failas) arba kreipkitės į „Yamaha“ atstovybę savo šalyje. * EEE – Europos ekonominė erdvė</p>	Lietuvių kalba
<p>Dôležité upozornenie: Informácie o záruke pre zákazníkov v EHP* a Švajčiarsku</p> <p>Podrobné informácie o záruke týkajúcej sa tohto produktu od spoločnosti Yamaha a garančnom servise v EHP* a Švajčiarsku nájdete na webovej stránke uvedenej nižšie (na našej webovej stránke je k dispozícii súbor na tlač) alebo sa obráťte na zástupcu spoločnosti Yamaha vo svojej krajine. * EHP: Európsky hospodársky priestor</p>	Slovenčina
<p>Pomembno obvestilo: Informacije o garanciji za kupce v EGP* in Švici</p> <p>Za podrobne informacije o tem Yamahinem izdelku ter garancijskem servisu v celotnem EGP in Švici, obiščite spletno mesto, ki je navedeno spodaj (natisljiva datoteka je na voljo na našem spletnem mestu), ali se obrnite na Yamahinega predstavnika v svoji državi. * EGP: Evropski gospodarski prostor</p>	Slovensčina
<p>Важно съобщение: Информация за гаранцията за клиенти в ЕИП* и Швейцария</p> <p>За подробна информация за гаранцията за този продукт на Yamaha и гаранционното обслужване в паневропейската зона на ЕИП* и Швейцария или посетете посочения по-долу уеб сайт (на нашия уеб сайт има файл за печат), или се свържете с представителния офис на Yamaha във вашата страна. * ЕИП: Европейския икономически пространство</p>	Български език
<p>Notificare importantă: Informații despre garanție pentru clienții din SEE* și Elveția</p> <p>Pentru informații detaliate privind acest produs Yamaha și serviciul de garanție Pan-SEE* și Elveția, vizitați site-ul la adresa de mai jos (fișierul imprimabil este disponibil pe site-ul nostru) sau contactați biroul reprezentanței Yamaha din țara dumneavoastră. * SEE: Spațiul Economic European</p>	Limba română

<http://europe.yamaha.com/warranty/>

URL_4

Information for users on collection and disposal of old equipment:



This symbol on the products, packaging, and/or accompanying documents means that used electrical and electronic products should not be mixed with general household waste. For proper treatment, recovery and recycling of old products, please take them to applicable collection points, in accordance with your national legislation.

By disposing of these products correctly, you will help to save valuable resources and prevent any potential negative effects on human health and the environment which could otherwise arise from inappropriate waste handling.

For more information about collection and recycling of old products, please contact your local municipality, your waste disposal service or the point of sale where you purchased the items.

For business users in the European Union:

If you wish to discard electrical and electronic equipment, please contact your dealer or supplier for further information.

Information on Disposal in other Countries outside the European Union:

This symbol is only valid in the European Union. If you wish to discard these items, please contact your local authorities or dealer and ask for the correct method of disposal.

(weee_eu_en_02)

Verbraucherinformation zur Sammlung und Entsorgung alter Elektrogeräte



Befindet sich dieses Symbol auf den Produkten, der Verpackung und/oder beiliegenden Unterlagen, so sollten benutzte elektrische Geräte nicht mit dem normalen Haushaltsabfall entsorgt werden. In Übereinstimmung mit Ihren nationalen Bestimmungen bringen Sie alte Geräte bitte zur fachgerechten Entsorgung, Wiederaufbereitung und Wiederverwendung zu den entsprechenden Sammelstellen.

Durch die fachgerechte Entsorgung der Elektrogeräte helfen Sie, wertvolle Ressourcen zu schützen, und verhindern mögliche negative Auswirkungen auf die menschliche Gesundheit und die Umwelt, die andernfalls durch unsachgerechte Müllentsorgung auftreten könnten.

Für weitere Informationen zum Sammeln und Wiederaufbereiten alter Elektrogeräte kontaktieren Sie bitte Ihre örtliche Stadt- oder Gemeindeverwaltung, Ihren Abfallentsorgungsdienst oder die Verkaufsstelle der Artikel.

Information für geschäftliche Anwender in der Europäischen Union:

Wenn Sie Elektrogeräte ausrangieren möchten, kontaktieren Sie bitte Ihren Händler oder Zulieferer für weitere Informationen.

Entsorgungsinformation für Länder außerhalb der Europäischen Union:

Dieses Symbol gilt nur innerhalb der Europäischen Union. Wenn Sie solche Artikel ausrangieren möchten, kontaktieren Sie bitte Ihre örtlichen Behörden oder Ihren Händler und fragen Sie nach der sachgerechten Entsorgungsmethode.

(weee_eu_de_02)

Informations concernant la collecte et le traitement des déchets d'équipements électriques et électroniques



Le symbole sur les produits, l'emballage et/ou les documents joints signifie que les produits électriques ou électroniques usagés ne doivent pas être mélangés avec les déchets domestiques habituels. Pour un traitement, une récupération et un recyclage appropriés des déchets d'équipements électriques et électroniques, veuillez les déposer aux points de collecte prévus à cet effet, conformément à la réglementation nationale.

En vous débarrassant correctement des déchets d'équipements électriques et électroniques, vous contribuerez à la sauvegarde de précieuses ressources et à la prévention de potentiels effets négatifs sur la santé humaine qui pourraient advenir lors d'un traitement inapproprié des déchets.

Pour plus d'informations à propos de la collecte et du recyclage des déchets d'équipements électriques et électroniques, veuillez contacter votre municipalité, votre service de traitement des déchets ou le point de vente où vous avez acheté les produits.

Pour les professionnels dans l'Union européenne :

Si vous souhaitez vous débarrasser des déchets d'équipements électriques et électroniques, veuillez contacter votre vendeur ou fournisseur pour plus d'informations.

Informations sur la mise au rebut dans d'autres pays en dehors de l'Union européenne :

Ce symbole est seulement valable dans l'Union européenne. Si vous souhaitez vous débarrasser de déchets d'équipements électriques et électroniques, veuillez contacter les autorités locales ou votre fournisseur et demander la méthode de traitement appropriée.

(weee_eu_fr_02)

Información para usuarios sobre la recogida y eliminación de los equipos antiguos



Este símbolo en los productos, embalajes y documentos anexos significa que los productos eléctricos y electrónicos no deben mezclarse con los desperdicios domésticos normales.

Para el tratamiento, recuperación y reciclaje apropiados de los productos antiguos, llévelos a puntos de reciclaje correspondientes, de acuerdo con la legislación nacional.

Al deshacerse de estos productos de forma correcta, ayudará a ahorrar recursos valiosos y a impedir los posibles efectos desfavorables en la salud humana y en el entorno que de otro modo se producirían si se trataran los desperdicios de modo inapropiado.

Para obtener más información acerca de la recogida y el reciclaje de los productos antiguos, póngase en contacto con las autoridades locales, con el servicio de eliminación de basuras o con el punto de venta donde adquirió los artículos.

Para los usuarios empresariales de la Unión Europea:

Si desea desechar equipos eléctricos y electrónicos, póngase en contacto con su vendedor o proveedor para obtener más información.

Información sobre la eliminación en otros países fuera de la Unión Europea:

Este símbolo solo es válido en la Unión Europea. Si desea desechar estos artículos, póngase en contacto con las autoridades locales o con el vendedor y pregúnteles el método correcto.

(weee_eu_es_02)

Informazioni per gli utenti sulla raccolta e lo smaltimento di vecchia attrezzatura



Questi simboli sui prodotti, sull'imballaggio e/o sui documenti che li accompagnano, indicano che i prodotti elettrici ed elettronici non devono essere mischiati con i rifiuti generici.

Per il trattamento, il recupero e il riciclaggio appropriato di vecchi prodotti, si prega di portarli ai punti di raccolta designati, in accordo con la legislazione locale.

Smaltendo correttamente questi prodotti si potranno recuperare risorse preziose, oltre a prevenire potenziali effetti negativi sulla salute e l'ambiente che potrebbero sorgere a causa del trattamento improprio dei rifiuti.

Per ulteriori informazioni sulla raccolta e il riciclaggio di vecchi prodotti, si prega di contattare l'amministrazione comunale locale, il servizio di smaltimento dei rifiuti o il punto vendita dove sono stati acquistati gli articoli.

Per utenti imprenditori dell'Unione europea:

Se si desidera scartare attrezzatura elettrica ed elettronica, si prega di contattare il proprio rivenditore o il proprio fornitore per ulteriori informazioni.

Informazioni sullo smaltimento negli altri Paesi al di fuori dell'Unione europea:

Questi simboli sono validi solamente nell'Unione Europea; se si desidera scartare questi articoli, si prega di contattare le autorità locali o il rivenditore e richiedere informazioni sulla corretta modalità di smaltimento.

(weee_eu_it_02)

ADDRESS LIST

NORTH AMERICA

CANADA

Yamaha Canada Music Ltd.
135 Milner Avenue, Toronto, Ontario,
M1S 3R1, Canada
Tel: +1-416-298-1311

U.S.A.

Yamaha Corporation of America
6600 Orangethorpe Avenue, Buena Park, CA 90620,
U.S.A.
Tel: +1-714-522-9011

CENTRAL & SOUTH AMERICA

MEXICO

Yamaha de México, S.A. de C.V.
Av. Insurgentes Sur 1647 Piso 9, Col. San José
Insurgentes, Delegación Benito Juárez, México,
D.F., C.P. 03900, México
Tel: +52-55-5804-0600

BRAZIL

Yamaha Musical do Brasil Ltda.
Rua Fidêncio Ramos, 302 – Cj 52 e 54 – Torre B – Vila
Olímpia – CEP 04551-010 – São Paulo/SP, Brazil
Tel: +55-11-3704-1377

ARGENTINA

**Yamaha Music Latin America, S.A.,
Sucursal Argentina**
Olga Cossetini 1553, Piso 4 Norte,
Madero Este-C1107CEK,
Buenos Aires, Argentina
Tel: +54-11-4119-7000

PANAMA AND OTHER LATIN AMERICAN COUNTRIES/ CARIBBEAN COUNTRIES

Yamaha Music Latin America, S.A.
Edif. Torre Banco General, Piso 7, Urbanización
Marbella, Calle 47 y Aquilino de la Guardia,
Ciudad de Panamá, República de Panamá
Tel: +507-269-5311

EUROPE

THE UNITED KINGDOM/IRELAND

Yamaha Music Europe GmbH (UK)
Sherbourne Drive, Tilbrook, Milton Keynes,
MK7 8BL, U.K.
Tel: +44-1908-366700

GERMANY

Yamaha Music Europe GmbH
Siemensstrasse 22-34, 25462 Rellingen, Germany
Tel: +49-4101-303-0

SWITZERLAND/LIECHTENSTEIN

**Yamaha Music Europe GmbH, Branch
Switzerland in Thalwil**
Seestrasse 18a, 8800 Thalwil, Switzerland
Tel: +41-44-3878080

AUSTRIA/BULGARIA/ CZECH REPUBLIC/HUNGARY/ ROMANIA/SLOVAKIA/SLOVENIA

**Yamaha Music Europe GmbH
Branch Austria**
Schleiergasse 20, 1100 Wien, Austria
Tel: +43-1-60203900

POLAND

Yamaha Music Europe GmbH
Sp.z o.o. Oddział w Polsce
ul. Wielicka 52, 02-655 Warszawa, Poland
Tel: +48-22-880-08-88

MALTA

Olimpus Music Ltd.
Valletta Road, Mosta MST9010, Malta
Tel: +356-2133-2093

NETHERLANDS/BELGIUM/ LUXEMBOURG

Yamaha Music Europe Branch Benelux
Clarissenhof 5b, 4133 AB Vianen, The Netherlands
Tel: +31-347-358040

FRANCE

Yamaha Music Europe
7 rue Ambroise Croizat, Zone d'activités de Pariest,
77183 Croissy-Beaubourg, France
Tel: +33-1-6461-4000

ITALY

Yamaha Music Europe GmbH, Branch Italy
Via Tinelli N.67/69 20855 Gerno di Lesmo (MB),
Italy
Tel: +39-039-9065-1

SPAIN/PORTUGAL

**Yamaha Music Europe GmbH Ibérica, Sucursal
en España**
Ctra. de la Coruña km. 17,200, 28231
Las Rozas de Madrid, Spain
Tel: +34-91-639-88-88

GREECE

Philippou Nakas S.A. The Music House
19th km. Leof. Lavriou 190 02 Peania – Attiki,
Greece
Tel: +30-210-6686168

SWEDEN/FINLAND/ICELAND

**Yamaha Music Europe GmbH Germany filial
Scandinavia**
JA Wettergrensgata 1, 400 43 Göteborg, Sweden
Tel: +46-31-89-34-00

DENMARK

**Yamaha Music Denmark,
Filial of Yamaha Music Europe GmbH, Tyskland
Generatorvej 8C, ST. TH., 2860 Soborg, Denmark
Tel: +45-44-92-49-00**

NORWAY

**Yamaha Music Europe GmbH Germany -
Norwegian Branch**
Grini Næringspark 1, 1332 Østerås, Norway
Tel: +47-67-16-7800

CYPRUS

Yamaha Music Europe GmbH
Siemensstrasse 22-34, 25462 Rellingen, Germany
Tel: +49-4101-303-0

RUSSIA

Yamaha Music (Russia) LLC.
Room 37, entrance 7, bld. 7, Kievskaya street,
Moscow, 121059, Russia
Tel: +7-495-626-5005

OTHER EUROPEAN COUNTRIES

Yamaha Music Europe GmbH
Siemensstrasse 22-34, 25462 Rellingen, Germany
Tel: +49-4101-3030

AFRICA

Yamaha Music Gulf FZE
JAFZA-16, Office 512, P.O.Box 17328,
Jebel Ali FZE, Dubai, UAE
Tel: +971-4-801-1500

MIDDLE EAST

TURKEY

Yamaha Music Europe GmbH
Merkezi Almanya Türkiye Istanbul Şubesi
Mor Sumbul Sokak Varyap Meridian Business
1.Blok No:1 113-114-115
Bati Atasehir Istanbul, Turkey
Tel: +90-216-275-7960

OTHER COUNTRIES

Yamaha Music Gulf FZE
JAFZA-16, Office 512, P.O.Box 17328,
Jebel Ali FZE, Dubai, UAE
Tel: +971-4-801-1500

ASIA

THE PEOPLE'S REPUBLIC OF CHINA

Yamaha Music & Electronics (China) Co.,Ltd.
2F, Yunhedasha, 1818 Xinzha-lu, Jingan-qu,
Shanghai, China
Tel: +86-400-051-7700

INDIA

Yamaha Music India Private Limited
P-401, JMD Megapolis, Sector-48, Sohna Road,
Gurgaon-122018, Haryana, India
Tel: +91-124-485-3300

INDONESIA

PT. Yamaha Musik Indonesia (Distributor)
Yamaha Music Center Bldg. Jalan Jend. Gatot
Subroto Kav. 4, Jakarta 12930, Indonesia
Tel: +62-21-520-2577

KOREA

Yamaha Music Korea Ltd.
11F, Prudential Tower, 298, Gangnam-daero,
Gangnam-gu, Seoul, 06253, Korea
Tel: +82-2-3467-3300

MALAYSIA

Yamaha Music (Malaysia) Sdn. Bhd.
No.8, Jalan Perbandaran, Kelana Jaya, 47301
Petaling Jaya, Selangor, Malaysia
Tel: +60-3-78030900

SINGAPORE

Yamaha Music (Asia) Private Limited
Block 202 Hougang Street 21, #02-00,
Singapore 530202, Singapore
Tel: +65-6740-9200

TAIWAN

Yamaha Music & Electronics Taiwan Co.,Ltd.
2F, No.1, Yuandong Rd., Banqiao Dist.,
New Taipei City 22063, Taiwan (R.O.C.)
Tel: +886-2-7741-8888

THAILAND

Siam Music Yamaha Co., Ltd.
3, 4, 15, 16th Fl., Siam Motors Building,
891/1 Rama 1 Road, Wangmai,
Pathumwan, Bangkok 10330, Thailand
Tel: +66-2215-2622

VIETNAM

Yamaha Music Vietnam Company Limited
15th Floor, Nam A Bank Tower, 201-203 Cach
Mang Thang Tam St., Ward 4, Dist.3,
Ho Chi Minh City, Vietnam
Tel: +84-8-3818-1122

OTHER ASIAN COUNTRIES

<http://asia.yamaha.com/>

OCEANIA

AUSTRALIA

Yamaha Music Australia Pty. Ltd.
Level 1, 80 Market Street, South Melbourne,
VIC 3205, Australia
Tel: +61-3-9693-5111

COUNTRIES AND TRUST TERRITORIES IN PACIFIC OCEAN

<http://asia.yamaha.com/>

Yamaha Pro Audio global website
<https://www.yamaha.com/proaudio/>
Yamaha Downloads
<https://download.yamaha.com/>

Manual Development Group
© 2018 Yamaha Corporation

Published 06/2018 IPES-A0

ZZ29740