



▶▶ NEUMANN.BERLIN

Setting up Studio Monitors

Start with **excellent** products

Set them up **correctly**

Audio reproduction will be **accurate**

This leads to **better results**



Best Input. Best Output.

Table of Contents

Introduction	7
What types of loudspeaker are there (active, passive, DSP, etc.)?	8
What technologies are used in loudspeakers?	9
What is Neumann trying to achieve when designing a loudspeaker?	11
Does Neumann make specific products for different listening materials?	12
The loudspeaker-room interaction	13
Locating the loudspeaker's acoustical axis.....	14
Orientating the loudspeaker cabinet.....	15
Symmetry brings better imaging.....	16
Placing the loudspeakers at the correct angle.....	17
Placing the loudspeakers at the same distance.....	19
Delaying closer loudspeakers	20
Achieving a flatter treble.....	21
Achieving a smoother bass	22
Achieving a smoother midrange.....	23
Flattening the in-room response	25
Flush mounting larger cabinets.....	26
Adding subwoofers	27
Positioning subwoofers.....	28
Calibrating subwoofers	29
What cables are required?	30
Wiring the system	31
Bass management	32
Technology descriptions.....	34

Introduction

Dear Audio Aficionado,

This guide aims to give you a simple introduction to studio monitors and their setup.

We start with descriptions of the basic types of studio monitors, the technologies seen in these designs, and the requirements of a studio monitor.

Next, we move onto installing loudspeakers into a room: putting the loudspeaker cabinet in the best place and then optimizing the response of the loudspeaker.

Finally, we describe how subwoofers can improve the system's performance together with the essentials of installation: positioning, cabling and calibrating.

We hope you enjoy reading this guide and are able to extract useful information whatever products you may be using.

All the very best in your audio endeavors,

Neumann.Berlin



What types of loudspeaker are there (active, passive, DSP, etc.)?

The following basic types of loudspeaker design are commonly manufactured (Neumann does not make all of these types):

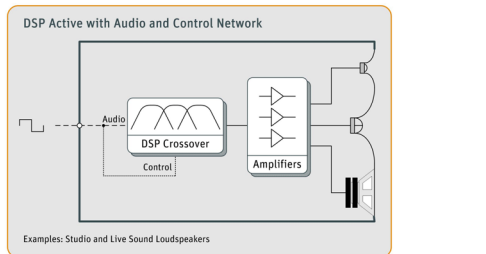
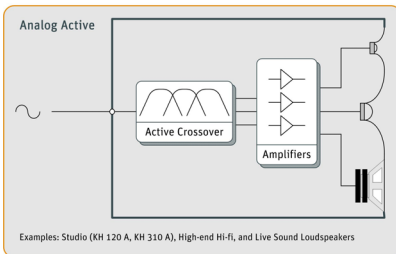
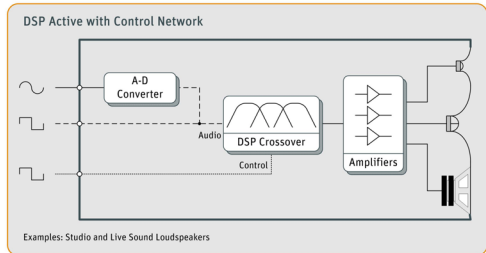
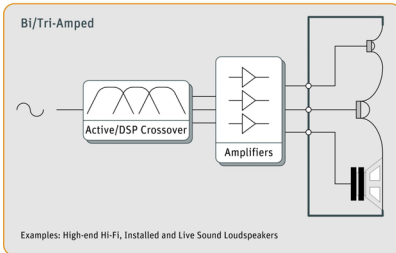
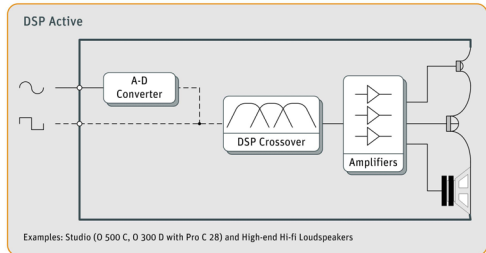
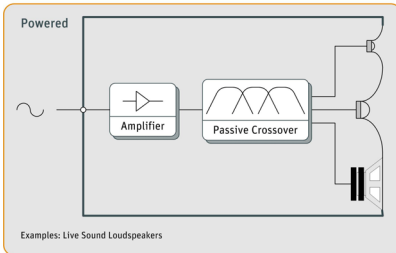
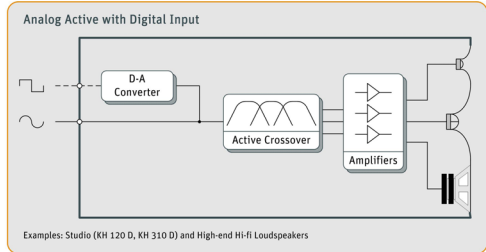
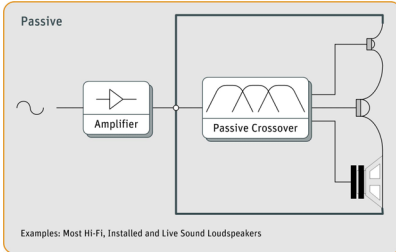



What technologies are used in loudspeakers?

The following technologies are commonly seen in the different types of loudspeaker designs on the market (Neumann does not use all of these technologies and some are used more often than others):

Inputs

- Analog: electronic-balanced, transformer-balanced, loudspeaker level: low impedance, high impedance (70 V, 100 V)
- Digital: S/P-DIF, AES3, Firewire, USB, audio network

Converters

- D-A: typically Oversampling or Interpolating used
- A-D: typically Sigma-Delta used
- SRC added if fixed-rate processing follows

Crossover/Processing

- Passive: 1st, 2nd, 3rd order
- Active: 2nd, 3rd, 4th order
- DSP: IIR with 4th, 6th, 8th order, FIR with any order up to 16, linear phase, non-linear compensation

Amplifiers

- Class A, B, AB, C, D, H

Power Supplies

- Fixed linear (transformer), switchable linear (transformer), universal (switched-mode)

Protection

- Passive: multifuse, relay + network, fuse, bimetal
- Active: inputs, amplifiers (thermal, short-circuit), drivers thermal limiting, excursion limiting
- DSP: look ahead limiters, power supply monitoring



Drivers

- High frequency (tweeter, top): soft dome, hard dome (aluminum, titanium, beryllium ceramic, diamond), ribbon, folded ribbon, compression, plasma.
- Midrange (squawker): soft dome, hard dome, hard cone, folded ribbon, compression.
- Low frequency (bass, woofer, subwoofer): paper, polypropylene, woven fiberglass, carbon fiber, Kevlar, aluminum.
- Drivers can be direct radiating or loaded (acoustical horn)

Cabinet

- Wood, plastic, metal, stone
- Sealed, bass reflex, band pass (with different orders), horns, push-pull (isobaric)



What is Neumann trying to achieve when designing a loudspeaker?

At the listening position, a loudspeaker should acoustically exactly reproduce the electrical input signal. Ideally the loudspeaker should have or be (in no particular order of importance):

- Flat free-field frequency response (magnitude) with opportunity for adjustment, or a response optimized for a known placement conditions (i.e. not flat free-field frequency response)
- Deep low-frequency cut-off
- No self-generated noise
- No harmonic distortion
- No intermodulation distortion
- No latency
- A flat group delay
- No resonances
- Control of the directivity
- A peak SPL suitable for the application
- Mechanically robust and mountable into the installation
- Sufficient heat management to work in a wide variety of ambient temperatures
- A suitable size and weight for the application
- Accept the given input signal format using an appropriate connector
- Self protecting from high input signals
- No missing or under-specified features for the application
- A suitable range of mounting hardware
- A complementary set of accessories for those that need additional features and facilities

Not all of these are possible in a single loudspeaker so trade-offs are required between the parameters. Appropriate balancing of parameters can make the difference between a good and a bad loudspeaker for a particular application. In addition, the classic engineering challenge is to make a solution for a problem using the available materials and technologies within a defined budget.



Does Neumann make specific products for different listening materials?

Our loudspeakers are all designed to have the same neutral sound quality. However, as mentioned on the previous page, engineering trade-offs are required between design parameters which creates performance differences between products. For example, small loudspeakers generally have a lower maximum SPL and a limited bass extension. Conversely, a larger loudspeaker will generally have a higher maximum SPL, a deeper bass extension and a lower distortion for a given replay level. How does this affect loudspeaker choice?

- If you listen loud, you need a larger loudspeaker.
- If you listen to bass heavy material, for example hip-hop, dance, or synthesized music, you need a loudspeaker with a deeper bass extension and a sufficiently high maximum SPL.
- If you listen to material with a large dynamic range, for example orchestral music or movies, you need a loudspeaker system with a high maximum SPL.
- If you watch action movies, you need a system capable of reproducing audio down to 20 Hz at a high SPL.

Subwoofers can be used to increase the main loudspeakers' maximum SPL and the system's low-frequency bass extension. This can satisfy the listener's requirements whilst using smaller main loudspeakers. See pages 27-33 for more information on adding subwoofers to the system.



The loudspeaker-room interaction

As the loudspeaker and its replay environment cannot be separated, the room is a very important component in the total sound heard at the listening position. The most important points to remember in room design are:

- Avoid parallel walls which lead to strong resonances.
- Aim for a low (0.2 to 0.4 seconds) and flat reverberation time. Do not over-damp mid-high frequencies and do not under-damp low frequencies.
- Minimize strong reflections that get back to listening position. Those that do should have 20 dB less level than the direct sound level.
- For good imaging, ensure left-right symmetry of the room, equipment, and loudspeaker positioning. See page 16.
- Diffusers are generally used at longer distances and positioned at the back of the room.
- Absorption will be more widely distributed around the room in a multichannel installation, rather than predominantly at the back in a two-channel stereo room.
- Flush-mounted loudspeakers should sit in a well-constructed heavy hard wall. See page 26.
- Position the loudspeakers at the correct angles (see international recommendations) and point towards the listening position (use the acoustical axis). See page 17/18.
- Calibrate the loudspeakers using a reliable acoustical measurement system or use the recommendations in the operating manual.
- A low noise floor is essential to avoid masking low-level details in the program material, such as reverberant decays.
- Rattles should be found and eliminated.

Further advice can be found in text books, magazines, and on the internet, although one has to verify that internet advice is relevant and accurate. There is no substitute for a good room designer.



Locating the loudspeaker's acoustical axis

The acoustical axis is a line normal to the loudspeaker's front panel along which the microphone was placed when tuning the loudspeaker's crossover during design.

Pointing the acoustical axis, in the horizontal and vertical planes, directly at the listening position or centre of the listening area will give the best measured and perceived sound quality.

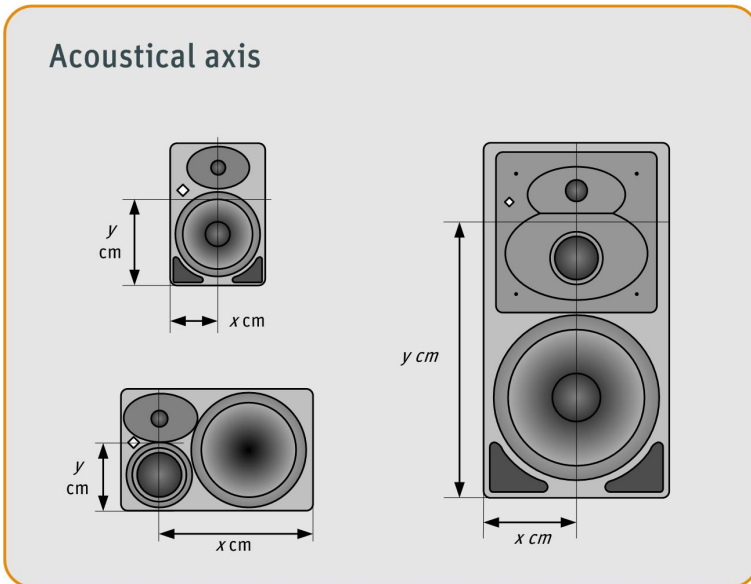

The acoustical axis dimensions can be found in the operating manual supplied with the product or on the Neumann Studio Monitoring website.



Orientating the loudspeaker cabinet

The recommended orientation for two-way loudspeakers is with the tweeter above or below the woofer. Try not to use a two-way loudspeaker horizontally.

The recommended orientation for compact three-way loudspeakers is with the tweeter above or below the woofer. Try not to use compact three-way loudspeakers vertically.

The recommended orientation for large three-way loudspeakers is with the tweeter above or below the woofer. Rotate the waveguide to achieve this.

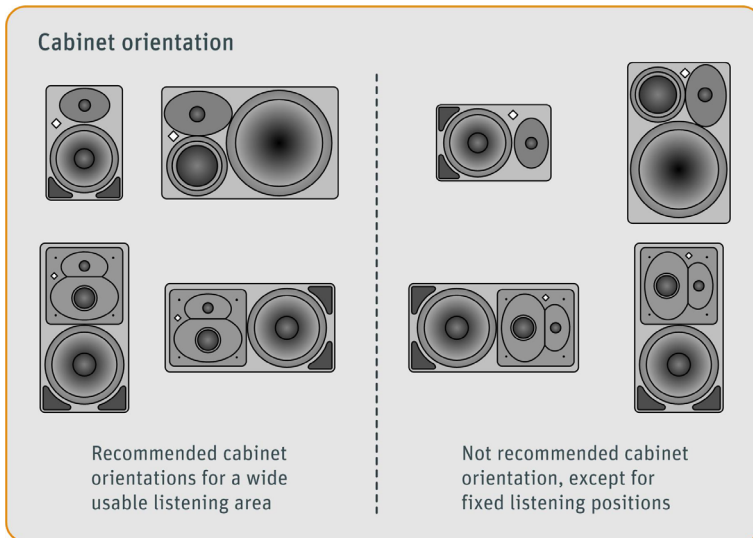

Symmetry brings better imaging

The following factors will improve stereo imaging:

- Using loudspeakers in a symmetrical room
- Locating the listening position symmetrically in the room
- Positioning the loudspeakers symmetrically in the room

The back wall should be located as far away as possible from the listening position. This leads to the general guideline that is better to point the loudspeakers down the room than across it.

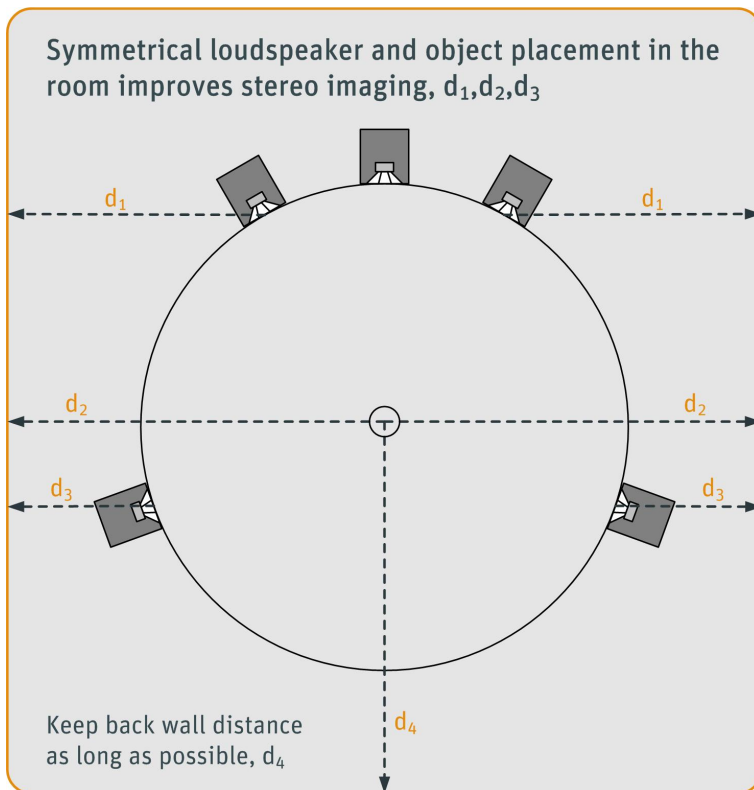



Placing the loudspeakers at the correct angle

Using the acoustical axis and listening position as references:

For two-channel stereo put the loudspeakers at $\pm 30^\circ$.

For 5.1 systems put the loudspeakers at 0° , $\pm 30^\circ$, and $\pm 110^\circ$.

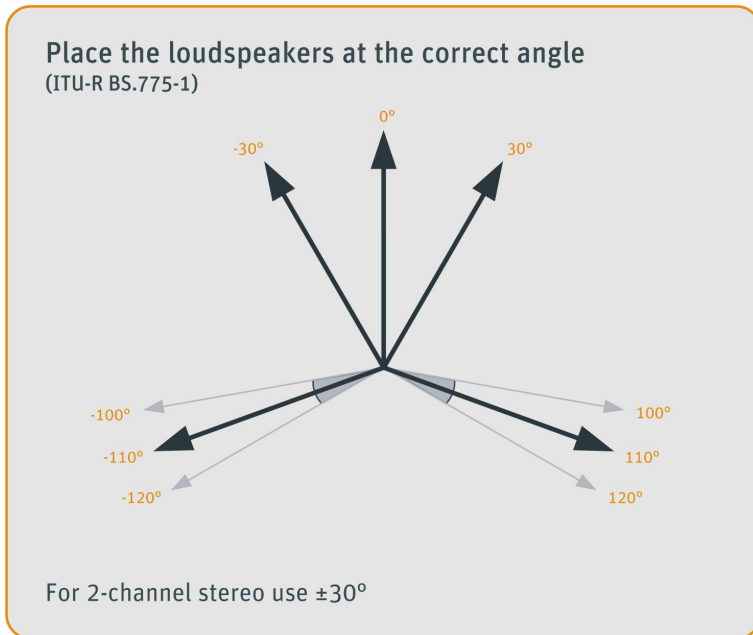



For 7.1 systems put the loudspeakers at 0° , $\pm 30^\circ$, $\pm 90^\circ$, and $\pm 150^\circ$.

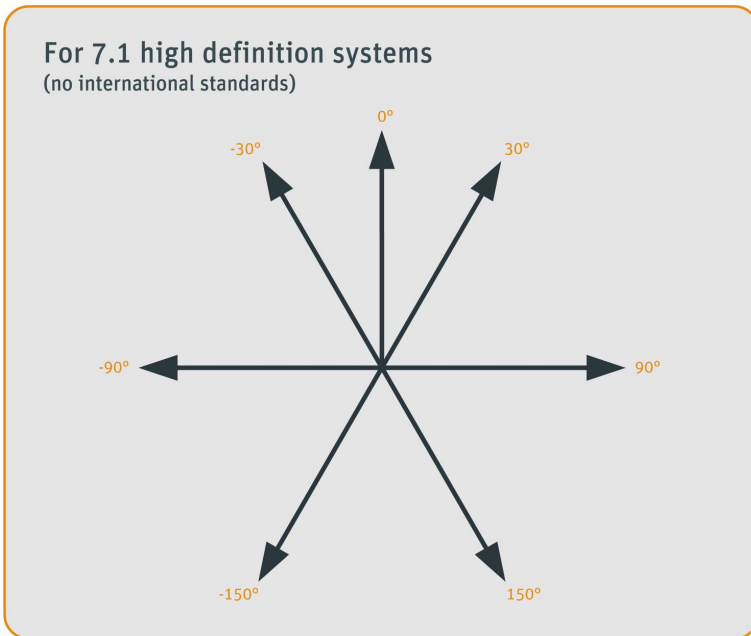

For larger systems, such as Auro 3D, NHK Super High Vision and Dolby Atmos, follow the guidelines associated with those systems.



Placing the loudspeakers at the same distance

Using the acoustical axis and listening position as references:

Smaller loudspeakers are generally used at shorter listening distances (1 – 2 m).

Larger loudspeakers are generally used at longer listening distances (2 – 4 m).

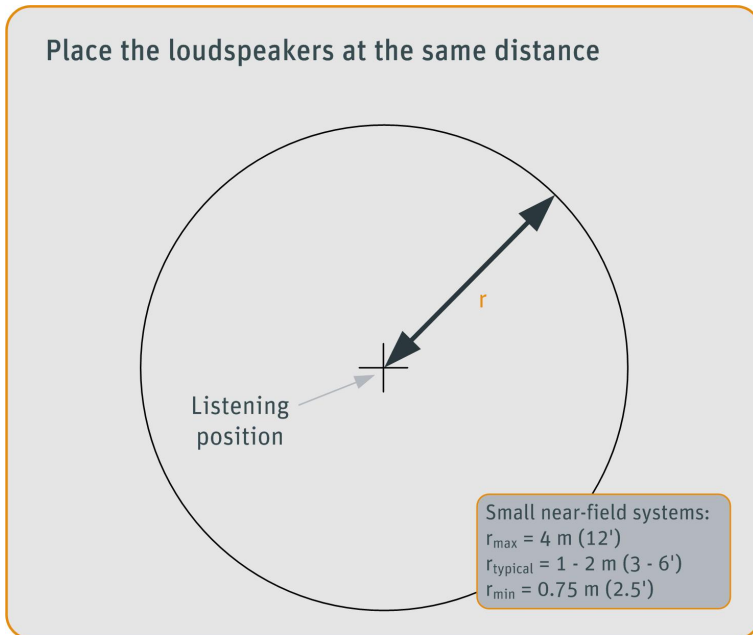

Delaying closer loudspeakers

Using the acoustical axis and listening position as references:

Loudspeakers positioned closer than the furthest loudspeaker from the listening position should be delayed by $30 \mu\text{s}/\text{cm}$ ($76 \mu\text{s}/\text{inch}$). The delay can be implemented in the following places if the system **IS NOT** bass managed:

- in the source equipment
- as a separate delay unit inserted between the source and the loudspeaker
- in the loudspeaker if there is a delay function included

If the system **IS** bass managed

- as a separate delay unit inserted between the subwoofer and the loudspeaker
- in the loudspeaker if there is an included delay function

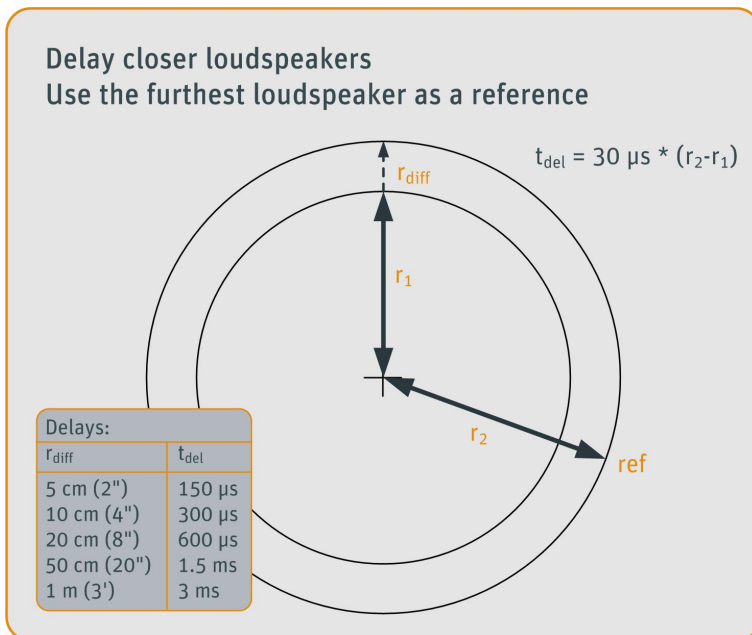

Achieving a flatter treble

Pointing the loudspeaker's acoustical axis at the listening position will improve the treble response (>1000 Hz).

Horizontal plane: Point the loudspeakers at listening position

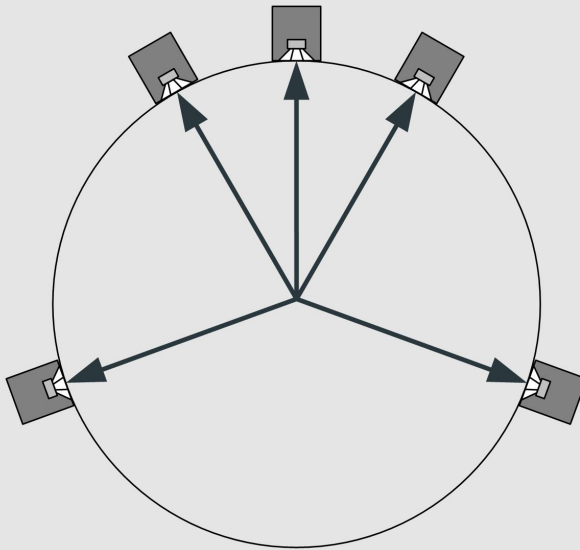

Use the acoustical axis as a reference



Achieving a smoother bass

The following will improve the bass response (<300 Hz) at the listening position:

- Using loudspeakers in a symmetrical room
- Locating the listening position symmetrically in the room
- Positioning the loudspeakers symmetrically in the room
- Avoid certain locations as shown in the picture below

Distance from the wall

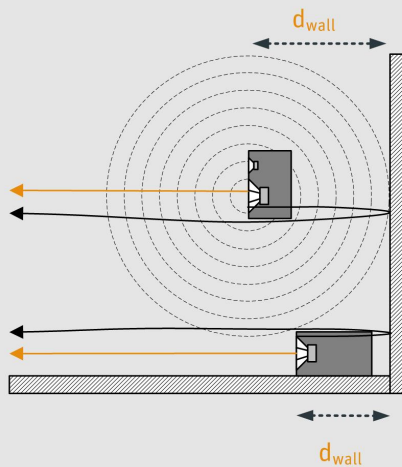

Full Range Loudspeakers

Avoid $d_{\text{wall}} = 0.8 - 2.0$ m

Bass Managed Loudspeakers

Avoid $d_{\text{wall}} = 0.8 - 1.0$ m

Subwoofers

Avoid $d_{\text{wall}} = >0.8$ m

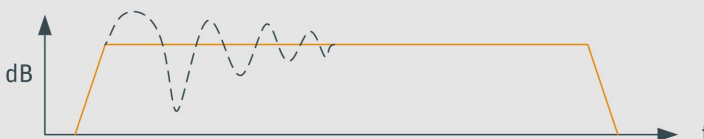



Achieving a smoother midrange

The following will improve the midrange response (500 – 5000 Hz) at the listening position:

- Symmetry of installation
- No nearby large reflecting objects and surfaces
- No objects between the loudspeaker and listening position
- Careful positioning of equipment to avoid reflections getting to the ears

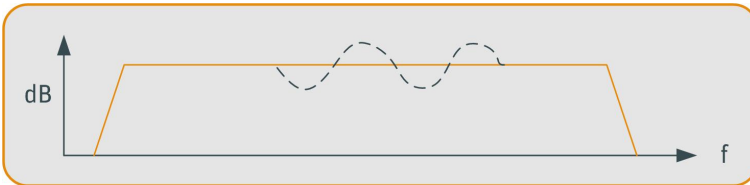
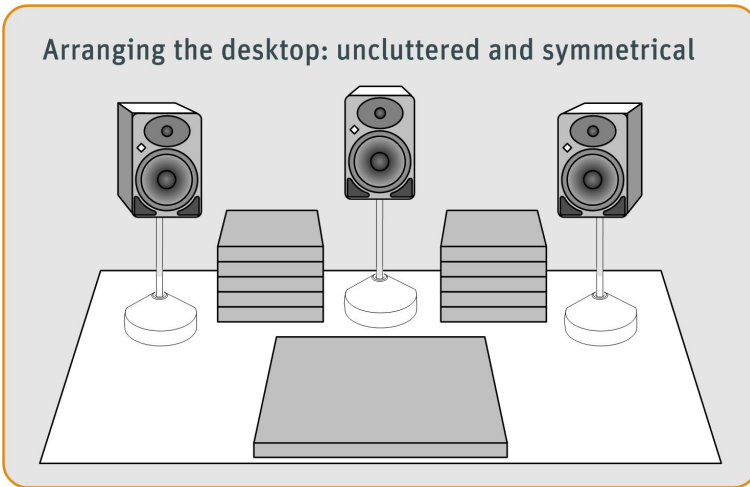



Careful positioning and angling can avoid nearby strong reflections from the ceiling and desktop. Avoid placing objects between the loudspeaker and the listening position.

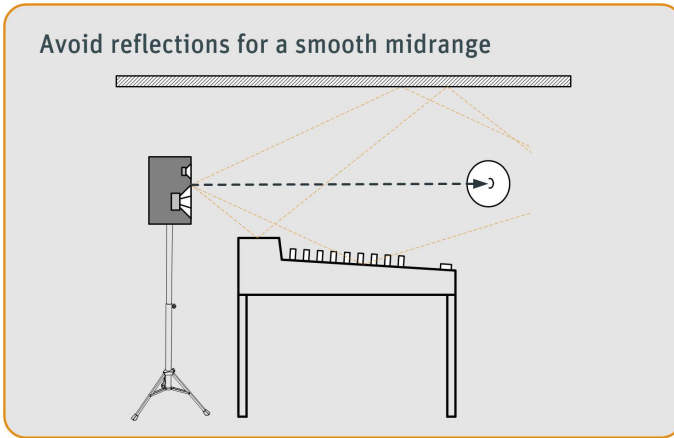

Avoid vertical angles greater than 15-20°. Sometimes turning the loudspeaker upside-down can help to reduce the vertical angle.

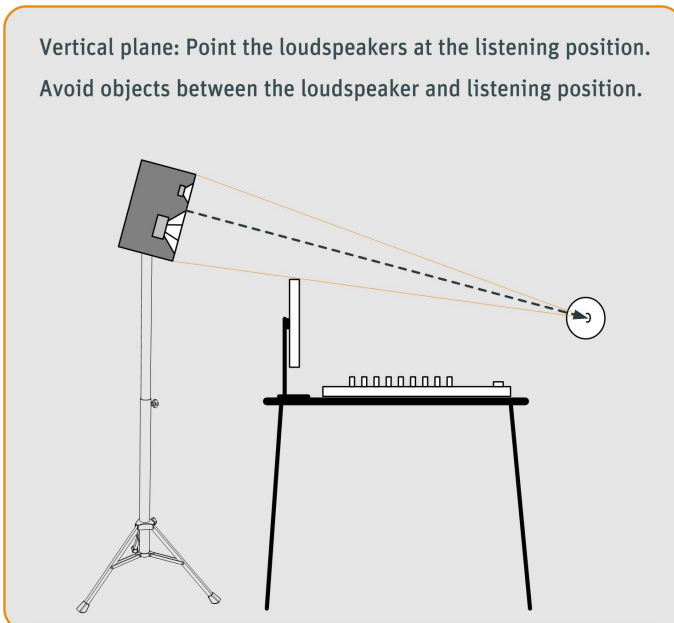



Flattening the in-room response

The environment influences the sound we hear at the listening position. Adjust the response of the loudspeaker to compensate for acoustical loading from nearby boundaries (walls, desks, etc.)

Acoustical controls

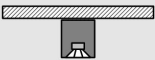
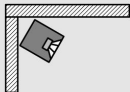
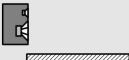
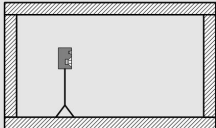
Against a wall		Solid: Bass = -5 dB Soft: Bass = -2.5 dB
In a corner		Bass = -7.5 dB Low-Mid = -1.5 dB
Near a desktop		Small: Low-Mid = -1.5 dB Large: Low-Mid = -3 dB
Free standing		Live: Treble = -1 dB Bass = -2.5 dB Dead: All 0 dB

A properly set up acoustical measurement system will help when selecting the correct combination of acoustical controls.

Flush mounting larger cabinets

The benefits of flush mounting are:

- Acoustical loading is increased (which should be compensated using the “bass” control) resulting in reduced low-frequency distortion.
- There is no cancellation from the wall behind the loudspeaker resulting in a flatter low-frequency response.
- There is no edge diffraction (assuming a smooth front panel-to-wall construction) resulting in a smoother midrange.

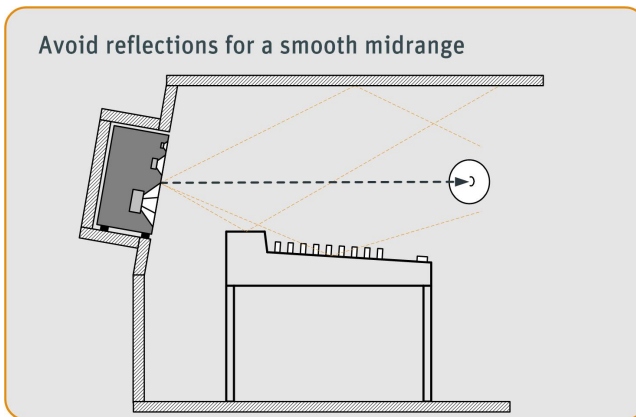

Subwoofers can also be flush mounted to save space in the listening room.

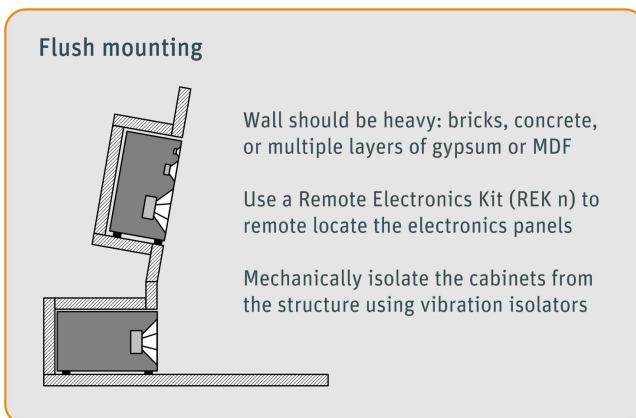



Adding subwoofers

Adding a subwoofer to a system brings some advantages:

- Lower LF cut-off
- Smaller main loudspeaker size for a given system maximum SPL
- Increased replay SPL, especially when playing bass heavy material, or when using a sealed cabinet design as main loudspeakers, or when using small main loudspeakers
- Decreased distortion for a given replay SPL
- Decreased group delay at frequencies previously reproduced by the main loudspeakers

and some disadvantages:

- Increased group delay around the subwoofer / main loudspeaker crossover frequency
- If the subwoofers are all located in one place or only one subwoofer is used, previously spatial distributed bass is reproduced from a single source location – classical music engineers particularly do not favor this

The advantages of multi-subwoofer systems compared to single-subwoofer systems are:

- Increased low-frequency output capacity compared to one subwoofer:
 - 2 subs → +6.0 dB SPL
 - 3 subs → +9.5 dB SPL
 - 4 subs → +12.0 dB SPL
- Decreased low-frequency distortion
- Allows for Plane Wave Bass Array™ techniques (PWBA™) to reduce side-to-side variance – see picture below
- Multiple smaller units, which might fit better into the available space, can be used instead of single larger units

The disadvantages of multi-subwoofer systems are:

- More (different) space required
- Can be harder to set-up
- Increase budget required



Positioning subwoofers

Subwoofers and rooms interact strongly so the ideal solution varies from room to room.

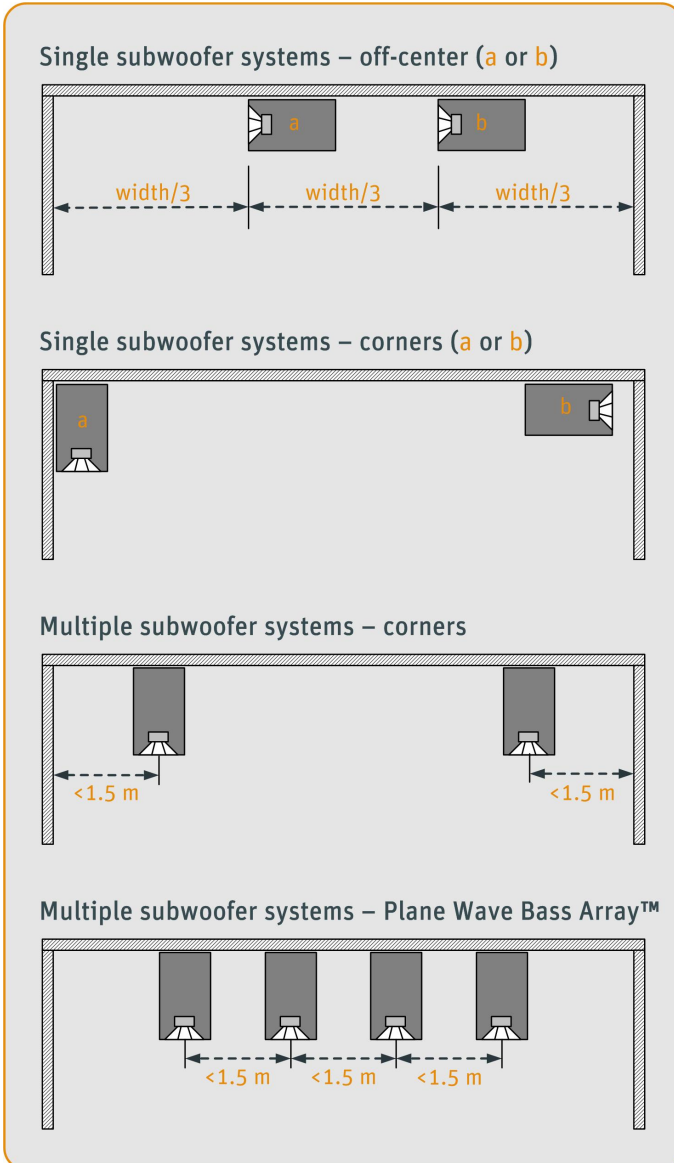



Calibrating subwoofers

The subwoofer's response is strongly influenced by the room. Adjust the response of the subwoofer to compensate for acoustical loading from nearby boundaries (walls) and lower the level when using multiple subwoofers (mutual coupling).

Acoustical controls

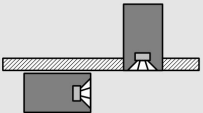
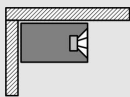
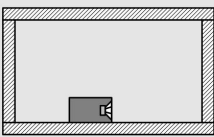
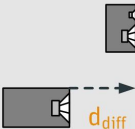
Against a wall or flush mounted		Solid: Level = -4 dB Low Cut = -2 dB Soft: Level = -2 dB Low Cut = 0 dB
In a corner		Level = -8 dB Low Cut = -4 dB
Free standing (not recommended)		Live: Level = -2 dB Low Cut = 0 dB Dead: All 0 dB
Different distances		Phase = see operating manual for details

If the subwoofer and loudspeakers are different distances from the listening position, the phase should be adjusted to compensate for the time-of-flight differences. 45° steps give a resolution of approx 50 cm (1½ ft). Incorrect adjustment of the phase control can result in a dip in the response around the crossover frequency (60 – 100 Hz). A properly set up acoustical measurement system will help when selecting the correct combination of acoustical controls.



What cables are required?

Interconnections should be made using good quality signal (microphone) cable with the following properties: shielded, balanced, low capacitance, non-microphonic. Robust connectors should also be used.

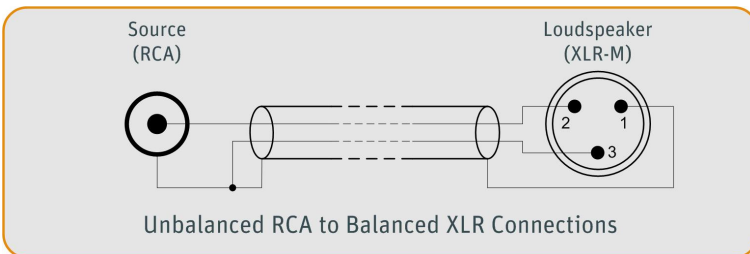
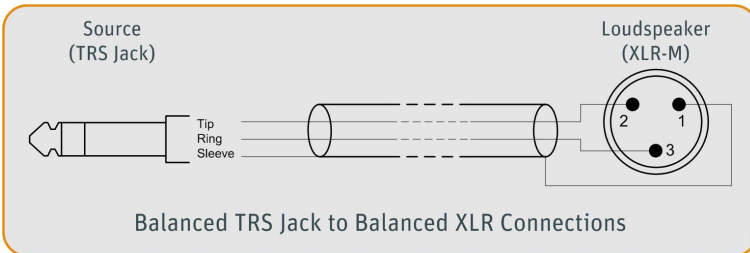
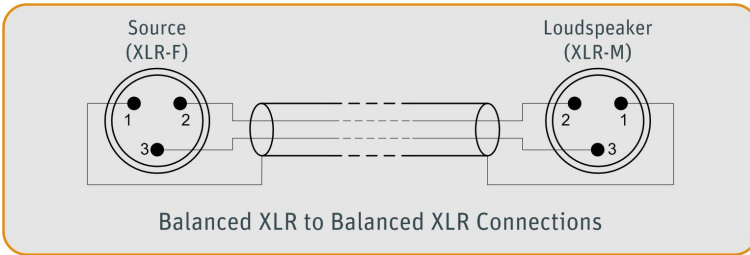

If there is a humming or buzzing sound from the loudspeakers that disappears when the ground lift switch is used, it usually means there is a wiring problem.



Wiring the system

To receive all the benefits of bass management, the system should be hooked-up correctly.

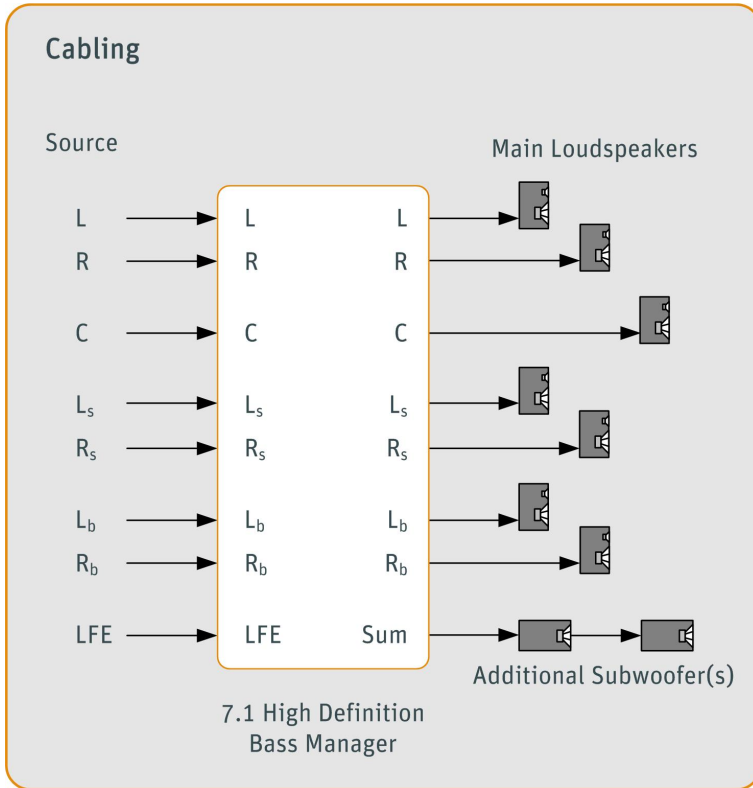

Bass management

Bass management moves the low-frequency portion of a signal to a loudspeaker other than the one normally used to reproduce that channel. For example the bass of the center channel is reproduced by a subwoofer. This reduces the work that the center loudspeaker is required to do thereby allowing a smaller loudspeaker to be used, or for the same sized loudspeaker to play with reduced distortion or at a higher level.

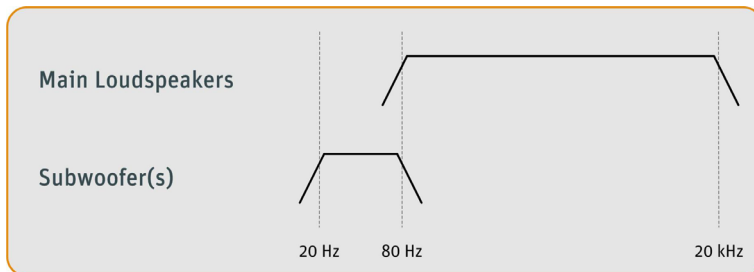

Advantages: Good balance of all acoustical factors. Main channels reproduced by the main loudspeakers and the subwoofer(s) down to the low-frequency cut-off of the subwoofer. Reduces the work done by the main loudspeakers thereby reducing the system's distortion and/or allowing the main loudspeakers to play louder. Significantly easier to setup.

Disadvantages: Acoustic problems near the crossover frequency have to be addressed acoustically. Signal cabling has to pass through a central location for signal processing.

Additionally, the LFE-channel can be routed to subwoofers and/or loudspeakers that have the capacity to reproduce this high-level low-frequency signal. Finally, greater flexibility is available when positioning the source of the low-frequency energy in the room which can result in a better sound quality. If the LFE channel is played into the subwoofer and the LFE-channel has an upper cut-off with a frequency higher than the crossover frequency, some re-routing may be required:



Option 1: Play the LFE-channel into a wideband input on the subwoofer. No re-routing to other loudspeakers.

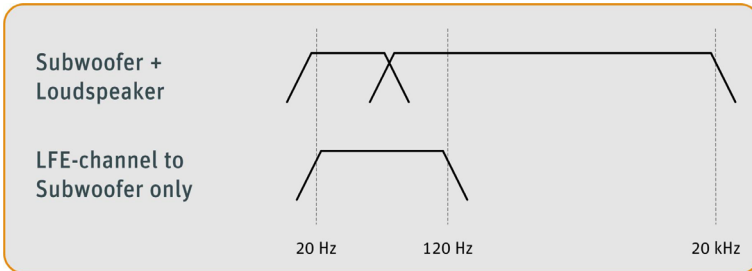

Option 2: The LFE channel is re-routed above the crossover to the left + right loudspeakers with a level change of -6 dB.

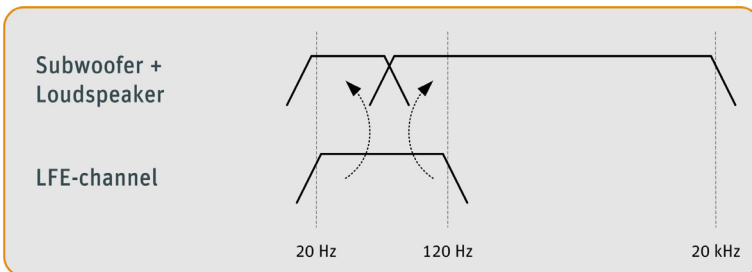

The LFE channel can be reproduced at the same level as the main channels (0 dB) or with a 10 dB boost (as required by Dolby and DTS).

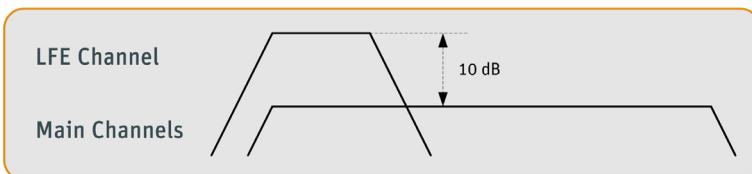



Technology descriptions

7.1 High Definition Bass Management™

7.1 Channel High Definition Bass Management™ is built into some models of the subwoofer range. It is compatible with all audio formats from mono through to the latest 7.1 High Definition systems. Eight analog inputs ensure flexible interconnectivity for modern studios. Four-mode LFE channel processing ensures maximum compatibility across all formats. 4th order crossovers and flexible acoustical controls allow for seamless system integration. Built-in volume control and other remotable functions allows for centralized system adjustment independent of the source.

Mathematically Modeled Dispersion™

The midrange (if present) and treble drivers are mounted into a Mathematically Modeled Dispersion™ waveguide (MMD™). It has been mathematically modeled and experimentally verified in an anechoic chamber to give optimum control of the directivity of the midrange and treble drivers. The benefits are increased driver loading, reduced edge diffraction and room reflections, a smoother power response, and a wide useable listening area. The result is a reduced audio distortion and a corresponding sound quality improvement. The MMD™ has 80 – 90° x 60° dispersion and, in the case of large models, can be rotated if the loudspeaker is to be mounted horizontally.

Plane Wave Bass Array™

A benefit of multiple subwoofer systems is the possibility to reduce the side wall interaction thereby improving consistency in the side-to-side low-frequency reproduction. This is important in studio applications where the sound engineer needs to move left and right along the mixing console, or where there are multiple listening positions along a large format mixing console, for example in the movie industry. The subwoofers should be positioned along the front wall to generate a plane wave down the room. This is called a “Plane Wave Bass Array™” (PWBA™). The required number of subwoofers depends on the width of the room: wider rooms need more subwoofers. Two to four small subwoofers are recommended for small rooms and three to four large subwoofers for larger rooms. The subwoofers should be positioned along the front wall with a spacing of 70 cm (2.5').

