

ALLEN & HEATH



XONE:PB

PATCH BAY

USER GUIDE

Publication AP7952

REGISTRATION CARD

ALLEN&HEATH PRODUCT REGISTRATION

Thankyou for buying an Allen & Heath product. We hope that you're happy with it and that you enjoy many years of faithful service with it.

SERIAL NUMBER	
---------------	--

Please return this section of the card by mail and retain the other part for your records. You can also register online at www.allen-heath.com. Thanks for your help.

Your Name: _____

Company Name: _____

Address 1: _____

Address 2: _____

Town/City: _____ County/State: _____

Country: _____ Postcode/Zip: _____

Telephone: _____

Email: _____

Why did you choose this console? _____

Which other products did you you consider before choosing A&H? _____

Is there any thing you would like to improve on this mixer? _____

What audio magazines do you read? _____

If you were going to design a mixer for your work, what are the 6 most important features it should have (in order of importance)

1	2
3	4
5	6

We may use the information you provide to inform you of future product developments. We will not give or sell this data to third parties. Please indicate with an 'x' if you do not wish to receive any further communications from us.

DIMENSIONS

Patchbay

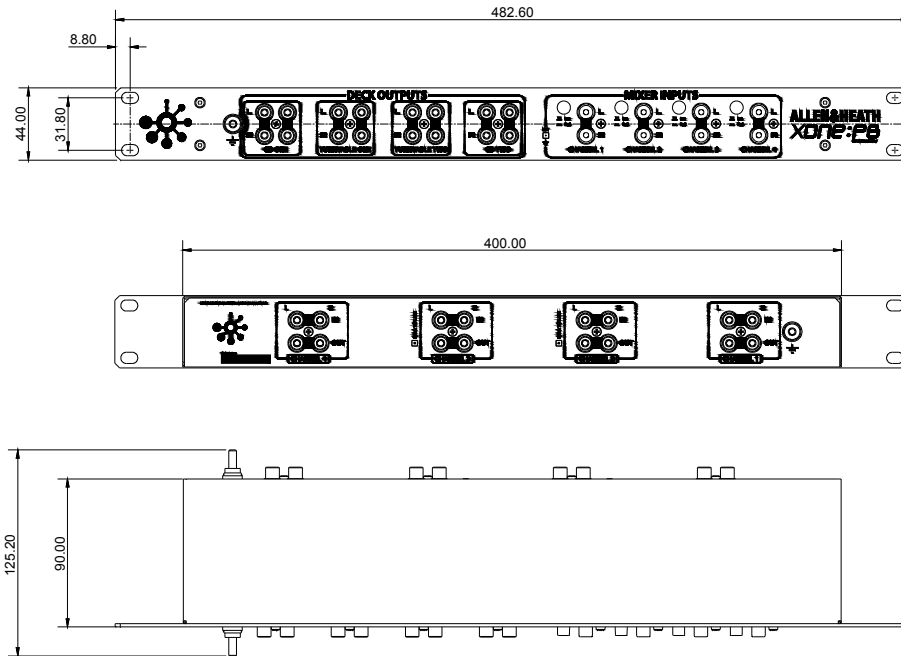

Packed Dimensions (mm) (inches)

Width	584	23.0
Height	120	7.7
Depth	194	4.8

Weight (Kg) (Lbs)

Patchbay	1.3	3.0
Packed	1.8	4.0

Limited One Year Warranty

This product is warranted to be free from defects in materials or workmanship for period of one year from the date of purchase by the original owner.

To ensure a high level of performance and reliability for which this equipment has been designed and manufactured, read this User Guide before operating. In the event of a failure, notify and return the defective unit to ALLEN & HEATH Limited or its authorised agent as soon as possible for repair under warranty subject to the following conditions

Conditions Of Warranty

The equipment has been installed and operated in accordance with the instructions in this User Guide.

The equipment has not been subject to misuse either intended or accidental, neglect, or alteration other than as described in the User Guide or Service Manual, or approved by ALLEN & HEATH.

Any necessary adjustment, alteration or repair has been carried out by ALLEN & HEATH or its authorised agent.

The defective unit is to be returned carriage prepaid to ALLEN & HEATH or its authorised agent with proof of purchase.

Units returned should be packed to avoid transit damage.

In certain territories the terms may vary. Check with your ALLEN & HEATH agent for any additional warranty which may apply.



This product complies with the European Electro magnetic Compatibility directive 2004/108/EC and the European Low Voltage Directive 2006/95/EC.

This product has been tested to EN55103 Parts 1 & 2 1996 for use in Environments E1, E2, E3, and E4 to demonstrate compliance with the protection requirements in the European EMC directive 89/336/EEC. During some tests the specified performance figures of the product were affected. This is considered permissible and the product has been passed as acceptable for its intended use. Allen & Heath has a strict policy of ensuring all products are tested to the latest safety and EMC standards. Customers requiring more information about EMC and safety issues can contact Allen & Heath NOTE: Any changes or modifications to the unit not approved by Allen & Heath could void its compliance and therefore the users authority to operate it.

CONTENTS

Congratulations on purchasing the Allen & Heath XONE:PATCHBAY. To ensure that you get the maximum benefit from the unit please spare a few minutes familiarizing yourself with the setup procedures outlined in this user guide. For further information please refer to the additional information available on our web site, or contact our technical support team.

<http://www.xone.co.uk>

<http://www.allen-heath.com>

Warranty.....	2
Rear Panel Connectors	4
Rear Panel Normalised Wiring	6
Rear Panel Wiring Diagram.....	7
Front Panel Connectors.....	9
Front Panel Wiring / Wiring Diagram	11
Multiple External Sources	12
Dimensions	13
Registration Card.....	14

XONE:PATCHBAY User Guide AP7952

Copyright © 2010 Allen & Heath Limited. All rights reserved

Allen & Heath Limited

Kernick Industrial Estate, Penryn, Cornwall, TR10 9LU, UK

MULTIPLE EXTERNAL SOURCES

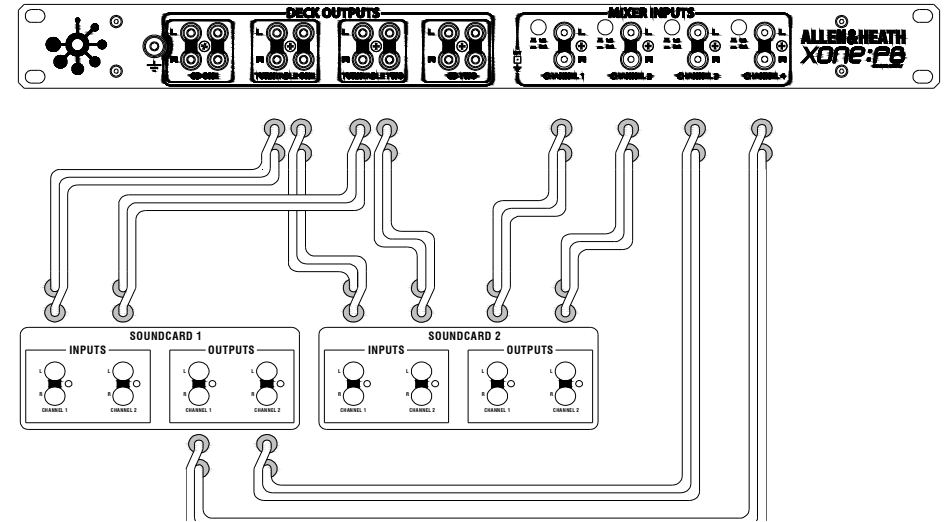

Wiring Multiple Soundcards

More than one soundcard may be wired to the patchbay at any one time. This feature is useful when preparing for DJ changeovers. An example is two DJ's both using encoded vinyl on the house turntables.

With reference to the above diagram, Soundcard 1 is taking its inputs from Deck Outputs 2 and 3 and its outputs are connected to Mixer Channels 3 and 4.

Soundcard 2 is taking its inputs from Deck Outputs 2 and 3 and its outputs are connected to Mixer Channels 1 and 2.

In this situation, both systems are receiving the same encoded vinyl signals, but have separate channels on the mixer, allowing for seamless mixing between the two sets.

NOTE: When using laptop-based mixing systems it is imperative that a solid earth is achieved in order to reject noise. Earth posts are provided on the front and back of the XONE:PATCHBAY, these must be connected to all external equipment.

FRONT PANEL WIRING

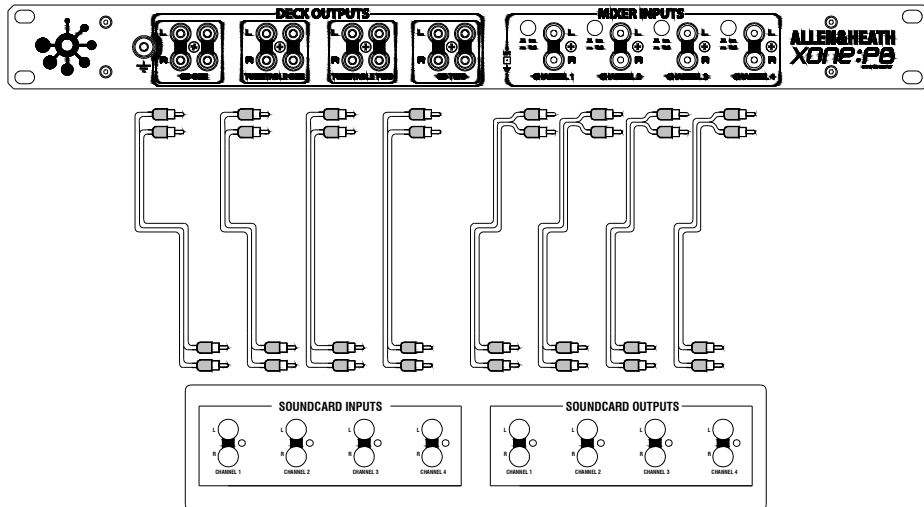

Wiring The Front Panel

The front panel is split into two sections; DECK OUTPUTS and MIXER INPUTS.

Deck Outputs

The Deck Outputs carry the signals from the connected CD players or turntables. Each output has two sets of connectors, allowing for more than one soundcard system to be connected simultaneously.

The Deck Outputs should be wired to the relevant Inputs on the soundcard to be attached.

Mixer Inputs

The Mixer Inputs connect the audio from the soundcard back to the mixer. The Mixer Input Source select switch should then be set in the following way:

INT for 'Normalised' mode where no external source is being used. In this mode, the audio from the connected players will route straight through to the mixer.

EXT for the case where a soundcard system is being used. In this mode, the audio from the soundcard outputs will be routed to the mixer.

REAR PANEL CONNECTORS

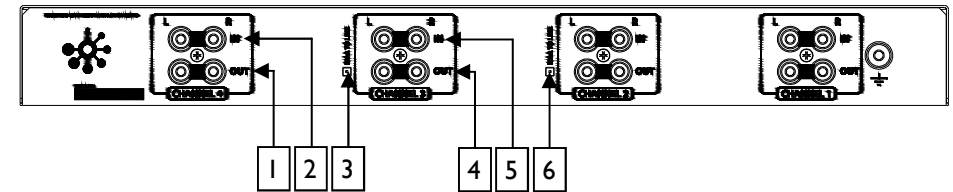

1 CHANNEL 4 OUTPUT

Connect to Channel 4 of the mixer, Line level only.

2 CHANNEL 4 INPUT

Connect output from CD here.

3 CHANNEL 3 RIAA TO LINE SELECTOR

Setting this switch will route the audio through a reverse RIAA filter allowing a Line level to enter a Phono level input. If turntables are connected to patchbay channels 2 and 3, this switch must be set.

4 CHANNEL 3 OUTPUT

Connect to Channel 3 of the mixer, Line or Phono level.

5 CHANNEL 3 INPUT

Connect output from CD or turntable here.

6 CHANNEL 2 RIAA TO LINE SELECTOR

Setting this switch will route the audio through a reverse RIAA filter allowing a Line level to enter a Phono level input. If turntables are connected to patchbay channels 2 and 3, this switch must be set.

REAR PANEL CONNECTORS

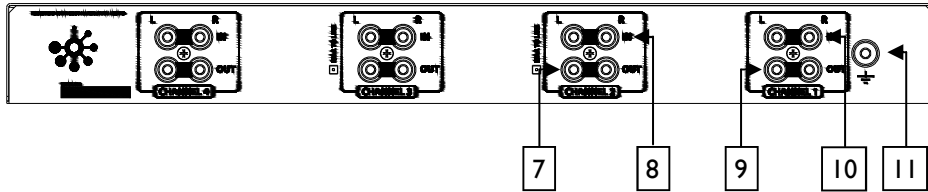

7 CHANNEL 2 OUTPUT

Connect to Channel 2 of the mixer, Line or Phono level.

8 CHANNEL 2 INPUT

Connect output from CD or turntable here.

9 CHANNEL 1 OUTPUT

Connect to Channel 1 of the mixer, Line level only.

10 CHANNEL 1 INPUT

Connect output from CD here.

11 CHASSIS EARTH TERMINAL

A screw terminal is provided for connecting the earth straps from turntables. This connection earths the metal parts of the turntable to reduce hum, buzz or similar audible noise getting into the system.

FRONT PANEL CONNECTORS

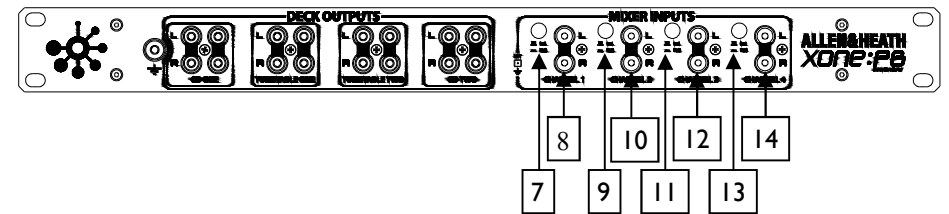

7 INPUT 1 SOURCE SELECT BUTTON

Selects between INT or EXT source to mixer input 1.

8 INPUT 1 CONNECTORS

Dual RCA connectors for connecting an external source to mixer input 1.

9 INPUT 2 SOURCE SELECT BUTTON

Selects between INT or EXT source to mixer input 2.

10 INPUT 2 CONNECTORS

Dual RCA connectors for connecting an external source to mixer input 2.

11 INPUT 3 SOURCE SELECT BUTTON

Selects between INT or EXT source to mixer input 3.

12 INPUT 3 CONNECTORS

Dual RCA connectors for connecting an external source to mixer input 3.

13 INPUT 4 SOURCE SELECT BUTTON

Selects between INT or EXT source to mixer input 4.

14 INPUT 4 CONNECTORS

Dual RCA connectors for connecting an external source to mixer input 4.

FRONT PANEL CONNECTORS

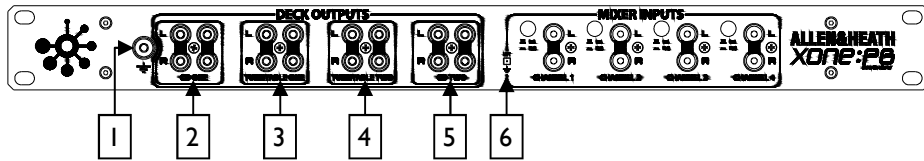

1 CHASSIS EARTH TERMINAL

A screw terminal is provided for connecting the earth straps from turntables. This connection earths the metal parts of the turntable to reduce hum, buzz or similar audible noise getting into the system.

2 CD ONE OUTPUT

Two dual RCA connectors for routing of the CD One audio.

3 TURNTABLE ONE OUTPUT

Two dual RCA connectors for routing of the Turntable One audio.

4 TURNTABLE TWO OUTPUT

Two dual RCA connectors for routing of the Turntable Two audio.

5 CD TWO OUTPUT

Two dual RCA connectors for routing of the CD Two audio.

6 GROUND LIFT

Recessed switch allowing for ground isolation of the Mixer Input RCA connectors. Ground Lift should be applied in the event of an earth loop condition.

REAR PANEL NORMALISED WIRING

Normalised Wiring

When a system is wired for standard operation through a patchbay it is referred to as Normalising. In the case of the XONE:PATCHBAY, the rear panel connections are used to normalise the system wiring. CD's or Turntables are wired to the IN sockets and the OUT sockets are wired to the mixer. For normal operation, the MIXER INPUT switches on the front panel must be set to INT (see page 11).

Wiring The Rear Panel

All of the following instructions refer to the Rear Panel Wiring Diagram on pages 7 and 8.

The rear panel of the XONE:PATCHBAY is laid out such that the IN and OUT connections per 'Channel' are grouped together.

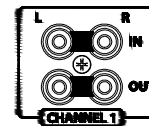

The IN connection is connected to either a CD or Turntable.

The OUT connection is wired to the relevant channel on a mixer.

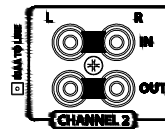

Channels 1 and 4 are LINE only, Channels 2 and 3 can be used for PHONO or LINE level inputs. Channels 2 and 3 feature an 'RIAA TO LINE' switch which must be SET (pushed in) if turntables are being used.

RIAA TO LINE

The RIAA TO LINE switch allows for a LINE level return from an external device to be fed into a PHONO input on the connected mixer. This means that when an encoded vinyl system is used, the soundcard system output can be 'seen' on the PHONO input of the mixer without distorting.

REAR PANEL WIRING DIAGRAM

