

PWB-250 SERIES DIMENSIONS

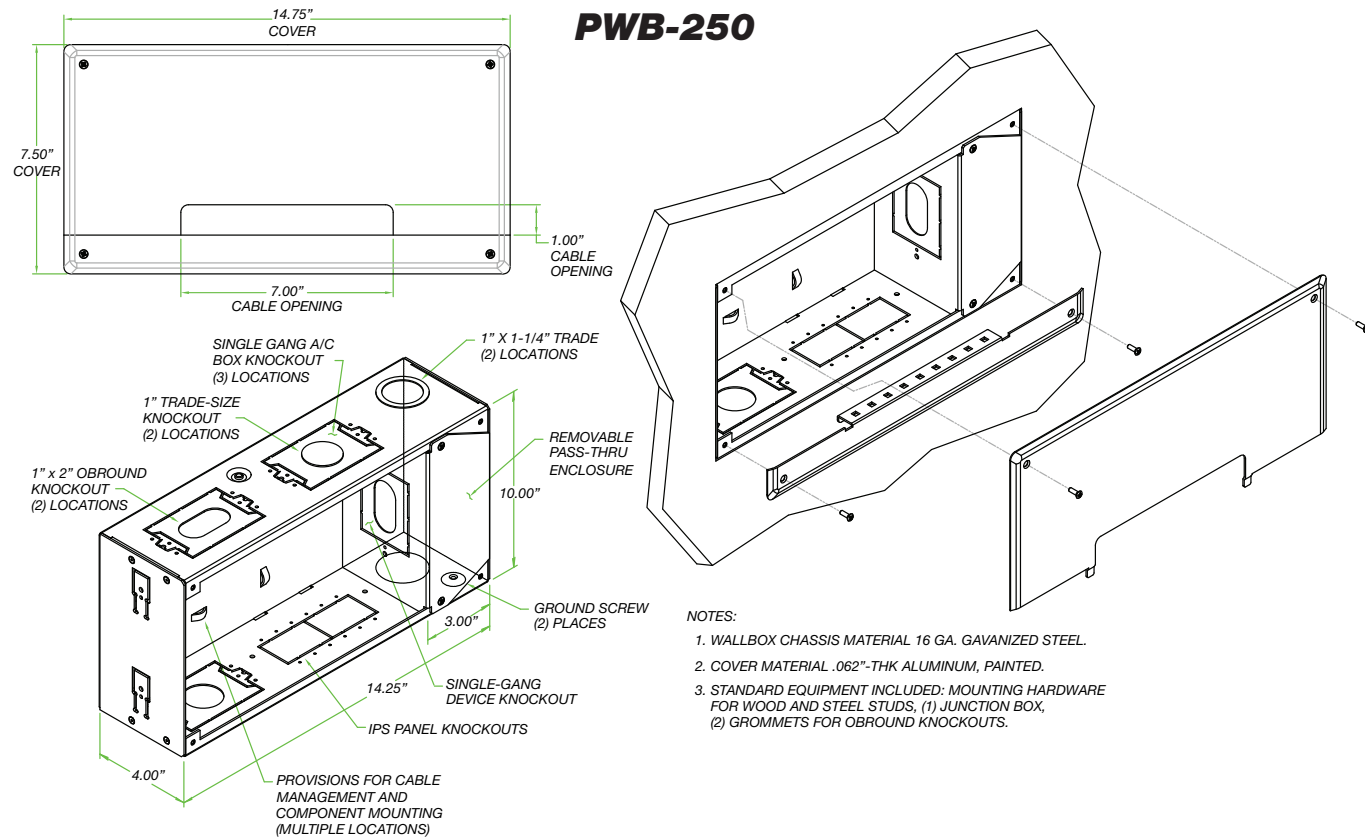

PWB-253

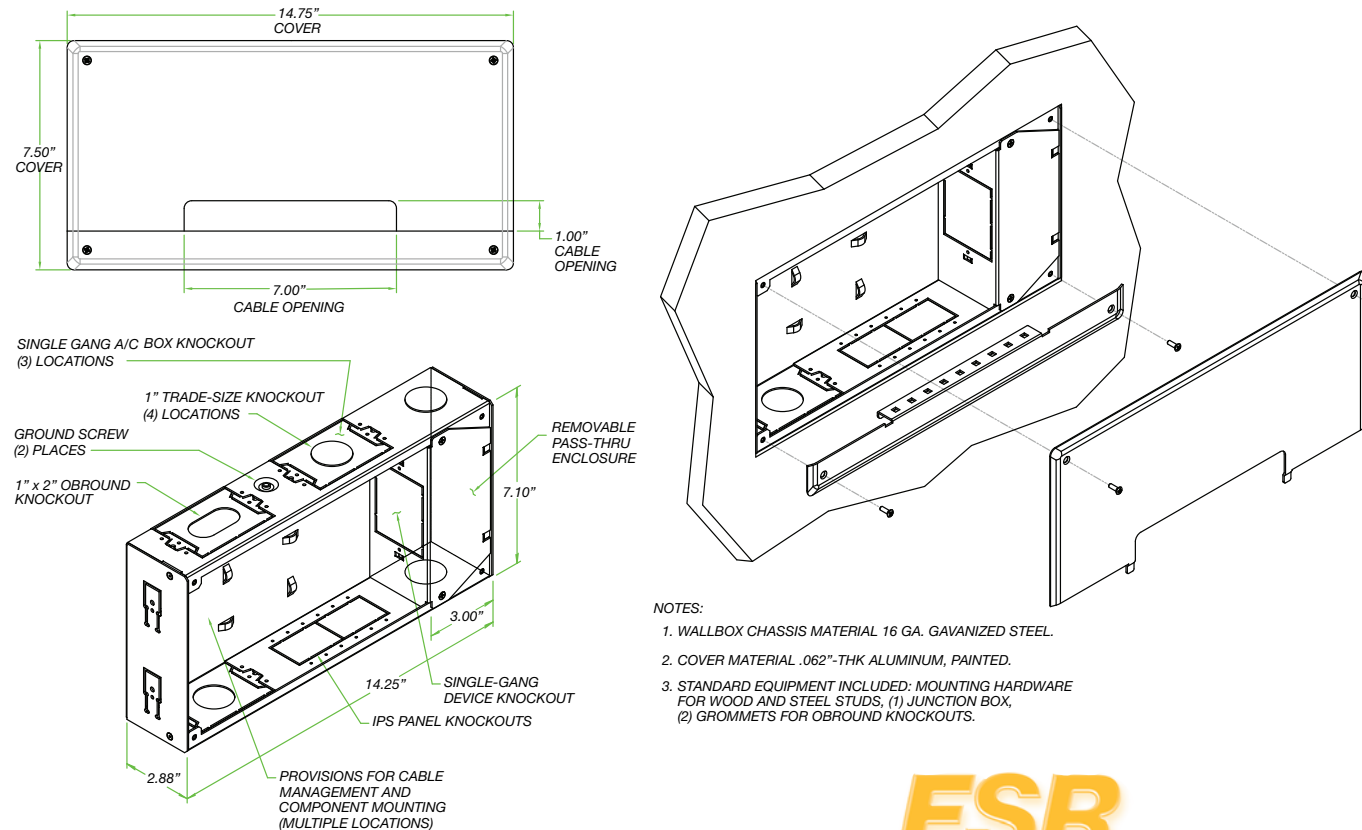

244 Bergen Boulevard, Woodland Park, NJ 07424
Phone: 973.785.4347 · Fax: 973.785.4207
Web: www.fsrinc.com · E-mail: sales@fsrinc.com

Specifications are subject to change without notice.



PWB-200 Series Plasma/Flat Panel Display Wall Box

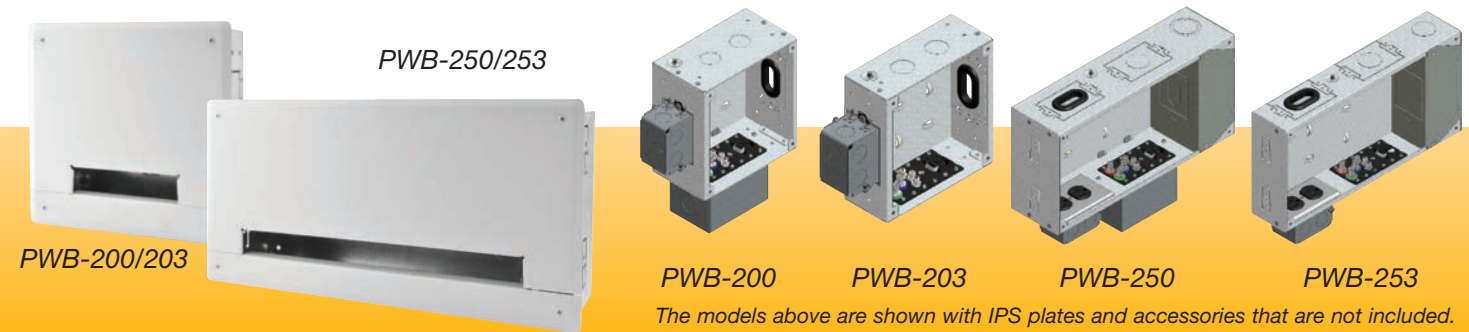

DESCRIPTION

The PWB-200 series balance quality and cost, bringing fully featured wall boxes to you at an affordable price. We have kept the cost low while delivering the quality and ease of installation you have always experienced with FSR products.

All models are ready to install and include a two part cover with mounting screws in either black or white, back box, screws for wood or steel stud mounting, grounding screws, tie wraps, and a rubber grommet. One of the single gang knockouts has a 1"x2" oblong internal knockout and can be used with the supplied grommet.

There are four models designed to fit the individual application requirements:

The **PWB-200** is approximately 7"x7"x4" with two single gang knockouts, and one IPS knockout to mount up to six single IPS plates. The unit is designed to fit 2"x4" stud walls.

The largest and highest capacity model is the **PWB-250**. This unit is approximately 14.25"x7"x4" and has three single gang knockouts and one IPS knockout to mount up to six single IPS plates. In addition, a removable passthrough enclosure provides an additional single gang knockout and can be used to isolate cables that the installer may need to pass through the backbox.

Specifically sized for installation in 2"x3" stud walls, the PWB-203 and PWB-253 are 3" deep versions of the PWB-200 and PWB-250 respectively. One steel duplex cover plate (PWB-203/253) and one steel Decora cover plate (PWB-253 only) is included for convenience and to ensure proper fit in the shallow back box.

ACCESSORIES

The PWB-2X0-AVBB is an optional AV back box to enclose the exterior of the IPS knockout area (PWB-200 and PWB-250 only).

The PWB-20X-MNT is a set of bracket ears that allow the installer to position the PWB-200 or PWB-203 at different locations between the studs while mounting.

The PWB-xxx-SLD abandonment covers, are available in black or white. They are used in place of the finish covers to protect the units during construction or when they are used as closed utility boxes not requiring external cable access.

FEATURES

- Rugged 16 gauge steel back box with 1/16" front cover
- Compatible with FSR's IPS inserts
- Can be installed in new or old work (mounting adapters included)
- AC back box included
- Connectors are hidden behind an attractive cover
- Multiple knockouts in a variety of sizes
- UL listed AC back box provided

APPLICATIONS

- Anywhere a video display is wall mounted!
- Digital Signage
- Conference Centers
- Schools
- Airports
- Electronic Billboards
- Museums
- General Meeting Facilities
- Arenas

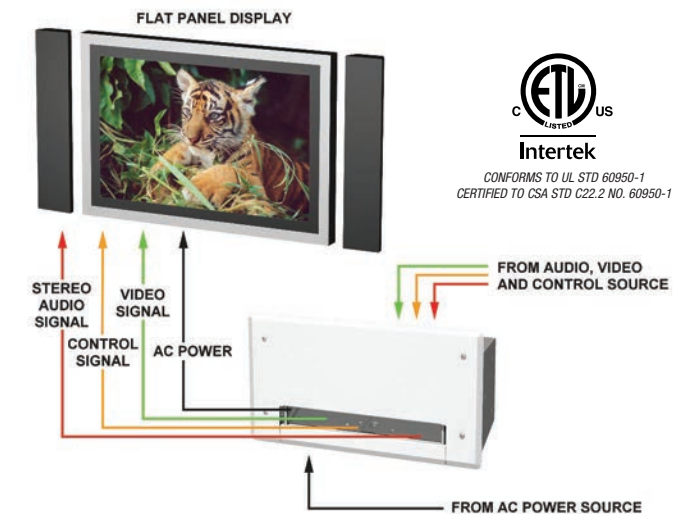

FSR Inc.

244 Bergen Boulevard, Woodland Park, NJ 07424
Phone: 973.785.4347 · Fax: 973.785.4207
Web: www.fsrinc.com · E-mail: sales@fsrinc.com
Order Desk: 1-800-332-FSR1 LIT1352A

PWB-200 ACCESSORIES

IPS Audio / Video Inserts



IPS Audio Inserts

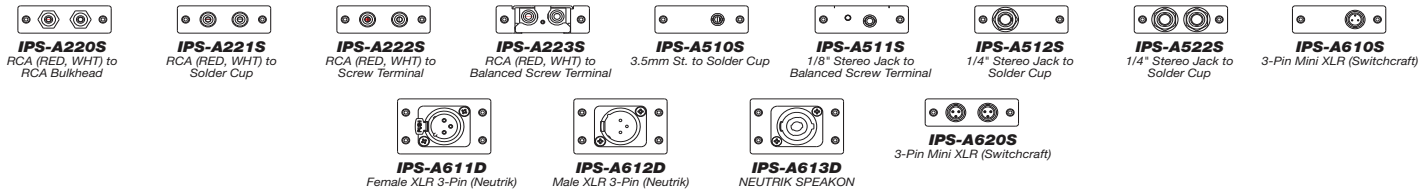

IPS Video Inserts

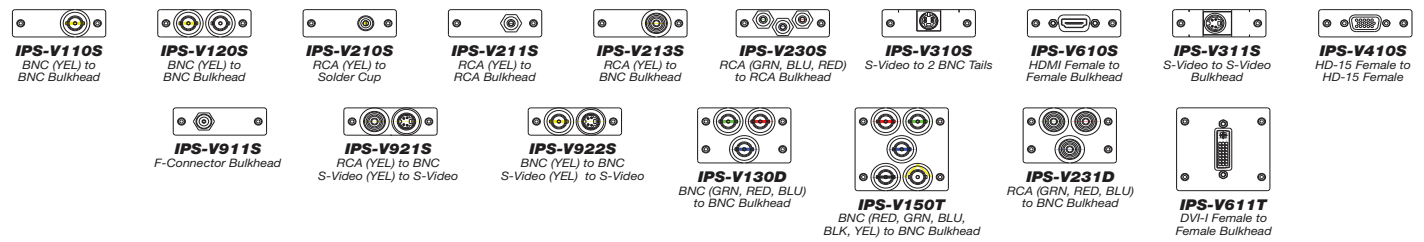

IPS Voice / Data Inserts

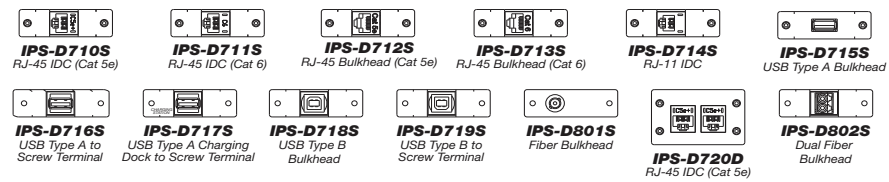

Simple Solutions Inserts (Decora)

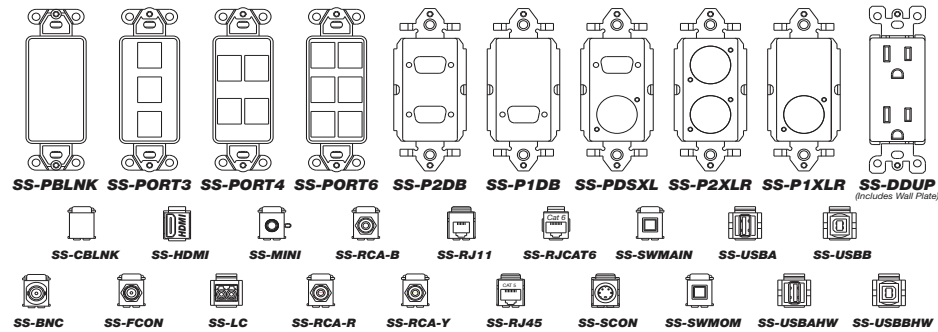

AV Interfaces

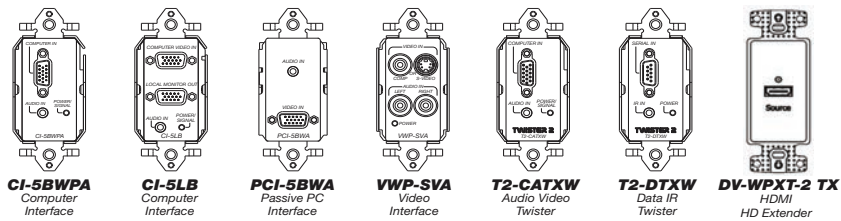

IPS Blank Inserts

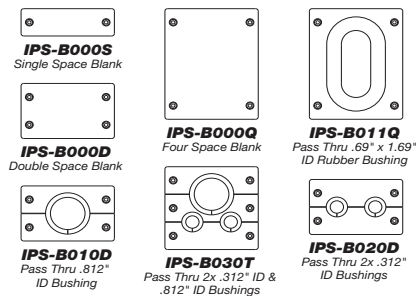

IPS Control Inserts

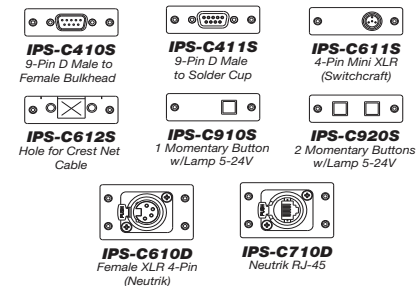

IPS AC Insert

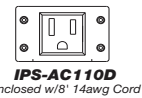

Most items above are available in white, ivory or black to match the decor. We are always adding to our IPS and SS line. Please visit our website or contact sales for detailed information.

PWB-200 SERIES DIMENSIONS

PWB-200

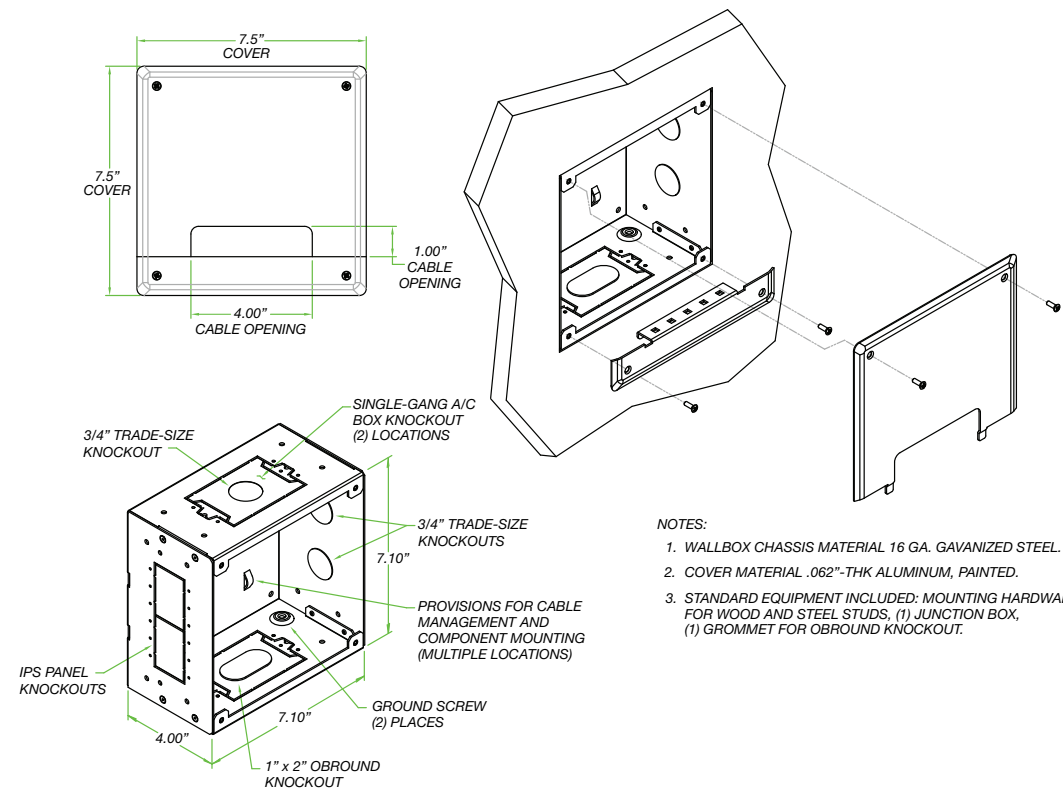

- NOTES:
1. WALLBOX CHASSIS MATERIAL 16 GA. GAVANIZED STEEL.
2. COVER MATERIAL .062"-THK ALUMINUM, PAINTED.
3. STANDARD EQUIPMENT INCLUDED: MOUNTING HARDWARE FOR WOOD AND STEEL STUDS, (1) JUNCTION BOX, (1) GROMMET FOR OBROUND KNOCKOUT.

PWB-203

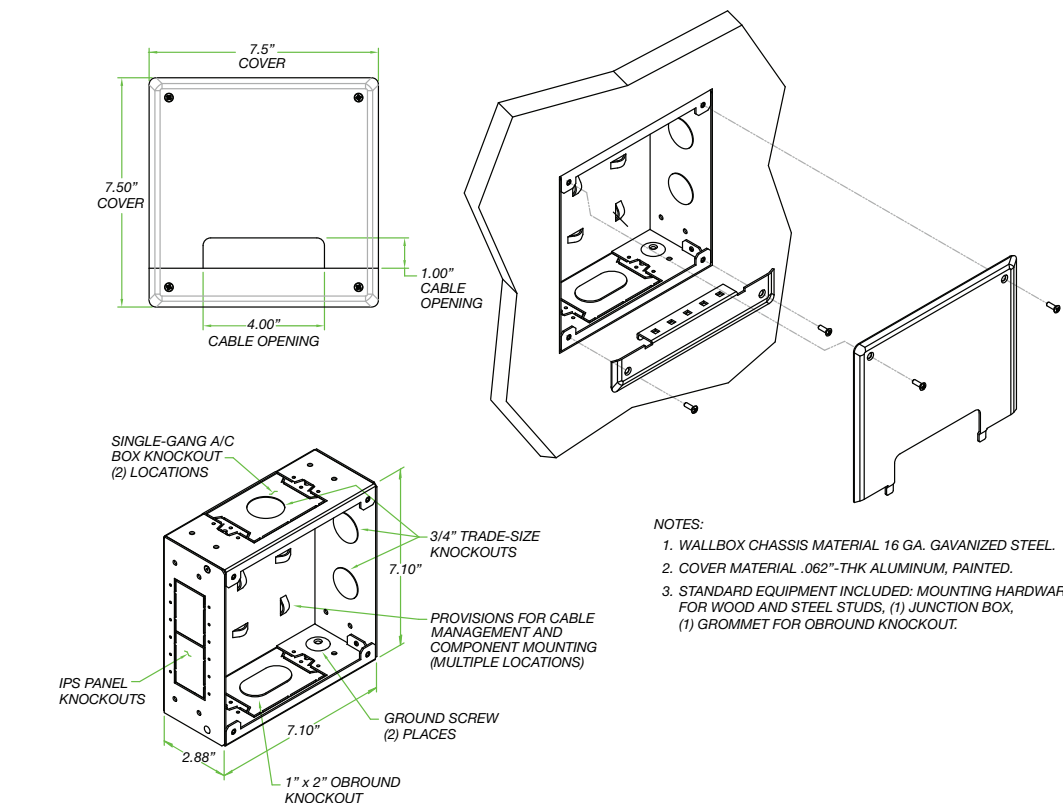

- NOTES:
1. WALLBOX CHASSIS MATERIAL 16 GA. GAVANIZED STEEL.
2. COVER MATERIAL .062"-THK ALUMINUM, PAINTED.
3. STANDARD EQUIPMENT INCLUDED: MOUNTING HARDWARE FOR WOOD AND STEEL STUDS, (1) JUNCTION BOX, (1) GROMMET FOR OBROUND KNOCKOUT.