

# ALLEN & HEATH



## Xone:22

### USER GUIDE

Publication AP7402

## **Limited One Year Warranty**

This product is warranted to be free from defects in materials or workmanship for period of one year from the date of purchase by the original owner.

To ensure a high level of performance and reliability for which this equipment has been designed and manufactured, read this User Guide before operating. In the event of a failure, notify and return the defective unit to ALLEN & HEATH Limited or its authorised agent as soon as possible for repair under warranty subject to the following conditions

### **Conditions Of Warranty**

The equipment has been installed and operated in accordance with the instructions in this User Guide.

The equipment has not been subject to misuse either intended or accidental, neglect, or alteration other than as described in the User Guide or Service Manual, or approved by ALLEN & HEATH.

Any necessary adjustment, alteration or repair has been carried out by ALLEN & HEATH or its authorised agent.

This warranty does not cover fader wear and tear.

The defective unit is to be returned carriage prepaid to ALLEN & HEATH or its authorised agent with proof of purchase.

Units returned should be packed to avoid transit damage.

In certain territories the terms may vary. Check with your ALLEN & HEATH agent for any additional warranty which may apply.

This product complies with the European Electro magnetic Compatibility directives 89/336/EEC & 92/31/EEC and the European Low Voltage Directives 73/23/EEC & 93/68/EEC.

This product has been tested to EN55103 Parts 1 & 2 1996 for use in Environments E1, E2, E3, and E4 to demonstrate compliance with the protection requirements in the European EMC directive 89/336/EEC. During some tests the specified performance figures of the product were affected. This is considered permissible and the product has been passed as acceptable for its intended use. Allen & Heath has a strict policy of ensuring all products are tested to the latest safety and EMC standards. Customers requiring more information about EMC and safety issues can contact Allen & Heath.

XONE:22 User Guide AP7402 Issue 1

Copyright © 2009 Allen & Heath Limited. All rights reserved

Allen & Heath Limited

Kernick Industrial Estate, Penryn, Cornwall, TR10 9LU, UK

<http://www.allen-heath.com> <http://www.xone.co.uk>

# PACKED ITEMS

Check that you have received the following:

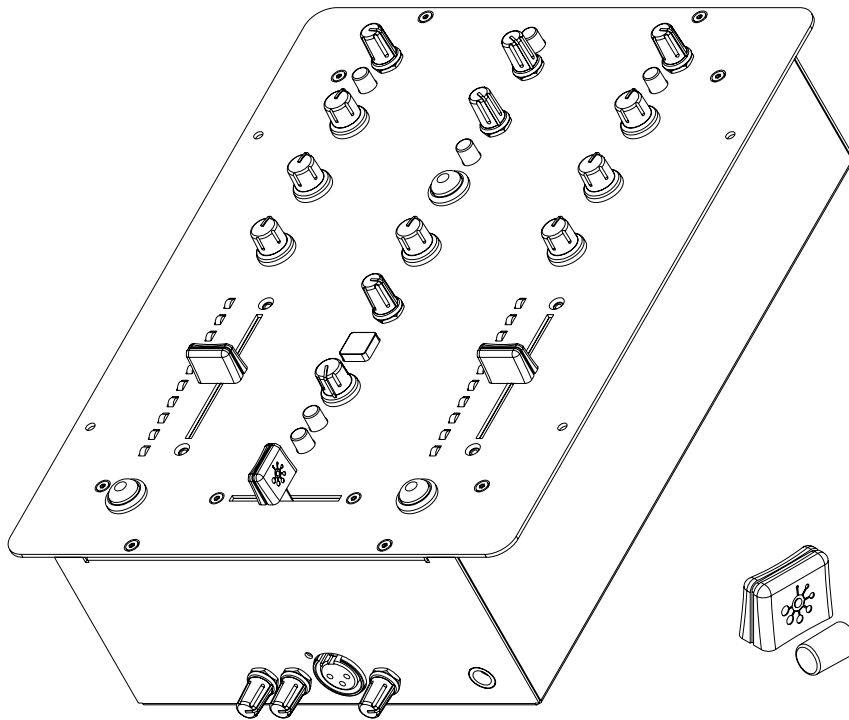

Xone:22 mixer

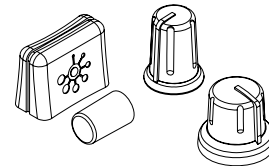

Spare knobs

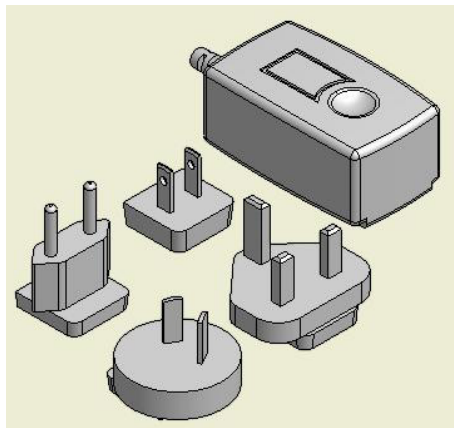

Power Supply

Fit the correct mains adaptor for your region.



Safety Sheet

**Important !** Read this sheet before starting.

Retain for future reference.

# CONTENTS

Congratulations on purchasing the Allen & Heath Xone:22 performance DJ mixer. To ensure that you get the maximum benefit from the unit please spare a few minutes familiarizing yourself with the controls and setup procedures outlined in this user guide. For further information please refer to the additional information available on our web site, or contact our technical support team.

<http://www.xone.co.uk>

<http://www.allen-heath.com>

Warranty.....	2
Packed Items .....	3
Contents .....	4
Connection diagram.....	5
Introduction .....	6
Input channel controls .....	7
Master section controls.....	8
Master section controls continued.....	9
Rear panel connections .....	10
Front panel connections.....	11
Filters reference .....	12
Operating levels .....	13
Earthing .....	14
Servicing and jumper settings.....	15
User replaceable spare parts.....	16
Fault finding .....	17
Specification.....	18
Block Diagram .....	19
Product registration .....	21

# CONNECTION DIAGRAM

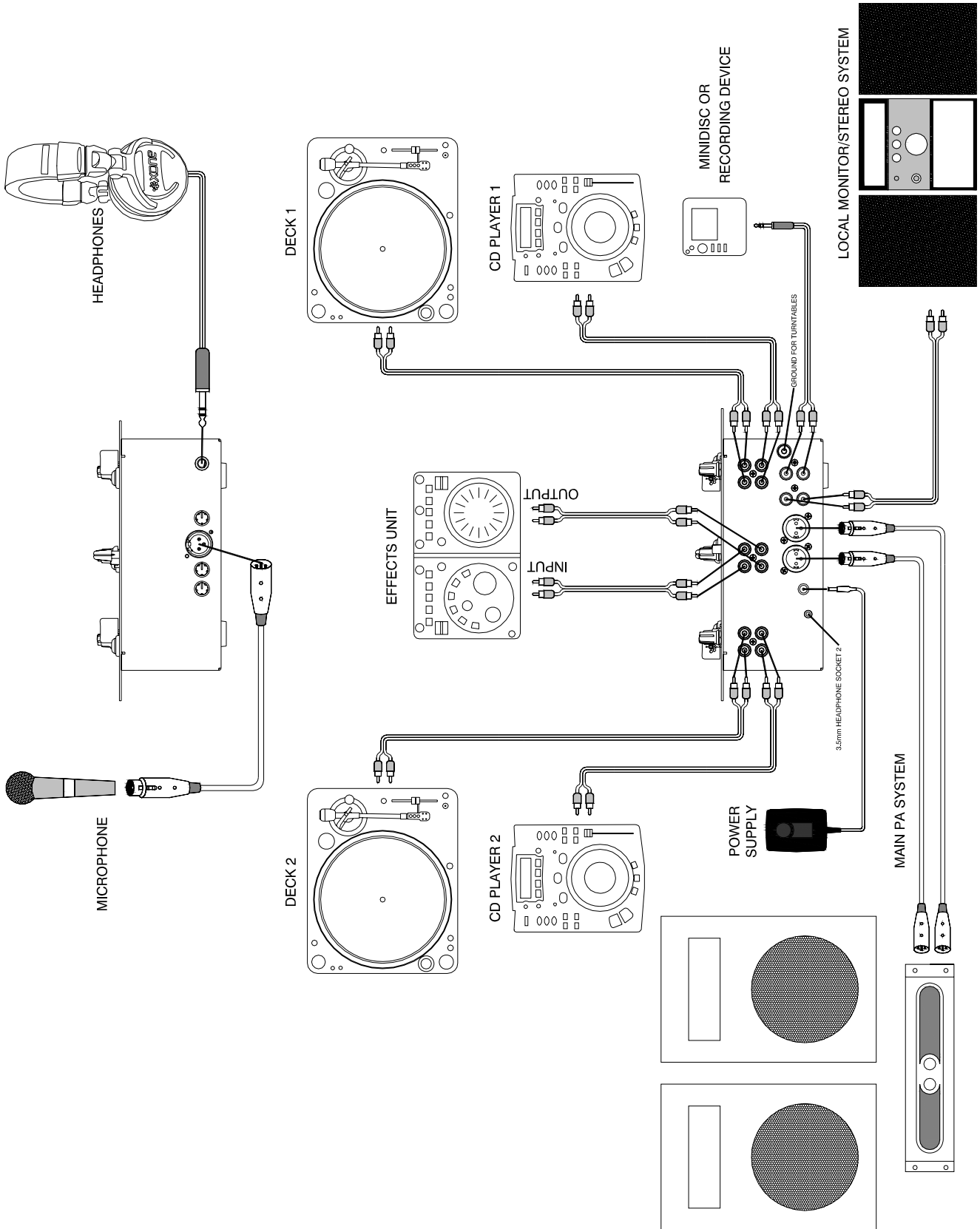

# INTRODUCTION TO THE XONE:22

The Xone:22 has been designed to meet the requirements of those users who want a high quality, affordable, compact DJ mixer. Its feature set has been kept to the essential elements needed to produce professional quality mixes, without compromising the design by adding superfluous gimmicks.

Key features of the Xone:22 are:

- 2 stereo channels with dual phono/line inputs
- 3 Band full cut equalizer
- Voltage Controlled Filter system
- Soft switched (FET controlled) external effects loop
- Accurate signal level monitoring
- Main mix outputs on professional level balanced XLR connectors
- Dedicated local monitor output (booth monitor)
- Pro standard headroom (+18dB) to prevent overload
- +25dBu maximum output level (balanced XLR)
- Low audio distortion (typically 0.002% at +10dBu output)
- Dedicated record output
- Crossfader curve switch
- Cue mix control with cue to master switch
- UV sensitive ink screen for improved low light legibility
- Same high quality components as all other Xone mixers
- Universal voltage power supply (works anywhere in the World)

We wish you the same fun playing on it as we have had designing it!

# INPUT CHANNEL CONTROLS

## **Input level control**

Adjust so that the average music level lights the 0 LED on the meter, with the beats lighting the +3 to +6 LED. Turn down if the +9 Red LED is illuminated

## **Input selector**

Switches between Phono (turntables) and Line (CD)

## **3-Band full kill EQ**

Turn anti-clockwise to kill a frequency band or clockwise to boost.

If all bands are fully clockwise the signal will be muted

## **Channel Meter**

Indicates the signal level through the channel. Adjust the level control so that the peak signal level lights the +3 or +6 LEDs. Reduce the signal level if the red +9 LED lights.

These meters will display the Left/Right channel output signal if the Cue/Master button is pressed

## **Filter/FX Loop switch**

Pressing this switch sends the channel signal to the external effects loop and to the VCF filter section

## **Channel Fader**

High quality fader adjusts the music level for each channel in the mix.

For best signal-to-noise ratio set the fader at, or near, the top when in the mix

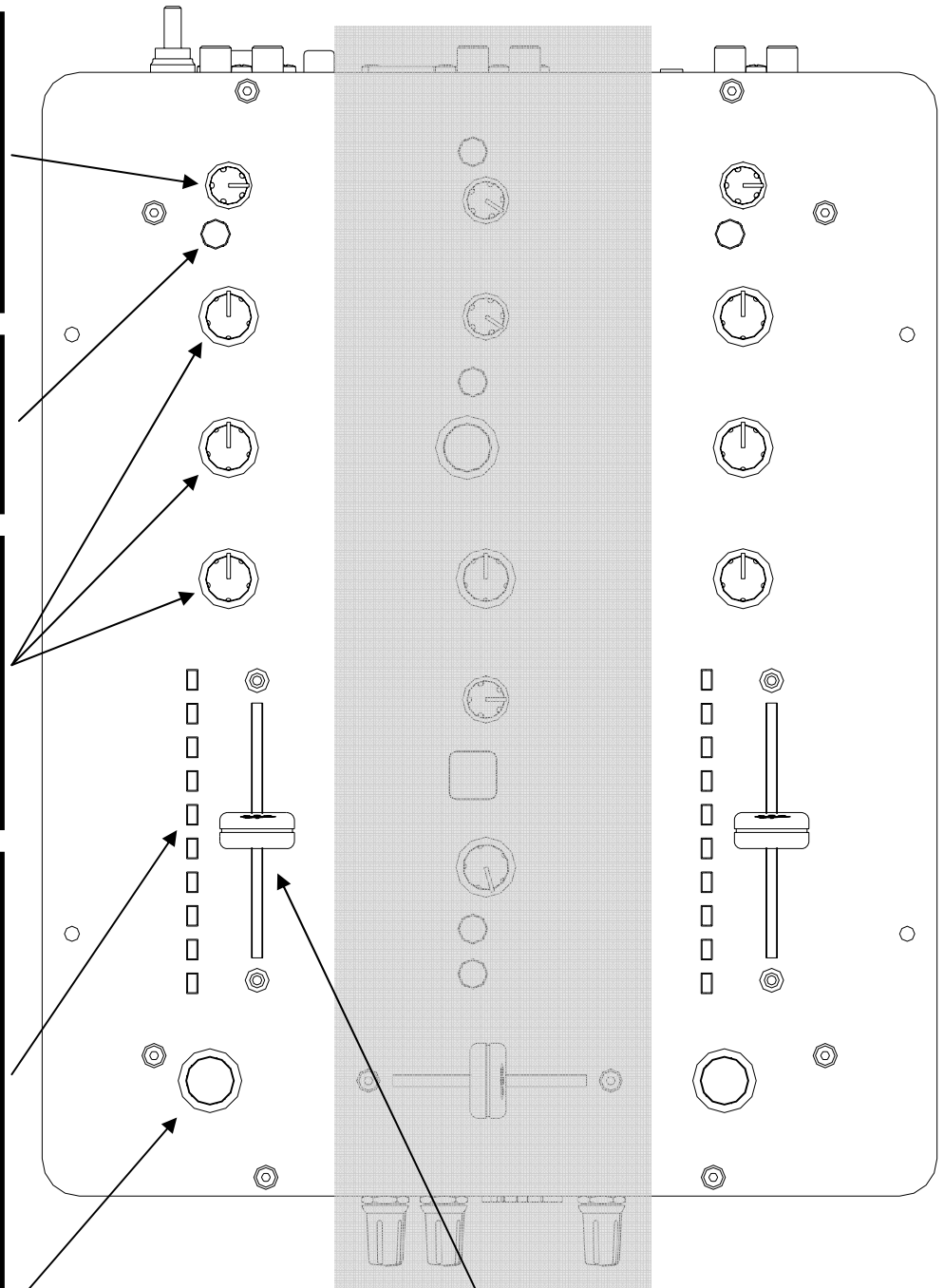

# MASTER CONTROLS

## **FX loop on switch**

Press this switch to activate the external effect loop. Leave switched off if an external effects unit is not connected

## **Master output Level**

Sets the signal level to the main XLR mix output

## **Monitor output Level**

Sets the signal level for the local monitor (booth) output

## **Filter Resonance control**

Changes the “Q” or sharpness of the VCF.

Up (mild) will give a smooth filter sound, Down (wild) will make the filter sound more dramatic

## **Filter type select**

Up (green) selects a low – pass filter, down (red) selects a high - pass filter

## **Filter Frequency**

Sets the cut off frequency of the VCF filter

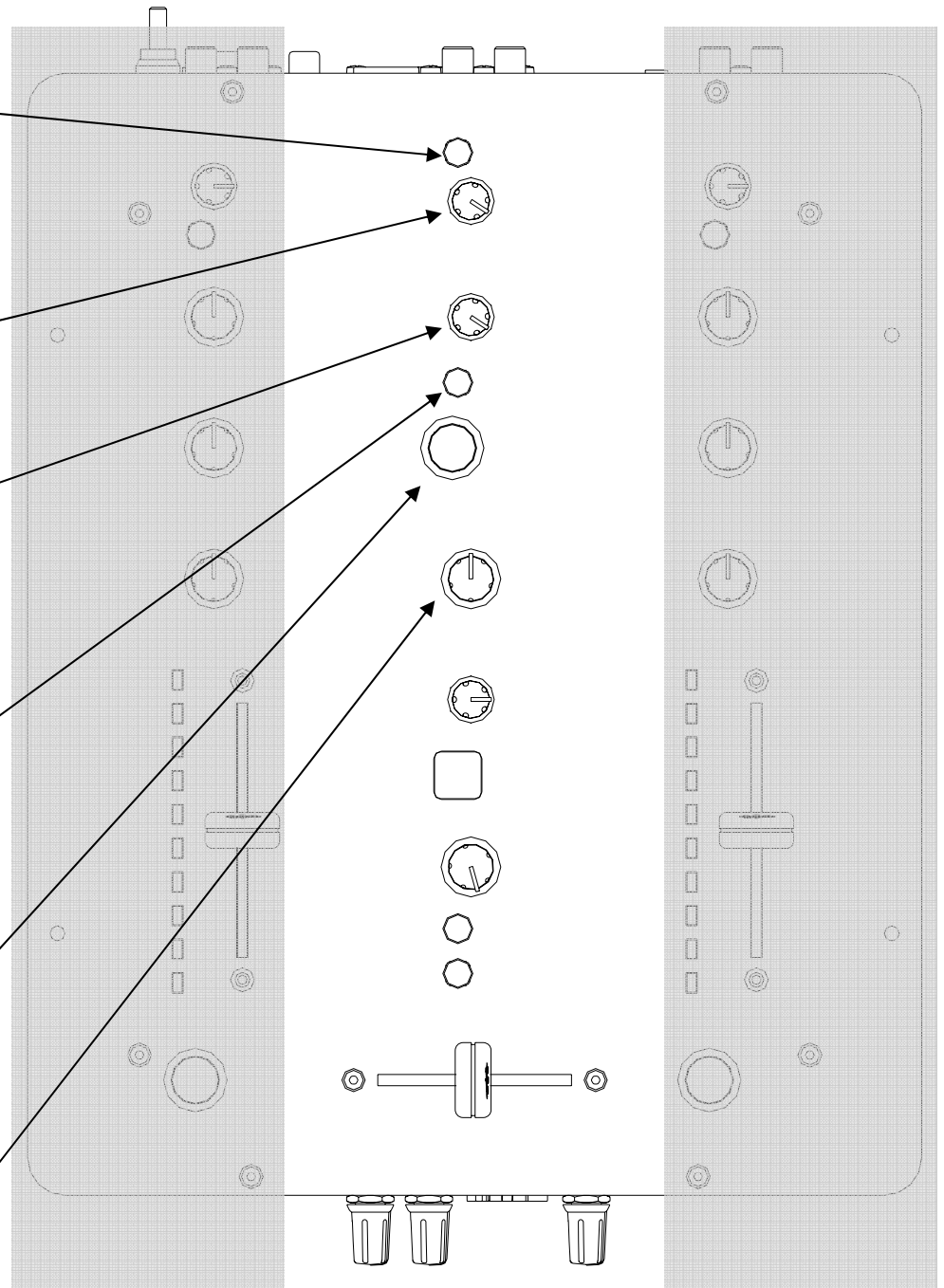



# MASTER CONTROLS continued

## **Headphone level**

Sets the level of the head-phone output.

Warning! Very high level can cause hearing damage!

## **Cue/Master Switch**

In the up position (Cue) the headphones will monitor the channel signal before the faders, and the meters will display the pre fade channel signal level. Press to listen to the main mix output, pre the Master Level control. In this mode, the channel meters will display the stereo mix level, Left = 1, Right = 2.

## **Cue Control**

Pans between Channel 1 and 2 pre-fader signal

## **Crossfader curve switch**

Use the up position to smoothly blend between tracks, and the down position for a faster more aggressive style of mixing

## **Meter Mode**

This switch changes the way the meters display the signal levels, from "bar" mode, where all the LEDs below the peak reading are illuminated, to "dot" mode, where only the peak signal level is displayed.

## **Crossfader**

This is used to "fade" the signal level between the two channels, and its response is set using the curve switch. When the crossfader is fully over to the left only the music from channel 1 will be heard, and when fully to the right only channel 2. When in the centre the music from both channels will be heard in equal proportion.

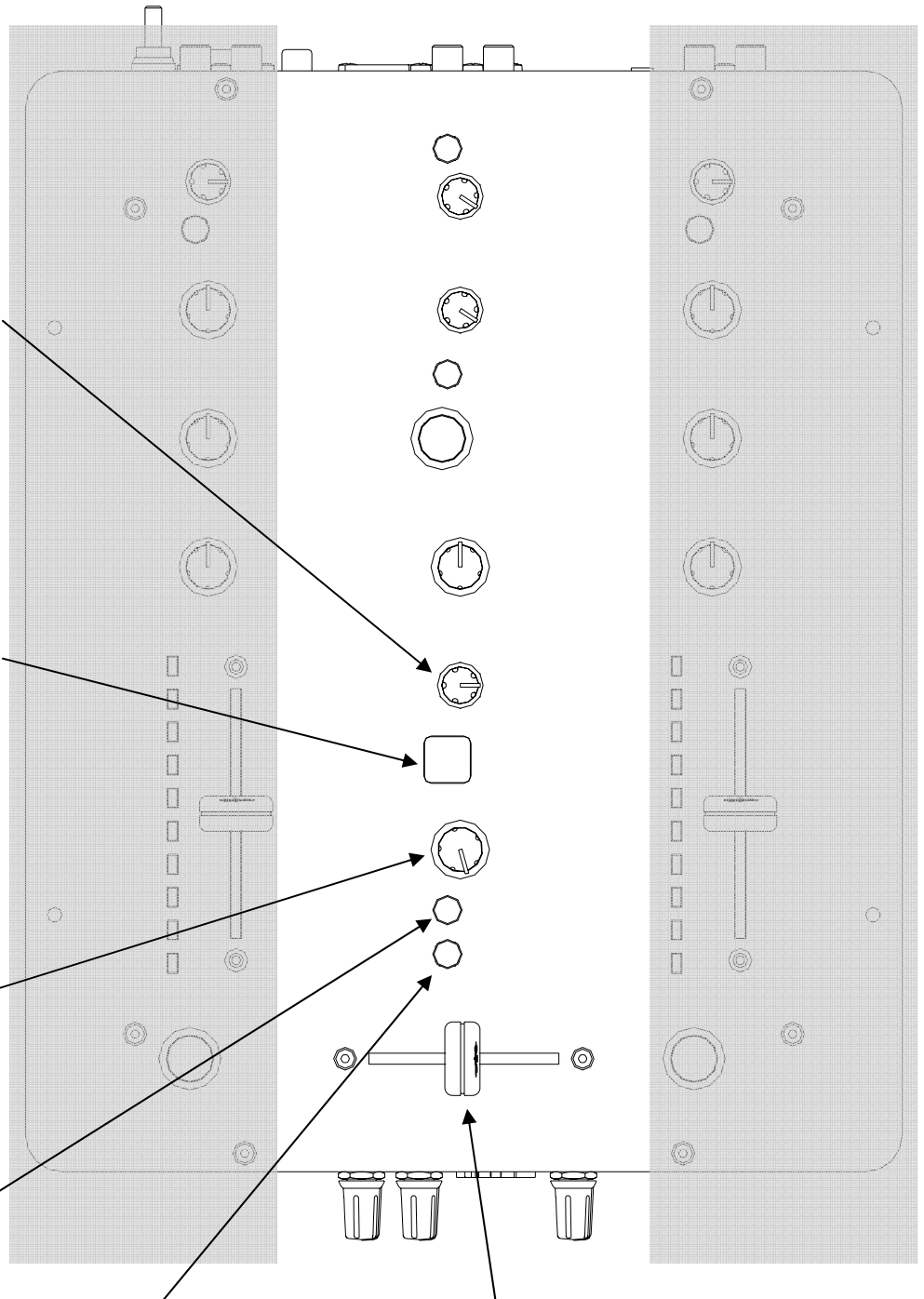

# REAR PANEL CONNECTIONS

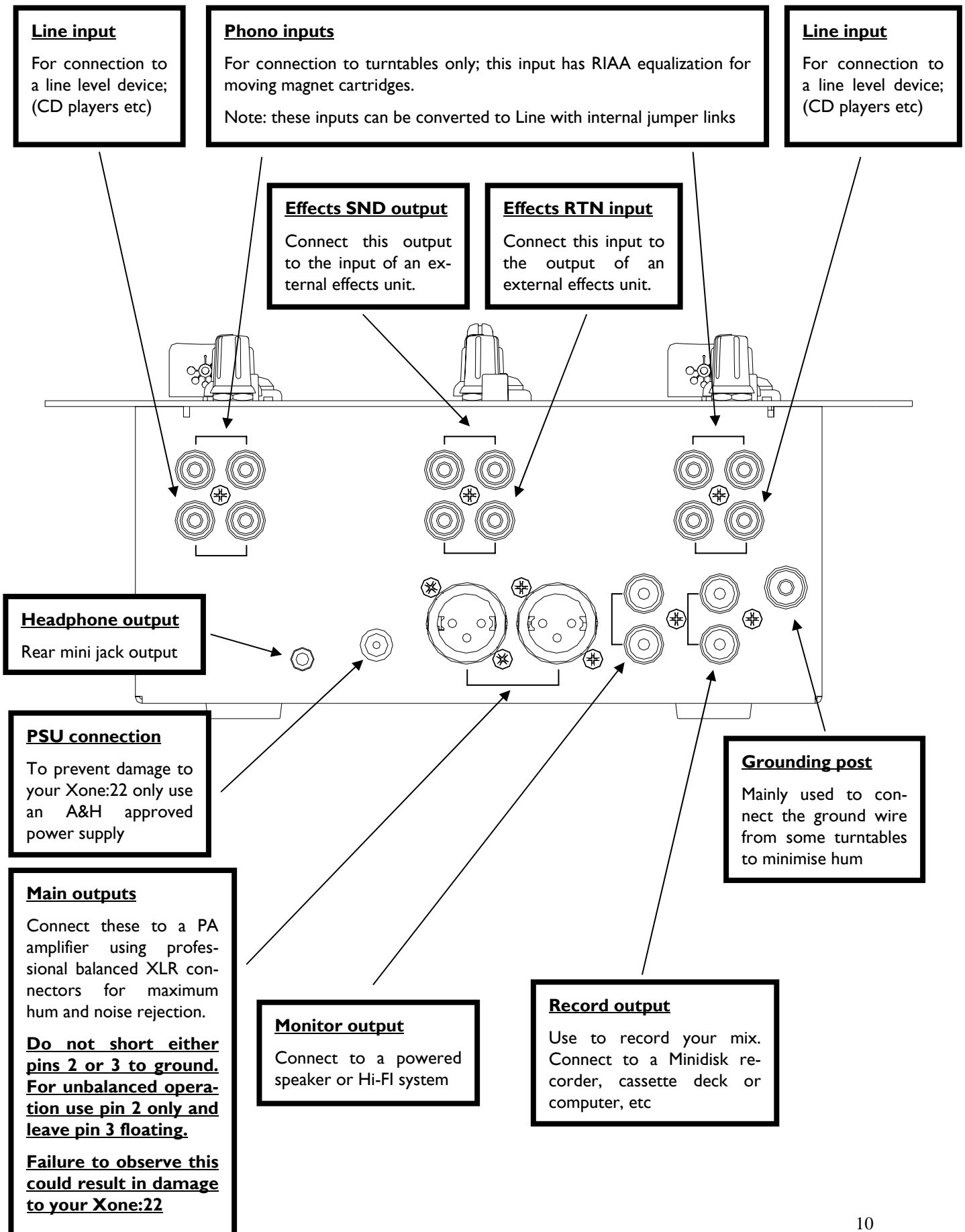

# FRONT PANEL CONNECTIONS

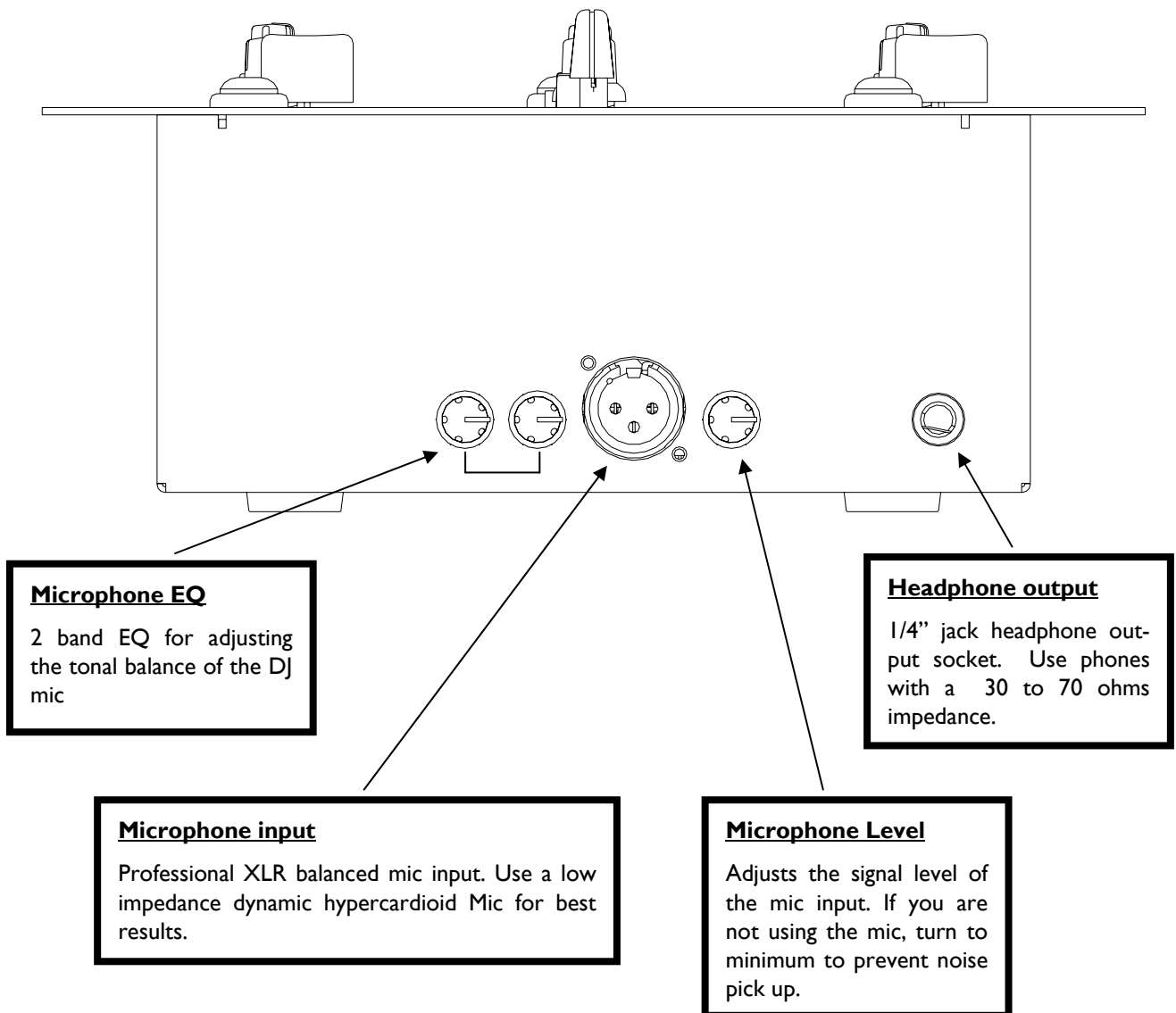

# FILTER REFERENCE

## The VCF Filters

A voltage controlled filter is an audio filter where the cut-off frequency is altered by a DC control voltage rather than a variable resistor. This produces a much wider operating range and more control over the filter response to create unlimited combinations of tonal effect.

## Filter Type Select

The filters provide two simultaneous filter types: high-pass, and low-pass. A large illuminated switch selects which type is active.

The graphs below show the effect on the audio frequency response for the two filter types. The range of sweep from low to high frequency is shown together with the effect of adjusting RESONANCE.

The vertical scale shows the amount of cut or boost around the normal 0dB operating level. The horizontal scale shows the change in frequency from low (bass) to high (treble).

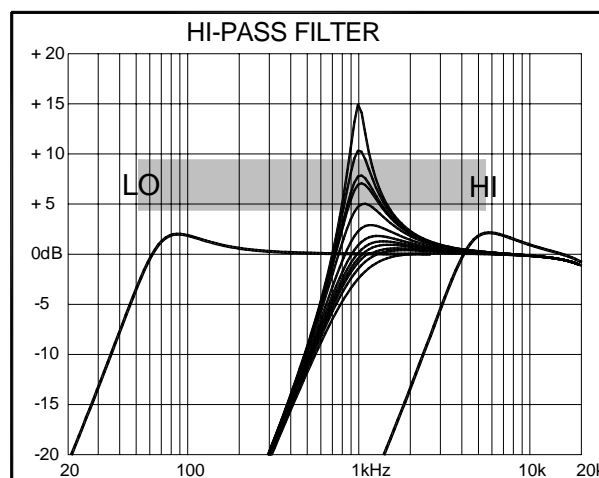
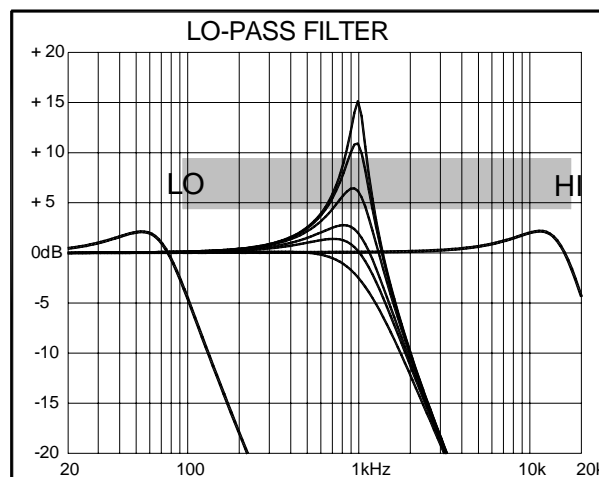

# OPERATING LEVELS

It is most important that the system level settings are correctly set. It is well known that many DJs push the level to maximum with meters peaking hard in the belief that they are getting the best from the system. **THIS IS NOT THE CASE !** The best can only be achieved if the system levels are set within the normal operating range and not allowed to peak. Peaking simply results in signal distortion, not more volume. It is the specification of the amplifier / speaker system that sets the maximum volume that can be achieved, not the console. The human ear too can fool the operator into believing that more volume is needed. Be careful as this is in fact a warning that hearing damage will result if high listening levels are maintained. Remember that it is the **QUALITY** of the sound that pleases the ear, not the **VOLUME**.

The diagram below illustrates the operating range of the audio signal.

**NORMAL OPERATING RANGE.** For normal music the signal should range between  $-6$  and  $+6$  on the meters with average around  $0$ dB. This allows enough **HEADROOM** for unexpected peaks before the signal hits its maximum **CLIPPING** voltage and distorts.

It also achieves the best **SIGNAL-TO-NOISE RATIO** by keeping the signal well above the residual **NOISE FLOOR** (system hiss).

The **DYNAMIC RANGE** is the maximum signal swing available between the residual noise floor and clipping.

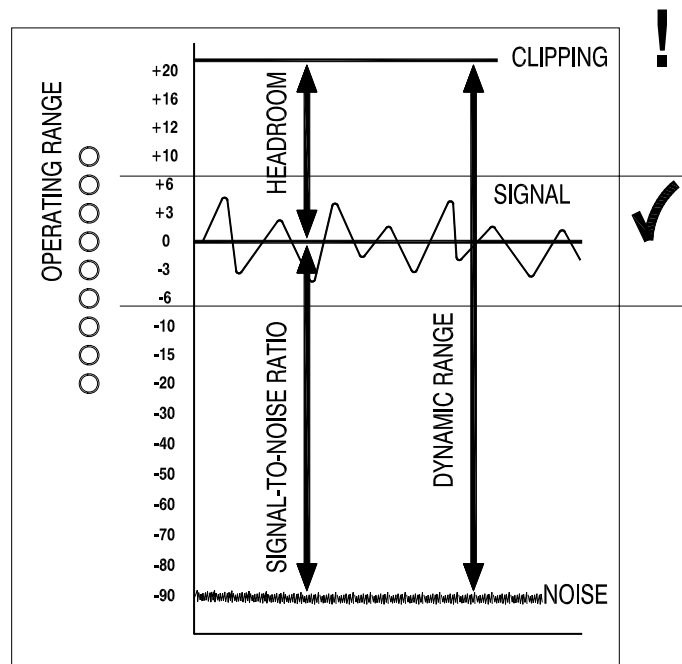

## An important note ...

The human ear is a remarkable organ with the ability to compress or 'shut down' when sound levels become too high. Do not interpret this natural response as a reason to turn the system volume up further! As the session wears on ear fatigue may set in, and the speaker cones may become hot, increasing distortion and reducing the ability of listeners to gain any benefit from increased volume.

# EARTHING

The connection to earth (ground) in an audio system is important for two reasons:



**SAFETY** - To protect the operator from high voltage electric shock, and

**AUDIO PERFORMANCE** - To minimise the effect of earth (ground) loops which result in audible hum and buzz, and to shield the audio signals from interference.

For safety it is important that all equipment earths are connected to mains earth so that exposed metal parts are prevented from carrying high voltage which can injure or even kill the operator. It is recommended that a qualified system engineer check the continuity of the safety earth from all points in the system including microphone bodies, turntable chassis, equipment cases, and so on.

The same earth is also used to shield audio cables from external interference such as the hum fields associated with power transformers, lighting dimmer buzz, and computer radiation. Problems arise when the signal sees more than one path to mains earth. An 'earth loop' (ground loop) results causing current to flow between the different earth paths. This condition is usually detected as a mains frequency audible hum or buzz.

To ensure safe and trouble-free operation we recommend the following:

**Have your mains system checked by a qualified electrician.** If the supply earthing is solid to start with you are less likely to experience problems.

**Make sure that turntables are correctly earthed.** A chassis earth terminal is provided on the console rear panel to connect to turntable earth straps.

**Use low impedance sources** such as microphones and line level equipment rated at 200 ohms or less to reduce susceptibility to interference. The console outputs are designed to operate at very low impedance to minimise interference problems.

**Use balanced connections for microphones and mix output** as these provide further immunity by cancelling out interference that may be picked up on long cable runs.

Do not unbalance the Xone:22 XLR outputs by shorting pin 3 to ground as this may damage the circuitry; for unbalanced operation connect the hot signal to pin 2 and the ground to pin 1. Leave pin 3 floating.

**Use good quality cables and connectors** and check for correct wiring and reliable solder joints. Allow sufficient cable loop to prevent damage through stretching.

**If you are not sure ...** Contact your service agent or local Allen & Heath dealer for advice.

# SERVICING AND JUMPER SETTINGS

## How to replace the channel faders or crossfader

If the faders, especially the crossfader, are subject to a lot of use they will, in time, wear out and need replacing. Intermittent or noisy operation is an indication that they are becoming worn. Using a propriety fader cleaner such as CaigLube might temporarily restore them, but DO NOT use on a new fader as it will wash away the factory applied grease.

Warning! Dismantling your mixer could invalidate the warranty; if you are unsure of your ability to safely carry out this work then it is advised that you leave it to a qualified service technician.

Tools you will need are a T10 and a T8 Torx screwdriver. Ensure that the power supply has been turned off and disconnected from the unit. Using the T8 driver remove the three screws that are located in the centre of the channel input and FX loop connectors (see illustration). Using the T10 remove the 8 screws that hold the front panel to the chassis. Now carefully lift the front edge of the panel up until the PCBs clear the chassis and pull the whole assembly forward slightly until the connectors at the rear are free from the chassis. You can now lift the front panel up to gain sufficient access to replace the faders or change the jumper link settings. Reassembly is a reverse of this procedure. Take great care to ensure that no harnesses become trapped and that all connectors are fully pushed home. Replace the screws and test the mixer for correct operation.

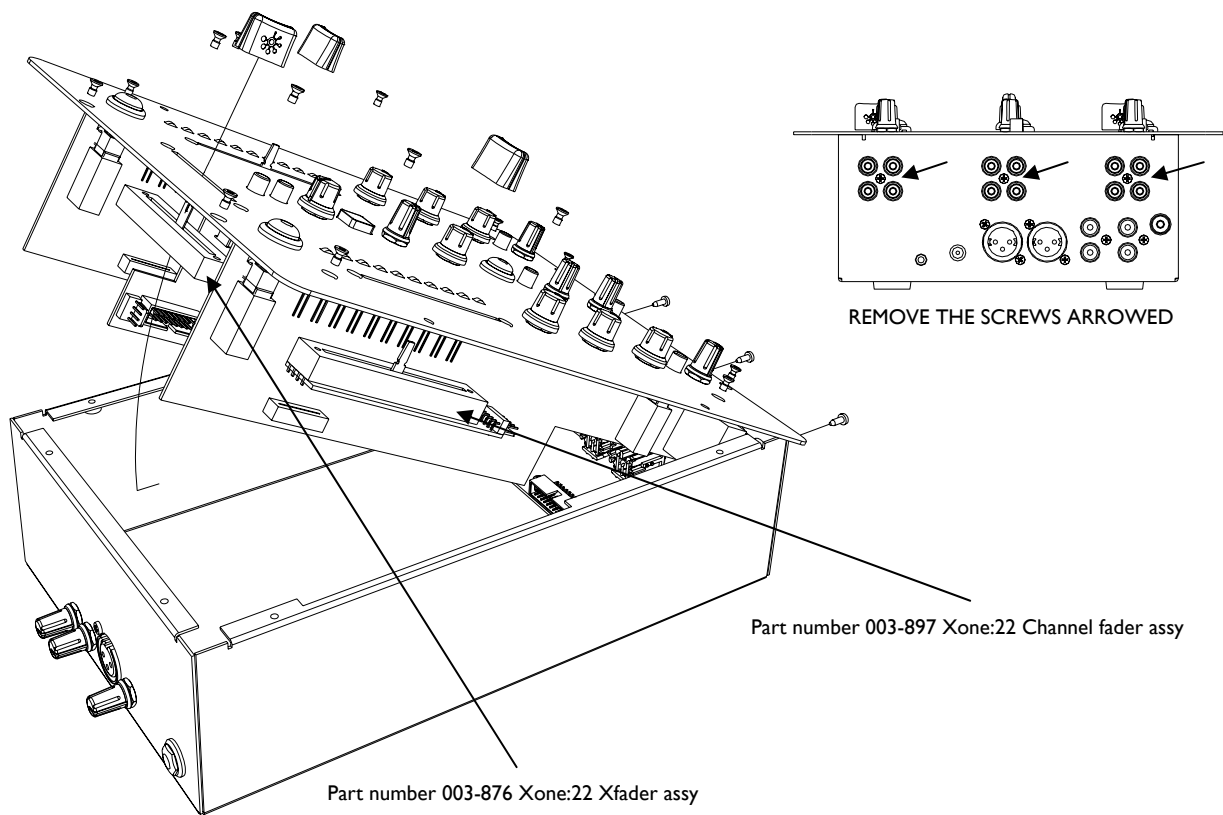

## To change the Phono input to line

Remove the front panel as outlined before. You need to locate and remove the two black jumper links on the input PCBs in the location shown. It is a good idea to leave the jumper links attached to one pin so that they can be refitted at a future date.

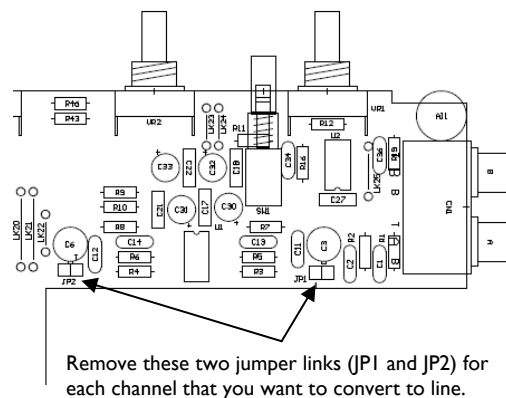

# USER-REPLACEABLE PARTS

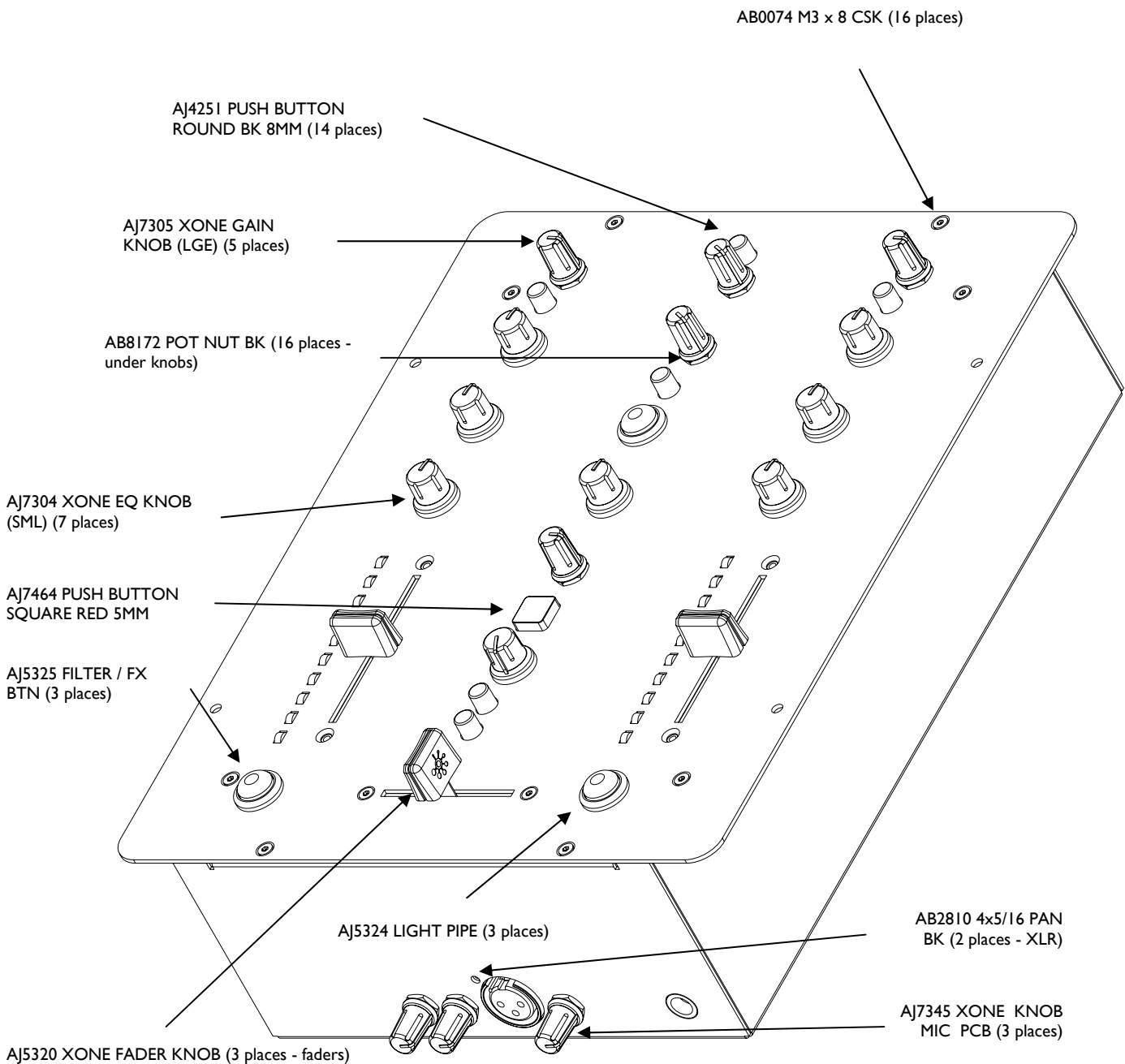

The diagram above shows all of the replacement parts that can be ordered from your local technical support, or direct from Allen & Heath, for the Xone:22. When ordering please quote the part number(s) of the required parts - this makes life easier for us!

See the previous page for information on replacing the crossfader, and for replacement cross-fader assembly numbers.



# FAULT FINDING

## **No sound from mixer**

Check that the unit is powered on, and that an audio signal is connected to a channel input.

Check that the PHONO/LINE switch is in the correct position for the type of music source connected, (PHONO for turntables, LINE for CD players).

Check that the EQ controls are in the centre position.

Raise the input channel LEVEL control until you see the meters displaying the music signal (also check that the CUE/MASTER button is up).

Raise the channel fader, and ensure that the crossfader is towards the channel that is receiving the audio signal.

Raise the level of the MASTER, MONITOR or HEADPHONE level controls depending on what output your amplifier is connected to, or if you are monitoring through headphones.

If the FILTER/FXLOOP switch is on, check that the FXLOOP ON switch (above the MASTER level control) is up.

## **External effects unit can't be heard**

Check that it is connected correctly and switched on; FX LOOP SND on the rear panel of the mixer should be connected to the input socket on the external effects unit, and the output from the effects unit should be connected to the FX LOOP RTN.

Check that the FXLOOP switch is on (pressed down), and that the FILTER/FXLOOP switch below the channel fader is ON.

## **Signal is loud and distorted**

Check that the audio source is connected to the correct input; i.e. don't connect a CD player to the PHONO input.

Adjust the channel input LEVEL so that the Channel meters peak the +3 or +6 LEDs. If the red LED comes on, turn down the channel LEVEL control.

# SPECIFICATIONS

## Connections

### Inputs

	<u>Connection</u>	<u>Impedance</u>	<u>Nominal Level</u>	<u>Maximum Level</u>
Phono	RCA	47K/330pF	7mV-100mV	
Line	RCA	20K ohm	-10 to +18dBu	
FX RTN	RCA	10K ohm	0 to +18dBu	
Mic	XLR	<2K ohm	-42 TO -12dBu	

### Outputs

Main Mix	Balanced XLR	68 ohms	+4dBu	+25dBu
Monitor	RCA	68 ohms	-2dBu	+18dBu
Record	RCA	600 ohms	-10dBV	+10dBV
FX SND	RCA	47 ohms	-2dBu	+18dBu
Headphones	3.5mm and 1/4" TRS Jacks	1 ohm		200mW RMS into 30 ohms

## Performance

Distortion	Main Mix out	+10dBu	0.002% THD+N
Noise 22-22Khz	Main Mix out	unity	-84dBu un-weighted
Fader shut off	Channel fader		>-74dB
Xfade shut off	Xfader		>-80dB
Frequency Response		10Hz to 30kHz	+0/-3dB

## Dimensions

### Weight

2.2kg (5.5lb)

### Weight Packed

3.5kg (8.0lb)

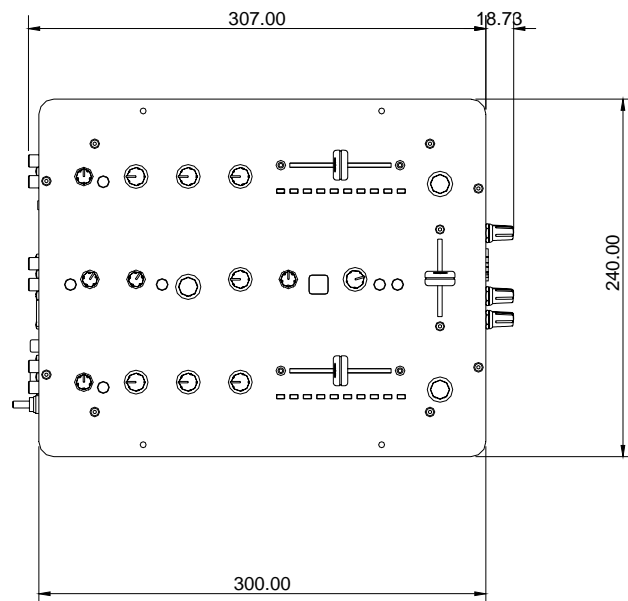
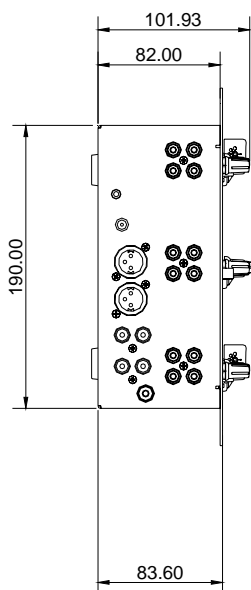

# BLOCK DIAGRAM

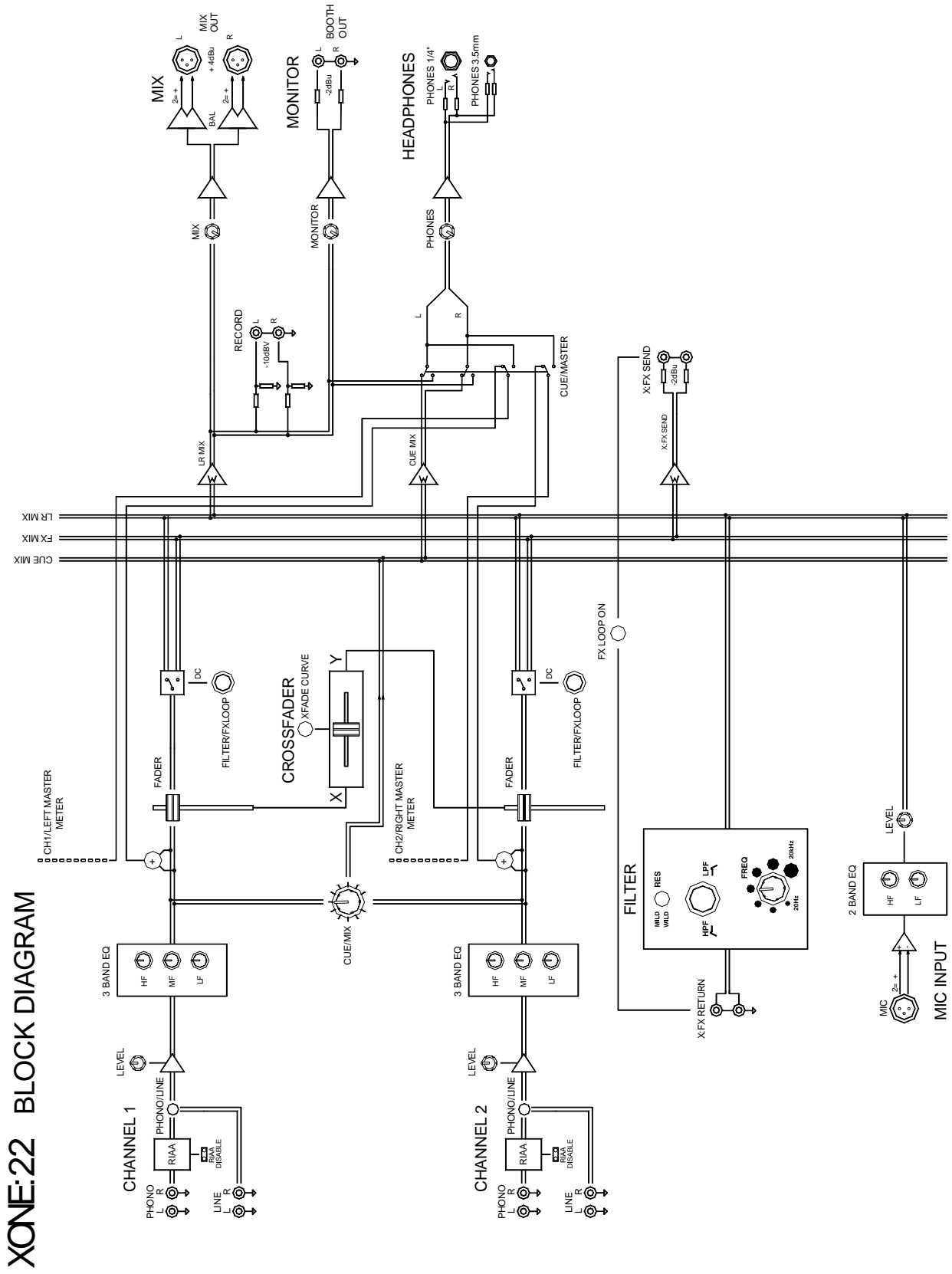

**XONE:22** BLOCK DIAGRAM



# PRODUCT REGISTRATION

## Registering your product

Please go to [www.allen-heath.com/register.asp](http://www.allen-heath.com/register.asp) and register your product's serial number and your details. By registering with us and becoming an official Registered User, you will ensure that any warranty claim you might make is actioned quickly and with the minimum delay.

Alternatively, you may either copy or cut off this section of the page, fill in the details, and return it by mail to:

Allen & Heath Ltd, Kernick Industrial Estate, Penryn, Cornwall TR10 9LU, UK



### ALLEN&HEATH PRODUCT REGISTRATION

Thankyou for buying an Allen & Heath product. We hope that you're happy with it and that you enjoy many years of faithful service with it.

SERIAL  
NUMBER

**Please return this section of the card by mail and retain the other part for your records. You can also register online at [www.allen-heath.com](http://www.allen-heath.com). Thanks for your help.**

Your Name: \_\_\_\_\_

Company Name: \_\_\_\_\_

Address 1: \_\_\_\_\_

Address 2: \_\_\_\_\_

Town/City: \_\_\_\_\_

County/State: \_\_\_\_\_

Country: \_\_\_\_\_

Postcode/Zip: \_\_\_\_\_

Telephone: \_\_\_\_\_

Email: \_\_\_\_\_

Why did you choose this console? \_\_\_\_\_

Which other products did you you consider before choosing A&H? \_\_\_\_\_

Is there any thing you would like to improve on this mixer? \_\_\_\_\_

What audio magazines do you read? \_\_\_\_\_

If you were going to design a mixer for your work, what are the 6 most important features it should have (in order of importance)

1

2

3

4

5

6

We may use the information you provide to inform you of future product developments. We will not give or sell this data to third parties. Please indicate with an 'x' if you do not wish to receive any further communications from us.





