

**HHa**

**Handheld Transmitter**



**Digital Hybrid Wireless®**

US Patent 7,225,135





# Table of Contents

<b>General Technical Description</b> .....	4
<b>Microphone Capsules:</b> .....	6
<b>Mechanical Assembly</b> .....	6
<b>Battery Installation</b> .....	7
<b>IR Sync</b> .....	7
<b>Control Panel</b> .....	7
<b>Setup and Adjustments</b> .....	7
Powering On .....	7
Powering Off .....	8
Standby Mode .....	8
Power Menu .....	8
Battery Condition .....	8
Navigating Menus and Screens .....	8
<b>Input Gain Adjustment</b> .....	10
<b>Side Button Functions</b> .....	11
<b>Mic Capsule Adjustments</b> .....	12
(EXPERT LEVEL ADJUSTMENT) .....	12
<b>Firmware Updates</b> .....	13
<b>Parts and Accessories</b> .....	14
<b>Troubleshooting</b> .....	15
<b>Specifications</b> .....	16
<b>Service and Repair</b> .....	17
Returning Units for Repair .....	17

## Consumer Alert for US Users - FCC Order DA 10-92

Most users do not need a license to operate this wireless microphone system. Nevertheless, operating this microphone system without a license is subject to certain restrictions: the system may not cause harmful interference; it must operate at a low power level (not in excess of 50 milliwatts); and it has no protection from interference received from any other device. Purchasers should also be aware that the FCC is currently evaluating use of wireless microphone systems, and these rules are subject to change. For more information, call the FCC at 1-888- CALL-FCC (TTY: 1-888-TELL-FCC) or visit the FCC's wireless microphone website at [www.fcc.gov/cgb/wirelessmicrophones](http://www.fcc.gov/cgb/wirelessmicrophones). To operate wireless microphone systems at power greater than 50mW, you must qualify as a Part 74 user and be licensed. If you qualify and wish to apply for a license go to: <http://www.fcc.gov/Forms/Form601/601.html>

# General Technical Description

## Introduction

The HHa handheld transmitter uses state-of-the-art Digital Hybrid Wireless® wireless technology, selectable output power and a versatile microphone capsule mounting system to meet the needs of audio professionals and vocalists.

The compandor-free Digital Hybrid audio chain preserves the quality of the selected microphone capsule and delivers it to the sound and recording system without coloration. This superb audio performance and highly reliable RF transmission makes it ideally suited for high end stage and studio production.

## Digital Signal Processor

The DSP encodes the digitized audio from the A-D converter and adds an ultrasonic pilot tone to control the receiver's squelch in systems that use pilot tone. It also controls the input limiter and audio metering.

## Compatibility Modes

The transmitter was designed to operate with Lectrosonics Digital Hybrid Wireless® receivers and will yield the best performance when doing so. Due to the flexibility of digital signal processing, however, the transmitter is also able to operate with Lectrosonics 200 Series, Lectrosonics 100 Series, IFB and certain non-Lectrosonics analog receivers in special compatibility modes. (Contact the Lectrosonics Sales Department for a complete list of compatible receivers.)

## Digital Hybrid Wireless® Technology

All wireless links suffer from channel noise to some degree and all wireless microphone systems seek to minimize the impact of that noise on the desired signal. Conventional analog systems use compandors to increase the signal to noise ratio, at the cost of distortion artifacts. Wholly digital systems defeat the noise by sending the audio information in digital form, at the cost of some combination of power, bandwidth or channel count.

The Lectrosonics Digital Hybrid Wireless® system overcomes channel noise by digitally encoding the audio in the transmitter and decoding it in the receiver, yet still sending the encoded information via an analog FM wireless link. This proprietary algorithm is not a digital implementation of an analog compandor. Instead, it is a technique that can be accomplished only in the digital domain, even though the inputs and outputs are analog signals.

Because it uses an analog FM link, the system enjoys all the benefits of conventional FM wireless systems, such as excellent range, efficient use of RF spectrum, and long battery life. However, unlike conventional FM systems, the design has eliminated the analog compandor and its artifacts.

## Wide Deviation

±75 kHz deviation is used in the Digital Hybrid and 200 Series compatibility modes to dramatically improve the capture ratio, signal to noise ratio and dynamic range of the wireless system. This, in conjunction with accurate input gain adjustment, produces outstanding audio quality that rivals a hard wired connection.

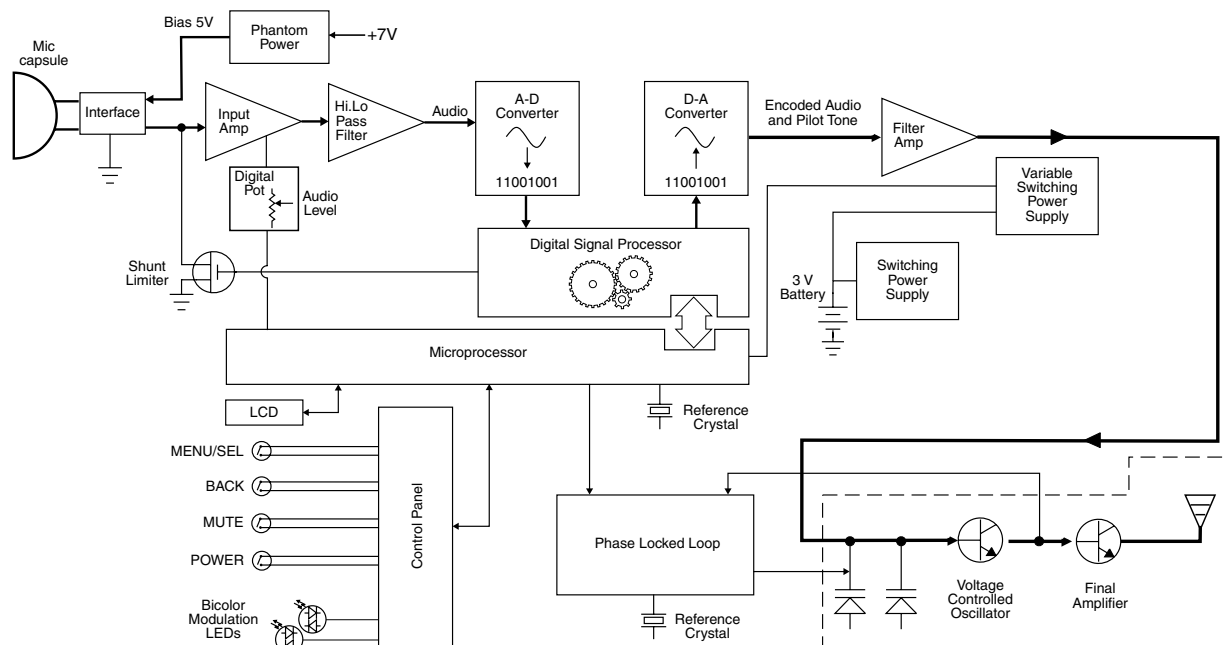

## Pilot Tone Squelch

The benefit of the pilot tone squelch system is that the associated receiver will remain muted until it receives the pilot tone from the matching transmitter, even if a strong RF signal is present on the carrier frequency of the system. All Digital Hybrid Wireless® transmitters use one of 256 different ultrasonic tones between 25 and 32 kHz in each standard frequency band to operate the receiver squelch.

The HHA is a wideband design that tunes across three standard bands (up to 76 MHz). The pilot tone frequency is determined by the selected operating frequency in 100 kHz steps. In other words, the same pilot tone is used for all four frequencies within each 100 kHz step of the tuning range. This preserves compatibility with earlier Digital Hybrid products that tune across a single frequency band (25.6 MHz).

## Input Gain Range and Limiter

45 dB range of input gain adjustment allows gain settings to accurately match the user's voice and the varying sensitivity of different microphone capsules. A DSP-controlled analog audio limiter is employed before the A-D converter. The limiter has a range of more than 30 dB for excellent overload protection. A dual release envelope makes the limiter acoustically transparent while maintaining low distortion. It can be thought of as two limiters in series, a fast attack and release limiter followed by a slow attack and release limiter. The limiter recovers quickly from brief transients, with no audible side effects, and also recovers slowly from sustained high levels to keep audio distortion low while preserving short term dynamics.

## Long Battery Life

Switching power supplies throughout the design allow over 5 hours of operation using two alkaline AA batteries. The battery compartment and contacts are designed to prevent "rattle" as the unit is handled.

## Menu-Driven Control

A high-resolution LCD and control panel with membrane switches provide access to the menu-driven setup. Transmitter RF power, high-pass filter, frequency selection, backlight timeout, mute or talkback functions and tuning modes are easily accessed.

## Wideband Tuning Range

The transmitter can tune across band of up to 76 MHz in either 100 kHz or 25 kHz steps.

## Frequency Selection

Operating frequency is normally selected using a receiver or analyzer to assess signals in the local environment to avoid interference. Once an interference-free frequency is identified, the transmitter frequency is set to match the receiver.

The LCD on the transmitter displays frequency in MHz and with a two character hex code that is used on most Lectrosonics receivers.

## Antenna

A newly designed helical antenna allows the transmitter to be held in any position, since the user's hands have little or no effect on the RF output power.

## Microphone Capsules

The transmitter is available from Lectrosonics with the HHC and HHVMC cardioid condenser capsules. Capsules from several other manufacturers are also available for use with the HH: those with a 1.25" x 28 thread pitch and three contact rings. Condenser or dynamic microphone heads can be used with the HH, depending on the user's preference or the application.

## IR (infrared) Sync

An IR Sync Port is used for quick setup with receivers that offer this feature. Settings for frequency, step size and compatibility mode are transferred from receiver to transmitter via the IR ports.

## Side Button Functions

A programmable switch on the side of the housing can be configured as a mute/cough switch, to provide a talkback function, a power switch, or be disabled.

The talkback function provides a communication channel when used with a receiver equipped with this feature, such as a Venue Wideband receiver with appropriate firmware. When pressed and held in, the side switch re-directs the audio output to a different audio channel on the receiver. As soon as the switch is released, audio is returned to the program channel.

The talkback function works only in the Digital Hybrid compatibility mode.

## USB Port for Firmware Updates

Firmware updates are enabled by simply downloading a file and utility program from the Lectrosonics web site, connecting the transmitter to a computer via the USB port and running the program.

## Mechanical Assembly

A mic capsule is threaded onto the body of the transmitter in the direction shown. Do not overtighten it.

The lower housing opens by rotating it in the direction shown. After the threads are disengaged, pull the housing downward until it engages the detent that holds it open.

The threaded interface is a 1.25" diameter opening with 28 threads per inch and three contact rings

## Microphone Capsules:

Lectrosonics offers two types of capsules. The HHC is the standard capsule and the HHVMC is the Variable Mic Capsule which includes adjustments for Bass, Midrange and Treble.

Do not touch the contacts between the mic capsule and transmitter body. When necessary, the contacts can be cleaned with a cotton swab and alcohol.



HHC Lectrosonics cardioid electret



HHVMC Lectrosonics cardioid electret with VariMic preamp

Along with these two models from Lectrosonics, a variety of different capsules with a common thread and electrical interface are available from the major microphone manufacturers.

A list of compatible capsules is on the website at [www.lectrosonics.com](http://www.lectrosonics.com) listed on the HH transmitter page.



## Capsule Installation

Capsules are attached with a right-hand thread.

To remove the windscreen from the mic capsule, line up the blue wrench (included with the capsule head) with the flat notches on the lower threaded area of the mic capsule.

Align flats on the wrench with flats on the capsule.



\*All product names are trademarks of their respective owners, which are in no way affiliated with Lectrosonics.



## Battery Installation

To insert batteries, close the eject lever and insert the upper contacts first (closest to the mic capsule). Polarity is marked on the label in the bottom of the battery compartment.

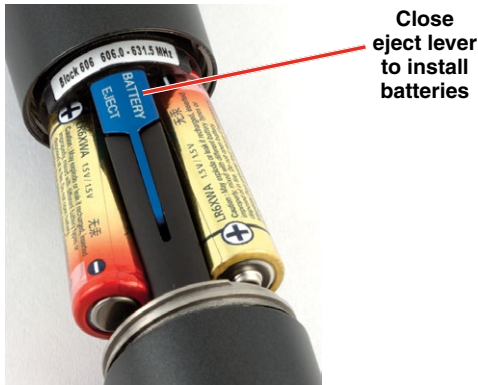

To remove the batteries, pull the eject lever outward. The battery tips will move outward, making them easier to grasp.

Pull eject lever outward to release batteries from contacts

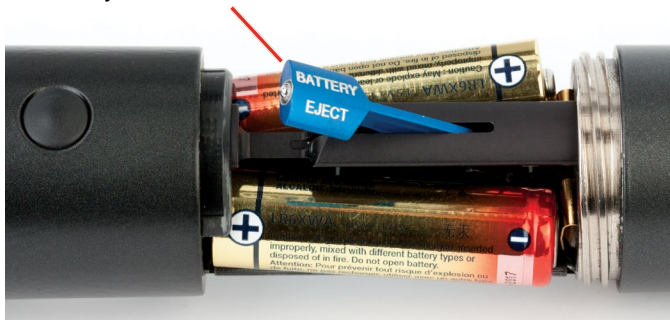

The contacts are very tight to prevent the batteries from “rattling” as the transmitter is being handled.

## IR Sync

The IR SYNC (infrared sync) port is used with receivers that offer this feature. Settings stored in the receiver for frequency, step size and compatibility mode are transferred to the transmitter via the infrared ports. To use this feature, open the housing on the transmitter to expose the control panel. Hold the transmitter near the receiver (less than 3 feet away) so the IR ports face each other. The transfer is triggered by a switch on the receiver. The LCD on the transmitter will display a message confirming that the settings were successfully transferred, or an error message that identifies the problem that occurred.

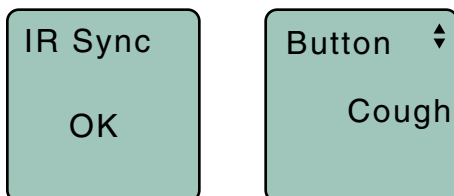

## Control Panel

Six membrane switches on the control panel are used to set up the transmitter by navigating the menus on the LCD and selecting the desired values.



## Setup and Adjustments

### Powering On

Press and hold the *Power Button* for several seconds until a countdown on the LCD is completed. The countdown from 1 through 3 will appear on the LCD, followed by a display of the model, firmware version, frequency band and compatibility mode.

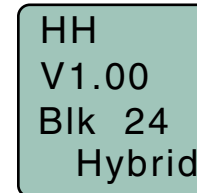
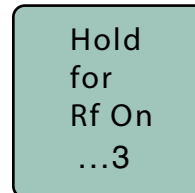

When you release the button, the unit will be operational with the RF output turned on and the *Main Window* displayed.

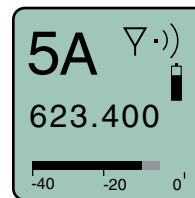

The Main Window

**NOTE:** If the *Power Button* is released before the countdown is completed, the unit will boot up in the “standby” mode with the RF output turned off.

## Powering Off

Press and hold the *Power Button* (or the side button if it is configured for turning the power on and off) for several seconds and observe the countdown on the LCD. The countdown on the LCD will progress from 3 to 1 and the power will then be turned off. This can be done from any menu or screen.

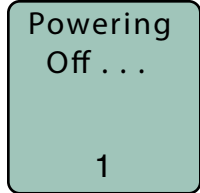

**NOTE:** If the *Power Button* is released before the countdown is completed, the unit will remain turned on and the LCD will return to the same screen or menu that was displayed previously.

## Standby Mode

A brief push of the *Power Button* turns the unit on and places it into a “standby” mode (not transmitting). This allows the transmitter to be set up without the risk of creating interference for other wireless systems that are operating in the vicinity.

A notice will appear briefly confirming that the RF output of the transmitter is turned off, followed by the *Main Window*. The antenna symbol will blink as a reminder that the RF output is turned off.

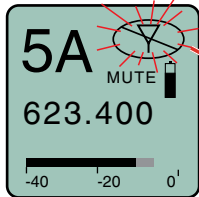
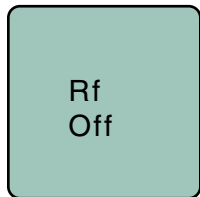

Symbol blinks when RF output is turned OFF

## Power Menu

When the transmitter is turned on, a brief push of the *Power Button* will reveal a menu allowing you to choose between **Resume**, **Rf On?**, and **Pwr Off?**.

Use the UP/DOWN buttons to select one of the menu items, then press the *MENU/SEL* button to confirm this action. The **Rf On?** selection will enter another screen prompting a Yes or No answer.

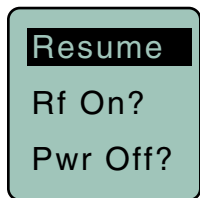

- **Resume:** Continue operating in the same condition as before.
- **Rf On?:** Begin transmitting the RF signal.
- **Pwr Off?:** Turns off the transmitter.

The unit can also be turned off from any menu or screen on the LCD by holding the power button in for the duration of the countdown.

## Battery Condition

An icon on the *Main Window* indicates the remaining power of the transmitter batteries. This battery gauge is most accurate with the typical voltage drop across the life of alkaline batteries.

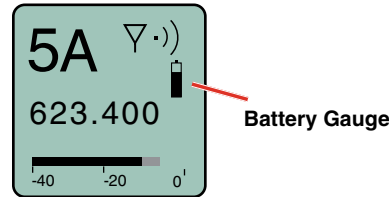

Rechargeable batteries give little or no warning when nearing depletion. If you use rechargeable batteries in the HH, we recommend trying fully charged batteries first, noting the length of time that the batteries will run the unit, and in the future using somewhat less than that time to determine when the battery needs to be replaced. The Venue and other receivers from Lectrosonics offer a timer function to assist in this process.

## Navigating Menus and Screens

The *Main Window* displays the following information:

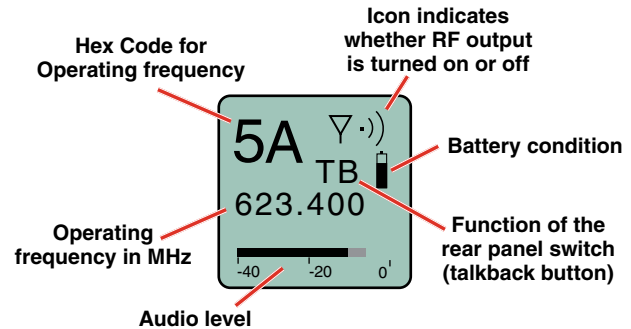

- 1) Press the *MENU/SEL* button to enter the setup menu. Use the UP/DOWN buttons to highlight the menu item.
- 2) Press the *MENU/SEL* button to enter the setup screen for that item. Use the UP/DOWN buttons to select the desired value or mode.

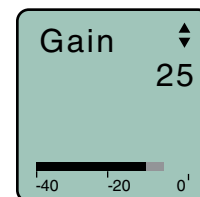

- 3) Press the *MENU/SEL* button to save this setting and return to the previous screen.
- 4) Press the *BACK* button to return to the *Main Window*.



### Gain

This setting is very important since it will determine the audio signal to noise ratio and dynamic range that the wireless system will deliver. Gain must be set according to the individual voice, the mic capsule in use and the handling technique of the user. LEDs in the control panel facilitate accurate gain adjustment.

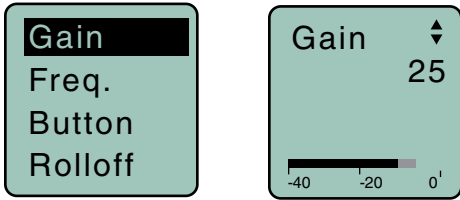

**IMPORTANT:** See the section *Input Gain Adjustment* on page 10 for details.

### Freq.

The operating frequency is normally determined using the scanning function in the receiver or with coordination software. The frequency is shown on the transmitter LCD display in MHz and with a hexadecimal code that is used on most Lectrosonics receivers.

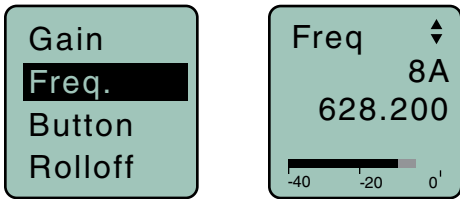

### Button

The *Side Button* on the housing can be set to provide several functions, or it can be bypassed.

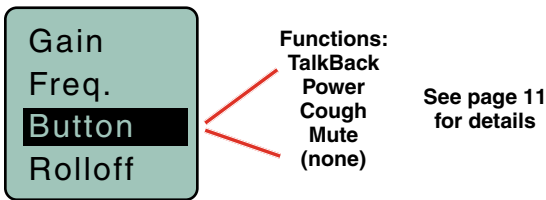

### Rolloff

A low frequency roll-off filter can be set for a -3dB point at 35, 50, 70, 100 or 125 Hz. Roll-off slopes are 12.2 dB/octave at 35 Hz and 10.1 dB/octave at 70 Hz through 125 Hz.

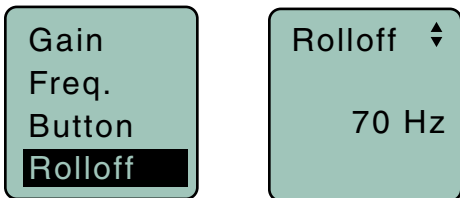

The roll-off frequency is normally adjusted by ear to suit personal preferences.

### Compat

The HH can be used with earlier Lectrosonics wireless and IFB systems and systems from other manufacturers by selecting the correct *Compatibility Mode*. The receiver must be set to the same mode.

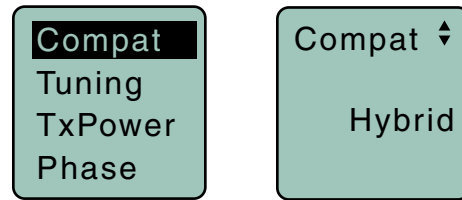

The available modes are as follows:

- **Hybrid** Digital Hybrid receivers
- **Mode 3** (other brand contact the factory)
- **200 Mode** Earlier Lectrosonics receivers
- **100 Mode** 100 Series Lectrosonics receivers
- **Mode 6** (other brand contact the factory)
- **IFB Mode** Lectrosonics IFB receivers

### Tuning

The frequency can be adjusted in 100 kHz or 25 kHz steps to match the receiver. 100 kHz is the standard increment for Lectrosonics wireless systems, but 25 kHz increments may be needed for use with systems from other manufacturers or when frequency coordination requires it.

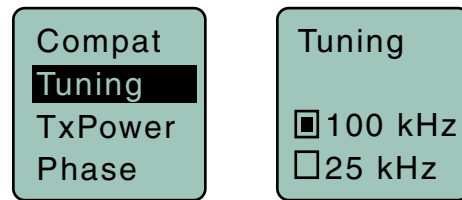

The Hex Code on the Main Screen will be smaller in the 25 kHz mode and a fraction will appear next to the characters if a frequency in between even 100 kHz steps is selected.

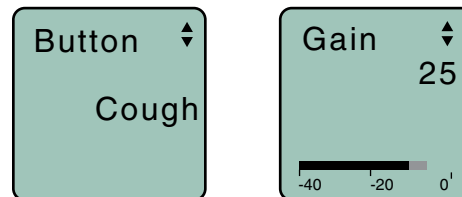

### TxPower

Output power can be set to 100 mW to extend operating range (which can also suppress noise and drop-outs to some extent) or set to 50 mW to slightly extend the operating life of the batteries.

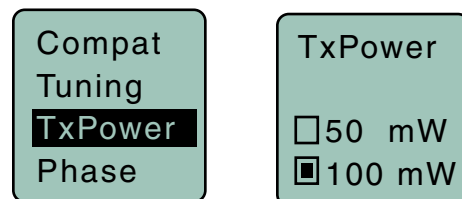

### Phase

The phase (polarity) of the audio can be inverted to match other microphone capsules as needed.

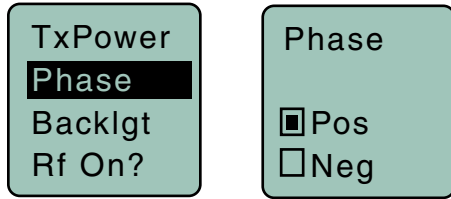

### Backlgt

The LCD includes a backlight that illuminates the display for easier viewing in dim lighting conditions. It is set to come on when any button on the control panel is pressed, then stay on for either 30 seconds or 5 minutes, or to stay on all the time.

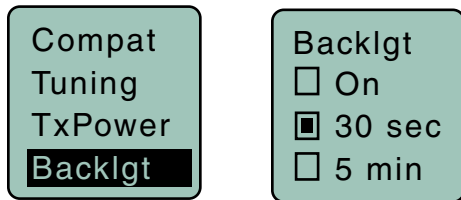

### Rf On?

The transmitter output can be switched on or off with this menu item. This is useful, for example, when the transmitter is in the “standby” mode during setup, allowing it to be turned on for normal operation without having to cycle the power.

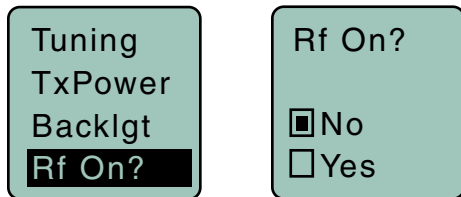

This menu item can also be used to change the transmitter to the “standby” mode with the RF output turned off for additional setup.

### Default

The default setting simple returns the transmitter back to the factory settings and any of the menu items can be readjusted from that default point.

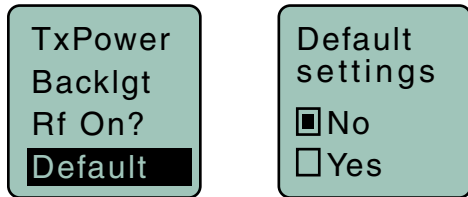

## Input Gain Adjustment

The two bicolor Modulation LEDs (located at the bottom of the control panel) provide a visual indication of the audio signal level entering the transmitter.

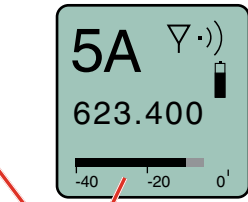

The

The audio level is shown by LEDs and in the LCD screen.

The gain should be set so that the -20 LED just turns red on the loudest peak (the onset of limiting).

LEDs will glow either red or green to indicate modulation levels as shown in the following table.

Signal Level	-20 LED	-10 LED
Less than -20 dB	● Off	● Off
-20 dB to -10 dB	● Green	● Off
-10 dB to +0 dB	● Green	● Green
+0 dB to +10 dB	● Red	● Green
Greater than +10 dB	● Red	● Red

It is best to go through the following procedure with the transmitter in the “standby” mode so that no audio will enter the sound system, which could cause feedback.

- 1) With fresh batteries in the transmitter, power the unit on into “standby” (no transmission) mode.
- 2) Press the *MENU/SEL* button once to enter the setup menu. Use the UP/DOWN buttons to select *Gain*. Press the *MENU/SEL* button again to enter the setup screen.
- 3) Hold the microphone the way it will be used in actual operation.
- 4) Speak or sing at the same voice level that will actually be used during the program, while observing the modulation LEDs. Use the UP/DOWN buttons to adjust the gain until the **-20 dB** LED starts to flicker red and the **-10 dB** glows green.
- 5) Once the audio gain has been set, the signal can be sent through the sound system for overall level adjustments, monitor settings, etc. To do this, the unit must be set to transmit (see **Powering On and Off**, and the **Standby Mode** on page 7).

NOTE: Full modulation is achieved when the -20 LED first turns red. 30 dB of clean limiting is available above this point.

# Side Button Functions

NOTE: The Power and Cough functions were added starting with serial number 1001.

A special button (the **Side Button**) on the outside of the housing can be configured to provide a several different functions, or to be inoperative.

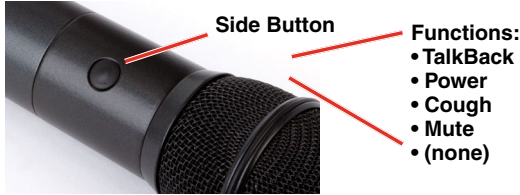

The **Side Button Setup Switch** on the control panel opens a setup screen to set the **Side Button** function. Enter this setup screen and then use the UP/DOWN arrows to select the desired function, then press the MENU/SEL button to return to the *Main Window*.

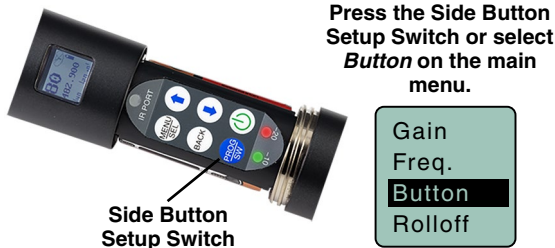

The button menu provides a scrollable list of the available functions. Use the UP/DOWN arrows to highlight the desired function and press BACK or MENU/SEL to select it and return to the main menu.

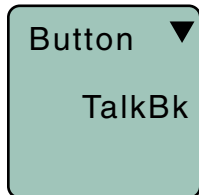

**Talkback** is a “push to talk” function that is active only while the button is pressed. The talkback function provides a communication channel when used with a receiver equipped with this function, such as a Venue Wideband receiver with firmware

Ver. 5.2 or higher. When pressed and held in, the side button re-directs the audio output to a different audio channel on the receiver. As soon as the switch is released, audio is returned to the program channel.

NOTE: The **Talkback** function is only available in the Digital Hybrid compatibility mode. An error message will appear if **Talkback** is selected while in another mode.

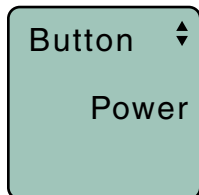

**Power** turns the power on and off. Hold the button in until the countdown sequence from 3 to 1 is completed. The power will then be turned off.

(additional information on page 7)

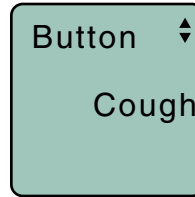

**Cough** is a momentary mute switch. Audio is muted while the button is held in.

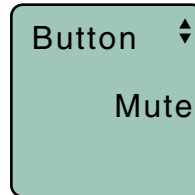

**Mute** is a “push on/push” off function that toggles on and off each time the **Side Button** is pressed. The mute function defeats the audio in the transmitter, so it works in all compatibility modes and with all receivers.

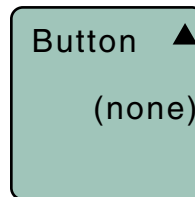

(none) disables the switch.

For detailed information on setting up the **Talkback** function and the Venue receiver, refer to the Installation Guide for the Venue Wideband Receiver.

## Main Window Displays for Mute and Talkback Functions

The function of the **Side Button** is displayed in the LCD *Main Window*.

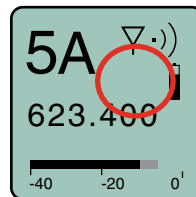

None/Power

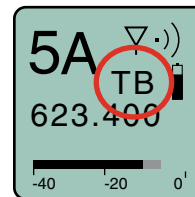

Talkback

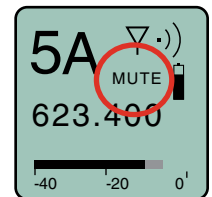

Mute/Cough

When the **Side Button** is pressed, the function will be active and the LCD will display an indication.

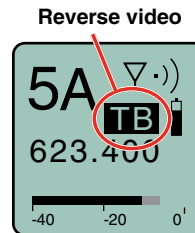

Talkback active



Mute active  
(MUTE blinks)

# Mic Capsule Adjustments

## (EXPERT LEVEL ADJUSTMENT)

These adjustments significantly alter the gain and tonal quality of the microphone, and are to be used only in special circumstances.

**Caution:** Always make the final decision about sound quality with the windscreen in place.

Remove the windscreen using the supplied wrench.

Align flats on the wrench with flats on the capsule.

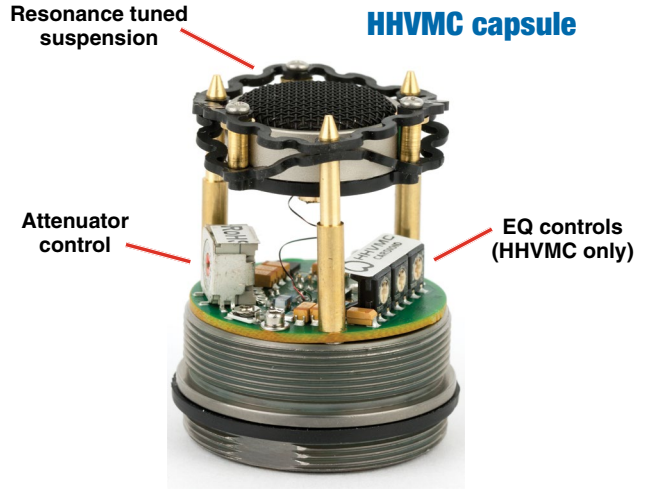

**IMPORTANT:** Be sure to set the attenuator control back to its original setting ("F") for normal operation. or a subsequent user may think the unit is malfunctioning or has a poor signal to noise ratio.

## Attenuator Adjustment

The HHC & HHVMC heads include an attenuator in the preamp circuitry to provide an additional 15 dB of headroom when needed for extremely loud voices.

The attenuator should **ONLY** be used **when the gain control is already turned all the way down** and the audio is still driving the preamp into significant limiting where both -20 and -10 dB LEDs stay lit all or most of the time during peaks in the audio.

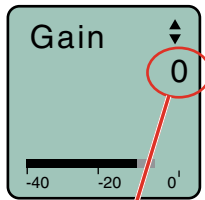

Gain set to minimum (0) on the LCD.



LEDs on control panel

The attenuator control is a 16 position switch that attenuates the audio in 1 dB steps. It is marked **0** through **F** where **F** is minimum attenuation and **0** is maximum attenuation. Rotating it clockwise increases the loudness, and counter clockwise decreases the loudness.

Attenuator switch set at F for normal operation.

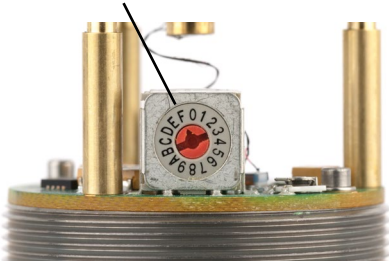

## LO/MID/HI (bass/mid/treble) - HHVMC only

The HHVMC head includes VariMic™ equalization adjustments to boost or cut the frequency response in LOW, MID and HIGH ranges. The LOW and HIGH controls will boost/cut by up to 8 dB while the MID control will boost/cut up to 6 dB.

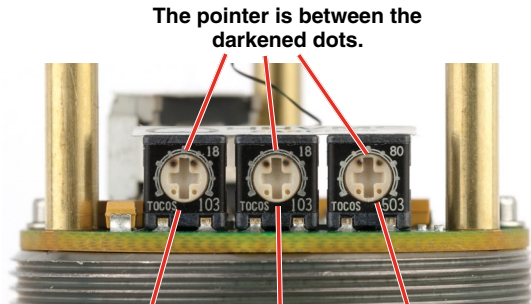

LOW MID HIGH  
The controls are set to "zero" (no boost or cut) in this photo

These controls operate as standard tone controls in that a counterclockwise adjustment cuts the response in that band and a clockwise adjustment boosts the response.

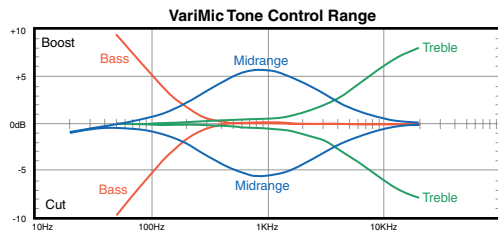



## Firmware Updates

As of the date of this writing, the firmware update program runs only on a Windows operating system.

Updating the firmware is simply a matter of downloading a utility program and file from the web site and running the program with the receiver connected to a computer via the USB port.

Go to [www.lectrosonics.com/US](http://www.lectrosonics.com/US). Click on SUPPORT in the top bar, then click on the link to the HHa transmitter in the CATEGORIES pane on the right side of the page. Click on the link labeled Firmware Updates at the bottom of the page. Download the Firmware Updater program zip file and extract it to a temporary folder on your computer. Then download and extract the firmware zip file (e.g. xxxx\_16.zip) and extract it to a temporary folder on your computer.

Remove the lower housing of the transmitter by unscrewing it from the housing attached to the capsule and pulling it straight off the body of the transmitter to expose the circuitry. Spring-loaded ball detents provide a “stop” with only the control panel exposed. Continue to pull the lower housing farther to remove it. Simply push the lower housing back onto the transmitter body to re-install it.

The USB port on the transmitter requires a micro-B male plug on the connecting cable. The other end of the cable would normally be a USB A-Type male connector to fit the most common type of USB jack used on computers.

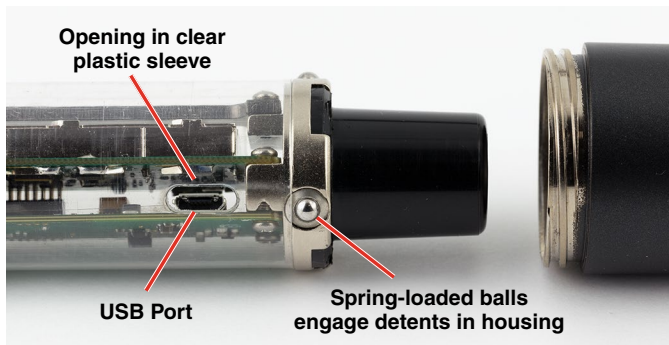

Hold down the BACK and UP arrow buttons on the transmitter control panel while powering it up. The LCD will display UPDATE to confirm it is in this mode.



Connect the USB cable and run the utility program. The program will automatically detect the transmitter and prompt for the location of the firmware file. Point at the file and click on **Start**. The process takes about 90 seconds. A message on the computer screen will confirm the update is complete. Turn the transmitter off and disconnect the USB cable. Turn the transmitter back on again in the normal mode to verify it is working correctly.



# Parts and Accessories

## #55008 - Blue Battery Caddy



## #CCHH - Zippered Pouch

Padded zipper pouch for handheld transmitter



## #26872 Mic Capsule Wrench

Custom wrench for removing windscreen from mic capsule



## #13585 Mic Clip

Screw on mic clip for standard mic stands with 5/8"-27 thread



## HHXTND

Extender to for use with microphone flags commonly used in ENG for network or station ID to keep the flag from covering the side switch and LCD



## HH2SEN Adapter

Adapts Sennheiser G2, G3 and 2000 Series microphone capsule heads to the HH transmitter.

Transmitter interface



Capsule interface



## HHA Adapter by Ambient Recording



Adapts Neumann KK104 and KK105 and Sennheiser capsules for the 5000 Series wireless with Shure style threads to the HH transmitter

**HHA is available from Ambient Recording dealers**

**Visit: [www.ambient.de](http://www.ambient.de)**

# Troubleshooting

## SYMPTOM

TRANSMITTER WILL NOT POWER ON

## POSSIBLE CAUSE

- 1) Batteries are inserted backwards.
- 2) Batteries are dead, or too low to be used.

HH MODULATION LEDs OFF

- 1) Audio Gain set too low.
- 2) Battery is inserted backwards. Check LCD for power indication.
- 3) Mic capsule is damaged or malfunctioning. Contact the factory for repair.

HH MODULATION LEDs GOOD BUT NO SOUND

- 1) Talkback function is engaged (release multi-function button). See p. 11.
- 2) Receiver on wrong frequency or wrong band.
- 3) Receiver connected incorrectly to sound system.
- 4) Transmitter in standby mode.

RECEIVER RF INDICATOR OFF

- 1) Transmitter not turned on.
- 2) Transmitter is in "standby" (non-transmitting) mode. Check the LCD for the antenna/transmission icon status.
- 3) Batteries are dead or installed backwards.
- 4) Receiver antenna missing, defective or improperly positioned.
- 5) Transmitter and receiver not on same frequency band. Check labels on transmitter and receiver to be sure they are operating on the same frequency band.
- 6) Make sure the transmitter and receiver frequency settings are in agreement.
- 7) Operating range is too great.
- 8) Receiver antenna missing, incorrect frequency or disconnected.

NO SOUND BUT RECEIVER AUDIO LEVEL METER INDICATES SOUND

- 1) Receiver audio is muted. (Unmute receiver.)
- 2) Receiver audio output levels set too low.
- 3) Receiver audio output is disconnected or cable defective or mis-wired.
- 4) Sound system or recorder input level is turned down.

DISTORTED SOUND

- 1) Transmitter Audio Gain set too high. Speak or sing into the transmitter and check the Audio Level LEDs, Audio Level bar graph in the transmitter LCD and corresponding indicators on the receiver.
- 2) Receiver output level may be too high for the sound system or recorder input.
- 3) Excessive wind noise or "breath pops." Microphone may require an additional wind screen.
- 4) Transmitter frequency setting is not correct (when used with non-Digital Hybrid receiver).
- 5) Compatibility Mode mismatch between transmitter and receiver.
- 6) Mic capsule damaged or defective

HISS AND NOISE -- AUDIBLE DROPOUTS

- 1) Transmitter Audio Gain set too low. See page 10 for proper audio gain setting.
- 2) Receiver antenna missing, defective or obstructed.
- 3) Operating range too great.
- 4) Interference may be present. Turn transmitter off and observe the RF level indicator on the receiver. Change frequency if necessary.
- 5) Return attenuator control back to default setting of "F", then readjust audio gain per instructions on page 10

EXCESSIVE FEEDBACK

- 1) Transmitter Audio Gain set too high. Check level adjustment, reduce receiver output level, or both.
- 2) Microphone too close to speaker system.
- 3) Move microphone closer to the user's mouth and lower the sound system volume.

# Specifications

## Operating frequencies: †

Band A1:	470.100 - 537.575
Band B1:	537.600 - 614.375
Band C1:	614.400 - 691.175

Channel Step Size:	
Normal Tuning mode:	100 kHz
Fine Tuning mode:	25 kHz
RF Power output:	Selectable at 50 or 100 mW
Pilot tone:	25 to 32 kHz frequency; 5 kHz deviation (Hybrid, IFB, 200 Series, Mode 6)
Frequency stability:	± 0.002%
Deviation:	± 75 kHz max. (Digital Hybrid mode)
Spurious radiation:	90 dB below carrier
Operating temperature range:	-20° C to +50° C
Input compressor:	Dual envelope compressor, >30 dB range
Audio Gain range:	0 to 45 dB; menu selectable
Modulation indicators:	Dual bicolor LEDs indicate modulation of -20, -10, 0 and +10 dB referenced to full modulation, LCD bar-graph indicator
Frequency response	40 Hz to 20 kHz (+/- 1dB)
Low frequency roll-off:	-3 dB selectable @35, 50, 70, 100, 125 Hz, 36 dB/octave (varies slightly w/ selection)
Controls:	
External:	Programmable mute/talkback button
Internal control panel:	Power, Side Button Setup, MENU/SEL, BACK and Up/Down arrow buttons for menu item selection and settings.
Battery:	(2) AA with polarity protection and battery ejection lever
Battery Life:	5.5 hours (Duracell Quantum alkaline)
Battery Status Indication:	Transmitted to Lectrosonics Digital Hybrid and 200 Series receivers
Capsule Interface:	1.25 in. diameter x 28 thread pitch
Capsule Power available:	5V, 25 mA max
Input impedance:	1000 Ohms
Weight:	12.1 oz. with batteries and HHC capsule
Dimensions:	9.5" long x 1.97" diameter at largest point with HHC capsule attached
Emission Designator:	180KF3E

*Specifications subject to change without notice.*

† Not all frequency bands are available in all countries. Consult your local representative or contact Lectrosonics for more information.

**FCC Compliance:**

This device complies with FCC radiation exposure limits as set forth for an uncontrolled environment. This device should be installed and operated so that its antenna(s) are not co-located or operating in conjunction with any other antenna or transmitter.

**Notice to the End User:**

The normal condition of using this device is to keep the hand at least 20mm away from the base of the microphone.

**Industry Canada Compliance:**

This device operates on a no-protection no-interference basis. Should the user seek to obtain protection from other radio services operating in the same TV bands, a radio license is required. Please consult Industry Canada's document CPC-2-1-28, Optional Licensing for Low-Power Radio Apparatus in the TV Bands, for details.

This device complies with Industry Canada license-exempt RSS standard(s). Operation is subject to the following two conditions:

1. This device may not cause harmful interference;
2. This device must accept any interference received, including interference that may cause undesired operation of the device.

Cet appareil est conforme à Industrie Canada une licence standard RSS exonérés (s). Son fonctionnement est soumis aux deux conditions suivantes:

1. Cet appareil ne doit pas provoquer d'interférences
2. Cet appareil doit accepter toute interférence reçue, y compris les interférences pouvant provoquer un fonctionnement indésirable de l'appareil

## Service and Repair

If your system malfunctions, you should attempt to correct or isolate the trouble before concluding that the equipment needs repair. Make sure you have followed the setup procedure and operating instructions. Check the interconnecting cables and then go through the **Troubleshooting** section in this manual.

We strongly recommend that you **do not** try to repair the equipment yourself and **do not** have the local repair shop attempt anything other than the simplest repair. If the repair is more complicated than a broken wire or loose connection, send the unit to the factory for repair and service. Don't attempt to adjust any controls inside the units. Once set at the factory, the various controls and trimmers do not drift with age or vibration and never require readjustment. **There are no adjustments inside that will make a malfunctioning unit start working.**

LECTROSONICS' Service Department is equipped and staffed to quickly repair your equipment. In-warranty repairs are made at no charge in accordance with the terms of the warranty. Out-of-warranty repairs are charged at a modest flat rate plus parts and shipping. Since it takes almost as much time and effort to determine what is wrong as it does to make the repair, there is a charge for an exact quotation. We will be happy to quote approximate charges by phone for out-of-warranty repairs.

## Returning Units for Repair

For timely service, please follow the steps below:

- A. DO NOT return equipment to the factory for repair without first contacting us by letter or by phone. We need to know the nature of the problem, the model number and the serial number of the equipment. We also need a phone number where you can be reached 8 A.M. to 4 P.M. (U.S. Mountain Standard Time).
- B. After receiving your request, we will issue you a return authorization number (R.A.). This number will help speed your repair through our receiving and repair departments. The return authorization number must be clearly shown on the **outside** of the shipping container.
- C. Pack the equipment carefully and ship to us, shipping costs prepaid. If necessary, we can provide you with the proper packing materials. UPS is usually the best way to ship the units. Heavy units should be "double-boxed" for safe transport.
- D. We also strongly recommend that you insure the equipment, since we cannot be responsible for loss of or damage to equipment that you ship. Of course, we insure the equipment when we ship it back to you.

### Mailing address:

Lectrosonics, Inc.  
PO Box 15900  
Rio Rancho, NM 87174  
USA

### Shipping address:

Lectrosonics, Inc.  
581 Laser Rd.  
Rio Rancho, NM 87124  
USA

### Telephone:

(505) 892-4501  
(800) 821-1121 Toll-free  
(505) 892-6243 Fax

### Web:

[www.lectrosonics.com](http://www.lectrosonics.com)

### E-mail:

[sales@lectrosonics.com](mailto:sales@lectrosonics.com)

### Lectrosonics Canada:

#### Mailing Address:

720 Spadina Avenue,  
Suite 600  
Toronto, Ontario M5S 2T9

#### Telephone:

(416) 596-2202  
(877) 753-2876 Toll-free  
(877-7LECTRO)  
(416) 596-6648 Fax

#### E-mail:

Sales: [colinb@lectrosonics.com](mailto:colinb@lectrosonics.com)  
Service: [joeb@lectrosonics.com](mailto:joeb@lectrosonics.com)





## LIMITED ONE YEAR WARRANTY

The equipment is warranted for one year from date of purchase against defects in materials or workmanship provided it was purchased from an authorized dealer. This warranty does not cover equipment which has been abused or damaged by careless handling or shipping. This warranty does not apply to used or demonstrator equipment.

Should any defect develop, Lectrosonics, Inc. will, at our option, repair or replace any defective parts without charge for either parts or labor. If Lectrosonics, Inc. cannot correct the defect in your equipment, it will be replaced at no charge with a similar new item. Lectrosonics, Inc. will pay for the cost of returning your equipment to you.

This warranty applies only to items returned to Lectrosonics, Inc. or an authorized dealer, shipping costs prepaid, within one year from the date of purchase.

This Limited Warranty is governed by the laws of the State of New Mexico. It states the entire liability of Lectrosonics Inc. and the entire remedy of the purchaser for any breach of warranty as outlined above. NEITHER LECTROSONICS, INC. NOR ANYONE INVOLVED IN THE PRODUCTION OR DELIVERY OF THE EQUIPMENT SHALL BE LIABLE FOR ANY INDIRECT, SPECIAL, PUNITIVE, CONSEQUENTIAL, OR INCIDENTAL DAMAGES ARISING OUT OF THE USE OR INABILITY TO USE THIS EQUIPMENT EVEN IF LECTROSONICS, INC. HAS BEEN ADVISED OF THE POSSIBILITY OF SUCH DAMAGES. IN NO EVENT SHALL THE LIABILITY OF LECTROSONICS, INC. EXCEED THE PURCHASE PRICE OF ANY DEFECTIVE EQUIPMENT.

This warranty gives you specific legal rights. You may have additional legal rights which vary from state to state.

