

T5 Series

conference tables

designed to properly support AV technology
for ultimate system reliability

features:

- Each T5 solution includes a table top, support pedestals and a Tech Kit. The Tech kit is optimized for the designated table size and is comprised of the critical infrastructure that supports reliable AV systems:
 - Patent-pending swing-out pedestal rack can be located in the table pedestal of choice. Innovative flexibility for up to 3 RU of sideways rackmounting, small device mounting or a combination of the two. Includes three tool-free Lever Lock™ plates for mounting small devices
 - Wiremold InteGreat™ Table Boxes in black or silver with 2 retracting HDMI cables and 2 AC outlets for power and connectivity at the surface. Table boxes & cable retractors are concealed by the table's pedestal
 - Included power distribution
- Styles and finishes correspond with Pre-configured C5 Series Credenzas, providing cohesive furniture designs for any meeting space
 - Sota style with rectangular shape and self-edge, available in HPL and Veneer finish
 - Klasik style with boat shape and ogee-shaped edge, available in Veneer finish
- 3 sizes available: 8' (seats up to 8 users), 12' (seats up to 12 users), 16' (seats up to 16 users)
- Pedestal locks to secure equipment within



specifications:

T5 Series Conference Room Table shall be Middle Atlantic Products model # T5_____ (refer to chart). T5 Series Conference Room Table shall have a ___ (Klasik, Sota, refer to drawings) style have a ___ (HPL, Veneer, refer to chart) finish, in a ___ (refer to chart for color options). T5 Series Conference Room Table shall be ___"H x ___"W" x ___" D (refer to chart). T5 Series Conference Room Table shall include a cable management trough between each pedestal, with a useable area of 2.6" H x 8.5" W. T5 Series Conference Room Table shall include ___ (2,3 refer to chart) pedestals with lockable access door. T5 Series Conference Room Table shall include 3qty tool free Lever Lock mounting plates. T5 Series Conference Room Table shall require 1 qty T5-TECHKIT ___ (refer to chart) that shall include ___ (2,3) qty Table boxes in ___ (black, silver), ___ (1,2) qty 8 outlet power strip with ___ (72", 144") removable IEC cord, ___ qty (4, 6) HDMI retractors, and 1qty pedestal mounted swing out 3 rackspace 10-32 threaded rack kit. T5 Series Conference Room Table shall comply with the requirements of RoHS EU Directive 2011/65/EU. T5 Series Conference Room Table frame shall be warrantied to be free from defects in material or workmanship under normal use and conditions for a period of 7 years.

related products:

- Table Pedestal Rack shall be T5-RACK-KIT
- Lever Lock Kit shall be T5-LLOCKBKT-KIT
- T5 Series DC Fan Kit shall be T5-DCFANKIT-1

what **great systems** are built on.™

A brand of **legrand**

Middle Atlantic Products

middleatlantic.com | middleatlantic.ca

96-01245 / rev - / 5-12-17

T5 Series Conference Tables

basic dimensions

KLASIK VENEER	SIZE	PEDESTAL QTY.	TROUGH 37.5 [953]	TROUGH 61.5 [1562]	TABLETOP PIECE
T5KDD1BOVXXZP001	8'	2	1	NA	1
T5KFD1BOVXXZP001	12'	3	2	NA	2
T5KHD1BOVXXZP001	16'	3	NA	2	2

XX = 04 FOR SANDY MAPLE, 01 SCARLETT CHERRY, 07 FOR SEPIA WALNUT

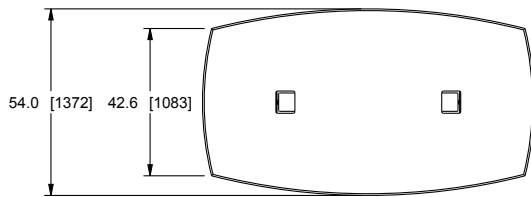

8' KLASIK
TOP VIEW

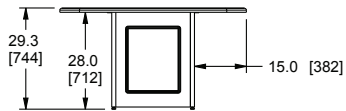

8' KLASIK
FRONT VIEW

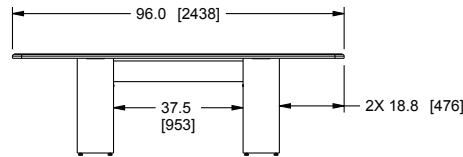

8' KLASIK
SIDE VIEW

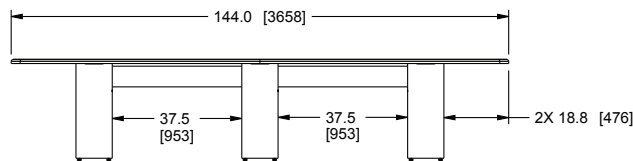

12' KLASIK
SIDE VIEW

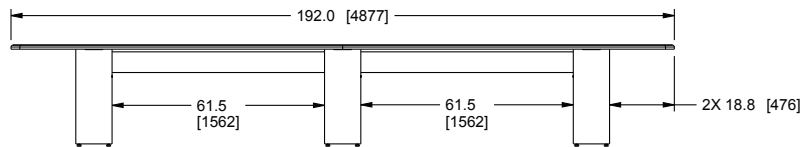

16' KLASIK
SIDE VIEW

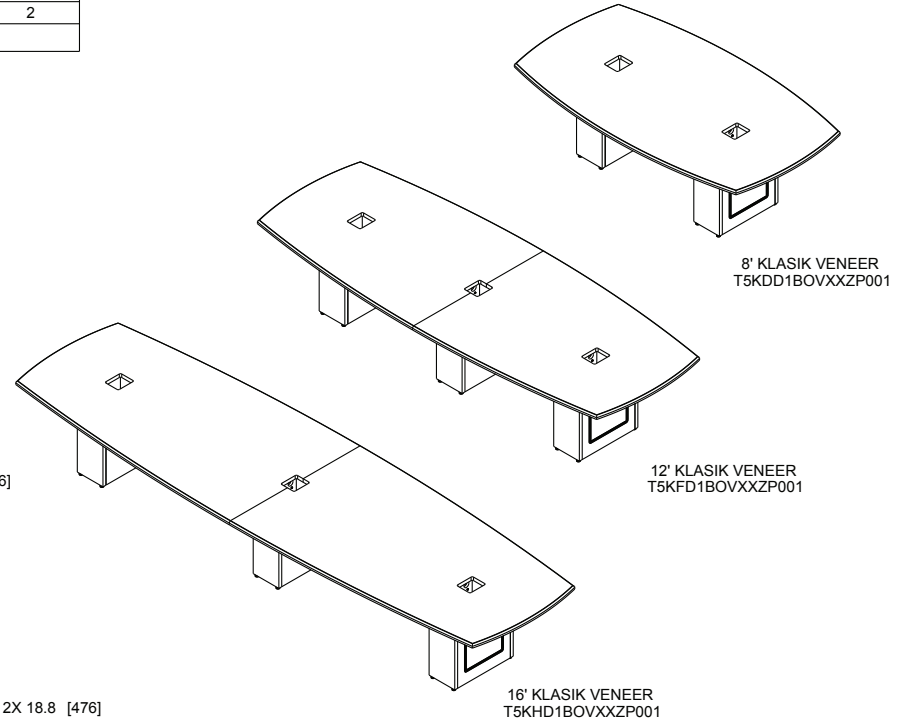

8' KLASIK VENEER
T5KDD1BOVXXZP001

12' KLASIK VENEER
T5KFD1BOVXXZP001

16' KLASIK VENEER
T5KHD1BOVXXZP001

NOTE:
DIMENSIONS SHOWN IN FORMAT IN [MM]

what great systems are built on.™

A brand of  Legrand



Middle Atlantic Products
middleatlantic.com | middleatlantic.ca

T5 Series Conference Tables

basic dimensions

SOTA HPL & VENEER	SIZE	PEDESTAL QTY.	TROUGH 37.5 [953]	TROUGH 61.5 [1562]	TABLETOP PIECE
T5SDC1RSYXXZP001	8'	2	1	NA	1
T5SFC1RSYXXZP001	12'	3	2	NA	2
T5SHC1RSYXXZP001	16'	3	NA	2	2

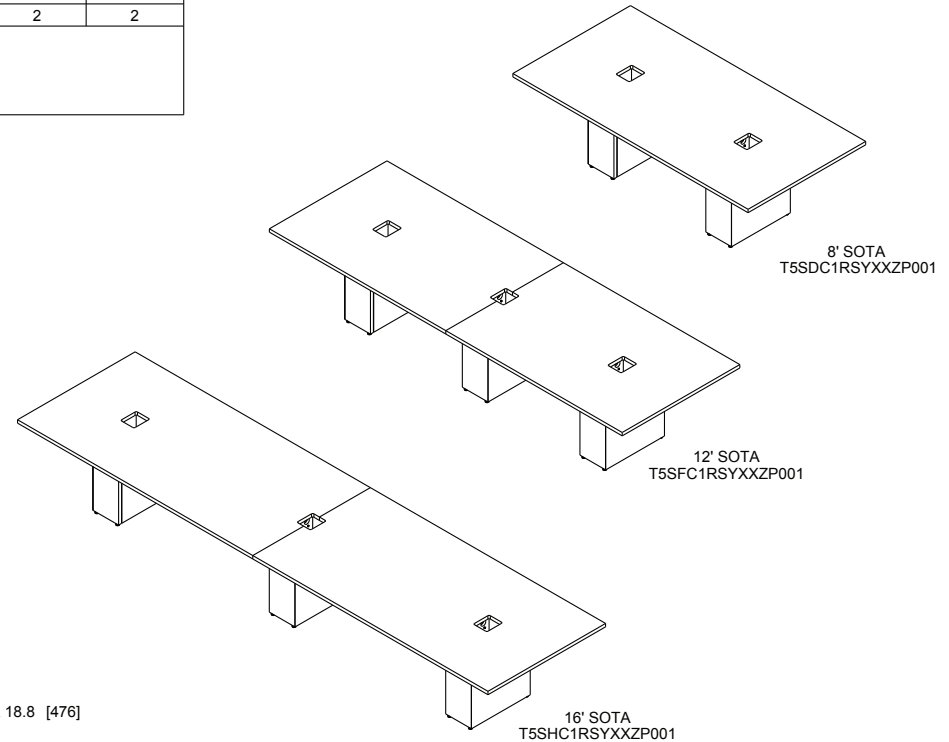
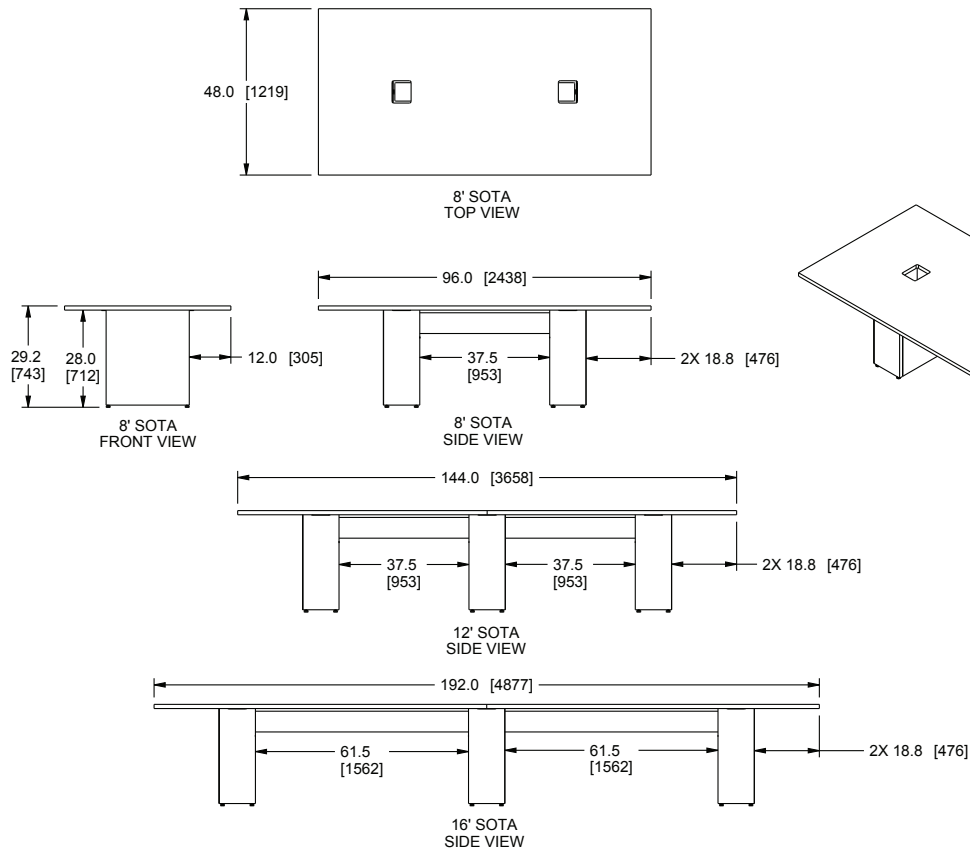
Y = H FOR HPL, V FOR VENEER
HPL FINISHES
XX = A0 FOR 5TH AVE ELM, A3 FOR ASIAN NIGHT, B3 FOR GLAMOUR CHERRY
VENEER FINISHES
XX = 04 FOR SANDY MAPLE, 01 FOR SCARLETT CHERRY, 07 FOR SEPIA WALNUT



NOTE:
DIMENSIONS SHOWN IN FORMAT IN [MM]

what great systems are built on.™

A brand of **legrand**

MA
Middle Atlantic Products
middleatlantic.com | middleatlantic.ca

T5 Series Conference Tables

basic dimensions

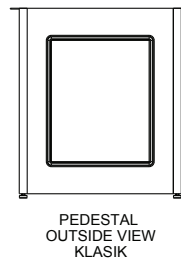
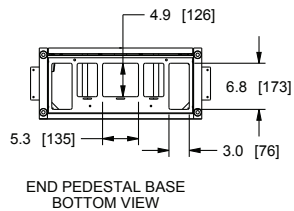
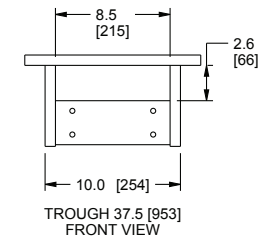
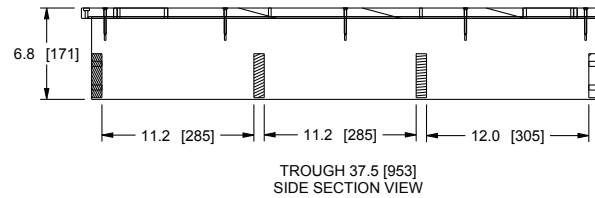
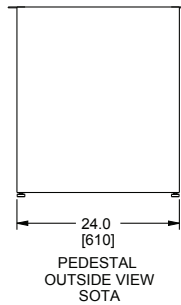
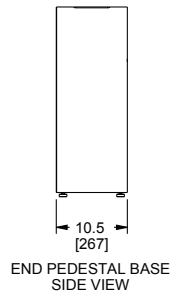
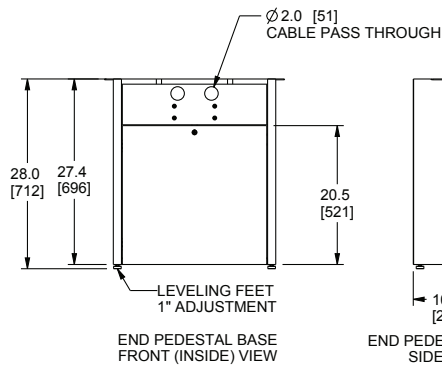
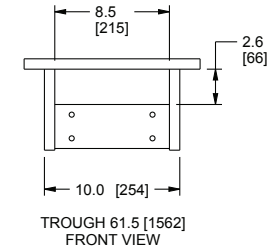
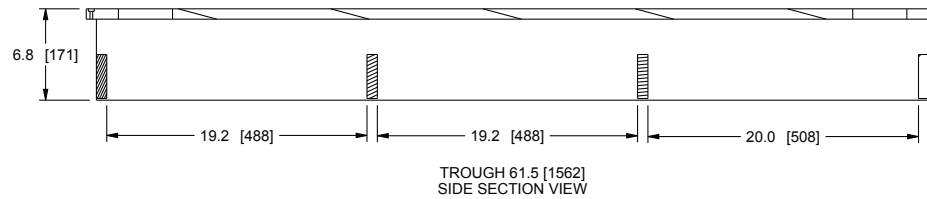
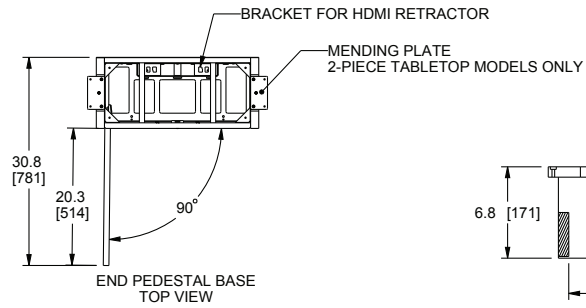

NOTE:
DIMENSIONS SHOWN IN FORMAT IN [MM]

what great systems are built on.™

A brand of **legrand**

Middle Atlantic Products
middleatlantic.com | middleatlantic.ca

T5 Series Conference Tables

basic dimensions

TECHKIT*	SIZE	TABLE BOX	8 OUTLET POWER STRIP, IEC	IEC 72"(6') SS CORD	IEC 144"(12') SS CORD	IEC 180"(15') SS CORD	HDMI RETRACTOR	T5-RACK-KIT
T5-TECHKIT8X	8'	2	1	1	NA	NA	4	1
T5-TECHKIT12X	12'	3	2	1	1	NA	6	1
T5-TECHKIT16X	16'	3	2	1	NA	1	6	1

X = S FOR SILVER, B FOR BLACK
*MUST ORDER 1 QTY. WITH EACH TABLE

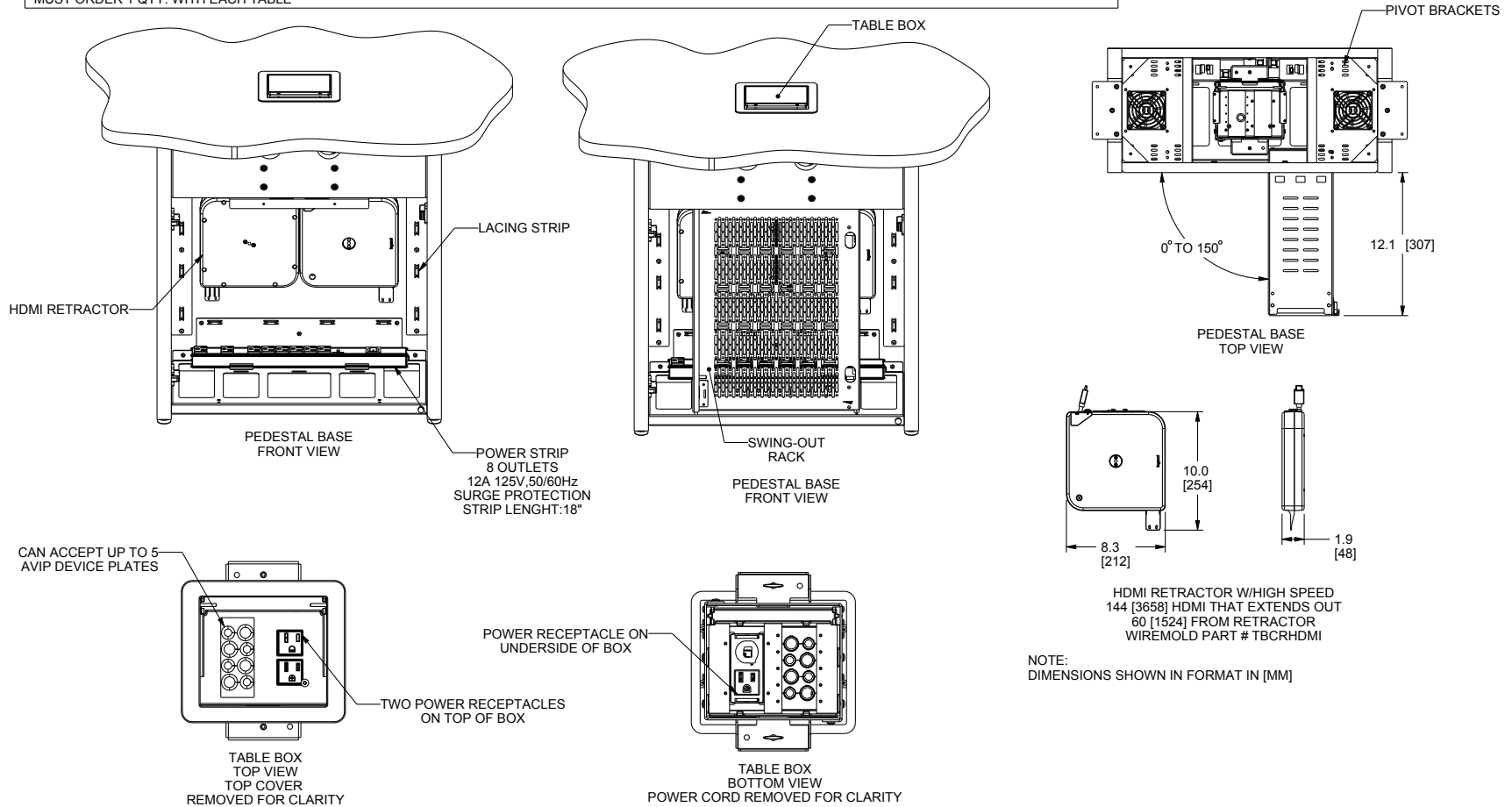

what great systems are built on.™

A brand of **legrand**

MA
Middle Atlantic Products
middleatlantic.com | middleatlantic.ca

T5 Series Conference Tables

basic dimensions

	SWING-OUT RACK QTY.	FACE AFTER PLATE QTY.	2" LEVER LOCK PLATE QTY.	10" LEVER LOCK PLATE QTY.	LEVER LOCK ADAPTER BRACKET QTY.
T5-RACK-KIT	1	1	2	1	2
T5-LLOCKBKT-KIT	NA	1	2	1	2

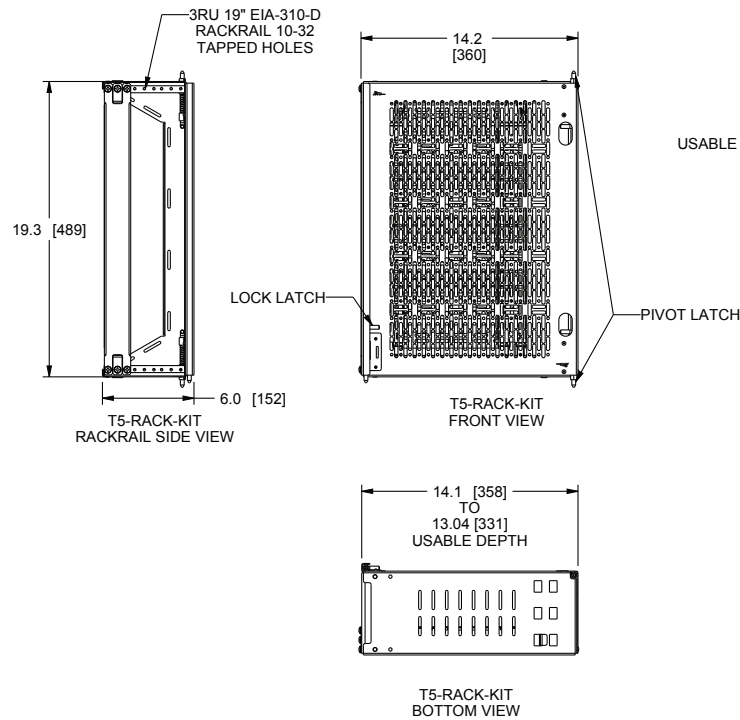

RACK
USABLE AREA = 16.47 [418] X 14.40 [366]
USABLE HEIGHT = 5.35 [136]

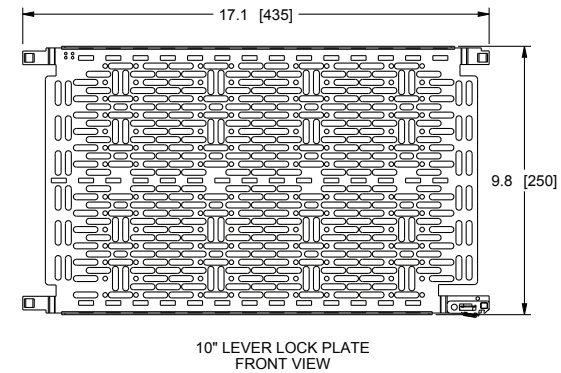
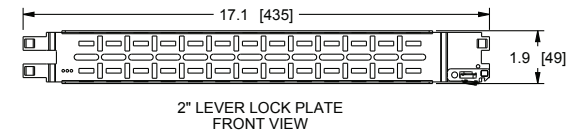
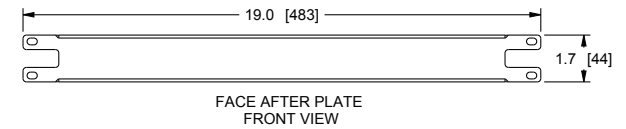
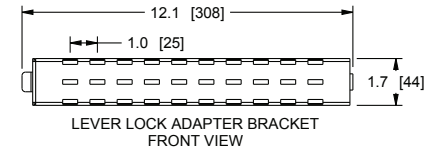
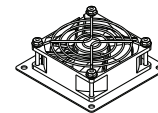
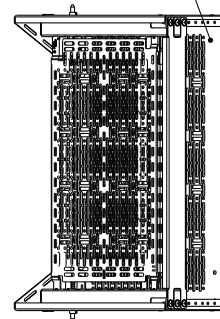

NOTE:
DIMENSIONS SHOWN IN FORMAT IN [MM]