

C83EN1572

E **ENGLISH**

dp0

Quattro

USER'S MANUAL

Thank you for purchasing the Sigma dp0 Quattro Digital Compact Camera

You will get the greatest performance and enjoyment from your new dp0 Quattro camera's features by reading this instruction manual carefully before operating it. Enjoy your new Sigma camera!

- Please keep this instruction booklet handy for future reference. Doing so will allow you to understand and take advantage of the camera's unique features at any time.
- The warranty of this product is one year from the date of purchase. Warranty terms and warranty card are on a separate sheet, attached. Please refer to these materials for details.

NOTES ON COPYRIGHT

This camera is intended only for personal use and should never be used in a way that infringes upon or contravenes international or domestic copyright laws and regulations. In addition, although it is intended purely for personal use, some restrictions may be applied to the photographing of demonstrations, performances, shows, exhibitions, or commercial properties, etc. Copyright or other legal rights should not be contravened.

- FOVEON is a registered trademark of Foveon, Inc. X3, and the X3 Logos are trademarks of Foveon, Inc.
- IBM PC/AT series computer is a trademark or registered trademark of International Business Machines Corporation (IBM) in the U.S.A.
- Microsoft and Windows are either registered trademarks or trademarks of Microsoft Corporation in the United States and/or other countries.
- Macintosh and MAC OS are registered trademarks or trademarks of Apple Inc. in the U.S.A. and /or other countries.
- Adobe and Photoshop are trademarks of Adobe Systems Incorporated.
- Eye-Fi, the Eye-Fi logo and Eye-Fi connected are trademarks of Eye-Fi, Inc.
- All other company or product names used in documents are trademarks or registered trademarks of their respective holders.
- Element font designed by Ricoh CO., Ltd. is used for the display of the menu window of this camera.



Disposal of Electric and Electronic Equipment in Private Households
Disposal of used Electrical & Electronic Equipment (Applicable in the European Union and other European countries with separate collection systems)

This symbol indicates that this product shall not be treated as household waste. Instead it shall be collected separately for the recycling of electrical and electronic equipment. If the new products are purchased, this product might be handed over to the distributor or the collection system of waste electrical and electronic equipment eventually. By ensuring this product is disposed of correctly, you will help prevent potential negative consequences for the environment and human health, which could otherwise be caused by inappropriate waste handling of this product or components of this product. If this product is disposed illegally, it might cause a possibility of penalties. For more detailed information about recycling of this product, please contact your local city office, your household waste disposal service or the shop where you have purchased the product.

PACKAGE CONTENTS / ACCESSORIES

Please make sure that following standard accessories are included with your camera. If any of them is missing, contact the retailer from which you purchased your camera immediately.

1. Camera Body (dp0 Quattro)
2. Lens Cap (on the camera)
3. Hot Shoe Cover (on the camera)
4. Lens Hood
5. Strap
6. Battery Case
7. Li-ion Battery BP-51 (2 pieces)
8. Battery Charger BC-51
9. Battery Charger Cable
10. USB Cable
11. Instruction Manual
12. Limited Warranty
13. Warranty Sticker
14. Battery Marking Sticker

● No memory card is included with this camera. Please purchase this separately.

TABLE OF CONTENTS

| | |
|--|-----------|
| PACKAGE CONTENTS / ACCESSORIES | 3 |
| TABLE OF CONTENTS | 4 |
| SAFETY PRECAUTIONS | 7 |
| HANDLING PRECAUTIONS | 10 |
| SD MEMORY CARD | 11 |
| DESCRIPTION OF THE PARTS | 12 |
| COLOR LCD MONITOR INDICATION..... | 14 |
| BASIC OPERATION AND QUICK REFERENCE | 15 |
| PREPARATION | 18 |
| ATTACHING THE CARRY STRAP | 19 |
| LENS CAP | 19 |
| LENS HOOD | 20 |
| LOADING THE BATTERY | 21 |
| TO CHARGE THE BATTERY..... | 21 |
| LOADING THE BATTERY..... | 23 |
| SETTING THE LANGUAGE | 25 |
| SETTING THE TIME AND DATE | 26 |
| CAMERA SET-UP MENU | 28 |
| QUICK SET MENU | 35 |
| CHANGING THE COLOR LCD MONITOR DISPLAY | 36 |
| INSERTING AND REMOVING THE CARD | 38 |
| FORMATTING THE CARD | 40 |
| SHUTTER BUTTON | 41 |
| QUICK PREVIEW..... | 42 |
| BASIC OPERATION | 43 |
| SELECTING THE EXPOSURE MODE..... | 44 |
| SELECTING THE EXPOSURE MODE | 44 |
| P PROGRAM AE | 45 |
| A APERTURE PRIORITY AE | 46 |
| S SHUTTER SPEED PRIORITY AE..... | 47 |
| M MANUAL EXPOSURE | 48 |
| FOCUSING..... | 50 |
| FOCUS MODE..... | 50 |
| HOW TO USE AUTOFOCUS..... | 50 |

| | |
|--|-----------|
| SETTING THE FOCUS FRAME..... | 51 |
| FOCUS LOCK..... | 52 |
| AF+MF MODE..... | 52 |
| AF LIMIT MODE..... | 53 |
| FACE DETECTION AF MODE..... | 55 |
| SPEED PRIORITY AF..... | 56 |
| HALF-PRESSED AF-ON..... | 56 |
| MANUAL FOCUS..... | 57 |
| OPERATION OF THE DRIVE MODE..... | 59 |
| SINGLE FRAME SHOOTING..... | 59 |
| CONTINUOUS SHOOTING..... | 59 |
| SELF TIMER..... | 60 |
| INTERVAL TIMER..... | 61 |
| ADVANCED OPERATION..... | 63 |
| SETTING THE WHITE BALANCE (WB)..... | 64 |
| SETTING THE SENSITIVITY (ISO EQUIVALENCY)..... | 69 |
| IMAGE FILE SETTING..... | 71 |
| SELECTING THE METERING MODE..... | 75 |
| AE LOCK..... | 76 |
| EXPOSURE COMPENSATION..... | 78 |
| AUTO BRACKETING..... | 78 |
| COLOR MODE..... | 81 |
| OVEREXPOSURE CORRECTION..... | 84 |
| TONE CONTROL..... | 85 |
| COLOR SPACE..... | 85 |
| AUTO ROTATE..... | 86 |
| CUSTOM MODE..... | 86 |
| USING THE EXTERNAL FLASH..... | 88 |
| TTL AUTO FLASH..... | 89 |
| SETTING THE FLASH MODE..... | 90 |
| FLASH EXPOSURE COMPENSATION..... | 91 |
| USING Eye-Fi CARD (Eye-Fi Connected)..... | 92 |
| REVIEWING AND DELETING IMAGES..... | 95 |
| REVIEWING IMAGES..... | 96 |
| VIEWING ONE IMAGE AT A TIME..... | 97 |
| MAGNIFYING IMAGES (ZOOMED-IN VIEW)..... | 98 |

| | |
|--|------------|
| VIEWING NINE IMAGES AT A TIME (CONTACT SHEET VIEW) | 99 |
| VIEWING IMAGE INFORMATION | 100 |
| HISTOGRAM | 102 |
| DELETING FILES | 103 |
| DELETE A FILE WITH THE DELETE BUTTON | 103 |
| DELETE FILES FROM THE DELETE MENU | 104 |
| OTHER REVIEWING FEATURES | 105 |
| LOCKING FILES | 106 |
| MARKING IMAGES | 108 |
| ROTATING IMAGES | 110 |
| EXPOSURE WARNING | 112 |
| OK BUTTON SHORTCUT | 113 |
| RECORDING SOUND MEMO | 114 |
| SHOWING A SLIDESHOW | 116 |
| DPOF (DIGITAL PRINT ORDER FORMAT) | 118 |
| DEVELOPING RAW DATA INSIDE THE CAMERA | 119 |
| CHANGING OTHER SETTINGS | 121 |
| FILE NUMBERING SYSTEM | 122 |
| TO CHANGE FILE NAMES | 123 |
| ATTACH COPYRIGHT INFORMATION | 124 |
| CUSTOMIZE THE DISPLAY OF LCD MONITOR | 126 |
| CUSTOMIZING THE DIAL | 129 |
| LCD OFF AND AUTO POWER OFF | 130 |
| ECO MODE | 131 |
| SOUND SETTINGS | 132 |
| RESET TO THE DEFAULTS | 133 |
| CONNECTING TO A COMPUTER | 134 |
| REFERENCE | 136 |
| OPTIONAL ACCESSORIES | 137 |
| USING A HOME POWER SUPPLY | 138 |
| MAINTENANCE | 140 |
| TROUBLESHOOTING | 141 |
| SPECIFICATIONS | 144 |

SAFETY PRECAUTIONS

To avoid causing damage or injury, please read this instruction manual carefully, before using the camera.

Please take special note of the following two cautionary symbols.











 **Warning !!** Using the product and disregarding this warning sign may cause serious injury or other dangerous results.

 **Caution !!** Using the product disregarding this caution sign may cause injury or damage.









 This symbol denotes a warning or point, where caution is required.

 This Symbol contains information regarding the actions that must be avoided.





WARNING (BATTERY)



-  Keep batteries in a safe place out of children's reach. If a battery is swallowed, call for emergency medical aid immediately.
-  Do not use any battery other than the designated battery types. Doing so may cause battery explosion, battery leakage, camera damage, injury or fire.
-  Do not use any battery other than that specified in this booklet. Otherwise, it might cause battery explosion, battery leakage, camera damage, injury or fire.
-  Avoid any shock, shake and drop. Ignoring this warning may cause battery explosion, or battery leakage, resulting in injury or fire.
-  Never disassemble, short circuit, heat, or put batteries into fire. Ignoring this warning may cause battery explosion, battery leakage, injury or fire.
-  Please only use charger with the dedicated battery. Charging other battery types causes battery explosion, battery leakage, camera damage, injury or fire.
-  If for some reason, the camera or batteries emit smoke, or if overheating or the smell of burning is detected, remove the batteries, taking care to avoid being burned. Take the camera to the retailer where you bought it, or to an authorized Sigma service station.
-  Please follow all guidelines, rules and regulations of your community regarding the disposal of batteries. If you do not use the camera for a long period of time, remove the battery.
-  Do not use any AC adapter other than the one provided with your camera. Using other brands may cause electrical shock and fire
-  Keep batteries in a safe place out of children's reach. If a battery is swallowed, call for emergency medical aid immediately.

⚠ WARNING (BATTERY CHARGER AND AC ADAPTER)



-  The battery charger is for indoor use only. Do not store the charger in humid or dusty locations.
-  Use it within the 0°C - 40°C temperature range only.
-  The AC Adapter is designed for use with this product only. Do not use it with any other appliance. Doing so may cause overheating, fire, electric shock or injury.
-  If the adapter is emitting smoke, generating a strange odor or making an abnormal noise, while in use, disconnect the power plug from the outlet immediately. Otherwise, fire or electric shock may result.
-  If water or a foreign object gets into the adapter, unplug from the AC outlet immediately. It could cause fire or electric shock.
-  Do not attempt to modify or disassemble this product. Doing so can cause fire or electric shock.
-  Do not place any heavy objects on the power cord, or pull it, bend it unduly, or heat it. It could damage the cord, and could cause fire or electric shock.
-  Do not use this product with AC voltage other than the specified power supply voltage AC110V - 240V (120V in U.S.A. and CANADA). Doing so could cause fire or electric shock.
-  Use a safety approved AC power cord as is specified by each country.

⚠ WARNING (CAMERA)





-  Never use your camera in an environment where flammable or burnable, gas, liquids or chemicals, such as Propane, Gasoline, etc., are present.
-  Keep the camera in a safe place that children cannot reach. Playing with the camera strap around one's neck can cause strangulation.
-  Do not disassemble the camera; Doing so can cause electric shocks and burns.
-  Do not touch internal parts of the camera that become exposed as a result of damage, it could cause fire or electric shock. Remove the batteries and contact an authorized Sigma service station.
-  Keep the camera away from moisture or water. If you drop your camera/lens in water, please contact the retailer where you purchased the camera, or a service station immediately. If you use the camera with this condition it can cause electric shock or fire.

-  Prevent water, or metallic and other conductive objects from coming into contact with the terminals of the camera body. This can result in electric shock, overheating and fire.
-  Do not fire the flash close to eyes, otherwise the bright light could damage the eye. Keep at least 1m/3feet distance between the face and the camera when taking a picture with flash.
-  Do not cover the flash with your finger or hand, it can cause skin burn.

 **CAUTION (BATTERY CHARGER AND AC ADAPTER)**

-  Do not pull the Battery Charger or the AC power cord, when disconnecting the AC adapter from the AC outlet. It could cause fire or electric shock due to damaged cord. Always take hold of the molded AC plug, when unplugging it from the outlet.
-  Do not cover the Battery Charger or the AC adapter with cloth, cushions, etc. It could cause excessive heat, deform the case, and cause fire.
-  When Battery Charger is not used unplug it from the outlet.

 **CAUTION (CAMERA)**

-  Do not leave the camera without the lens cap in place. Light entering through the lens for long periods of time could cause damage to the camera.
-  Please do not carry your camera while a tripod is attached, as this could result in injury or a fall.
-  Please do not grasp the camera with wet hand, as it might cause electric shock
-  Do not leave the camera in a hot place or in a car parked in the sun. If the camera becomes hot, it might cause burns to the skin.
-  If the liquid crystal display (LCD) monitor becomes damaged, be careful of the fragments of glass, which can cause injury. If the liquid inside the LCD monitor leaks out, and you are faced with the following situations, please do as follows.
 - If the liquid adheres to clothes or the skin, wash it away with soap immediately.
 - If the liquid enters the eye, flush the affected eye with clean water immediately for 15 minutes, and seek medical assistance.
 - If the liquid is swallowed, drink a large quantity of water, induce vomiting and seek medical assistance.

HANDLING PRECAUTIONS

Please read this section before using the camera.

Study and familiarize yourself with the functions of your camera before using it. No compensation or guarantee is provided for unsatisfactory pictures or loss of profit, etc.

Carry spare batteries when you use the camera in a cold environment, on a field trip, or when taking many pictures at one time.

ENVIRONMENT

- Your camera is a precision instrument. Do not drop it or subject it to physical shock.
- This camera is not waterproof, and cannot be used underwater. Wipe off any water droplets with a dry cloth as soon as possible. If the camera gets really wet, promptly consult your nearest Sigma Service Center.
- Do not leave the camera in a dusty, hot, or highly humid environment for a long period of time.
- If the camera is moved from a cold place to a warm room, water droplets may appear on the camera. Please keep the camera in a bag until it is acclimatized to the ambient room temperature.
- The camera will work within a temperature range between 0°C/32°F and +40°C/104°F and humidity less than 85% (no condensation). However, in cold temperatures below 0°C, the power performance of the battery is reduced. Please carry a spare battery in these circumstances, and keep the batteries warm.
- Static electricity or magnetic fields may affect the operation of the camera. If such exposure occurs, please remove the battery from the camera and re-insert it, to reset the camera's microprocessors.

DURING PROLONGED USE

- Although there are cases where the surface of camera gets hot, this is not a malfunction.
- If you use the camera for an extended period of time, the camera may get hot and the warning mark (🔥) will be displayed. If the camera gets too heat, a warning message will be displayed and the camera will turn off automatically.

- If the camera turns off, please leave it switched off for more than ten minutes to lower its temperature.
- Image quality may lower when the camera gets hot. If the warning mark (🔥) is displayed, we recommend turning off the camera and wait until the temperature of the camera becomes lower.

SD MEMORY CARD

(sold separately)

The dp0 Quattro camera uses a SD memory card, SDHC memory card* and SDXC memory card*.



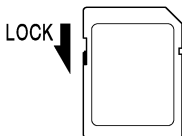

* UHS-1 standard memory card can also be used.

- In this instruction manual, SD memory card, SDHC memory card and SDXC memory card are referred to as the 'Card'.
- We recommend using the SDHC memory card or SDXC memory card to store images.
- SD memory card, SDHC memory card or SDXC memory card incorporate the write protection switch, which prevents writing or formatting the card accidentally. If the switch is placed in the 'LOCK' position, it is not possible to overwrite or erase your data accidentally.
- It is also possible to use an Eye-Fi card that has a Wi-Fi communication function. (P.92)
- Do not leave the card in direct sunlight or near a heating device.
- Avoid storing cards in environments of high temperature and humidity or where static electricity or electromagnetic fields may be generated.
- For proper usage of the card, please refer to their instruction manuals.
- The "Delete" feature of the Camera and PC may not delete the data in the memory card completely. Some data might still remain. If you wish to remove all data from card securely, please use third party software.

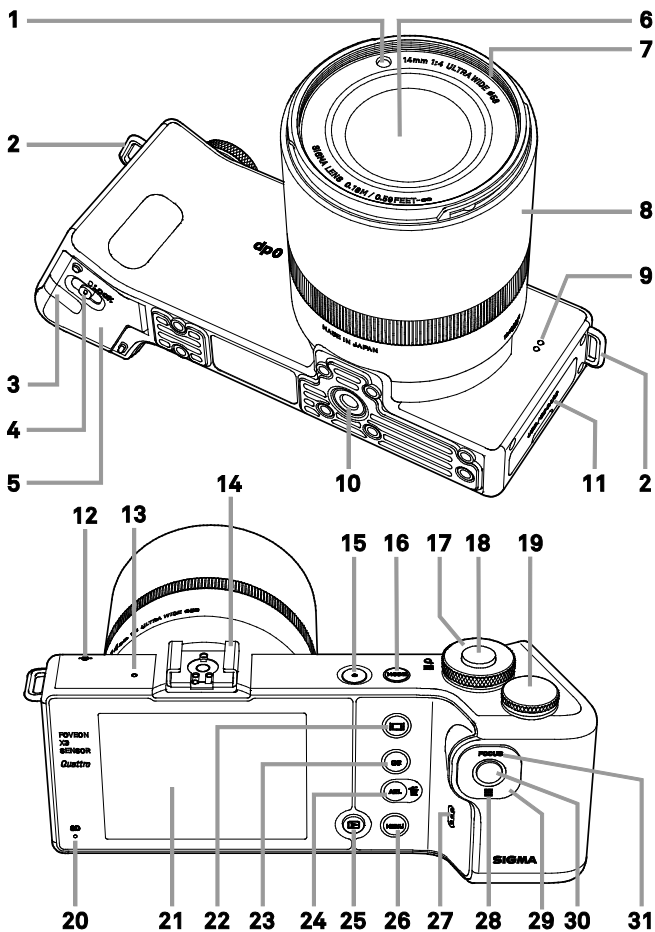





DESCRIPTION OF THE PARTS





| | | | |
|----|--------------------------|----|--|
| 1 | AF Auxiliary Light | 20 | Busy Lamp |
| 2 | Camera Strap Eyelet | 21 | Color LCD Monitor |
| 3 | DC Connector Cover | 22 |  (Display) Button |
| 4 | Release Lever | 23 | QS (Quick Set) Button |
| 5 | Battery Cover | 24 | AEL /  (AE Lock / Delete) Button |
| 6 | Lens | 25 |  (View) Button |
| 7 | Filter Attachment Thread | 26 | MENU (Menu) Button |
| 8 | Focus Ring | 27 | Speaker |
| 9 | Microphone | 28 |  (Focusing Point) Button |
| 10 | Tripod Socket | 29 | Selector |
| 11 | Card / USB Cover | 30 |  (OK) Button |
| 12 | Focal Plane Mark | 31 | FOCUS (Focus Mode) Button |
| 13 | Auto Focus Lamp | | |
| 14 | Hot Shoe | | |
| 15 | Power Switch | | |
| 16 | Mode Button | | |
| 17 | Front Dial | | |
| 18 | Shutter Button | | |
| 19 | Rear Dial | | |

SELECTOR (29)

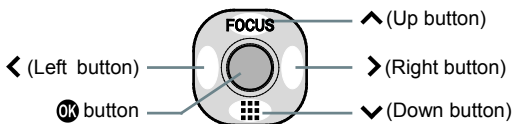
In this instruction manual, each position of selector is shown as ///.



- The buttons are used as follows: To operate Up and Down buttons: .
To operate Left and Right buttons: . To operate both Up and Down, and Left and Right buttons: .

COLOR LCD MONITOR INDICATION

Explanation of the icons displayed in still image shooting.

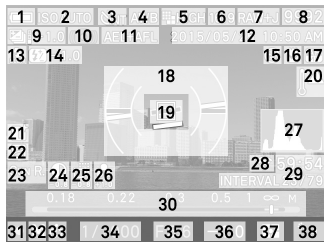
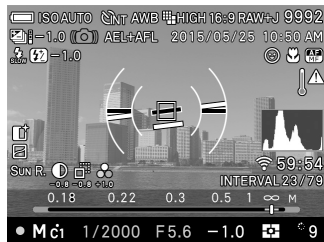

| | |
|----|-------------------------------------|
| 1 | Battery Level Indicator |
| 2 | ISO Sensitivity |
| 3 | Drive Mode |
| 4 | White Balance (Filtering Effect) |
| 5 | Image Size |
| 6 | Aspect Ratio |
| 7 | Image Quality |
| 8 | Number of shots remaining |
| 9 | Auto Bracket * |
| 10 | Camera Shake Warning |
| 11 | AE Lock * |
| 12 | Date / Time * |
| 13 | Flash Mode * |
| 14 | Flash Exposure Compensation value * |
| 15 | Face detection AF * |
| 16 | AF Limit Mode * |
| 17 | Focus Mode * |
| 18 | Electronic Level * |
| 19 | Focusing Frame |

| | |
|----|---|
| 20 | Temperature rise caution mark |
| 21 | Overexposure Correction * |
| 22 | Tone Control |
| 23 | Color Mode (Toning Effect) |
| 24 | Contrast * |
| 25 | Sharpness * |
| 26 | Saturation * |
| 27 | Histogram * |
| 28 | Eye-Fi Communication Icon * |
| 29 | Interval timer * |
| 30 | Scale Bar * |
| 31 | Focus Indicator |
| 32 | Exposure Mode |
| 33 | Custom Mode * |
| 34 | Shutter Speed |
| 35 | F Number |
| 36 | Exposure Compensation Value / Exposure Meter |
| 37 | Metering Mode |
| 38 | Number of shots remaining before memory buffer full |

* Displayed only during setting.



This mark shows that the image is being processed in camera after shooting. While this mark is displayed, it is not possible to operate the camera.



This mark shows that the camera is still shooting with a slow shutter speed.

BASIC OPERATION AND QUICK REFERENCE

The dp0 Quattro camera has many advanced features. This section, describes basic camera operation. You can find more details in later sections.

PREPARATION

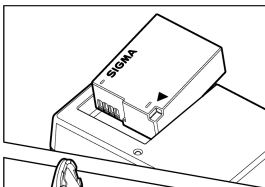

Charging the battery (P.21)

Charge the supplied lithium-ion battery with the provided battery charger.

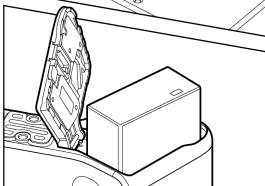

To insert the battery (P.23)



Set the language (P.25)

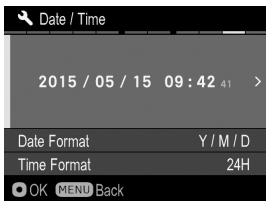

Set the date and time (P.26)

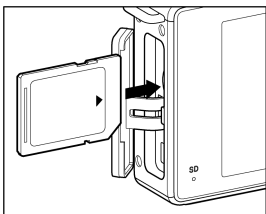

Loading the card (P.38)

TAKING THE PICTURE

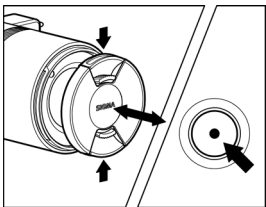

Turn the camera body on.

Remove the lens cap and press the Power switch.

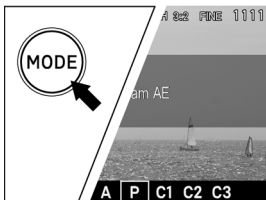

Select the exposure mode (P.44)

Press the 'Mode' button in **P** (Program AE) position



Focus (P.50)

Compose your image with the color LCD monitor and press the shutter button “half-way” to activate exposure metering and autofocus.

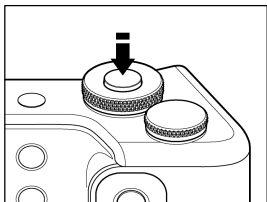
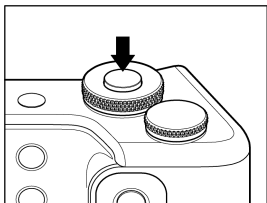

Take a picture

Fully press the shutter button to take the picture.



Review the image. (P.42)

The image is displayed for 2 seconds on the LCD monitor.

PREPARATION

This section describes necessary preparations before using the camera.

ATTACHING THE CARRY STRAP

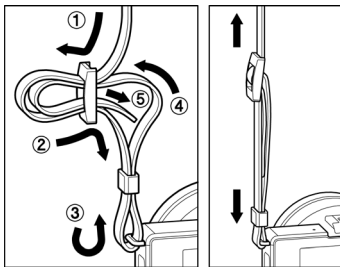

1

Undo the strap end.

2

Attach the carry strap as shown.

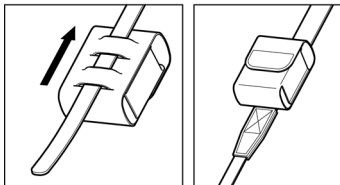

This strap can be attached to a battery case that is convenient for carrying a spare battery.

CAUTION !!

- The battery and battery case are not water-proof. Be sure not to get water on them.

LENS CAP

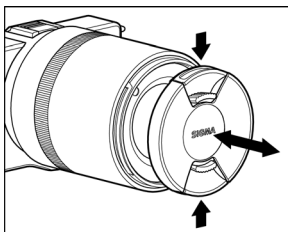

To preserve the lens, the lens cap is attached. If you do not use the camera, please keep the lens cap attached.

Attach or remove the lens cap as shown in the illustration.

LENS HOOD

While shooting images, it is recommended to attach the lens hood all the time as it blocks out extraneous light and reduces flare and ghosting.

HOW TO ATTACH

Turn the indicator on the lens hood upwards and then attached it to the tip of lens. Turn the lens hood to the right until it clicks into position.

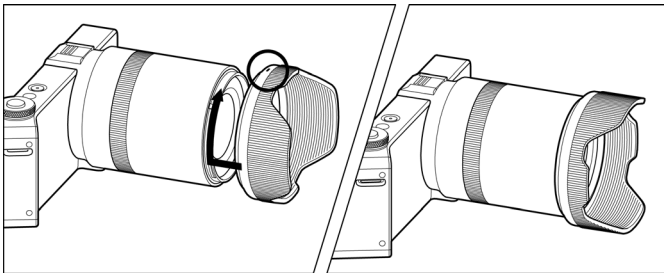

HOW TO DETACH

Rotate the lens hood anti-clockwise respectively.

- In order to place the lens and hood into the storage case, you must first remove the hood, then replace it on the lens in the reverse position.

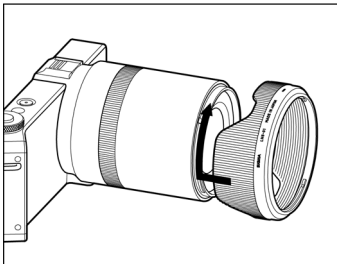

LOADING THE BATTERY

A lithium-ion battery, BP-51, is provided with the dp0 Quattro camera. Charge the battery before using the camera for the first time. Charge the battery by the supplied battery charger, BC-51, when the battery is empty.

TO CHARGE THE BATTERY

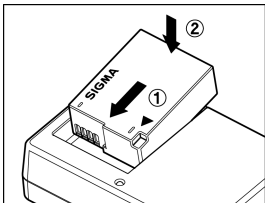

1

Attach the battery by sliding it in the direction of the arrow, as shown in the diagram.

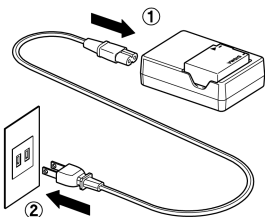

2

Connect the power cable to the charger and insert the plug into the wall outlet.

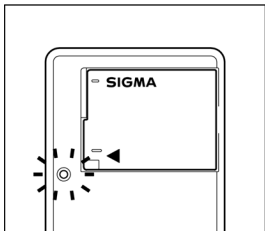

- The charge lamp will be green whilst the battery is charging
- It takes about 140 minutes to recharge the battery.
- Required time for recharging the battery depends on the ambient temperature and status of recharge level.

3

When the charge lamp goes out, charging is completed. Remove the battery from the charger and remove the charger from the wall outlet.

CAUTION !!

- We recommend charging the battery before using the camera again. If it is not used for several days, the battery performance decreases.
- If the number of possible images from one charge of the battery considerably decreases, it may indicate the end of battery's life. In this case, please purchase a new battery.

LOADING THE BATTERY

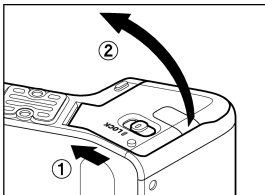

1

Slide the Release lever to the OPEN position, and open the Battery Cover as shown in the illustration.

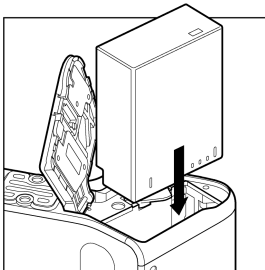

2

Insert the battery until it locks into place.

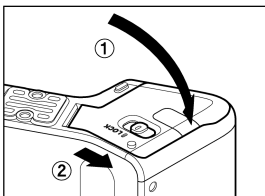



3

Close the Battery Cover and Slide the Release lever to the LOCK position as shown in the illustration.

CHECKING THE BATTERY STATUS

The battery icon, which shows the capacity of the battery, is shown on the left corner on the color LCD panel. Please take notice of the battery status before and when in use.



| | |
|--|---|
|  | The power of the battery is insufficient, replace or recharge the battery immediately. |
|  (Red) | The power of the battery is empty; the camera will no longer work. Replace or recharge the battery immediately. |
|  | The battery is working with the connected AC adapter. (P.138) |

TO REMOVE THE BATTERY

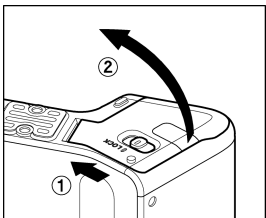

1

Slide the Release lever to the OPEN position, and open the Battery Cover as shown in the illustration.

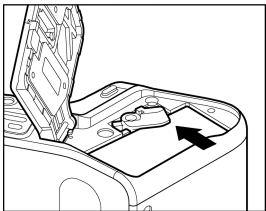

2

Eject the battery by sliding the battery compartment cover latch in the direction of the arrow, as shown in the illustration.

WARNING!!

- Busy Lamp is on or flashing, do not remove the battery or memory card. By doing so, it may result in data loss. This could also cause damage to the camera and/or memory card.

SETTING THE LANGUAGE

You should receive the dp0 Quattro camera pre-set to English, however, if necessary, you can change the camera language yourself.

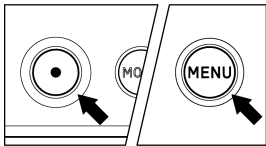

1
Turn the camera on.

2
Press the **MENU** button on the back of the camera to display the Camera Set-up Menu. (See P.28)

3
Select [**🔧 Camera Settings (4)**] by rotating the Front Dial or the Rear Dial.

4
Use the **◀▶** buttons to select [**Language/言語**].

5
Press the **OK** or **▶** button to open the language set-up page.

6
Use the **◀▶** buttons to select the desired language.

7
Press the **OK** button to apply the setting or the **MENU** button to return to the language set-up page without making any changes.



Selectable languages

| | |
|-----------------|---------------------|
| English | English (Default) |
| 日本語 | Japanese |
| Deutsch | German |
| Français | French |
| Español | Spanish |
| Italiano | Italian |
| 简体中文 | Simplified Chinese |
| 繁體中文 | Traditional Chinese |
| 한국어 | Korean |

| | |
|-------------------|------------|
| Русский | Russian |
| Nederlands | Dutch |
| Polski | Polish |
| Português | Portuguese |
| Dansk | Danish |
| Svenska | Swedish |
| Norsk | Norwegian |
| Suomi | Finnish |

SETTING THE TIME AND DATE

Please set the camera's internal clock, before using the camera for the first time or after extended periods of disuse.

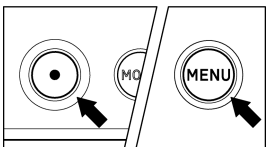

1

Turn the camera on.

2

Press the **MENU** button on the back of the camera to display the Camera Set-up Menu. (See P.28)

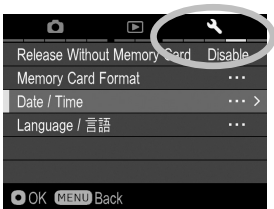

3

Select [**Camera Settings (4)**] by rotating the Front Dial or the Rear Dial.

4

Use the **◀▶** buttons to select [**Date/Time**].

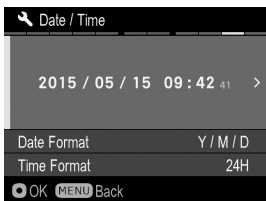

5

Press the **OK** or **>** button to open the date/time set-up page.

6

Press the **OK** button or the **>** button again to set the Date / Time.

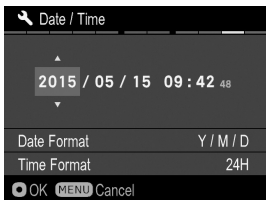

7

Press the **◀▶** button to select an item and change it by pressing the **◀▶** button.

8

Press the **OK** button to apply the setting or the **MENU** button to return to the date/time set-up page without making any changes.

CAUTION !!

- The camera's internal clock is powered by a capacitor that receives its charge from camera's battery. If the camera is without battery for an extended period of time, such as after prolonged storage, the internal clock will need to be reset.

TO CHANGE THE ORDER OF THE DATE

The date can be displayed in one of three formats: M/D/Y (month/day/year), D/M/Y (day/month/year), or Y/M/D (year/month/day).

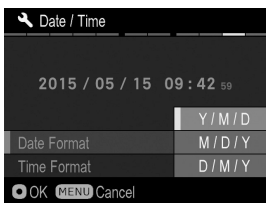

1

Use the buttons to select [**Date Format**], and press the or the button to open the sub menu.

2

Use the buttons to select your preferred format, and press the button or the button to confirm.

TO SWITCH 24 HOUR AND 12 HOUR (AM/PM) DISPLAY

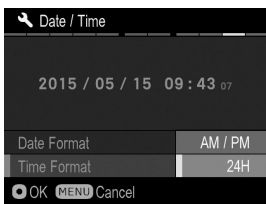

1

Use the buttons to select [**Time Format**], and press the button or the button to open the sub menu.

2

Use the buttons to select your preferred format and press the button or the button to confirm.

CAMERA SET-UP MENU

This section describes the various settings in the Camera Set-up menu. It is possible to set the camera functions from the Camera Set-up menu display.

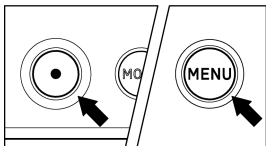

Tab area

TO DISPLAY THE SET-UP MENU

Press the **MENU** button on the back of the camera.

Press the **MENU** button again to close the Set-up Menu and the camera will be shooting mode. (If you reviewed images (P.96), it will return to the last previewed image.)

Move to any other tab

Each time the Front Dial or the Rear Dial is rotated, it will move to the next tab.

(When the icon in the tab area is selected, it is possible to change the setting menu by pressing the **<>** buttons as well.)

While in the Set-up Menu:

Use the **◀▶** buttons to select menu items.

Press the **OK** or **>** button to open sub-menus or dialogs.

While in set-up sub-menus:

Use the **◀▶** buttons to select setting options.

Press the **OK** or **>** button to apply new settings.

Press the **<** button to close sub-menus without applying changes.

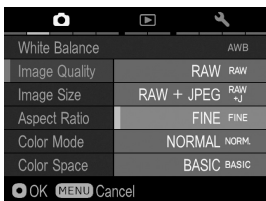
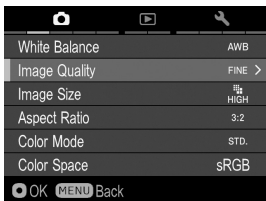

- The Camera Set-up menu is divided into three groups.



CAPTURE SETTINGS

(Blue Tab)

This menu relates to shooting settings. When an exposure mode is selected and the **MENU** button is pressed [ **Capture Settings**] will be displayed.



PLAYBACK MENU

(Red Tab)

This menu is for setting the playback related functions of the still images. The settings for printing, such as DPOF setting, is included in the Playback Settings menu.

If the **MENU** button is pressed during playback mode, [ **Playback Menu**] will be displayed.

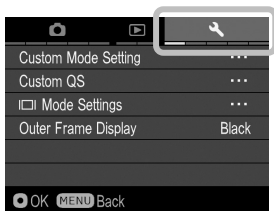

CAMERA SETTINGS

(Yellow Tab)

This menu is used for camera setup such as date and language selection.

Open the Camera Set-up menu by pressing the **MENU** button and move to the [ **Camera Settings**] menu by rotating the Front Dial or the Rear Dial.

TIP

- Depending on the settings of the camera, some menu items and setting options cannot be selected. They will be displayed with a gray color.

LIST OF MENU FUNCTIONS

For more detailed information about each function, please refer to the individual pages.

CAPTURE SETTINGS

| | Menu Item | Description | Page |
|---|----------------------|---|------|
|  (1) | ISO Sensitivity | The higher value indicates a higher sensitivity. (The Image may have more “noise” with higher sensitivities.) | 69 |
| | ISO Sensitivity Step | Sets the ISO Sensitivity in steps of 1EV or 1/3EV. | 70 |
| | Auto Bracketing | Sets the steps and order of Auto Bracketing. | 78 |
| | AE Metering Mode | Selects the Metering Mode depending on the shooting conditions. | 75 |
| | Drive Mode | Selects the Drive Mode such as Self-Timer. | 59 |
| | Flash | Sets the mode of flash setting and Flash Exposure Compensation. | 88 |

| | Menu Item | Description | Page |
|---|---------------|--|------|
|  (2) | White Balance | Selects the White Balance Mode depending on the shooting conditions. | 64 |
| | Image Quality | Selects the quality of image to record. | 71 |
| | Image Size | Selects recording Image Size. | 72 |
| | Aspect Ratio | Sets the aspect ratio of the image. | 73 |
| | Color Mode | Selects the desired Color mode depending on the shooting conditions. | 81 |
| | Color space | Sets the color space to [sRGB] or [Adobe RGB]. | 85 |

| | Menu Item | Description | Page |
|---|-------------------------|--|------|
|  (3) | Overexposure Correction | Sets or cancels the [Overexposure Correction] that minimizes blown out highlights at the time of overexposure. | 84 |

| | Menu Item | Description | Page |
|--|-----------------------------------|--|-----------|
|  (3) | Tone Control | Sets or cancels the [Tone Control] (Strong / Mild) that achieves the natural rendering image. | 85 |
| | Auto Rotate | Sets or cancels to record the vertical image information. | 86 |
| | Quick Preview | Sets the duration of the Quick Preview image that is automatically displayed on the color LCD monitor after the image is captured. | 42 |
| | Preview Exposure in M Mode | It is possible to select if the LCD Display reflects the selected exposure on the screen. | 49 |

| | Menu Item | Description | Page |
|--|------------------------------------|---|------------|
|  (4) | Switch Dial Functions | Sets the allocation of dials for exposure setting and exposure compensation in each shooting mode. | 129 |
| | Dial / Manual Ring Rotation | Sets the direction of Dials and Focus ring. | 129 |
| | AEL Button Settings | Sets the function that the AEL button will perform. | 76 |
| | Half pressed AEL | Sets or cancels the exposure lock when the shutter button is pressed halfway. | 77 |
| | Half-pressed AF-ON | It is possible to select whether or not to operate the AF function when the shutter button is half-pressed. | 56 |

| | Menu Item | Description | Page |
|--|------------------------------|---|-----------|
|  (5) | AF Auxiliary Light | Sets whether or not the AF auxiliary light is used in low light conditions. | 51 |
| | AF+MF | Select normal AF mode or AF+MF mode to allow manual focus override. | 52 |
| | MF Auto Magnification | Sets the duration for the image to return to normal display from MF Auto Magnification. | 58 |

| | Menu Item | Description | Page |
|---|--------------------------|---|-----------|
|  (5) | AF Limit Mode | Set whether or not the AF Limit Mode is added to the Focus Mode button. | 53 |
| | Speed Priority AF | Sets the AF mode between Normal AF mode or Speed Priority AF mode. | 56 |
| | Face Detection AF | Select normal AF Mode or Face detection AF Mode. | 55 |

PLAYBACK MENU

| | Menu Item | Description | Page |
|---|------------------|---|------------|
|  (1) | Lock | Lock the image, or unlock the locked image. | 106 |
| | Mark | Mark the image, or unmark the marked image. | 108 |
| | Rotate | Rotate the image to the desired position for display. | 110 |
| | Delete | Delete the image. | 103 |
| | Slideshow | Start the slideshow (playback images automatically) or change the slideshow settings. | 116 |
| | DPOF | Select the images and set the quantity for printing. | 118 |

| | Menu Item | Description | Page |
|---|---------------------------|--|------------|
|  (2) | RAW Development | It develops JPEG format images from RAW files. | 119 |
| | Exposure Warning | Sets whether or not the over-exposure warning is shown on images. | 112 |
| | OK Button Settings | Sets the function that the OK button will perform during image review. | 113 |
| | Image Rotation | Sets whether or not vertically orientated images are automatically rotated and displayed vertically. | — |
| | Sound Memo | Sets or cancels the Sound Memo, which can be recorded to a stored image. | 114 |

CAMERA SETTINGS

| | Menu Item | Description | Page |
|--|---|--|------------|
|  (1) | Custom Mode Setting | Register the setting of Custom Mode (C1 / C2 / C3). | 86 |
| | Custom QS | Selects which functions to allocate to the Quick Set menu. | 36 |
| | <input type="checkbox"/> Mode Settings | Sets or cancels the 6 Display Modes and its details. | 126 |
| | Outer Frame Display | Enables to set the Outer Frame Display on the shooting screen (when the aspect ratio is set other than 3:2). | 73 |

| | Menu Item | Description | Page |
|--|--------------------------------|---|------------|
|  (2) | MF Distance Scale Units | Sets the Manual Focus Scale Units when MF is used. | 57 |
| | Sound Settings | Sets the Shutter Sound, the Operation Sound, the Sound Volume and the Playback Volume for Sound Memo. | 132 |
| | Adjust Electronic Level | Adjusts the Electronic Level. | 128 |

| | Menu Item | Description | Page |
|--|-----------------------|--|------------|
|  (3) | File Name | Sets the File Name for the image. | 123 |
| | File Numbering | Sets the file numbering system used when a new card is inserted in the camera. | 122 |
| | ECO Mode | Sets or cancels ECO Mode that saves battery usage. | 131 |
| | LCD Brightness | Sets the color LCD monitor brightness. (Images will not be affected by this change.) | — |
| | LCD Off | Sets the delay before the backlight of the color LCD monitor turns off automatically if no operation has occurred. | 130 |

| | Menu Item | Description | Page |
|---|-----------------------|---|------------|
|  (3) | Auto Power Off | Sets the delay before the camera shuts down automatically if no operation has occurred. | 130 |

| | Menu Item | Description | Page |
|---|------------------------------------|--|-----------|
|  (4) | Eye-Fi Settings | It is possible to change the settings of the Eye-Fi Card that has a Wi-Fi communication function. | 92 |
| | Release Without Memory Card | Sets whether or not it is possible to release the shutter when the card is not inserted into the camera. | 41 |
| | Memory Card Format | Formats the card. (Formatting will erase all data on the card.) | 40 |
| | Date / Time | Sets the date and time in the camera's internal clock and the format in which the date and time will be displayed. | 26 |
| | Language / 言語 | Sets the language in which menus and messages will be displayed. | 25 |

| | Menu Item | Description | Page |
|--|------------------------------|---|------------|
|  (5) | Copyright Information | Holds copyright information and selects whether or not to save the information in the Exif data. | 124 |
| | Information | Displays the camera's firmware version, model name, serial number information, and certification mark*. | — |
| | Firmware Update | Confirm current firmware version and update the latest firmware version from card. | — |
| | Camera Reset | Restores all menu options to their default settings. | 133 |

* Certification Mark

Other Certification Marks that this camera supports are displayed at the bottom of the camera, on gift boxes, and in this instruction manual.

QUICK SET MENU

By pressing the **QS** button, it is possible to quickly access and change the settings of the following most commonly used camera functions.

Quick Set Menu (Default)

| | | |
|----------------------------|---|-------------------------|
| AE Metering Mode (P.75) |  | Drive Mode (P.59) |
| ISO Sensitivity (P.69) | | White Balance (P.64) |
| Image Quality (P.71) | | Color Mode (P.81) |
| Image Size (P.72) | | Aspect Ratio (P.73) |

Option list display of the selected items



When the camera is in the Still Image Mode, the Quick Set Menu will be displayed by pressing the **QS** button.

For example, to change the quality of image to RAW

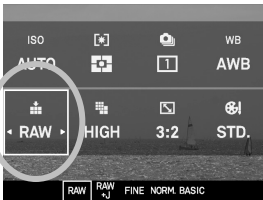

1 Press the **QS** button to display Quick Set Menu.

2 Press the **◀▶** buttons to select the section related to quality of image ().

3

Rotate the Front Dial or the Rear Dial to display **[RAW]**.

4

By pressing **OK** or the shutter button halfway, the settings will be applied and the camera will return to shooting mode.

CAUTION !!

- Items that you cannot set are displayed in gray, and the option cannot be changed by rotating the dials.

The functions allocated to the Quick Set menu can be changed.

Available functions to be allocated to the Quick Set menu

| | |
|-------------------------|------------------------------------|
| ISO Sensitivity (P.69) | Aspect Ratio (P.73) |
| AE Metering Mode (P.75) | Color Mode (P.81) |
| Drive Mode (P.59) | Exposure Mode (P.44) |
| White Balance (P.64) | Bracketing Amount (P.78) |
| Image Quality (P.71) | Flash Mode (P.90) |
| Image Size (P.72) | Flash Exposure Compensation (P.91) |

The function of the Quick Set menu can be set from [**Camera Settings**] (P.28) → [**Custom QS**]



1

Press the buttons on the [**Custom QS**] screen to select the item to change the allocated position, and press the **OK** button to confirm.

2

From the list at the bottom of the screen, use the buttons to select the item to allocate position, and press the **OK** button to confirm.

3

When you have finished setting the allocation, press the **MENU** button to close the [**Custom QS**] menu.

CHANGING THE COLOR LCD MONITOR DISPLAY



LCD Monitor Display can be changed by pressing the button.

OPERATION

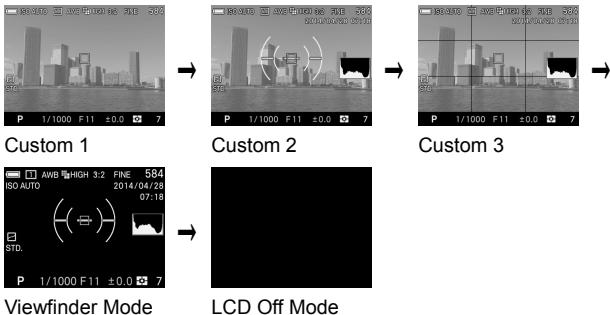

- Refer P.14 [COLOR LCD MONITOR INDICATION] for the meaning of each icon.
- In the View Finder Mode, only Icons will be displayed. This mode is convenient for shooting with the optional View Finder.
- Information to display on [Custom] can be customized (Refer P.126).
- The size of the icon displayed during operation on Viewfinder Mode and LCD Off Mode can be changed (Refer P.126).

REVIEWING

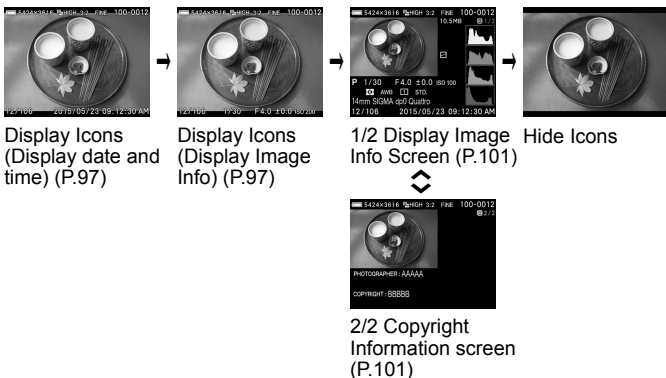

INSERTING AND REMOVING THE CARD

The dp0 Quattro camera uses a SD memory card, SDHC memory card and SDXC memory card to store data.

TO INSERT THE CARD

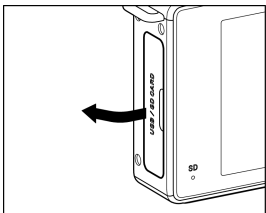

1

Turn off the camera and open the Card / USB cover as shown.

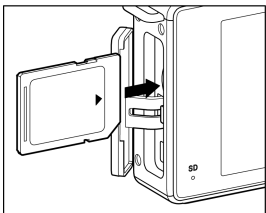

2

Insert the card in accordance with the instruction of Card / USB chamber.

Insert the card until it clicks.

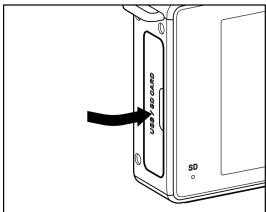

3

Close the Card / USB cover.

TIP

- It may be necessary to format the card before use. (See P.40)

TO REMOVE THE CARD

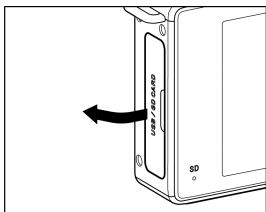

1

Turn off the camera and open the Card / USB cover as shown.

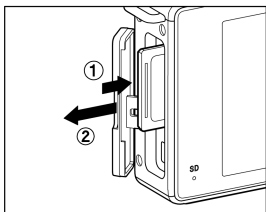

2

Push the card until it clicks and pull out it.

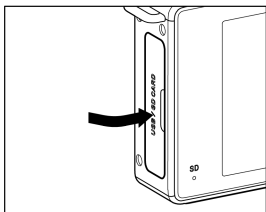

3

Close the Card / USB cover.

WARNING!!

- While the Busy Lamp is on or flashing, do not take out the battery or the card. By doing so, it may result in data loss. This could also cause damage to the camera and/or memory card.

TIP



- If the camera is turned off while the Busy Lamp is on, the camera will remain on until it has finished accessing the card.



FORMATTING THE CARD

New cards must be formatted before use. In addition, cards with corrupt or incompatible file systems may need to be formatted before use.

[ **Camera Settings**] (P.28) → Select [**Format**] and format the card.



In [**Format**] menu, Select [**Yes**] by pressing the  button and press the  button.

To cancel formatting, select [**No**] by using the  button and press the  button.

CAUTION !!

- Formatting erases all card contents, including locked dp0 Quattro files and all non-dp0 Quattro files.

TIP

- Cards formatted in other cameras or devices may not operate correctly in the dp0 Quattro camera or may have reduced capacity. To store the maximum number of dp0 Quattro files, format the card in the dp0 Quattro camera before use.

SHUTTER BUTTON

The shutter button of the dp0 Quattro cameras has two positions. When you press the shutter button “halfway down”, the camera’s autofocus systems will activate. When pressing the button “all-the-way down”, the shutter will release to take a picture.

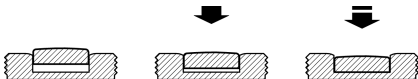

TIP

- Before you start to take pictures, we recommend that you operate the camera, to become familiar with the “halfway down” position and other features of the camera.
- Normally, if the card is not inserted in to the camera body, it is not possible to release the shutter. If you would like to release the shutter without a card, please set from [ **Camera Settings**] (P.28) → [**Release without Card**].

| | |
|-----------------------------|--|
| Disable (Default) | When the card is not inserted in the camera body, it is not possible to release the shutter. |
| Enable | It is possible to release the shutter, even if the card is not inserted in the camera body. |

QUICK PREVIEW



The dp0 Quattro camera can be set to automatically display a preview of each image immediately after it is taken. This is useful for instantly checking exposure and framing.

The Quick Preview Duration can be set from [ **Capture Settings**] (P.28) → [**Quick Preview**].

| | |
|-------------------------|--|
| Off | No preview image is displayed. |
| 2 sec. (Default) | Preview image is displayed for 2 seconds. |
| 5 sec. | Preview image is displayed for 5 seconds. |
| 10 sec. | Preview image is displayed for 10 seconds. |

TIP

- To manually turn off the Quick Preview image, press the shutter button half-way.

CAUTION !!

- It will not be possible to zoom in to the preview image, or change to another image while the Quick Preview is up.

BASIC OPERATION

This section describes basic operations to start taking photography.

SELECTING THE EXPOSURE MODE

The features and the operation methods of the four different exposure modes of the camera are explained below.

WARNING !!

- In this section, the instruction is written on the assumption that [Switch Dial Functions] of [Capture Settings] (P.28) is in the initial setting. If the actual proceeding is different with the instruction manual, see P.129 for instruction of [SWITCH DIAL FUNCTIONS].

SELECTING THE EXPOSURE MODE

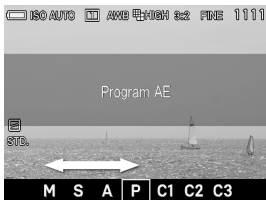

1

Press the Mode button (The mode selection will be displayed on the bottom of the LCD monitor.)

2

Select the desired exposure mode by using the Front and Rear Dials, or press the <> buttons.

3

Press the **OK** button or shutter button “half-way” to return to shooting mode.

P PROGRAM AE

To make picture taking easier, the camera will automatically select an appropriate combination of shutter speed and aperture value, according to the brightness of the subject.



1

Set the Exposure Mode to the **P** position. (The exposure indicator is illuminated in green.)

2

Press the shutter button “half-way” to verify the focus and take the picture.

WARNING !!

- When (() is shown on the color LCD monitor, the camera is set slower than 1/25. If this mark is displayed, please use the flash (P.88) or a tripod.
- If the subject is too bright or dark, both shutter speed and aperture value indicators will blink and will show the limit values. If you take a picture with these settings, the picture will be overexposed or underexposed.

PROGRAM SHIFT

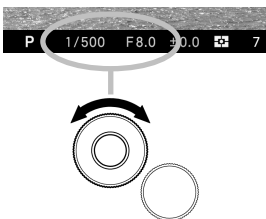

You can change the combination of shutter speed and aperture value, which were automatically selected by the camera. While turning the Front Dial, the combination of shutter speed and aperture value will change within the range of combinations that give the equivalent exposure.

- It will be canceled automatically, after taking the picture.

A APERTURE PRIORITY AE

After you set the aperture, the camera will determine the appropriate shutter speed. If you select smaller apertures, depth of field will be greater. Larger apertures tend to blur the background, as depth of field will be shallower.

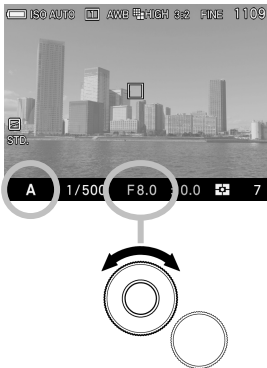

1

Set the Exposure Mode to the **A** position.
(The aperture value indicator is illuminated in green.)

2

Set the desired aperture value by rotating the Front Dial.

(The aperture value can be set in 1/3 stop increments from F4 to F22.)

3

Press the shutter button “half-way” to verify the focus and take the picture.

- Depending on the selected aperture value, the camera automatically sets the shutter speed in following range.

| Aperture | Shutter Speed |
|-------------|---------------|
| F4.0 ~ F5.0 | 30s ~ 1/1250s |
| F5.6 ~ F7.1 | 30s ~ 1/1600s |
| F8 ~ F22 | 30s ~ 1/2000s |

WARNING !!

- When (() is shown on the color LCD monitor, camera shake may occur (the shutter speed is set slower than 1/25). If this mark is displayed, please use the flash (P.88) or a tripod.
- If the appropriate shutter speed is outside the range of suitable combinations due to the subject being too bright or too dark, the shutter speed indicator will blink. If the subject is too bright, set the aperture value to a smaller one (larger F-number). If the subject is too dark, set the aperture value to a larger one (smaller F-number) until the indicator stops blinking.

S SHUTTER SPEED PRIORITY AE

When you set the desired shutter speed, the camera will select the appropriate aperture value for correct exposure. You can achieve stop action effects by selecting a fast shutter speed, or give the feeling of motion to a moving subject by selecting a slow shutter speed.



1

Set the Exposure Mode to the **S** position. (The shutter speed value is illuminated in green.)

2

Set the desired shutter speed by rotating the Front Dial.

(The shutter speed value can be set in 1/3 stop increments from 30 seconds to 1/2000 seconds.)

3

Press the shutter button “half-way” to verify the focus and take the picture.

- Depending on the selected shutter speed, the camera automatically sets the aperture in the following range.

| Shutter Speed | Aperture |
|---------------|------------|
| 30s ~ 1/1250s | F4.0 ~ F22 |
| 1/1600s | F5.6 ~ F22 |
| 1/2000s | F8.0 ~ F22 |

WARNING !!

- If the appropriate aperture value is beyond the range of the lens in use, due to the subject being too bright or too dark, the aperture value indicator will blink. If the subject is too bright, set the shutter speed to a faster one, or if the subject is too dark, set the shutter speed to a slower one, until the indicator stops blinking.

M MANUAL EXPOSURE

Set both the shutter speed and aperture value according to the indication of the exposure meter. You can change the exposure, as you desire.



1

Set the Exposure Mode to the **M** position.

(The shutter speed is illuminated in orange. The aperture value indicator is illuminated in green.)

2

Set the desired aperture value by rotating the Front Dial.

3

Set the shutter speed by rotating the Rear Dial to adjust the value of the exposure meter to ± 0.0 .

- The exposure meter can display an exposure error of up to ± 3 stops from the correct exposure in $1/3$ steps. If the exposure error is more than three

stops, the exposure meter will blink.

4

Press the shutter button “half-way” to verify the focus and take the picture.

- It is possible to change the combination of shutter speed and aperture value as follows.

| Shutter Speed | Aperture |
|---------------|------------|
| 30s ~ 1/1250s | F4 ~ F22 |
| 1/1600s | F5.6 ~ F22 |
| 1/2000s | F8.0 ~ F22 |

- When the aperture value is set to an unavailable value by changing the shutter speed value, the shutter speed value will be changed to an available value automatically.
- When the shutter speed value is set to an unavailable value by changing the aperture value, the aperture value will be changed to an available value automatically.

LCD DISPLAY IN M MODE

When the exposure is set as M mode, the LCD Display reflects the selected exposure on the screen so that photographers can confirm how the actual image will look. When the exposure is under, it becomes darker, and when it is over, it becomes brighter.

When you shoot images in M mode while using the flashguns from other companies, the display would be dark, and make it difficult to check the details of the image, such as the focus point and composition. In this case, it is recommended to change the setting to [Off], and adjust the brightness of the image on screen.

Select from [ Capture Settings] (P.28) → [Preview Exposure in M Mode].

| | |
|---------------------|--|
| Off | Brightness of the LCD Display is automatically adjusted for better visibility. |
| On (Default) | The selected exposure value is reflected in the LCD Display. |

TIP

- When ELECTRONIC FLASH EF-610 DG SUPER / ST SA-STTL is used with the camera, the brightness of the LCD Display is automatically adjusted for better visibility even when the function is [On].

FOCUSING

Adjustment of autofocus and manual focus operation are explained below.

FOCUS MODE

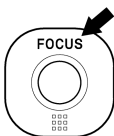

Each time the **FOCUS** button is pressed, AF mode (without an icon) and MF mode (**MF** icon) will alternate.

HOW TO USE AUTOFOCUS



Position the photographic subject within the centre of the composition and press the shutter button “half-way”.

- If autofocus is selected, the focusing point will be illuminated in green. (At the same time, the auto focus lamp will be illuminated in green.)
- If autofocus cannot set correctly, the focusing point will blink. (At the same time, the auto focus lamp will blink in red)
- The focusing distance is from 18cm to infinity.

Although your camera is equipped with highly precise AF system, in some cases autofocus cannot set correctly.

- Low-contrast subjects, such as blue sky or a blank wall, etc. or when the color of the subject is same as background
- The subject is located in a very low light environment
- Overlapping near and far objects, such as an animal behind a fence
- A subject, which moves at high speed

In such cases, please use one of the following focusing methods.

1. Use the Focus Lock function to focus on another subject, which has a similar focusing distance as your subject.
2. Set the lens to MF mode and focus manually.

AF AUXILIARY LIGHT

The built-in AF auxiliary light of the dp0 Quattro enables focusing in low light conditions.

- The effective distance of the AF auxiliary light is 3m.
- The AF auxiliary light can be turned off. Please set [📷 Capture Settings] (P.28) → [AF Auxiliary Light] → [Off].

SETTING THE FOCUS FRAME

The dp0 Quattro is equipped with two focusing modes. When using the “9 points select mode” it is possible to choose the desired focusing point from 9 different frames. When using “Free move mode” it is possible to move the desired point as you like. In addition, you can choose the size of the Focus Frame from three types [Spot], [Regular], [Large].

9 points select mode



Free move mode



Focusing point moving area

How to set :

Press the button.

- [9 points select mode] and [Free move mode] will be switched back and forth each time the **AEL** button is pressed.
- When [9 points select mode] is selected, choose the desired focusing point by pressing the buttons.
- When [Free move mode] is selected, move the focusing point as you like by pressing the buttons (focusing points can be moved inside the focusing point moving area).
- When the Front Dial or the Rear Dial is rotated, you can change the size of the Focus Frame.

Confirm by pressing the button.

FOCUS LOCK

This photographic method is useful if the subject is not positioned within the selected focusing point.

1

Position the photographic subject into the selected focusing point, and focus by pressing the shutter button “half-way”.

2

When the subject is in focus, the selected focusing point will be illuminated in green. Press the shutter button to take the picture.2

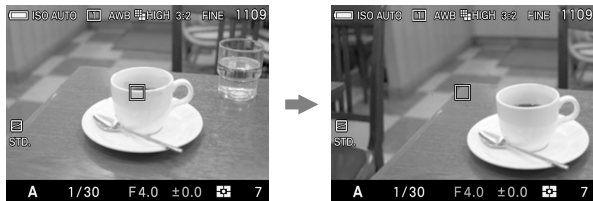

AF+MF MODE

It is possible to manually adjust the focus after verifying the AF.

1

Normal AF mode can be switched to AF+MF mode by selecting [Capture Settings] (P.28) → [AF+MF] → [On].



2

Press the **FOCUS** button and select AF+MF mode (AF/MF icon).

3

Press the shutter button halfway to verify focus.

4

While pressing the shutter button halfway and rotating the Focus ring, the display can be magnified. Adjust focus by rotating the Focus ring.

5

The enlarged display returns to normal one second after stopping rotation of the Focus ring. Compose the image as desired and take the picture.

- To return to normal AF mode, select [**Off**] in step **1**.
- The enlarged display will be magnified from the selected focusing point of the LCD monitor by pressing **OK** button. It is possible to set the enlarged area to be the same as the focusing point selection. See P.51 for information regarding focusing point.

WARNING !!

- It is not possible to set AF+MF Mode when Face detection AF mode setting is selected.

AF LIMIT MODE

The dp0 Quattro has an AF Limit Mode that can speed up the Auto Focusing while limiting the focusing range. Four optional modes are available and each is designed to offer a unique shooting function.

1

Limit mode can be set by selecting [**Camera Capture Settings**] (P.28) → [**AF Limit Mode**] → [**On**]. (AF Limit mode will be added to the Focus mode.)







2

Press the **FOCUS** button and select the AF Limit mode. (The icon of AF Limit Mode and the scale bar will appear at the bottom of the LCD display.)

3

Select the desired AF Limit mode by using the Front and the Rear Dial or press the **<>** buttons.

| | mode | Focusing Range |
|--|--|--|
|  | Macro | Approx. 1.8m ~ 0.5m (Approx. 0.59ft ~ 1.6ft) |
|  | Portrait | Approx. 0.3m ~ ∞ (Approx. 1ft ~ ∞) |
|  | Landscape / Snap shooting (Default) | Approx. 0.5m ~ ∞ (Approx. 1.6ft ~ ∞) |
|  | Custom | Personal Customization available (refer to the next article) |

4

By pressing **OK** or the shutter button halfway, the settings will be applied and the camera will return to shooting mode.

CUSTOM MODE SETTING



It is possible to customize the focus range and save the setting in **(C)** of AF Limit Mode.

1

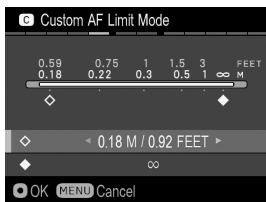
Select [**📷 Capture Settings**] (P.28) → [**AF Limit Mode**] → [**On**], and press the **>** button to go to the customization screen of the AF Limit Mode.



2

Select the  or  icon by using the **⬅** button, and set the desired focus range by using the **⬅** button while checking the scale bar on the screen.

- It is possible to set a value from the following 6 points between close and long range.

| | | |
|----------------|---------------|------------|
| 0.18m / 0.59ft | 0.22m / 0.7ft | 0.3m / 1ft |
| 0.5m / 1.6ft | 1m / 3.3ft | ∞ |

3

Press the **OK** button to apply the setting or the **MENU** button to return to the set-up menu without making any changes.

FACE DETECTION AF MODE

The dp0 Quattro offers Face Detection AF Mode that prioritizes to detect and focus on the faces in the image.



Normal AF mode can be switched to Face detection AF mode by selecting [ Capture Settings] (P.28) → [Face detection AF] → [On].



OFF



ON

Press  button and  button to set the Face Detection AF Mode ON/OFF.



A Face Detection Frame will appear in orange once faces are detected in the display.

Press the shutter button halfway, and the Face Detection Frame will turn green once it is properly focused on the face.

- When the Face Detection Mode is in operation, AE Metering Mode will be set to “Measuring” and focus on the detected faces in the image.
- It is possible to detect up to 8 faces at one time in an image, and the Face Detection Frame will appear on the closest face in the display.

CAUTION !!

- Face Detection AF Mode is unavailable when it is set in MF Mode.
- Face Detection AF Mode may not work well in the following conditions;
 - When a part of the face is covered by sunglasses, a hat, etc.
 - When the person is facing away from the camera.
 - When it is out of focus.
 - When the object is either too close or too far.
- When it does not detect faces well, it will switch to focus by the selected Focus Frame.

- To return to normal AF mode, select [ Capture Settings] (P.28) → [Face detection AF] → [Off].

SPEED PRIORITY AF

The Speed Priority AF enables faster autofocus by freezing the LCD monitor while focusing.

Normal AF mode can be switched to Speed Priority AF mode by selecting [📷 Capture Settings] (P.28) → [Speed Priority AF] → [On].

CAUTION !!

- As the LCD monitor freezes while the camera is autofocusing, a still image will be displayed when the shutter button is pressed halfway until the AF is finished.
- To return to normal AF mode, select [📷 Capture Settings] (P.28) → [Speed Priority AF] → [Off].

HALF-PRESSED AF-ON

It is possible to select whether or not to operate the AF function when the shutter button is half-pressed.

The Half-pressed AF-ON can be set in [📷 Capture Settings] (P.28) → [Half-pressed AF-ON].

| | |
|------------------------|---|
| Off | AF function does not operate when the shutter button is half-pressed. |
| On (Default) | AF function operates when the shutter button is half-pressed. |

When [Half-pressed AF-ON] is selected as [Off] while the **AEL** button is set as [AF-ON], the auto focusing will be isolated from the shutter button. Please refer to [SETTING THE AEL BUTTON] in P.76 for the details of the **AEL** button settings.

MANUAL FOCUS

In situations where autofocus or focus lock is not effective, you can focus manually.



1 Set the focus mode to MF mode by pressing the **FOCUS** button. (MF icon and “the scale bar” will be displayed on the color LCD monitor).

2 Turn the Focus ring until you get a clear sharp image.



The green bar which appears on both sides of the meter on the scale bar shows the depth of field. If you select larger apertures, the depth of field will be shallower (area in focus is narrower) and if you select smaller apertures, the depth of field will be greater (area in focus is wider).

WARNING!!

- The focus point on the scale bar and the depth of field may differ from the actual distance. Please use it as a guide only.

TIP

- It is possible to change the indicator of the scale bar. Select **M** (meters) or **FEET** (feet) from [**Camera Settings**](P.28) → [**MF Distance Scale Units**].

FOCUSING WITH MAGNIFICATION DISPLAY

It is possible to magnify the display by pressing the **OK** button while in MF mode. Press the **OK** button again to change to the normal display.

- Whilst the display is enlarged, the **Q** is displayed on the color LCD monitor. Press the shutter button “half-way” to return to the original display.
- The enlarged display will be magnified from the selected focusing point of the LCD monitor by pressing **OK** button. It is possible to set the enlarged area to be the same as the focusing point selection. See P.51 for information regarding focusing point.
- Whilst the display is enlarged, it is possible to change the magnification ratio by rotating the Front Dial or the Rear Dial. (Normally the magnification ratio is x8.0, and it is possible to change to x4.0.)

MF Auto Magnification

It is possible to magnify the display by pressing the shutter button halfway and rotate the focus ring.

- The enlarged display returns to normal one second after stopping rotation of the Focus ring.
- Change the duration for the image to return to normal display or set it off so the image is not going to be enlarged by rotating the focus ring. Refer to [**Camera Capture Settings**] (P.28) → [**MF Auto Magnification**] to set.





| | |
|-------------------------|---|
| Off | No magnification. |
| 1 sec. (Default) | Return to normal display after 1 second. |
| 2 sec. | Return to normal display after 2 seconds. |
| 5 sec. | Return to normal display after 5 seconds. |

OPERATION OF THE DRIVE MODE

Operation of the self-timer, and other functions of the camera are explained by the following:



Operation of The Drive Mode can be set in Quick Set Menu (P.35) or [ Capture Settings] (P.28) → [Drive Mode].

| | |
|---|---------------------------------|
|  | Single Capture (Default) |
|  | Continuous |
|  | Self Timer 2 sec. |
|  | Self Timer 10 sec. |
|  | Interval timer |

SINGLE FRAME SHOOTING

When you press the shutter button in the single frame-shooting mode, only one frame will be exposed. Then the camera will be ready for the next shot by advancing one frame. Single frame shooting mode is recommended for ordinary photography.

CONTINUOUS SHOOTING

In this mode, when you keep the shutter button fully depressed, the camera will take pictures continuously.

CAUTION !!

- Images taken in rapid succession, such as during Continuous shooting, are initially stored in the camera's internal memory buffer. Once the memory buffer is full, the shutter will be disabled until some images have been processed in the camera.



The number on the lower right of the color LCD monitor is the buffer capacity. It is the maximum number of frames for continuous shooting. (If the maximum number of frames for continuous shooting exceeds 9 frames, the display will not change from 9)

- The maximum number of frames and speed of continuous shooting are as follows:

| | | Image Size (Resolution mode) | | | |
|---------------|----------|------------------------------|------|-----|------|
| | | S-HI | HIGH | LOW | S-LO |
| Image Quality | JPEG | 7 | 7 | 12 | 12 |
| | | 3.7 | 3.7 | 4.5 | 4.5 |
| | RAW | / | 7 | 12 | / |
| | | / | 3.7 | 4.5 | / |
| | RAW+JPEG | / | 7 | 12 | / |
| | | / | 3.7 | 4.5 | / |

The upper rows show the maximum number of frames, the lower rows show the maximum shooting speed in continuous mode (frames per second).

SELF TIMER

When you want to include yourself in the picture or avoid camera shake, please use the self-timer.

Self Timer 2 sec

The shutter will be released 2 seconds after the shutter button is fully depressed.

Self Timer 10 sec

The shutter will be released 10 seconds after the shutter button is fully depressed.

After composing the picture, press the shutter button “half-way” and adjust the focusing. Then, press the shutter button the rest of the way and the self-timer will activate. During the self-timer operation you will hear an electronic beeping sound. The beeping sound will be much faster during the last two seconds, before the shutter is released.

- When [Camera Settings](P.28) → [Sound Settings] → [Operation Sound] menu is set to [Off], the electronic sound will not beep even if the self-timer is operated.

- If you want to cancel the self-timer operation, please turn off the camera.

INTERVAL TIMER

It is possible to take pictures automatically at selected intervals.

1

Select [📷 Capture Settings] (P.28) → [Drive Mode] → [Interval timer], and press the **➤** button to move the interval timer setting screen. (When the **OK** button is pressed after selecting [Interval timer], the current setting will be applied.)

When the Interval timer shooting mode is set in the Quick Set menu (P.35), select [⏸] and press the [□] button to display the Interval timer setting screen (By pressing the **OK** button or the shutter button halfway after selecting [⏸], the current setting will be applied.).

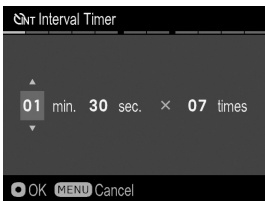

2

Set the desired interval and number of exposures by using the **⏪** and **⏩** buttons.

(Interval can be set from 4 seconds to 60 minutes. The number of exposures can be set between 2~99 times, or unlimited (∞).)

- Depending on the combination of Image Quality and Image Size, the shortest interval will vary.

| | | Image Size (Resolution mode) | | | |
|---------------|-------|------------------------------|-------|-------|-------|
| | | 📷S-HI | 📷HIGH | 📷LOW | 📷S-LO |
| Image Quality | RAW+J | / | 8sec. | 4sec. | / |
| | RAW | / | 8sec. | 4sec. | / |
| | FINE | 7sec. | 7sec. | 4sec. | 4sec. |
| | NORM. | 6sec. | 6sec. | 4sec. | 4sec. |
| | BASIC | 6sec. | 6sec. | 4sec. | 4sec. |

3

Press the **OK** button to apply the setting, and press the **MENU** button to go back to shooting mode.

4

Press the shutter button to start the interval timer shooting.

- During the interval timer shooting, the next exposure interval begins and the numbers of remaining exposures will be displayed.
- During the interval timer shooting, the auto focus lamp will blink in green.
- When the focus mode is set to AF, the AF will be locked at the first frame. From the second frame, pictures will be taken with the same focus position as the first frame.
- When the focus mode is set to MF, it is possible to change the focus during the interval timer shooting by turning the Focus ring.
(If you wish to keep the same focus position, ensure the Focus ring is not turned during the interval timer shooting.)
- If the selected interval is short, the camera may start to take the next image before the display returns to the shooting mode.
- Exposure value is measured at each interval shooting. If you wish to take pictures with the same exposure value, set the Exposure Mode to Manual Exposure or fix the exposure value by pressing the AEL Button before shooting.
- To terminate the interval timer shooting, press the Shutter button.
- Interval timer shooting cannot be used with the Auto Bracketing function.

WARNING !!

- The interval timer shooting will be terminated automatically if the battery is empty. We recommend using the AC adapter "SAC-6" (sold separately).
- Once you set the Interval Timer, the camera will continuously hold that Interval Timer. To dismiss the Interval Timer, switch to another modes in [**Drive Mode**].
- Depending on the settings, it takes time process the image. It may make the actual interval time longer than the selected time.

ADVANCED OPERATION

This section explains the application of the more advanced functions of your camera, when composing the expressions of your picture.









SETTING THE WHITE BALANCE (WB)

The color of light reflected by an object can vary depending on the color of the light source illuminating it.

For example, a neutral colored object will reflect reddish light under incandescent lighting, and greenish light under fluorescent lighting. The human brain is able to compensate for differences in the color of a light source, allowing us to see white objects as white, independent of the lighting condition. Film cameras rely on special color-correcting filters and film types to adjust for these differences in lighting. Digital cameras, however, are able to use software to mimic the adjustments made by the brain, so that colors that appear white to the human eye also appear white in your photographs.



WHITE BALANCE OPTIONS

| | OPTION | COLOR TEMP. | DESCRIPTION |
|---|---------------------------------|----------------|--|
| AWB | Auto (Default) | – | Select this setting to allow the camera to automatically determine the appropriate white balance adjustments. |
| AWB  | Auto (Lighting Source Priority) | – | Select this setting to allow the camera to automatically determine the appropriate white balance while valuing the color and atmosphere of light source. |
|  | Daylight | Approx. 5400 K | Select this setting when taking pictures in full sunlight. |
|  | Shade | Approx. 8000 K | Select this setting when taking pictures in the shade under sunny skies. |
|  | Overcast | Approx. 6500 K | Select this setting when taking pictures under cloudy, overcast skies. |
|  | Incandescent | Approx. 3000 K | Select this setting when taking pictures indoors under incandescent (tungsten) lighting. |
|  | Fluorescent | Approx. 4100 K | Select this setting when taking pictures indoors under fluorescent lighting. |
|  ^{WB} | Flash | Approx. 7000 K | Select this setting when taking pictures with the Sigma EF-610 DG SUPER / ST SA-STTL flash. |
|  | Color Temperature | – | Select this setting to adjust the white balance by setting color temperature in numerical value. |
|  | Custom | – | Select this setting to determine the white balance based on the image taken. (P.68) |

The White Balance can be set in Quick Set Menu (P.35) or [ Capture Settings] (P.28) → [White Balance].

ADJUSTING WHITE BALANCE

Each White Balance Mode can be adjusted.

1

Select preferred White Balance Mode from [**📷 Capture Settings**] (P.28) → [**White Balance**], and press the **➤** button to display the White Balance Adjustment screen.

To set from Quick Set Menu (P.35), select preferred White Balance Mode, and press the **|□|** button to display the White Balance Adjustment screen.

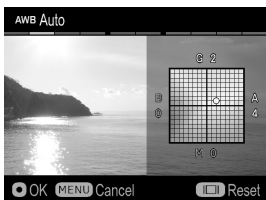

2

Press the **◀▶** buttons to adjust.

- B stands for Blue, A for Amber, M for Magenta, and G for Green. The image will be adjusted with colors in the moving direction.
- In each direction, adjustments can be made up to 8 steps.

3

To confirm, press the **OK** button. To return without making any changes, press the **MENU** button.

- To reset, press the **|□|** button.







When an adjustment was made, the adjustment value is displayed under the White Balance Icon.

SETTING THE VALUE OF COLOR TEMPERATURE

White Balance can be adjusted by setting the color temperature in numerical value.

1

Select [ **Capture Settings**] (P.28) → [**White Balance**] → [**Color Temperature **K****] and press the  button to display the Color Temperature setting screen.

To set from the Quick Set Menu (P.35), select [**K**], and press the [] button to display the Color Temperature setting screen. (After selecting [**K**] and pressing the  button or the shutter button “half-way”, images can be taken at the value set previously.)

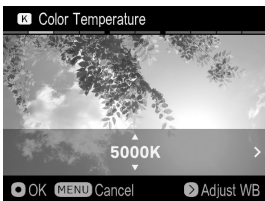

2

Press the  buttons to set the value.

3

To confirm, press the  button. To return without making any changes, press the **MENU** button.

White Balance can also be adjusted when setting the color temperature.

1

Press the  button to display the White Balance Adjustment screen on the Color Temperature Setting screen.

2

Follow the instruction **2** and onwards in [**ADJUSTING WHITE BALANCE**] in the previous page.

TIP

- Light source can be reddish or bluish, the color of light described as absolute temperature (K: Kelvin) is called “Color Temperature”. The lower the color temperature is, the more reddish the color of light turns out, and the higher, the more blueish. Please refer P.65 for the approximate color temperature of the light source.

SETTING A CUSTOM WHITE BALANCE

For more precise control of the white balance setting or when photographing under unusual lighting conditions, the "**Set Custom WB**" option can be used to capture a sample of neutral object in a scene to be used for color correction.

1

To capture a custom white balance image, please select [**Capture Settings**] (P.28) → [**White Balance**] → [**Custom**], then press the button. (When the button is pressed after selecting [**Custom**], the current white balance setting will be set.)

When a custom white balance is set in the Quick Set menu (P.35), select [] and press the [] button to display the custom white balance setting screen (By pressing the button or the shutter button halfway after selecting [], the current setting will be applied.).

2

Under the lighting conditions that will be used for the final photograph, frame a white colored object, such as a sheet of white paper or a white wall, so that it fills the frame in the center of the color LCD monitor. Then rotate the focus ring to adjust the focus point (the focus point does not have to be perfectly in position).

3

Press the **AEL** button and import the custom white balance image.

If a valid white balance settings was captured, a message "**White balance image captured successfully**" will appear on the color LCD monitor that the white balance image was captured successfully.

If the capture was not successful, "**Failed ! Please retry the custom WB capture.**" will be displayed on the color LCD monitor.

Press the **AEL** button to capture a white balance image once again.

To dismiss the capture, press the **MENU** button.

SETTING THE SENSITIVITY (ISO EQUIVALENCY)



The photosensitivity of digital cameras is described in terms of “ISO equivalent” like silver-halide film cameras.

The ISO Sensitivity can be set in Quick Set Menu (P.35) or [Camera Icon] **Capture Settings**] (P.28) → [ISO Sensitivity].

| | |
|--------------------------------------|-----------------|
| ISO Auto (ISO AUTO) (Default) | ISO 800 |
| ISO 100 | ISO 1600 |
| ISO 200 | ISO 3200 |
| ISO 400 | ISO 6400 |

CAUTION !!

- When Exposure Mode is set to M mode, it is not possible to select [ISO Auto]. When AUTO is selected in **S, A, P** mode and then changed to **M** mode, images are taken at the lower limit set in the next section [ISO AUTO RANGE].

ISO AUTO RANGE

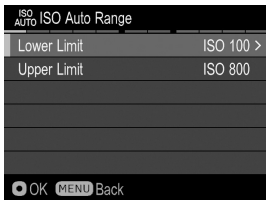

It is possible to set the Lower limit and Upper limit of the ISO Sensitivity in ISO Auto mode.

1

Select [**📷 Capture Settings**] (P.28) → [**ISO Sensitivity**] → [**ISO Auto**], and press the **>** button to move the ISO Auto Range setting screen. (When the **OK** button is pressed after selecting [**ISO Auto**], the current setting will be applied).

When the ISO Auto Range is set in the Quick Set menu (P.35), select [**ISO AUTO**] and press the **|□|** button to display the ISO Auto Range setting screen. (By pressing the **OK** button or the shutter button halfway after selecting [**ISO AUTO**], the current setting will be applied.)

2

Set [**Lower limit**] and [**Upper limit**].

Lower limit

| | |
|-------------------|---------|
| ISO 100 (Default) | ISO 400 |
| ISO 200 | |

Upper limit

| | |
|-------------------|----------|
| ISO 200 | ISO 1600 |
| ISO 400 | ISO 3200 |
| ISO 800 (Default) | ISO 6400 |

CAUTION !!

- It is not possible to set the same value to the Lower limit and Upper limit and reversed value.

By default, the ISO sensitivity step setting is 1 EV. However, it is possible to select 1/3 EV.

It is possible to set the ISO sensitivity from [**📷 Capture Settings**] (P.28) → [**ISO Sensitivity Step**].

| | |
|----------------|---|
| 1 EV (Default) | It is possible to set the ISO sensitivity step 1EV. |
| 1/3 EV | It is possible to set the ISO sensitivity step 1/3EV. |

When the 1/3 EV is selected, the following ISO sensitivity can be set.

| | | | |
|----------|---------|----------|----------|
| ISO AUTO | ISO 250 | ISO 800 | ISO 2500 |
| ISO 100 | ISO 320 | ISO 1000 | ISO 3200 |
| ISO 125 | ISO 400 | ISO 1250 | ISO 4000 |
| ISO 160 | ISO 500 | ISO 1600 | ISO 5000 |
| ISO 200 | ISO 640 | ISO 2000 | ISO 6400 |

TIP

- When Exposure Mode is set to [1/3 EV], Lower limit and Upper limit of ISO AUTO RANGE can be set in 1/3 steps.

IMAGE FILE SETTING

According to your preference, “Image Quality”, “Image Size” and “Aspect Ratio” of recorded images can be changed.

IMAGE QUALITY SETTING



It is possible to record images in the widely used JPEG or RAW formats.

Image Quality Setting can be set in Quick Set Menu (P.35), or [Capture Settings] (P.28) → [Image Quality].

| | | |
|-------|----------------|-------------------------------|
| RAW | RAW | RAW format |
| RAW+J | RAW+JPEG | RAW+FINE(JPEG) simultaneous |
| FINE | FINE (Default) | JPEG • High quality image |
| NORM. | NORMAL | JPEG • Standard quality image |
| BASIC | BASIC | JPEG • File size priority |

- RAW images are recorded without digital processing in the camera body and require post-processing with **Sigma Photo Pro** software which can convert RAW images to JPEG or TIFF format.
- **SIGMA Photo Pro** can be downloaded free of charge from the following website: <http://www.sigma-global.com>
- Without using a PC, it is possible for the dp0 Quattro to develop JPEG images from the RAW data (X3F file). Refer to P.119 [**DEVELOP RAW DATA INSIDE THE CAMERA**] for further information.

TIP

- When RAW+JPEG is selected, the Image Quality of JPEG will be FINE.
- When RAW+JPEG is selected, the selected Image Size will be applied to both the RAW and JPEG files.

IMAGE SIZE SETTING



The number of record pixels (Image Size) can be set.

Image Size Setting can be set in Quick Set Menu (P.35) or [**Camera Icon** Capture Settings] (P.28) → [**Image Size**].

| | | | |
|------|----------------|-------|-------------------------------------|
| S-HI | S-HI | 39.3M | 7,680×5,120 (When it is set as 3:2) |
| HIGH | HIGH (Default) | 19.6M | 5,424×3,616 (When it is set as 3:2) |
| LOW | LOW | 4.9M | 2,704×1,808 (When it is set as 3:2) |
| S-LO | S-LO | 2.5M | 1,920×1,280 (When it is set as 3:2) |

- [S-HI] and [S-LO] can be selected only when the image quality setting is set as JPEG (FINE, NORMAL, and BASIC).

ASPECT RATIO SETTING

Aspect Ratio of the image can be changed.

Aspect Ratio Setting can be set in Quick Set Menu (P.35) or [📷 Capture Settings] (P.28) → [Aspect Ratio].

| | |
|----------------------|---|
| 21:9 | Aspect Ratio similar to those of wide screens used in cinema. |
| 16:9 | Aspect Ratio the same as those of high vision TVs. |
| 3:2 (Default) | Aspect Ratio the same as those of 35mm film cameras. |
| 4:3 | Aspect Ratio the same as those of traditional TVs and PC screens. |
| 7:6 | Aspect Ratio is the same as those of 6x7 film cameras. |
| 1:1 | Aspect Ratio is the same as those of 6x6 film cameras. |

- Each image of Aspect Ratio is made by cutting images of this camera's standard Aspect Ratio 3:2.

TIP

- Images recorded as RAW format can be changed to different ratio in **SIGMA Photo Pro**.



When shooting with aspect ratio other than 3:2, the frame is normally displayed in black. By making it semi-transparent, it is possible to use it as a sports finder which allows users to check the surrounding areas of the image.

Select the setting from [🔧 Camera Settings] (P.28) → [Outer Frame Display].

| | |
|-------------------------|------------------------------|
| Black (Default) | Frame is displayed in black. |
| Semi-transparent | Frame is Semi-transparent. |

Combination of Image Quality • Image Size • Aspect Ratio results in approximate file size per image as follows.

When Image Size Setting is set to [S-H]

| Aspect Ratio | Image Size | Image Quality | | |
|--------------|-----------------|---------------|---------|---------|
| | | FINE | NORM. | BASIC |
| 21:9 | 25M (7680×3296) | 18.1 MB | 9.7 MB | 7.4 MB |
| 16:9 | 33M (7680×4320) | 23.7 MB | 12.7 MB | 9.5 MB |
| 3:2 | 39M (7680×5120) | 28.1 MB | 15.0 MB | 11.3 MB |
| 4:3 | 35M (6816×5120) | 25.0 MB | 13.3 MB | 10.0 MB |
| 7:6 | 33M (6352×5120) | 23.3 MB | 12.4 MB | 9.3 MB |
| 1:1 | 26M (5120×5120) | 18.8 MB | 10.0 MB | 7.5 MB |

When Image Size Setting is set to [HIGH]

| Aspect Ratio | Image Size | Image Quality | | | |
|--------------|-----------------|---------------|---------|--------|--------|
| | | RAW | FINE | NORM. | BASIC |
| 21:9 | 13M (5424×2328) | 50.4 MB | 8.4 MB | 4.8 MB | 3.6 MB |
| 16:9 | 17M (5424×3048) | 53.0 MB | 11.0 MB | 6.3 MB | 4.7 MB |
| 3:2 | 20M (5424×3616) | 55.1 MB | 13.1 MB | 7.5 MB | 5.6 MB |
| 4:3 | 17M (4816×3616) | 53.6 MB | 11.6 MB | 6.6 MB | 5.0 MB |
| 7:6 | 16M (4480×3616) | 52.8 MB | 10.8 MB | 6.2 MB | 4.6 MB |
| 1:1 | 13M (3616×3616) | 50.7 MB | 8.7 MB | 5.0 MB | 3.7 MB |

When Image Size Setting is set to [LOW]

| Aspect Ratio | Image Size | Image Quality | | | |
|--------------|------------------|---------------|--------|--------|--------|
| | | RAW | FINE | NORM. | BASIC |
| 21:9 | 3.1M (2704×1160) | 23.2 MB | 2.2 MB | 1.2 MB | 0.9 MB |
| 16:9 | 4.1M (2704×1520) | 23.9 MB | 2.9 MB | 1.6 MB | 1.2 MB |
| 3:2 | 4.9M (2704×1808) | 24.5 MB | 3.5 MB | 1.9 MB | 1.4 MB |
| 4:3 | 4.3M (2400×1808) | 24.1 MB | 3.1 MB | 1.7 MB | 1.2 MB |
| 7:6 | 4.0M (2224×1808) | 23.9 MB | 2.9 MB | 1.5 MB | 1.2 MB |
| 1:1 | 3.3M (1808×1808) | 23.3 MB | 2.3 MB | 1.3 MB | 0.9 MB |

When Image Size Setting is set to [S-L0]

| Aspect Ratio | Image Size | Image Quality | | |
|--------------|------------------|---------------|--------|--------|
| | | FINE | NORM. | BASIC |
| 21:9 | 1.6M (1920×816) | 1.1 MB | 0.6 MB | 0.5 MB |
| 16:9 | 2.0M (1920×1080) | 1.5 MB | 0.8 MB | 0.6 MB |
| 3:2 | 2.5M (1920×1280) | 1.8 MB | 0.9 MB | 0.7 MB |
| 4:3 | 2.2M (1696×1280) | 1.6 MB | 0.8 MB | 0.6 MB |
| 7:6 | 2.0M (1584×1280) | 1.5 MB | 0.8 MB | 0.6 MB |
| 1:1 | 1.7M (1280×1280) | 1.2 MB | 0.6 MB | 0.5 MB |

- The file sizes change depending on subjects.

SELECTING THE METERING MODE



The camera has three advanced metering modes.

The Metering Mode can be set in Quick Set Menu (P.35) or [Capture Settings] (P.28) → [AE Metering Mode]

| | | | |
|--|----------------------|-----|-------------------------|
| | Evaluative (Default) | [] | Center Weighted Average |
| | | [•] | Spot |

EVALUATIVE METERING

The camera divides its screen into 256 and measures the brightness of the scene by independently measuring each segment of the focusing screen and analyzing the correct exposure for the main subject under any lighting situation. Even under strong back lighting or complex lighting situations, the camera will give you the correct exposure.

[] CENTER WEIGHTED AVERAGE METERING

The camera will measure the average brightness of the entire scene with additional emphasis on the center area. It will determine the most suitable exposure with respect to lighting conditions.

[.] SPOT METERING

The camera will measure the brightness only inside of the selected focusing point on the color LCD monitor. This mode is suitable when you wish to set exposure for a portion of the scene and ignore the influence of rest of the scene.

AE LOCK

The camera will fix and memorize the exposure value whilst the “AE” Lock button is depressed. When you wish to lock the exposure of a subject off-center, AE lock is very useful. Use of this function with Spot Metering Mode is recommended.



1

Center the subject, for which you wish to lock the exposure inside the color LCD monitor and press the **AEL** button. (With spot metering, set the subject for which you wish to lock the exposure to the selected focusing point, and press the **AEL** button.)

The exposure value is memorized and **AEL** is displayed in the upper part of the color LCD monitor.

2

Compose the picture and press the shutter button.

- It is possible to continue taking pictures with the memorized exposure value until this setting is disabled by pressing the **AEL** button again.

SETTING THE AEL BUTTON

It is possible to use the **AEL** button to select settings other than AE Lock [**AEL**].

The AE Lock can be set in [**Camera Capture Settings**] (P.28) → [**AEL Button Settings**].

| | |
|----------------------|----------------|
| AEL (Default) | AEL+AFL |
| AFL | AF-ON |

AEL

It is the normal operation of AE Lock. Refer the above section [AE LOCK].



AFL

Press the **AEL** button to lock the focus. Until pressing the button again, images are taken with the same focusing point (Exposure can be locked when pressing shutter “half-way”).



AEL + AFL

Press the **AEL** button to lock both AE and Focus simultaneously. Until pressing the **AEL** button again, images are taken with the same exposure and focusing point.

AF-ON

While pressing the **AEL** button, Auto Focus continues to operate until focusing is set. Once focusing is set, it is locked and once shutter is released, focus lock is cancelled.

HALF PRESSED AEL

It is possible to set the exposure lock when the shutter button is pressed “half-way” or cancel the exposure lock.

The Half Pressed AEL mode can be set in [📷 Capture Settings] (P.28) → [Half Pressed AEL].

| | |
|---------------------|---|
| OFF | The exposure will not be locked while pressing the shutter button “half-way”. The exposure will be determined when depressing the shutter button. |
| ON (Default) | The exposure will be locked when the shutter button is pressed “half-way”. While pressing the shutter button is “half-way”, the exposure will not change. |

EXPOSURE COMPENSATION

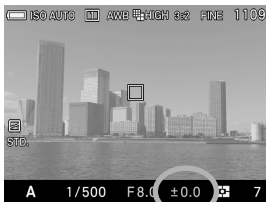

If you want to intentionally overexpose or underexpose the picture, use this function.

Select the desired compensation value by rotating the Rear Dial.

- Exposure compensation can be set in 1/3 stop increments from +3.0 to -3.0 stops.

CAUTION !!

- The exposure compensation will not disable automatically. After taking the picture, set the compensation value to ± 0.0 by rotating the Rear Dial.
- Exposure compensation function cannot be used with Manual Operation mode.

AUTO BRACKETING

This function of the camera lets you take a sequence of pictures of the same subject at three different exposure levels; Appropriate Exposure, Under Exposure and Over Exposure. If it is difficult to determine the proper exposure, please use this function.



1

Select [**Camera Capture Settings**] (P.28) → [**Auto Bracketing**] → [**Bracketing Amount**], and press the **➤** button or the **OK** button.

2

Use the **⬅** buttons to set the bracketing amount.

- It can be set in 1/3 stop increments up to ± 3

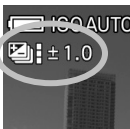

3

Press the **OK** button to confirm, press the shutter button “half-way” to return to shooting mode. (The Auto Bracketing icon will be displayed on the bottom right corner of the LCD monitor.)

- The camera will take three pictures in the following sequence; Appropriate exposure, under exposure and over exposure.
- The operations in each Drive Mode are shown below.

| | |
|-------------------------------|--|
| Single Capture | Each time the shutter button is pressed, an image will be taken one frame at a time. |
| Continuous | Three frames will be taken continuously by pressing and holding the shutter button. |
| Self Timer 2 sec. | 2 seconds after pressing the shutter button, three frames will be taken continuously. |
| Self Timer 10 sec. | 10 seconds after pressing the shutter button, three frames will be taken continuously. |

CAUTION !!

- This function cannot be used with the interval timer shooting.



- The exposure bracketing can be used with 4 different modes.

| | |
|---------------|--|
| P Mode | Both shutter speed and aperture value will be changed. |
| A Mode | Only shutter speed will be changed. |
| S Mode | Only aperture value will be changed. |
| M Mode | Only shutter speed will be changed. |

WARNING !!

- Once you set the auto bracketing mode, the camera will continuously hold that auto bracketing mode until you set the bracketing amount to “±0.0”.
- Auto Bracketing function cannot be used with the flashgun.

- Auto bracketing icon will change as follows depending on the frame number.

| First Frame | Second Frame | Third Frame |
|---|---|---|
|  |  |  |

- It is possible to change the Auto Bracketing Order.

The Auto Bracketing Order can be set in [📷 Capture Settings] (P.28) → [Auto Bracketing] → [Bracketing Order]

| | |
|------------------------|---|
| 0 → - → + (Default) | appropriate exposure → under exposure → over exposure |
| - → 0 → + | under exposure → appropriate exposure → over exposure |
| + → 0 → - | over exposure → appropriate exposure → under exposure |

Auto Bracketing mode can be used in combination with Exposure Compensation.

You can take pictures with Auto Bracketing mode based on a compensated exposure, which you set. To do so, please set both the Auto Bracketing mode and Exposure Compensation mode as desired. The combined value (Exposure Compensation and Auto Bracketing) will be indicated on the viewfinder display.

Example : Exposure Compensation +1.7 with Auto Bracketing amount 1.0

| | |
|--------------|--|
| First Frame | +1.7 (Exposure compensation +1.7 & no shift value) |
| Second Frame | +0.7 (Exposure compensation +1.7 & shift value -1.0) |
| Third Frame | +2.7 (Exposure compensation +1.7 & shift value +1.0) |

COLOR MODE

It is possible to select the desired Color mode depending on the shooting conditions. In addition to the above settings, Monochrome photography mode can be selected.

The Color Mode can be set in the Quick Set Menu (P.35) or [ **Capture Settings**] (P.28) → [**Color Mode**].

| | |
|--------------------------------------|---|
| STD. Standard (Default) | Standard color mode for various situations. |
| VIVID Vivid | Saturation and contrast are enhanced for making pictures appear vivid. |
| NTR. Neutral | Subdued saturation and contrast makes images natural. |
| PORT. Portrait | This color mode makes skin tone soft. It is ideal for portraits. |
| LAND Landscape | This mode makes blue and green more vivid and emphasizes pictures. |
| CINE Cinema | This mode reduces saturation and emphasizes shadows to recreate an image like in a cinema. |
| Sun R. Sunset Red | This mode emphasizes red color rendering, and expresses the scenes, such as sunsets, more impressively. |
| For G. Forest Green | This mode emphasizes green color rendering, and expresses greens, such as plants, more impressively. |
| Fov B. FOV Classic Blue | This mode recreates impressive blue sky, with the expression of rich blue tone. |
| Fov Y. FOV Classic Yellow | This mode recreates an impressive and rich color tone with the emphasis on yellow-like color. |
| MONO. Monochrome | It is possible to take Monochrome pictures. |



- The selected color setting icon is displayed on the color LCD monitor.

TIP

- In **Sigma Photo Pro**, Monochrome mode is designed for RAW data capture using **MONO**. (Monochrome) mode. **Sigma Photo Pro** can convert Monochrome RAW images into color however it is not possible to convert Monochrome JPEG images into color.

COLOR MODE DETAILED SETTING

With each color mode, image parameters (Contrast, Sharpness, and Saturation) can be adjusted to create preferred images.

Contrast

Contrast can be increased by moving the cursor to + side, or decreased, preserving image detail, by moving the cursor to - side.

Sharpness

It is possible to make the pictures appear sharper, by moving the cursor to + side, or softer by moving the cursor to - side.

Saturation (Except Monochrome)

It is possible to increase saturation thus making pictures appear vivid, if the cursor is moved to + side. Moving the cursor to - side, decreases saturation and makes images less vivid.

Filtering Effect (Only with Monochrome)

Contrast can be changed on Monochrome images. To the color of filters, similar colors are expressed brighter, and complementary colors are expressed darker.

| | | |
|-----------------------------|---------------------|---------------------|
| OFF Off (Default) | YE Yellow | OR Orange |
| R Red | G Green | B Blue |

- Normally, set it to **[OFF]** (Off).

Toning Effect (Only with Monochrome)

Monochrome images can be finished with preferred color tones.

| | | | | |
|-----------------------------|------------------|--------------------------|--------------------------|--------------------|
| B/W B&W (Default) | R Red | WARM Warm Tone | SEPIA Sepia | G Green |
| BG Blue Green | B Blue | COLD Cold Tone | BP Blue Purple | P Purple |

1

Select your preferred Color Mode from [📷 Capture Settings] (P.28) → [Color Mode], and press the **➤** button to display Color Mode Detailed Setting screen.

To set from Quick Set Menu (P.35), select preferred Color Mode, and press the **□** button to display Color Mode Detailed Setting screen.

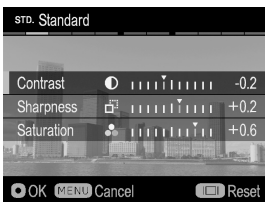

2

Press the **⬆** buttons to select [Contrast], [Sharpness] or [Saturation] on the Color Mode Detailed Setting screen, and use the **⬅** buttons to select adjustment value (Adjustable up to ± 1.0 with 0.2 steps) or set the preferred option.

3

Press the **OK** button to apply the setting or the **MENU** button to close the sub-menu without making any changes.

- To reset, press the **□** button.



If you adjust image parameters, their icon is displayed on the left of the color LCD monitor.

TIP

- JPEG files are compressed after a parameter adjustment. In the case of the RAW format, parameter information is recorded without adjustment. It is possible to re-adjust RAW images using **Sigma Photo Pro** software.

OVEREXPOSURE CORRECTION



Blown-out highlights caused by overexposure can be corrected, based on the gradation information obtained through the arrangement of pixels on the sensor, to minimize loss of detail.

Overexposure Correction : Off

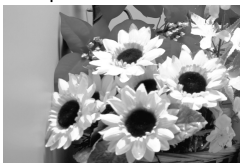

Overexposure Correction : On

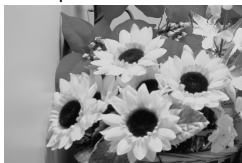

Select [On] from [ Capture Settings] (P.28) → [Overexposure Correction].

CAUTION !!

- In the following circumstances, Overexposure Correction does not work even when you turn it [On]. (The  icon on screen will turn to grey.)
A. When shutter speed is set lower than 0.8 sec. **B.** When ISO is set higher than ISO400.
- Depending on light conditions, it cannot be adequately adjusted even with Overexposure Correction, which causes tinting on a part of the subject. In this case, please turn Overexposure Correction [**Off**].

TONE CONTROL

By automatically optimizing the tone curve according to the scene, even for the scene with high contrast, the image can have a natural tone.

Tone Control : Off



Tone Control : Strong



Set from [📷 Capture Settings] (P.28) → [Tone Control]

| | | |
|-------------------------------------|-----------------------|--------------------------------|
| OFF | Off | Set Tone Control function OFF. |
| <input type="checkbox"/> | Mild (Default) | Mild effect can be achieved. |
| <input checked="" type="checkbox"/> | Strong | Strong effect can be achieved. |

CAUTION !!

- Depending on the scene, noise may be visible due to the correction effect. In such case, set it to [Off].

COLOR SPACE

It is possible to select sRGB, which is a common color space or Adobe RGB, which is mainly used for commercial printing, and other industrial purposes.

Color Space can be set in [📷 Capture Settings] (P.28) → [Color Space].

| | |
|-----------------------|------------------|
| sRGB (Default) | Adobe RGB |
|-----------------------|------------------|

CAUTION !!

- Please set the color space to sRGB for regular usage. If you select Adobe RGB, please be sure to use the **Sigma Photo Pro** software or another image processing software supporting DCF 2.0.

AUTO ROTATE

It is possible to record the vertical image information to images.

The Auto Rotate can be set by [ **Capture Settings**] (P.28) → [**Auto Rotate**].

| | |
|---------------------|--|
| Off | The vertical image information will not be recorded. |
| On (Default) | The vertical image information will be recorded. |

- When vertically orientated images are reviewed, they will automatically rotate and be displayed vertically.
- When vertically orientated images are reviewed in **Sigma Photo Pro**, they will automatically rotate and be displayed vertically.
- When vertically orientated images are rotated by pressing [ **Playback Menu**] → [**Rotate**], this rotated orientation will be stored.

WARNING !!

- If the images are taken while the camera is pointed up or down, the vertical position information may not be recorded properly.

CUSTOM MODE

It is possible to customize the Custom Mode Setting. (Up to three patterns can be stored.)

The following settings are available.

- All items in [ **Capture Settings**] (Blue Tab) (P.28)
- Exposure mode (**M, S, A, P**) (P.44)
- Setting Value for Aperture / Shutter
- Setting the focus frame (P.51)
- Exposure compensation (P.78)

SAVE THE CUSTOM MODE SETTING



Set the above settings to your desired combination.

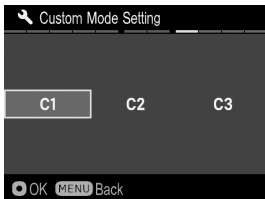

2

In [**Camera Settings**] (P.28) → [**Custom Mode Setting**], select from **C1**, **C2** or **C3** by using **<>** buttons. After selecting, press the **OK** button. A confirmation dialog will appear.

3

Use the **<>** buttons to select [**Yes**], and press the **OK** button to confirm.

To cancel, use the **<>** buttons to select [**No**] and press the **OK** button.

WARNING !!

- When the new setting is saved, the previous stored setting will be overwritten.

LOAD THE CUSTOM MODE SETTING

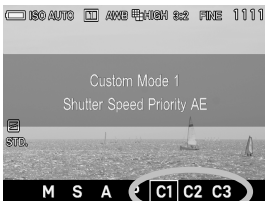

Press the Mode button and set to **C1**, **C2** or **C3**.



In custom mode, it is possible to change the above settings temporarily (except Exposure Mode).

If the setting is changed, • mark will appear in Function Display.

Return to original registered setting by doing the following.

- Turn the camera off (this includes the camera turning off automatically with the Auto Power Off function)
- Press the Mode button and set to another position.

USING THE EXTERNAL FLASH

This section explains how to use external flashguns.

THE EXTERNAL FLASH

The dp0 Quattro camera is equipped with a hot shoe, allowing the use of external flashguns. Please refer to the following table for the compatibility and available functions.

| | EF-610 DG SUPER S-TTL | EF-610 DG ST S-TTL |
|--------------------------------|--------------------------|-----------------------|
| TTL Auto Flash | ○ | ○ |
| Manual Flash | ○ | ○ |
| FP Flash | × | |
| Second Curtain Synchronization | × | |
| Redeye Reduction Flash *1 | ○*2 | ○ |
| Modeling Flash | ○ | |
| Flash Exposure Compensation *1 | ○*2 | ○ |
| Multi Flash Mode | × | |
| Bounce Flash | ○ | ○ |
| Wireless Flash | × | |
| Normal Slave Flash | × | |
| Designated Slave Flash | × | |
| Slow Synchro Mode *1 | ○ | ○ |

*1 It is possible to change the setting in the camera.

*2 For this function, only the camera's settings will be used and will override the flashgun settings.

- Please refer to the instruction manual of the flashgun when you check the details of how to change the device settings.
- It is not possible to use the AF Assist Light.

WARNING !!

- Please make sure that a wide panel is always attached during the use.

TTL AUTO FLASH

In the TTL AUTO Mode, the camera will control the amount of flash lighting to provide the appropriate exposure for the subject. (Please use this mode for ordinary photography.)

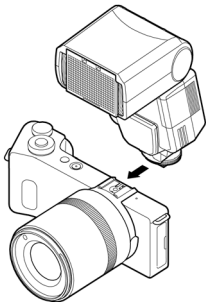

1

Turn off the camera and remove the hot shoe cover.

2

Attach the flashgun by referring to its instruction manuals.

3

Turn on the camera and follow the steps described in the instruction manual and set the flash mode to TTL.

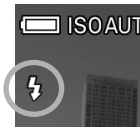

4

Make sure that the Flash Mode icon is displayed on the LCD monitor.

WARNING !!

- Please be aware that when you charge the external flash, the flash mode icon will turn on and off. If you release a shutter during such time, it will not flash and causes camera shake or underexposure.
- When camera exposure mode **P**, **A**, or **S** is used, shutter speed can be set up to 1/200 sec. (There is no limit when **M** mode is used.)





TIP

- If the ISO sensitivity setting is set to **[ISO AUTO]** and the external flash is used, the value set in **[Lower limit]** of **[ISO Auto Range]** will be applied.

SETTING THE FLASH MODE

It is possible to select other flash modes such as Exposure Compensation mode or Red-Eye Reduction mode.

The Flash Mode can be set in the Quick Set Menu (P.35) or  **Capture Settings** (P.28) → **[Flash]** → **[Flash Mode]**.

| | |
|---|-------------------------------|
|  | Normal Flash (Default) |
|  | Redeye |
|  | Slow Sync. |
|  | Redeye + Slow |

NORMAL FLASH

When you use the external flash, you can use your camera in this mode.

- Please use this mode for ordinary photography.

RED-EYE REDUCTION FLASH (REDEYE)

When taking a picture with flash, sometimes the person's eyes reflect the flash light and the "reducing" phenomenon will appear in the picture. In order to avoid this effect, the light flashes for about one second before the picture is taken to reduce the effect of red-eye.

- Depending on the lighting and subject conditions, the Redeye Reduction flash may not completely eliminate the redeye in all cases.

SLOW SYNCHRO MODE

When using the flash with **P / A** mode, the shutter speed value is limited to faster than 1/20. The slow synchro mode changes the shutter speed up to 30 second depending on light condition. This mode is suitable for a portrait in a nightscape.

CAUTION!!

- The Flash Mode can not be set if the flashgun is not attached to the camera, or the flashgun is turned off.
- It is not possible to use the Red-eye reduction flash when Manual Flash mode is selected on the external flash unit.

FLASH EXPOSURE COMPENSATION

It is possible to compensate the flash output level without changing the background's exposure.

The Flash Exposure Compensation can be set from [📷 Capture Settings] (P.28) → [Flash] → [Flash Exposure Compensation].

Select the desired compensation value by using the ⬆️ buttons.

- Flash Exposure compensation can be set in 1/3 stop increments from +3.0 to -3.0 stops.

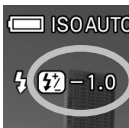

- When the Flash Exposure Compensation is set, the icon and compensation value will be displayed on the left of the LCD monitor.

CAUTION!!

- The flash exposure compensation can not be set if the flashgun is not attached to the camera, or the flashgun is turned off.
- The flash exposure compensation will not disable automatically. After taking the picture, set the compensation value to ± 0.0 by above procedure.

USING Eye-Fi CARD (Eye-Fi Connected)



By using Eye-Fi Card with Wi-Fi communication function (sold separately), it enables a camera to transfer the images to smartphones or a PC wirelessly.







- It is the Eye-Fi card that has the feature to transfer images. For the details of the usage of the card and how to set it up, please refer to the instruction manual of the Eye-Fi card.
- Depending on the specification of the Eye-Fi, it might be possible to transfer images in RAW format. For more information, please refer to the instruction manual of the Eye-Fi card.

Once you insert the Eye-Fi card into the camera, it is possible to configure [Eye-Fi Setting] → [Eye-Fi Transfer] in [🔧 Camera Settings] (P.28).

Eye-Fi Transfer

| | |
|------------------------|---|
| Off | It disables the communication and image transfer functions of the card. Its function becomes as same as usual memory cards. |
| On (Default) | It automatically transfers the images, based on the settings of the Eye-Fi card. |

- It is possible to check the Wi-Fi connection with the  icon on the display.

| | |
|--|--|
|  (No signal) | [Eye-Fi Transfer] is turned off. |
|  (Gray) | Not connected to other devices. |
|  (White Blinking) | Trying to connect to other devices. |
|  (White) | On standby for transferring images. |
|  (Animation) | Transferring images. |
|  | Error in the communication of the Eye-Fi card. (Please reboot the camera. If the same icon keeps appearing, it might be the malfunction of the camera.) |

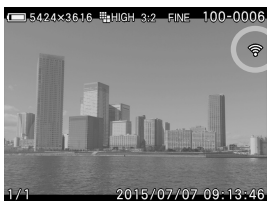

- The images with  icon have been transferred.

- It is possible to check the device information of the Eye-Fi card and the status of Wireless communication.

Information to check: Connected SSID
MAC address of the Eye-Fi card
Firmware version of the Eye-Fi card

It is possible to check the information from [ **Camera Settings**] (P.28) → [**Eye-Fi Settings**] → [**Connection Information**].

CAUTION !!

- The communication is interrupted if the camera is turned off during the transfer. It resumes when the camera's power is switched on again.
- Please check that use of the Eye-Fi card is allowed in your country or region. Please use it only if it complies with the laws in the country or region.
- In some cases, it is possible that the Eye-Fi card keeps sending radio waves even when the function is set to **[Off]**. Please remove the card from the camera when emitting the radio wave is strictly prohibited, such as in hospitals or airplanes.
- Depending on the wireless connection, the transferring process might be slow or interrupted.
- In case images are taken during image transferring, it may pause the communication and transfer for a moment. Once the images are written to the memory card, it continues the transfer process.
- In case the image transfer does not operate well, please refer to the instruction manual of the card, and check the settings of both of the card and the computer.
- The communication and transfer of the Eye-Fi card requires higher consumption of the camera battery, so the battery will run out faster than usual.
- For images with Sound Memo (P.114), it is not possible to transfer the sound data, and only the image data will be transferred.

REVIEWING AND DELETING IMAGES

This section explains how to review and delete images after they have been captured.

REVIEWING IMAGES

The pictures captured by the dp0 Quattro can be reviewed in various ways.

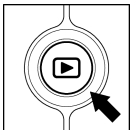

To review images captured by the dp0 Quattro camera press the  button on the back of the camera. The last image recorded on the card will be displayed on the color LCD monitor.



Press the  button to display an image on the color LCD monitor.

Press the  button again to change to shooting mode.

TIP

- Even if the camera is switched off, images can be reviewed by pressing and holding the  button for 2 seconds.
- If no new images have been captured, the last reviewed image will be displayed.
- If there are no images on the card, an error message “No images on Memory card” will be displayed.
- When reviewing images, if the  button is pressed or the shutter button is pressed “half-way”, the dp0 Quattro will be changed back to shooting mode.



CAUTION!!

- The dp0 Quattro may not be able to display images captured by other cameras, or “dp0 Quattro” images that have been renamed or moved from the DCIM folder on the card.

VIEWING ONE IMAGE AT A TIME

Press the  button on the back of the camera to see the recorded images in Single-Image View.

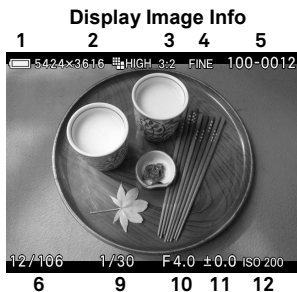
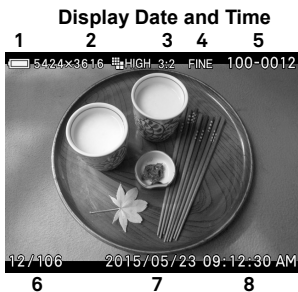

WHILE IN SINGLE-IMAGE VIEW:

- Rotate the Rear Dial to see the previous or next images.
- Press the  button to see the next image.
- Press the  button to see the previous image.
- Press the  button to switch the information as follows (P.36).



| | |
|--------------------------------------|--------------------------------|
| 1 Battery Level Indicator | 7 Date |
| 2 Image Size | 8 Time |
| 3 Aspect Ratio | 9 Shutter Speed |
| 4 Image Quality | 10 F Number |
| 5 Folder numbering - File numbering | 11 Exposure Compensation Value |
| 6 File number / Total files recorded | 12 ISO Sensitivity |

TIP

- To scroll through images more quickly, press and hold the  buttons. Images will advance automatically until the button is released.
- The first and last recorded images on the card are linked. Pressing the  button while the first image is displayed brings up the last recorded image on the card. Pressing the  button while the last image is displayed brings up the first recorded image on the card.

MAGNIFYING IMAGES (ZOOMED-IN VIEW)

Reviewed images can be magnified, making it possible to check image details and focusing.

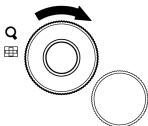





While reviewing images, rotate the Front Dial to the  position.

The magnification ratio will be changed as follows.

Original→X1.25→X1.6→X2.0→X2.5→X3.15→X4.0→X5.0→X6.3→X8.0
→X10.0

WHILE IN ZOOMED-IN VIEW:

- Rotate the Front Dial to the  position to increase magnification.
- Rotate the Front Dial to the  position to decrease magnification.
- Press the  buttons or the  buttons to pan around the image.
- Press the  button to return to the original ratio.
- Rotate the Rear Dial to see the previous or next images.

TIP

- Images are magnified based on the position of the focus point during shooting.

VIEWING NINE IMAGES AT A TIME (CONTACT SHEET VIEW)

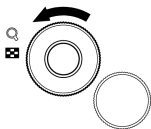

Images can be viewed in a "contact sheet" of nine thumbnail images.



While reviewing images, rotate the Front Dial to the  position.



WHILE IN CONTACT SHEET VIEW:

- Press the  buttons to change the thumbnail image selection.
- Rotate the Front Dial to the  position, the selected thumbnail image will be reviewed.
- Rotate the Rear Dial to see the previous or next pages.

TIP

- The first and last page are linked. The first page is displayed after the last page.

VIEWING IMAGE INFORMATION

The Image Info Screen contains additional information about each image.

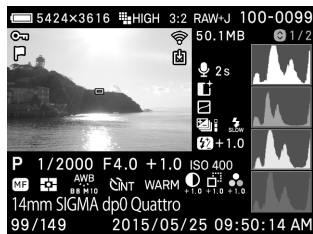

Press the  button several times from the Single-Image or Zoomed-In View.



| | | | |
|----|--|----|-------------------------------------|
| 1 | Battery Level Indicator | 22 | Exposure Compensation Value* |
| 2 | Image Size | 23 | ISO Sensitivity |
| 3 | Aspect Ratio | 24 | Focus Mode * |
| 4 | Image Quality | 25 | Metering Mode |
| 5 | Folder numbering | 26 | White Balance (Filtering Effect) |
| 6 | File numbering | 27 | Drive Mode |
| 7 | Lock * | 28 | Color Mode (Toning Effect) |
| 8 | Mark * | 29 | Contrast * |
| 9 | Eye-Fi Transfer * | 30 | Sharpness * |
| 10 | RAW Development | 31 | Saturation * |
| 11 | Focusing Frame | 32 | Focal Length |
| 12 | File Size | 33 | Camera name |
| 13 | Sound Memo * | 34 | File Number / total files recorded |
| 14 | Overexposure Correction * | 35 | Date |
| 15 | Tone Control | 36 | Time |
| 16 | Auto Bracket * | 37 | Histogram (Brightness) |
| 17 | Flash Mode * | 38 | Histogram (Red) |
| 18 | Flash Exposure Compensation Value * | 39 | Histogram (Green) |
| 19 | Exposure Mode | 40 | Histogram (Blue) |
| 20 | Shutter Speed | | |
| 21 | F Number | | |

*If these features are set, the icon will be displayed.

WHILE IN IMAGE INFO SCREEN:

- Press the  button again to return to the original Single-Image View.
- Different images can be selected in Single-Image View by pressing  .
- Rotate the Rear Dial to see the previous or next images.



- It is possible to check Copyright Information (Photographer and Copyright) by pressing  button and switching it to Copyright Information screen.



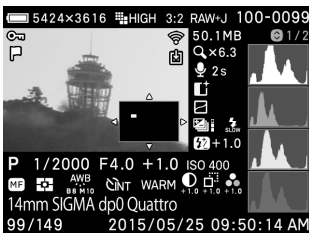

MAGNIFIED IMAGES IN IMAGE INFO SCREEN



While the Image Info Screen is displayed, it is possible to magnify the image by rotating the Front Dial to the  direction. It is possible to obtain detailed histogram information for a particular section of an image.

- For more information on the histogram see the next section.

While magnifying the image in the Image Info Screen:

- Press the   buttons to pan to another part of the image. (Histogram will update automatically to reflect the new values.)
- Rotate the Front Dial to the  position to increase magnification.
- Rotate the Front Dial to the  position to decrease magnification.
- Press  to cancel magnification and view the Image Info Screen for full image.
- Rotate the Rear Dial to see the previous or next pages.

HISTOGRAM

The histogram is a graph depicting the distribution of brightness values in the image for each of the three color channels (Red, Green, and Blue) (The histogram displayed in the Shooting Mode is the distribution of tones in the image). The horizontal axis shows the brightness level, with darker pixels towards the left side and brighter pixels toward the right. The vertical axis shows the proportion of pixels at each level of brightness.

By examining the histogram of the full image, you can gauge the overall exposure of that image. You can also use the histogram to determine if zoomed-in sections of an image are over or under exposed.



This histogram shows that the higher pixel values are never used in the image, indicating that the image is underexposed, and therefore will appear dark. In general, when the histogram is higher on the left side, the image is mostly composed of dark pixels, causing it to appear dark—either because the image is underexposed or because it is a dark scene such as night shot or sunset.



This histogram shows a fairly even distribution of pixel values, indicating that the image is well exposed, with good contrast. However, the histogram distribution of a well exposed image will vary greatly depending on the subject.



This histogram shows that many of the pixel values are at their brightness limit, indicating that some areas of the image may be blown out. In general, when the histogram runs off the right side, the image will have many white pixels—either because the image is overexposed or because it is a bright scene such as the beach or snow.

DELETING FILES

This section describes how to delete the files recorded on a card.

- In this chapter, "file" refers to still images.

DELETE A FILE WITH THE DELETE BUTTON



A single file that is displaying can be deleted by pressing the  button.

1

Select the file that you wish to delete.

2

Press the  and a confirmation dialog [**Delete current file?**] will be displayed.

3

To delete the file, select [**Yes**] by using the **<>** buttons and press the **OK** button. If you don't delete the file, select [**No**] by using the **<>** buttons and press the **OK** button.

WARNING !!

- If the file is locked, a confirmation dialog [**This file is locked.**] will come up and protect from deletion. If you wish to delete the file, it is necessary to unlock it first. (See P.106-108 for information on locking and unlocking files.)
- Images stored as RAW+JPEG, both the RAW and JPEG files will be deleted.

DELETE FILES FROM THE DELETE MENU

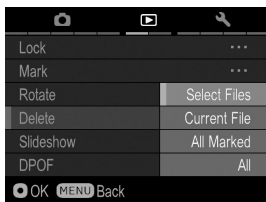

It is possible to delete a single file or multiple file from the Delete menu.

1

While the image is displayed, press the **MENU** button and open [**▶ Playback Menu**] (P.28) to select [**Delete**].

2

Select from the following options from the sub-menu.

| | |
|---------------------|---|
| Select Files | Select multiple files to delete. Use the <> buttons to display the file to delete, and the ⬡ buttons to display the 🗑 icon. Repeat the process to select files to delete. |
| Current File | Delete the currently selected file only. |
| All Marked | Delete all marked images on the card. (See P.108-110 for information on marking images.) |
| All | Delete all files on the card. |

3

Press the **OK** or > button to confirm your selection. A confirmation dialog will appear.

4

Select [**Yes**] by using the <> buttons and press the **OK** button to apply the setting. If you want to cancel to apply the setting, select [**No**] by using the <> buttons and press the **OK** button.

WARNING !!

- Locked files are not deleted. (See P.106-108 for information on locking files.)
- When [**Select Files**], [**All Marked**] or [**All**] is done, it may take time to finish them depending on the number of files in the card.

TIP

- Files except [**Select Files**] can be activated without viewing images.

OTHER REVIEWING FEATURES

This section explains how to use Slideshow, Lock, Mark, Rotate and so on.

LOCKING FILES

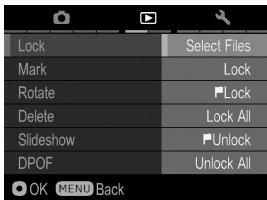

Locking protects files from being accidentally deleted.

CAUTION !!

- Locking does not prevent files from being erased when the card is formatted. Review card contents carefully before formatting.

TIP

- Locked files have a “read-only” status when viewed on a computer.

TO LOCK A SINGLE FILE

1

Display images to lock, press the **MENU** button and open [**▶ Playback Menu**] (P.28) to select [**Lock**].

2

Select [**Lock**] from sub menu.

3

Press the **OK** button or **▶** button.

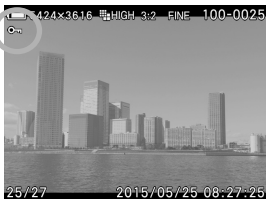

- A key icon  will appear in the file indicating that the file is locked.

TIP

- If the file is already locked, the menu item changes to **[Unlock]**.
- To unlock a locked file, select the locked file and follow the same steps as above.
- The **OK** button can be used as a shortcut key for locking files. (See P.113)

TO LOCK MULTIPLE FILES

1

Press the **MENU** button and open **[▶ Playback Menu]** (P.28) to select **[Lock]**.

2

Select from the following options from the sub-menu.

| | |
|---------------------|--|
| Select Files | Select multiple files to lock. Use the ◀▶ buttons to display the file to lock, and the ⏏ buttons to display 🔒 icon. Repeat the process to select files to lock. |
| 🚩 Lock | Lock all marked images on the card. (See P.108-110 for information on marking images.) |
| Lock All | Lock all files on the card. |

3

A confirmation dialog will be displayed by pressing the **OK** or **>** button.

4

Select **[Yes]** by using the **◀▶** buttons and press the **OK** button to apply the setting. If you want to cancel to apply the setting, select **[No]** by using the **◀▶** buttons and press the **OK** button.

- A key icon **🔒** will appear in all locked files.

WARNING !!

- When [Select Files], [Lock] or [Unlock] is done, it may take time to complete this depending on the number of files in the card.

TIP

- To unlock multiple files, select the [Unlock All] or [Unlock] in the Lock Menu.

MARKING IMAGES



Images can be marked for various reasons, such as to identify favorites, to select images for a Slideshow, or to select images to be deleted with the “All marked” menu item in the Delete Menu (P.104).

TIP

- Images marked on the camera will retain their marked status when viewed in **SIGMA Photo Pro**.

TO MARK A SINGLE IMAGE

1
Display images to mark, press the **MENU** button and open [▶ **Playback Menu**] (P.28) to select [**Mark**].

2
Select [**Mark**] from sub menu.

3

Press the **OK** or **>** button.

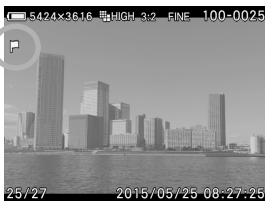

- A flag icon  will appear in the image indicating that the image is marked.

TIP

- If the image is already marked, the menu item changes to [**Unmark**].
- To unmark a marked image, select the marked image and follow the same steps as above.
- The **OK** button can be used as a shortcut key for marking images. (See P.113)

TO MARK MULTIPLE IMAGES

1

Press the **MENU** button and open [**Playback Menu**] (P.28) to select [**Mark**].

2

Select from the following options from the sub-menu.

| | |
|---------------------|---|
| Select Files | Select multiple files to mark. Use the <> buttons to display the file to mark, and the ◇ buttons to display  icon. Repeat the process to select files to mark. |
| Mark All | Mark all images on the card. |

3

A confirmation dialog will be displayed by pressing the **OK** or **>** button.

4

Select **[Yes]** by using the **<>** buttons to and press the **OK** button to apply the setting. If you want to cancel to apply the setting, please select **[No]** by using the **<>** buttons to and press the **OK** button.

- A flag icon  will appear in all marked images.

WARNING !!

- When **[Select Files]**, **[Mark All]** or **[Unmark All]** is done, it may take much time to finish them depending on the number of files in the card.

TIP

- Select **[Unmark All]** from the Mark Menu to unmark all marked images on the card.

ROTATING IMAGES

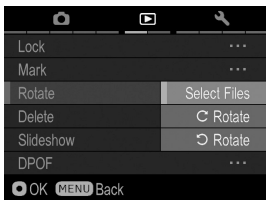

It is possible to rotate the displayed image.



TO ROTATE AN IMAGE

1

Display an image to rotate, press the **MENU** button and open **[▶ Playback Menu]** (P.28) to select **[Rotate]**.

2

Select from the following options from the sub-menu.

| | |
|---|---|
|  Rotate | Rotate the image 90 degrees to the right (clockwise). |
|  Rotate | Rotate the image 90 degrees to the left (counterclockwise). |

WARNING !!

- When [**Applied Rotate**] in [**▶ Playback Menu**] (P.28) is set to [**Off**], it is not possible to select the Rotate Menu.

TIP

- To rotate an image 180 degrees, rotate it twice in the same direction.
- To get an image back into its original orientation, rotate it in the opposite direction.
- The **OK** button can be used as a shortcut key for rotating images. (See P.113)
- Images rotated on the camera will be displayed in their rotated orientation in **SIGMA Photo Pro**.

TO ROTATE MULTIPLE IMAGES

1

Press the **MENU** button to open [**▶ Playback Menu**] (P.28), and select [**Rotate**].

2

Select [**Select Files**] from sub menu.

3

Use the **<>** buttons to display the file to rotate, and the **▲** button to rotate the image 90 degrees to the right, and the **▼** buttons to rotate the image 90 degrees to the left. Repeat the process to select files to rotate.

4

A confirmation dialog will be displayed by pressing the **OK** or **>** button.

5

Select **[Yes]** by using the **<>** buttons and press the **OK** button to apply the setting. If you want to cancel to apply the setting, select **[No]** by using the **<>** buttons and press the **OK** button.

EXPOSURE WARNING

It is possible to indicate the over-exposed areas by highlighting them in red.

Set to **[On]** from **[▶ Playback Menu]** (P.28) → **[Exposure Warning]**.

- The Exposure Warning is not indicated in the Quick Preview.

To dismiss the Exposure Warning, set to **[Off]** from **[▶ Playback Menu]** (P.28) → **[Exposure Warning]**.

TIP

- The **OK** button can be set as a shortcut button for Exposure Warning **[On/Off]** (Refer P.113).

OK BUTTON SHORTCUT



It is possible to allocate a function from the Playback Menu to the **OK** button. The allocated function can be changed by pressing the **OK** button.

The OK Button Shortcut can be set in [**▶ Playback Menu**] (P.28) → [**OK Button Settings**].

Available functions to allocate to the **OK button.**

| | |
|--------------------------------------|---|
| Lock | Lock the currently selected image by pressing the OK button. If the current image is already locked, the image will be unlocked. |
| Mark | Mark the currently selected image by pressing the OK button. If the current image is already marked, the image will be unmarked. |
| Exposure Warning | Each time the OK button is pressed, toggle the exposure warning on or off. |
| ↻ Rotate | Each time the OK button is pressed, rotate the currently selected image 90 degrees to the right (clockwise). |
| ↺ Rotate | Each time the OK button is pressed, rotate the currently selected image 90 degrees to the left (counterclockwise). |
| Image Magnification (Default) | Each time the OK button is pressed, toggle between zoomed-in view (10x) and original ratio. |

To dismiss the allocated function, set to [**None**] from [**▶ Playback Menu**] (P.28) → [**OK Button Settings**].

RECORDING SOUND MEMO

It is possible to record a sound memo for 30 seconds to a stored image, making it convenient to record the shooting situation by voice.

1

Set to **[On]** from **[▶ Playback Menu]** (P.28) → **[Sound Memo]**.

2

Close **[▶ Playback Menu]** by pressing the **MENU** button.

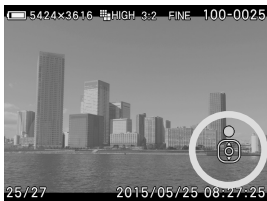

3

Press the **▲** button to start the recording.

- If the **▼** button is pressed during the recording, the recording will be terminated.
- Recording will be terminated automatically when 30 seconds has passed.

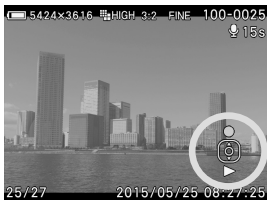

To play the recording sound memo, press the **▼** button. (See P.115 for instruction of Viewing Images With Sound.)

- Confirmation message for overwriting the sound memo is displayed by pressing the **▲** button when the image already has some sound. To overwrite the sound memo, use the **<>** buttons to select **[Yes]**, and press the **OK** button. To cancel, use the **<>** buttons to select **[No]**, and press the **OK** button.
- To turn off the sound memo function, set it to **[Off]** from **[▶ Playback Menu]** (P.28) → **[Sound Memo]**.

WARNING !!

- It is not possible to record sound memo if the card has little capacity.

VIEWING IMAGES WITH SOUND

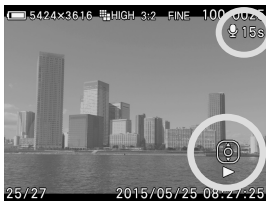

1

When the image with sound is selected during image review, the  Icon and the Control Icons are displayed on the color LCD monitor.

2

Press the  button to play the recorded sound.

Press the  button again to stop the sound.

WARNING !!

- It is not possible to play the recorded sound when the camera is in Zoomed-In View or Contact Sheet.

TIP

- If you want to change the volume of the recorded sound, it is possible to change the setting from [ **Camera Settings**] (P.28) → [**Sound Settings**] → [**Playback Volume**]. Please see [**Sound Settings**] in P.132 for more information.
- The sound recording (.WAV file) that is attached to the still image will be stored in the same folder and have the same file name as the image file. For example, the image file name will be SDIM0010.JPG and sound file name will be SDIM0010.WAV. When reviewing the files with your PC it is not possible to open still image and sound image at same time. Please open "WAV" file with dedicated software.

SHOWING A SLIDESHOW

All images on the card, or only selected images, can be shown in an automatic playback mode using the dp0 Quattro camera's Slideshow feature.

SLIDESHOW MENU

| | |
|---------------------------|--|
| All Images | Start an automated slideshow of all images on the card. |
| Locked Images | Start an automated slideshow of all locked images on the card. |
| Marked Images | Start an automated slideshow of all marked images on the card. |
| Slideshow Settings | It is possible to set the length of time that each picture will be displayed and the availability of Repeat. |

TO START A SLIDESHOW

1

Press the **MENU** button while displaying an image and open [ **Playback Menu**] (P.28) to select [**Slideshow**].

2

Select [**All Images**], [**Locked Images**] or [**Marked Images**] in the sub-menu.

3

The Slideshow starts by pressing the  or  button.

To terminate the slideshow, press the  button.

WARNING !!

- When [**Marked Images**] is selected, it may take time to start the Slideshow depending on the number of files to be displayed.

CHANGING SLIDESHOW SETTINGS

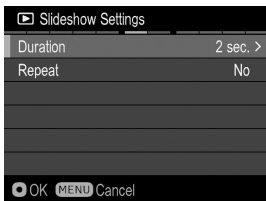

Select the [**Slideshow Settings**] in Slideshow Menu and then press the **OK** or **>** button to open the setting display.

SLIDESHOW SETTING MENU

| | | |
|-----------------|--|--|
| Duration | 2 sec. 5 sec. 10 sec. | Set the length of time that each image in a slideshow is displayed. |
| Repeat | No Yes | Set whether the slideshow loops continuously or stops on the last image. |

Duration

Select [**Duration**] using the **⬆** buttons, then select the desired number of seconds by pressing the **⬅** buttons.

Repeat

Select [**Repeat**] using the **⬆** buttons, then select [**No**] or [**Yes**] by pressing the **⬅** buttons.

Press **OK** button to confirm the Slideshow settings or **MENU** button to close the confirmation dialog without any change.

DPOF (DIGITAL PRINT ORDER FORMAT)

When printing images at a photo lab, it is possible to specify which photos and quantity to print in advance, using the DPOF menu. This is also available when making prints using a DPOF compatible printer.

WARNING !!

- In the case of RAW images (files with X3F extension), DPOF printing is not possible.

1

Press the **MENU** button to select [**DPOF**] in [**▶ Playback Menu**] (P.28) while displaying an image.

2

Select the desired option using the **OK** or **>** button.

DPOF MENU

| | |
|------------------------------|---|
| Select Files | Set the print quantity by pressing the ⬆ buttons. To set number of copies from multiple images, select the image that you wish to print by pressing the ⬅➡ buttons and then set the print quantity for each image by pressing the ⬆ buttons. |
| Select All | This option selects all still images on the card for printing. Set print quantity by pressing the ⬆ buttons. |
| Cancel All Selections | Reset all print quantity settings. |

3

A confirmation dialog will be displayed by pressing the **OK** or **>** button.

4

Select [**Yes**] by using the **⬅➡** buttons and press the **OK** button to apply the setting. If you want to cancel to apply the setting, select [**No**] by using the **⬅➡** buttons and press the **OK** button.

DEVELOPING RAW DATA INSIDE THE CAMERA

It is possible to develop RAW data inside the camera, and create a JPEG format image.

RAW development setting screen

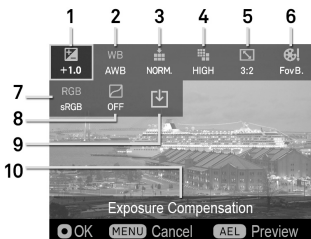

| | |
|----|---------------------------------|
| 1 | Exposure Compensation (P.78) |
| 2 | White Balance (P.64) |
| 3 | Image Quality (P.71) |
| 4 | Image Size (P.72) |
| 5 | Aspect Ratio (P.73) |
| 6 | Color Mode (P.81) |
| 7 | Color Space (P.85) |
| 8 | Tone Control (P.85) |
| 9 | Icon to start image development |
| 10 | Description of selected icon |

1

While displaying the RAW image, press the **MENU** button and open [**Playback Menu**] (P.28), then select [RAW Development].

2

In the sub menu, select the image to develop in RAW format from the following two methods;

| | |
|---------------------|--|
| Select Files | Display the picture to develop by pressing the <> buttons (when it is displaying 9 pictures over the screen, the <> button will appear instead), and confirm it with the OK button. <ul style="list-style-type: none">• It is possible to process [Selecting File] even when an image is not displayed in Step 1. |
| Current File | It displays the image selected at the Step 1 . <ul style="list-style-type: none">• It is not possible to select [Current File] when JPEG images are selected at the Step 1. |

• After selecting the image, the message [**Now Processing...**] will appear until it displays the RAW development setting screen.

3

In the RAW development setting screen, press the $\langle \diamond \rangle$ buttons to select an item, and confirm it by pressing the **OK** button.

- It is possible to set details of each option in White Balance (P.64) and Color Mode (P.81). Press the \square button to display the setting page. For further information, refer to the related sections in this instruction manual.

4

While checking the image, use front/rear Dials or $\langle \rangle$ buttons to change the adjustment value (or option). Then, confirm it by pressing the **OK** button.

5

Repeat Step **3** and **4** in case there are multiple items to change.

6

After finalizing the setting, select \downarrow (icon to start image development) and press the **OK** button.

7

Select [**Yes**] by using the $\langle \rangle$ buttons, and confirm it by pressing the **OK** button.

In order to stop the process, select [**No**] by using the $\langle \rangle$ buttons, and press the **OK** button.



- For the JPG images developed from RAW data, \downarrow mark will appear in the image.
- The File Number of the JPEG image developed from RAW data will become the next number following the final recorded file in the memory card.

WARNING !!

- In case there is insufficient space in the memory card, there will be a warning message and it is not possible to develop RAW file.
- It is recommended to use **SIGMA Photo Pro** for further detailed adjustment and image editing.

CHANGING OTHER SETTINGS

This section explains how to change the setting of basic camera operation to your desired settings.

FILE NUMBERING SYSTEM

Stored data is automatically assigned file numbers from 0001 to 9999. When data is being reviewed, the file number of each image is displayed in the right corner on the color LCD monitor (see P.97, 100). The file number is also incorporated into the filename of the image. The filename consists of “SDIM” followed by the 4-digit file number and extension. For example: image number 0023 will be stored in the file SDIM0023.X3F. All dp0 Quattro image files will be stored to ###SIGMA folder of the DCIM folder in the card.

- When [Adobe RGB] is selected from [📷 Capture Settings] (P.28) → [Color space], the filename will consist of “_SDI” instead of “SDIM”.
- File numbering can be continuous, or can be reset every time an empty card is detected. The File Numbering can be set from [📷 Camera Settings] (P.28) → [File Numbering].

FILE NUMBERING OPTIONS

| | |
|--------------------------------|---|
| Continuous (Default) | Numbering is continuous. The first file number assigned on an empty card will be one higher than the last assigned number. (If the inserted card contains dp0 Quattro images with file numbers greater than the last assigned number, file numbering will continue with one higher than the highest file number on the card.) |
| Auto Reset | Each time an empty card is inserted, or all images on the current card are deleted, the file number will reset to its default value of 0001. (If the inserted card already contains dp0 Quattro images, the file number will not be reset). |

WARNING !!

- When Folder numbering / File numbering is reached to “999-9999”, even if the card has the capacity, the message of [**Cannot allocate file or folder number.**] will be displayed and it is not possible to take pictures any more. Please check the File numbering in reviewing display. If the file number of “999-9999” exists in the card, please proceed as follow.
 1. Transfer all files in the card to your PC.
 2. Format the card.
 3. If the [**File Numbering**] is set to [**Continuous**], once set to [**Auto Reset**].
 4. If you usually set [**File numbering**] to [**Continuous**], set to [**Continuous**] once again.
- If you wish to continue to take pictures with any other card, please proceed it from step 3.

TO CHANGE FILE NAMES

File name of images can be selected from either “SDIM” or “DP0Q”.

Select the setting from [ **Camera Settings**] (P.28) → [**File Name**].

| | |
|-----------------------|-----------------------------------|
| SDIM (Default) | File name will be “SDIMxxxx.xxx”. |
| DP0Q | File name will be “DP0Qxxxx.xxx”. |

- The number in the file name will be continuous even after changing the setting from SDIM to DP0Q or vice versa.
- When [**Adobe RGB**] is selected from [ **Capture Settings**] (P.28) → [**Color space**], the file name will consist of “_SDI” instead of “SDIM”, and become “_P0Q” instead of “DP0Q”.

ATTACH COPYRIGHT INFORMATION

It is possible to save the [Photographer] and [Copyright] information in the Exif data.

- [Photographer] [Copyright]: Respectively, it is possible to enter up to 48 single-byte characters and symbols.

1

Select from  **Camera Settings**] (P.28) → **[Copyright Information]**.

2

In the Copyright Information screen, select either **[Photographer]** or **[Copyright Owner]** and follow the steps for **[Entering Information]** in the next page.



3

Once the relevant information has been entered, use the  buttons to scroll to **[Attach Copyright Information]** and select **[On]**. Copyright information will embed in each image from then on.

TIP

- It is possible to check the attached information in the Copyright Information screen (P.101).
- It is possible to check the attached information in the **[Image Information Window]** in **SIGMA Photo Pro** and other software compatible with Exif data.

WARNING !!

- Make sure the **[Attach Copyright Information]** is set to **[Off]** if the camera is being used by another photographer. It is recommended that the information in **[Photographer]** and **[Copyright Owner]** is deleted in such cases.
- We assume no responsibility whatsoever for any difficulties and/or damages resulting from the usage of copyright information.

ENTERING INFORMATION

Screen to enter the Photographer and Copyright Owner information



Entered information area



It is possible to move the cursor in the area using the front/rear dials.

Keyboard area

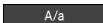
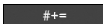

Move the cursor in this area using the  buttons.

1

Select the desired character in the Keyboard area, and press the  button to enter it.

| | |
|---|---|
|  | Switch the keyboard to alphabet. When the alphabet is displayed, it is possible to select capital and lowercase letters. |
|  | Switch the keyboard to symbols. |
|  | Insert a 1 character space. |

2

Select  and  to finalize the entered information. It will then go back to the previous screen.

- The **MENU** button will cancel the characters entered, and it goes back to the previous screen.

Deleting characters



Using the front/rear dials, place the cursor after the letters you wish to delete and press the **AEL** button.

CUSTOMIZE THE DISPLAY OF LCD MONITOR

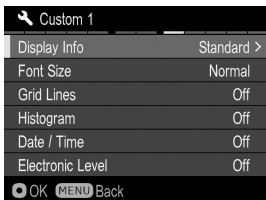
Size of icon displayed during shooting can be changed, or useful functions for photography can be added.



1

Select mode to customize from [ **Camera Settings**] (P.28) → [ **Mode Settings**].

2

Select [On] and press the > button.

3

Select items to change and press the > button.

TIP

- Unrequired display mode can be set to hide. Select unrequired mode from [ **Mode Settings**] and set them to [Off].

Display Info

Shooting information to display can be selected.

| | |
|-----------------|---|
| Off | Only the information at the bottom of the screen is displayed. |
| Minimum | Only the information at the bottom of the screen, the battery level and the maximum number of images to be taken are displayed. |
| Standard | Standard display |

Font Size

Font Size for shooting information can be selected.

| | |
|---------------|-------------------------|
| Normal | Display in normal size. |
| Large | Display in large size. |

Grid Lines

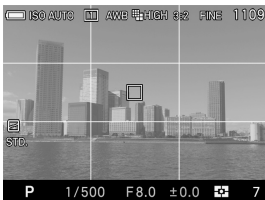

Grid Lines that is useful in determining composition can be displayed.

| | |
|---------------------|-------------------------------|
| Off | Grid Line Off |
| — 4 (Black) | 4 segments with a black line |
| — 9 (Black) | 9 segments with a black line |
| — 16 (Black) | 16 segments with a black line |
| — 4 (White) | 4 segments with a white line |
| — 9 (White) | 9 segments with a white line |
| — 16 (White) | 16 segments with a white line |

Histogram

Histogram that is useful in determining exposure can be displayed.

- Refer P.102 [**Histogram**] for further information on Histogram.

| | |
|------------|-------------|
| Off | No display. |
| On | Display. |

Date / Time

Date and Time can be displayed.

| | |
|--------------------|-----------------------------|
| Off | No display. |
| Date | Display Date only. |
| Time | Display Time only. |
| Date + Time | Display both Date and Time. |

Electronic Level

An Electronic level that is useful in determining composition can be displayed.

| | |
|------------|-------------|
| Off | No display. |
| On | Display. |

ELECTRONIC LEVEL

Camera's horizontal direction and vertical direction are displayed.



Vertical direction guide

Horizontal direction guide

- When the camera is horizontal or vertical, the guide becomes green.
- When shooting vertically, the display changes to one for vertical shooting.

WARNING !!

- Electronic level usually has error about $\pm 1^\circ$. The more it is tilted, the larger the error becomes, and in such case it does not work properly.
- When the camera is facing down, the Electronic level does not work properly.

ADJUSTMENT OF ELECTRONIC LEVEL

Electronic level's tilt can be adjusted.

1

Select from [ **Camera Settings**] (P.28) → [**Adjust Electronic Level**].

2

Place the camera on a horizontal surface, and press the  button.

- To reset, press the  button. The adjustment value returns to factory default.

CUSTOMIZING THE DIAL

The dial's functions or operating directions to set exposure, and the focus ring's operating directions can be customized.

SWITCH DIAL FUNCTIONS

The Front Dial and the Rear Dial are used for changing the aperture value, shutter speed and exposure compensation. It is possible to change the function of them for each Exposure Mode.

It is possible to set from [**Camera** Capture Settings] (P.28) → [**Switch Dial Functions**].

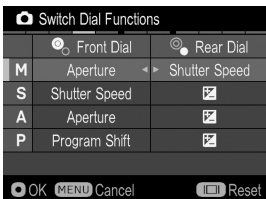

Select the desired Exposure Mode by pressing the button and change the function by using the button. To apply the setting, press the button.

- To reset to the default setting, please press the button and then press the button.

DIAL / MANUAL RING ROTATION



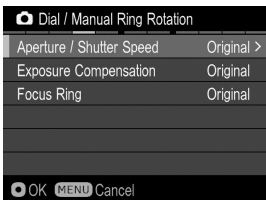

It is possible to reverse the Dial direction and Focus ring direction.

It is possible to set from [**Camera** Capture Settings] (P.28) → [**Dial / Manual Ring Rotation**].





Select the option you want to change by using the buttons. Then select [**Original**] or [**Reverse**] and press the button to apply the setting.



Aperture / Shutter speed

| | Aperture Value | Shutter Speed |
|------------------------------|--|---|
| Original (Default) | Open  Stop down | Slow  Fast |
| Reverse | Stop down  Open | Fast  Slow |

Exposure compensation

| | Exposure Compensation Value |
|------------------------------|--|
| Original (Default) | Under Exposure  Over Exposure |
| Reverse | Over Exposure  Under Exposure |

Focus Ring

| | Focus Position |
|------------------------------|---|
| Original (Default) | Close  Distant |
| Reverse | Distant  Close |

LCD OFF AND AUTO POWER OFF

The dp0 Quattro has [**LCD Off**] and [**Auto Power Off**] functions in order to conserve battery power. If not used for a predetermined amount of time, the color LCD monitor or power will be turned off automatically.

LCD Off

If not used for a predetermined amount of time, the backlight of the color LCD monitor will be turned off automatically. Although the color LCD monitor is turned off, the camera power remains ON, therefore, each button can be operated normally. It is possible to change to shooting mode, upon pressing the shutter button halfway.

Auto Power Off

If not used for a predetermined amount of time, the camera will be turned off automatically. While the camera is in Auto Power Off, each button will not function. It is necessary to press the Power switch to terminate Auto Power Off.

Set the Auto Power Off from [ **Camera Settings**] (P.28) → [**LCD Off**] and [**Auto Power Off**].

LCD Off Option

| |
|-------------------------|
| Off |
| 10 sec. |
| 30 sec. |
| 1 min. (Default) |
| 5 min. |
| 10 min. |

Auto Power Off Option

| |
|-------------------------|
| Off |
| 30 sec. |
| 1 min. |
| 5 min. (Default) |
| 10 min. |

TIP

- To disable LCD Off, set [**LCD Off**] to [**Off**].
- To disable Auto Power Off, set [**Auto Power Off**] to [**Off**].

WARNING !!

- It is not possible to set [**LCD Off**] for a longer time than [**Auto Power Off**]. For example, when [**LCD Off**] is set to [**5min.**] and [**Auto Power Off**] is set to [**1min.**], the [**LCD Off**] setting will be changed to [**1 min.**] automatically.

ECO MODE

ECO Mode saves battery usage by reducing the brightness of the LCD monitor and frame rate when the camera has not been used for 10 seconds.

Set to [**On**] from [ **Camera Settings**] (P.28) → [**ECO Mode**].

| | |
|----------------------|-----------------------|
| Off (Default) | Set to Standard Mode. |
| On | Set to ECO Mode. |

SOUND SETTINGS

This section explains settings about the Shutter Sound, Operation Sound, Sound Volume and Playback Volume.

These sound settings can be set from [ **Camera Settings**] (P.28) → [**Sound Setting**].

Shutter Sound

It is possible to set the Shutter Sound by setting to [**On**] or [**Off**].



- The default setting is [**On**].

Operation Sound

It is possible to set the Operation Sound when the focus is verified, alarm when the focus is not verified and operation sound of the self-timer by setting to [**On**] or [**Off**].



- The default setting is [**On**].

Sound Volume

It is possible to set the volume of Shutter Sound and Operation Sound from 0 to 5 in six levels. It is possible to down the volume by the  button and up by the  button.

- Setting of 0 does not make sound.
- The default setting is 3.

Playback Volume

It is possible to set the Playback Volume and Sound Memo volume from 0 to 5 in six levels. It is possible to reduce the volume by pressing the  button and increase the volume by pressing the  button.

- Setting of 0 does not make sound.
- The default setting is 3.

RESET TO THE DEFAULTS

It is possible to reset the settings to the defaults.

It is possible to reset settings to defaults from [ **Camera Settings**] (P.28) → [**Reset Settings**].

Reset all settings of [ **Capture Settings**] (Blue tab) to the defaults.

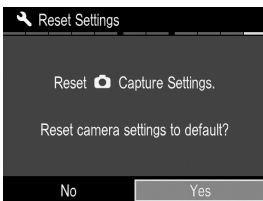

In [Reset Settings] menu, Select [Yes] by pressing the <> button and press the  button.

To cancel the reset settings, select [No] by pressing the <> button and press the  button.

If you want to reset all the camera settings, including other settings, you will have to reset the camera to factory defaults. In [**Reset Settings**] menu, press  to show the message [**Reset all camera settings to factory defaults?**].

To reset all camera settings to factory defaults, please select [**Yes**] by pressing the <> buttons and press the  button.

To cancel the reset settings, select [**No**] by pressing the <> buttons and press the  button.

CONNECTING TO A COMPUTER

CONNECTING YOUR CAMERA TO A COMPUTER

The dp0 Quattro camera can be connected directly to a computer using the provided USB cable. Make sure that the camera is off before connecting it to the computer. Data transfer rates will vary depending on the computer and operating system used. For further information, please refer to Help within **SIGMA Photo Pro**.

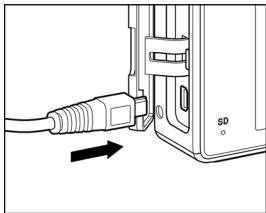

1

Turn the computer on.

2

Connect your camera to a computer with the provided USB cable.

WARNING!!

- Please ensure your computer is not in sleep mode whilst your camera connects to the computer. It may cause the data to be lost or damaged.
- Do not connect another USB cable to the computer while your camera is connecting to the computer. It may cause the data to be lost or damaged.
- Please use only the USB cable supplied with your camera.
- The shutter button and color LCD monitor will be disabled while the camera is connected to the computer via a USB cable.
- The Auto Power Off function does not work while connecting the USB cable.

REFERENCE

This section introduces optional accessories, and explains specifications of the camera.

OPTIONAL ACCESSORIES

VIEW FINDER VF-51

This high performance Albada inversed Galilean type Finder mounts on the hot shoe. It offers a framing guide for deciding the composition without the color LCD monitor and accurate framing unaffected by external light condition.

LCD VIEW FINDER LVF-01

By attaching it to the LCD display of the dp Quattro cameras, the LCD viewfinder cuts off outside light. It magnifies the LCD display 2.5 times and allows photographers to check the focusing more easily.

BASE GRIP BG-11

When it is attached to the camera's tripod socket on the bottom surface of the camera, it allows handgrip-style shooting.

CAMERA CASE HC-21

This jacket type camera case can be attached to the camera while photographing. It perfectly fits the camera, which improves the usability of the camera.

AC ADAPTER SAC-6

This is used to provide a constant electricity supply and is recommended when taking indoor shots or connecting the camera to your computer to transfer data. (DC Connector CN-21 is included with this camera to connect the AC adapter to the computer.) (P.138)

CAMERA BAG CB-31

The camera bag dedicated for the SIGMA dp Quattro is a single shoulder type and convenient for carrying the camera. It can store three dp Quattro cameras.

CABLE RELEASE SWITCH CR-31

This cable release allows releasing the shutter without touching the camera by connecting it to camera USB terminal. It is useful when attaching the camera to a tripod, and releasing the shutter from a distance, or slow shutter. (Cable length: Approximately 1m)

USING A HOME POWER SUPPLY

(sold separately)

You can power the camera from a wall outlet using the provided AC Adapter SAC-6 and DC Connector CN-21. When using your camera for an extended period of time, reviewing the pictures or connecting the camera to a computer, we recommend that you operate the camera from a household power outlet.

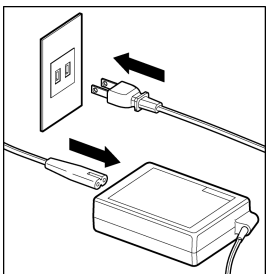

1

Connect the AC cable to the AC adapter.

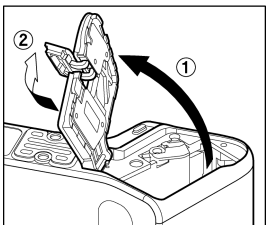

2

Open the Battery Cover, and open the DC connector cover as shown in the illustration.

Do not pull too hard on the DC connector cover as it may come away from camera body.

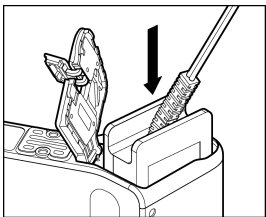

3

Insert the DC connector as shown in the illustration until it is locks into place.

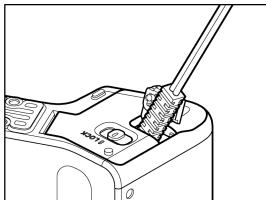

4

Close the Battery Cover carefully so as not to pinch the DC connector cable.

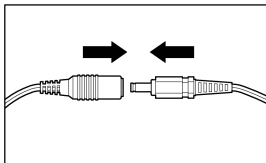

5

Connect the plug of the AC adapter and jack of the DC connector.

WARNING!!

- While the Busy Lamp is on, please do not open the Battery Cover or Card Cover. By doing so, the camera will turn off and result in data loss. This could also cause damage to the camera and/or memory card.
- When you have finished using the camera, please turn off the camera and disconnect the plug from the wall socket.

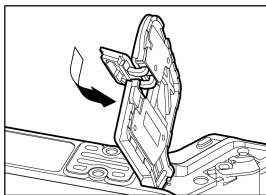

After taking the DC connector off from the camera body, close the DC connector cover as shown in the illustration.

MAINTENANCE

- Do not use chemicals or other cleaning agents such as thinners or benzene for cleaning the camera and lens. Use a clean, soft cloth and blower to clean the camera and lens. Lens cleaners can be used for removing fingerprints.
- Do not lubricate the camera.
- Use a blower to remove dust and dirt from the color LCD monitor. To remove fingerprints or other stains from the LCD monitor, wipe the surface gently with a soft, clean cloth. Do not apply excessive force, as this could damage the LCD monitor.

HOW TO STORE THE CAMERA

- If you intend to store the camera for a long time, remove the battery.
- To avoid growth of fungus, store the camera and lens in a dry, cool and ventilated place, with a drying agent such as silica gel. Keep your equipment away from chemicals.

NOTE ON THE TFT COLOR LCD MONITOR

- A few pixels may always be lit or may never light on the LCD monitor. This is not a failure or malfunction. Images recorded with the camera will not be affected.
- Because of the normal physical characteristics of the liquid crystal, the reaction of the display may become slow at low temperatures. At high temperatures, the display may become dark, but it will return to normal at room temperature.

TROUBLESHOOTING

If you have a problem with your camera or cannot take good pictures, consult the list below as you check the camera before requesting repairs.

Nothing is displayed on the color LCD monitor.

Battery is exhausted.

- ▶ Replace the battery. (P.21 - 24)

LCD Monitor is set to OFF mode.

- ▶ Press the  button to display the color LCD monitor. (P.36)

Camera is in LCD Off mode.

- ▶ Press the shutter button “half-way” or any other button. (P.130)

The shutter does not release.

The camera is busy writing to the card.

- ▶ Please wait until the card busy light goes off.

Card is full.

- ▶ Insert a new card or delete unwanted images. (P.103 - 104)

Autofocus does not operate.

Focusing mode is set to MF.

- ▶ Change the focusing mode by pressing the Focus mode button. (P.50)

When the [**Half-pressed AF-ON**] is set as [**Off**].

- ▶ Please select [**On**] in the [**Half-pressed AF-ON**] setting.(P.56)

The camera has turned off automatically.

Auto Power Off is activated.

- ▶ The Auto Power Off function is set in order to conserve battery power. If it is inconvenient, please set the Auto Power Off to “Off”. (P.130)

Cannot shoot or store images.

Card is full

- ▶ Insert a new card or delete unwanted images. (P.103 - 104)

Battery is exhausted.

- ▶ Replace the battery. (P.21 - 24)

The write protection switch is in the 'LOCK' position.

- ▶ Please unlock the write protection switch on the card. (P.11)

Image data on the card is corrupted.

- ▶ If important data remains in the card after transferring it to your PC, please format the card. (P.40)

Difficulty seeing the images on the color LCD monitor.

Dust or dirt has adhered to the color LCD monitor.

- ▶ Clean the color LCD monitor with a blower or eyeglass cloth. (P.140)

The color LCD monitor is worn out.

- ▶ Please consult the retailer from which you purchased the camera or contact the nearest Sigma Service Center.

Pictures are coming out blurred

AF may not be activated when the shutter was pressed.

- ▶ Press the shutter button "half-way" and press it after the focusing point is illuminated in green. (P.50)

Focusing mode is set to MF.

- ▶ Change the focusing mode by pressing the Focus mode button. (P.50)

Camera shake is occurred.

- ▶ Use the flashguns or tripod. (P.88)

White or colored dots and haze appear on a part of the image.

Due to the camera facing a strong light source, ghosting and flare appear on the image.

- ▶ Strong light source may cause ghosting and flare. Changing the composition or aperture and additionally attaching the lens hood will help minimize the extraneous light from diagonal directions.(P.20)

Keeping Overexposure Correction [**On**].

- ▶ Depending on light conditions, it cannot be adequately adjusted even with Overexposure Correction, which causes tinting on a part of the subject. In this case, please turn Overexposure Correction [**Off**].(P.84)

Cannot delete images.

Images may be locked.

- ▶ Unlock the images. (P.106 - 108)

The write protection switch is in the 'LOCK' position.

- ▶ Please unlock the write protection switch on the card. (P.11)

Incorrect date and time is shown.

Date and time setting may be incorrect.

- ▶ Enter the correct date and time in the Set-up Menu. (P.26)

Cannot play-back sound

Sound volume is set 0.

- ▶ The Sound Volume can be set from [ **Camera Settings**] (P.28) → [**Sound Settings**] → [**Sound Volume**]. (P.132)

SPECIFICATIONS

| | |
|--|--|
| Image Sensor | FOVEON X3 Direct Image Sensor (CMOS) |
| Image Sensor Size | 23.5 × 15.7mm |
| Color Photo Detectors | Effective Pixels : 29MP (T:5424×3616, M:2712×1808, B:2712×1808) Total Pixels : 33MP |
| Aspect Ratio | 3:2 (21:9, 16:9, 4:3, 7:6, 1:1) |
| Lens | 14mm (35mm equivalent focal length : 21mm) |
| Lens F number | F4 ~ F22 |
| Lens Construction | 8 Groups, 11 Elements |
| Shooting Range | 18 cm ~ ∞, LIMIT Mode (It is possible to choose Macro, Portrait and Scenery.) |
| Magnification | 1:7.8 |
| Filter Size | 58mm |
| Storage Media | SD Card, SDHC Card, SDXC Card |
| Recording Format | Exif 2.3, DCF 2.0, DPOF |
| File Format | Lossless compression RAW Data (14-bit), JPEG (Exif 2.3), RAW+JPEG |
| Image size (3:2) (Number of Pixels) | SUPER-HIGH(JPEG) : 7680 x 5120, HIGH : 5424 x 3616, LOW : 2704 x 1808 S-LO(JPEG) : 1920 x 1280 |
| Image Quality | RAW, JPEG (Fine, Normal, Basic), RAW+JPEG(Fine) |
| White Balance | 10 types (Auto, Auto (Lighting Source Priority), Daylight, Shade, Overcast, Incandescent, Fluorescent, Color Temperature, Flash, Custom) |
| Color Mode | 11 types (Standard, Vivid, Neutral, Portrait, Landscape, Cinema, Sunset Red, Forest Green, FOV Classic Blue, FOV Classic Yellow, Monochrome) |
| ISO Sensitivity | ISO100~6400 (1/3 steps for appropriate sensitivity) AUTO: Upper limit, Lower limit setting is possible between ISO 100 ~ ISO 6400.(When using with flash, it changes depending on the low limit setting.) |
| Auto Focus | Contrast Detection Type |

| | |
|-------------------------|---|
| AF Point | 9 points select mode, Free move mode (It is possible to change the size of Focus Frame to Spot, Regular and Large.), Face Detection AF Mode |
| Focus Lock | Shutter release halfway-down position (AF lock can be done by AE lock button from menu setting) |
| Manual Focus | Focus Ring type |
| Metering System | Evaluative metering, Center-Weighted Average Metering, Spot metering |
| Exposure Control System | (P) Program AE, (S) Shutter Priority AE,(A) Aperture Priority AE, (M) Manual |
| Exposure Compensation | ±3EV (1/3 stop increments) |
| AE Lock | AE lock button |
| Auto Bracketing | Appropriate, under, over; 1/3EV steps up to ±3EV for appropriate exposure |
| Shutter Speed | 1/2000* - 30sec. (*Depending on the aperture value, shutter speed changes) |
| Flash Mode | Forced Flash, Red-Eye Reduction Flash,Slow Synchro Mode |
| External Flash Sync. | Hotshoe (X Sync. Contact) |
| Drive Modes | Single, Continuous, Self Timer (2sec. /10sec.)Interval timer |
| LCD Monitor | approx. 920,000 pixels, 3.0 inches TFT color LCD monitor |
| LCD Monitor Language | English / Japanese / German / French / Spanish / Italian / Simplified Chinese / Traditional Chinese / Korean / Russian / Dutch / Polish / Portuguese / Danish / Swedish / Norwegian / Finnish |
| Interface | USB (USB2.0) / Cable Release Switch |
| Power | Li-ion Battery BP-51, AC Adapter SAC-6 (with DC Connector CN-21) (Optional) |
| Battery Life | Approx. 200 (+25°C) |
| Dimensions | 161.4mm/6.4"(W) × 67mm /2.6"(H) × 126mm/5.0"(D) |
| Weight | 500g / 17.6oz (without battery and card) |

SIGMA dp0 Quattro
FC Tested To Comply
With FCC Standards
FOR HOME OR OFFICE USE

SIGMA CORPORATION OF AMERICA
15 Fleetwood Court, Ronkonkoma, NY 11779, U.S.A.
TEL: 631 585 1144

This device complies with Part 15 of the FCC Rules. Operation is subject to the following two conditions: (1) This device may not cause harmful interference, and (2) this device must accept any interference received, including interference that may cause undesired operation.

For customers in the U.S.A.

Federal Communications Commission (FCC) Radio Frequency Interference Statement

This equipment has been tested and found to comply with the limits for class B digital devices, pursuant to Part 15 of the FCC Rules. These limits are designed to provide reasonable protection against harmful interference in a residential installation. This equipment generates, uses and can radiate radio frequency energy and, if not installed and used in accordance with the instructions, may cause harmful interference to radio communications. However, there is no guarantee that interference will not occur in a particular installation. If this equipment does cause harmful interference to radio or television reception, which can be determined by turning the equipment off and on, the user is encouraged to try to correct the interference by one or more of the following measures:

- Reorient or relocate the receiving antenna.
- Increase the separation between the equipment and receiver.
- Connect the equipment into an outlet on a circuit different from that to which the receiver is connected.
- Consult the dealer or an experienced radio/TV technician for help.

Use of interface cable is required to comply with class B limits in Subpart B of Part 15 of FCC Rules.

Any changes or modifications to this equipment not specified in this manual may void your warranty.

For customers in the Canada

This Class B digital apparatus complies with Canadian ICES-003.

Cet appareil numérique de la classe B est conforme à la norme NMB-003 du Canada.



This mark shows that the construction of the product is double-insulated.
Cette marque indique que la construction du produit a une double isolation.

CE The CE Mark is a Directive conformity mark of the European Community (EC).

SIGMA (Deutschland) GmbH

Carl Zeiss Str. 10/2, D 63322 Roedermark, Germany

Verkauf: 01805-90 90 85-0 Service: 01805-90 90 85-85 Fax(Service): 01805-90 90 85-35

SIGMA CORPORATION

2-4-16 Kurigi, Asao-ku, Kawasaki-shi, Kanagawa 215-8530 Japan

Phone : 044-989-7430 Fax : 044-989-7451