

# PROFXv3 SERIES

## OWNER'S MANUAL

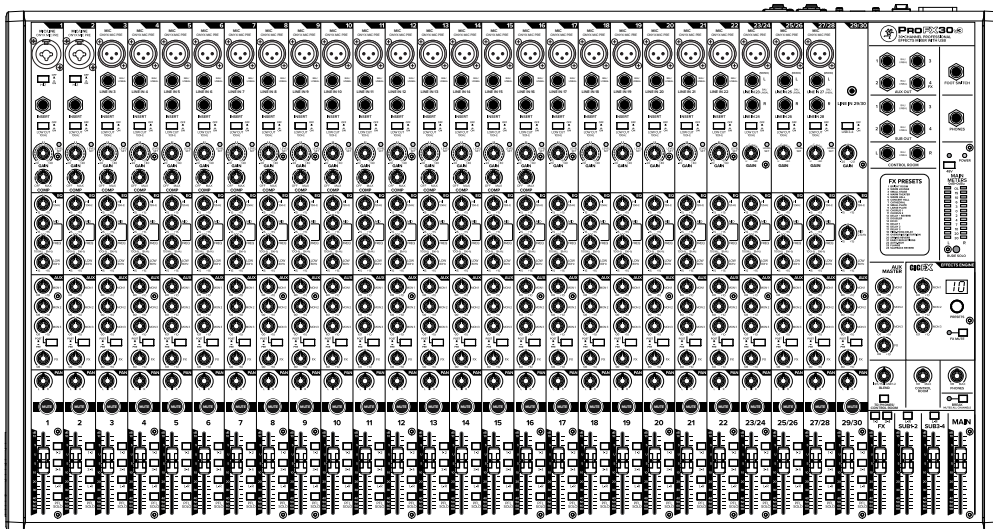
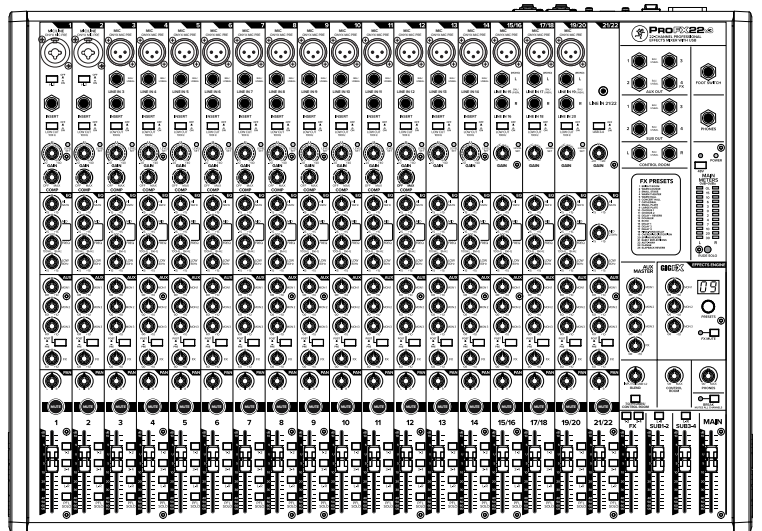
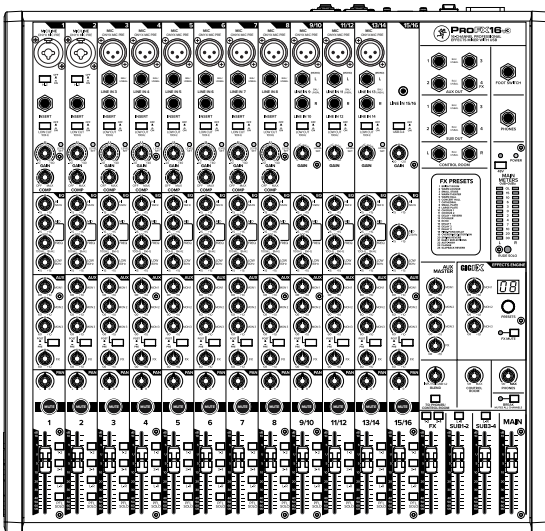
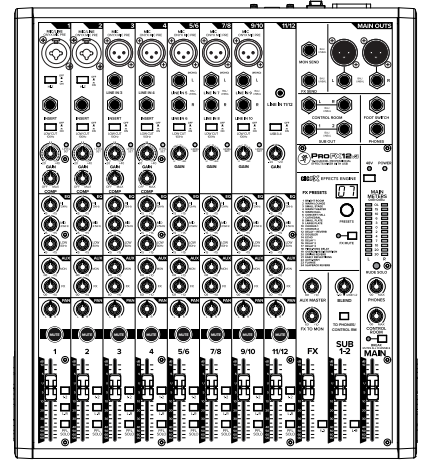
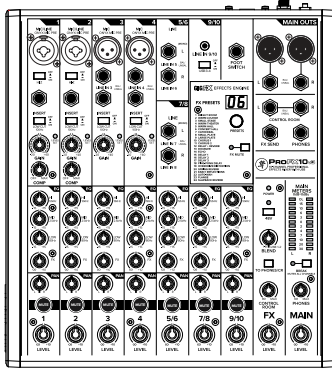
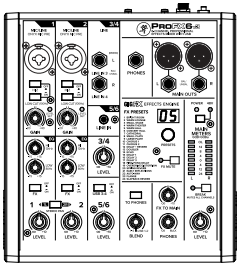

# Important Safety Instructions

1. Read these instructions.
2. Keep these instructions.
3. Heed all warnings.
4. Follow all instructions.
5. Do not use this apparatus near water.
6. Clean only with a dry cloth.
7. Do not block any ventilation openings. Install in accordance with the manufacturer's instructions.
8. Do not install near any heat sources such as radiators, heat registers, stoves, or other apparatus (including amplifiers) that produce heat.
9. No naked flame sources, such as lighted candles, should be placed on the apparatus.
10. Do not defeat the safety purpose of the polarized or grounding-type plug. A polarized plug has two blades with one wider than the other. A grounding-type plug has two blades and a third grounding prong. The wide blade or the third prong are provided for your safety. If the provided plug does not fit into your outlet, consult an electrician for replacement of the obsolete outlet.
11. Protect the power cord from being walked on or pinched particularly at plugs, convenience receptacles, and the point where they exit from the apparatus.
12. Only use attachments/accessories specified by the manufacturer.
13. Use only with a cart, stand, tripod, bracket, or table specified by the manufacturer, or sold with the apparatus. When a cart is used, use caution when moving the cart/apparatus combination to avoid injury from tip-over.
14. Unplug this apparatus during lightning storms or when unused for long periods of time.
15. Refer all servicing to qualified service personnel. Servicing is required when the apparatus has been damaged in any way, such as power-supply cord or plug is damaged, liquid has been spilled or objects have fallen into the apparatus, the apparatus has been exposed to rain or moisture, does not operate normally, or has been dropped.
16. This apparatus shall not be exposed to dripping or splashing, and no object filled with liquids, such as vases or beer glasses, shall be placed on the apparatus.
17. Do not overload wall outlets and extension cords as this can result in a risk of fire or electric shock.



**CAUTION**

**RISK OF ELECTRIC SHOCK! DO NOT OPEN!**

CAUTION: TO REDUCE THE RISK OF ELECTRIC SHOCK DO NOT REMOVE COVER (OR BACK). NO USER-SERVICEABLE PARTS INSIDE. REFER SERVICING TO QUALIFIED PERSONNEL.

The lightning flash with arrowhead symbol within an equilateral triangle is intended to alert the user to the presence of uninsulated "dangerous voltage" within the product's enclosure, that may be of significant magnitude to constitute a risk of electric shock to persons.

The exclamation point within an equilateral triangle is intended to alert the user of the presence of important operating and maintaining (servicing) instructions in the literature accompanying the appliance.

18. This apparatus has been designed with Class-I construction and must be connected to a mains socket outlet with a protective earthing connection (the third grounding prong).
19. This apparatus has been equipped with a rocker-style AC mains power switch. This switch is located on the rear panel and should remain readily accessible to the user.
20. The MAINS plug or an appliance coupler is used as the disconnect device, so the disconnect device shall remain readily operable.
21. The use of apparatus is in tropical and/or moderate climates.

**WARNING** — To reduce the risk of fire or electric shock, do not expose this apparatus to rain or moisture.

Laitte on liitettävä suojakoskettimilla varustettuun pistorasiaan.  
 Apparater må tilkoples jordat stikkontakt.  
 Apparaten skall anslutas till jordat uttag.

**Correct disposal of this product:** This symbol indicates that this product should not be disposed of with your household waste, according to the WEEE directive (2012/19/EU) and your national law. This product should be handed over to an authorized collection site for recycling waste electrical and electronic equipment (EEE). Improper handling of this type of waste could have a possible negative impact on the environment and human health due to potentially hazardous substances that are generally associated with EEE. At the same time, your cooperation in the correct disposal of this product will contribute to the effective usage of natural resources. For more information about where you can drop off your waste equipment for recycling, please contact your local city office, waste authority, or your household waste disposal service.

22. **NOTE:** This equipment has been tested and found to comply with the limits for a Class B digital device, pursuant to part 15 of the FCC Rules. These limits are designed to provide reasonable protection against harmful interference in a residential installation. This equipment generates, uses, and can radiate radio frequency energy and, if not installed and used in accordance with the instructions, may cause harmful interference to radio communications. However, there is no guarantee that interference will not occur in a particular installation. If this equipment does cause harmful interference to radio or television reception, which can be determined by turning the equipment off and on, the user is encouraged to try to correct the interference by one or more of the following measures:
  - Reorient or relocate the receiving antenna.
  - Increase the separation between the equipment and the receiver.
  - Connect the equipment into an outlet on a circuit different from that to which the receiver is connected.
  - Consult the dealer or an experienced radio/TV technician for help.

**CAUTION:** Changes or modifications to this device not expressly approved by LOUD Audio, LLC could void the user's authority to operate the equipment under FCC rules.

23. This device complies with FCC radiation exposure limits set forth for an uncontrolled environment. This device should be installed and operated with minimum distance 20cm between the radiator & your body.
24. This apparatus does not exceed the Class A/Class B (whichever is applicable) limits for radio noise emissions from digital apparatus as set out in the radio interference regulations of the Canadian Department of Communications.

**ATTENTION** — *Le présent appareil numérique n'émet pas de bruits radioélectriques dépassant les limites applicables aux appareils numériques de class A/de class B (selon le cas) prescrites dans le règlement sur le brouillage radioélectrique édicté par les ministere des communications du Canada.*

25. This device complies with Industry Canada's licence-exempt RSSs. Operation is subject to the following two conditions:
  - (1) this device may not cause interference, and
  - (2) this device must accept any interference, including interference that may cause undesired operation of the device.

Le présent appareil est conforme aux CNR d'Industrie Canada applicables aux appareils radio exempts de licence. L'exploitation est autorisée aux deux conditions suivantes:

- (1) l'appareil ne doit pas produire de brouillage, et
- (2) l'utilisateur de l'appareil doit accepter tout brouillage radioélectrique subi, même si le brouillage est susceptible d'en compromettre le fonctionnement.

26. Exposure to extremely high noise levels may cause permanent hearing loss. Individuals vary considerably in susceptibility to noise-induced hearing loss, but nearly everyone will lose some hearing if exposed to sufficiently intense noise for a period of time. The U.S. Government's Occupational Safety and Health Administration (OSHA) has specified the permissible noise level exposures shown in the following chart.

According to OSHA, any exposure in excess of these permissible limits could result in some hearing loss. To ensure against potentially dangerous exposure to high sound pressure levels, it is recommended that all persons exposed to equipment capable of producing high sound pressure levels use hearing protectors while the equipment is in operation. Ear plugs or protectors in the ear canals or over the ears must be worn when operating the equipment in order to prevent permanent hearing loss if exposure is in excess of the limits set forth here:

Duration, per day in hours	Sound Level dBA, Slow Response	Typical Example
8	90	Duo in small club
6	92	
4	95	Subway Train
3	97	
2	100	Very loud classical music
1.5	102	
1	105	Chaz screaming at Troy about deadlines
0.5	110	
0.25 or less	115	Loudest parts at a rock concert

# Contents

- Important Safety Instructions..... 2
- Contents / Features ..... 3
- Introduction / Getting Started..... 4
- Hookup Diagrams ..... 5
  
- ProFXv3 Rear Panel Features ..... 7
  - 1. Power Connection ..... 7
  - 2. Power Switch ..... 7
  - 3. USB Input / Output ..... 7
  - 4. Main Outputs ..... 8
  
- ProFXv3 Front Panel Features ..... 9
  - 5. XLR and 1/4" Combo Inputs [Chs. 1 and 2]..... 9
  - 6. Line / Hi-Z Switches [Chs. 1 and 2]..... 9
  - 7. Mic Ins ..... 10
  - 8. Line Ins..... 10
  - 9. Stereo Line Inputs..... 10
  - 10. 1/8" Stereo Input..... 10
  - 11. Insert Jacks..... 11
  - 12. Low Cut Switches ..... 11
  - 13. Gain Knobs and Level Set LEDs ..... 11
  - 14. Compressor Knobs ..... 12
  - 15. Hi EQ Knobs..... 13
  - 16. Mid EQ Knobs..... 13
  - 17. Mid Freq Knobs..... 13
  - 18. Mid EQ Knobs ..... 13
  - 19. Low EQ Knobs ..... 13
  - 20. Aux Mon Knobs ..... 14
  - 21. Pre-Fader Switches ..... 14
  - 22. Aux FX Knobs..... 14
  - FX Switches (Chs. 1-2) [ProFX6v3] ..... 14
  - Stereo Pan Switch (Chs. 1-2) [ProFX6v3] ..... 14
  - 23. Pan Knobs ..... 14
  - 24. Mute Switches..... 15
  - 25. Assign Switches ..... 15
  - 26. PFL Solo Switches..... 15
  - 27. Channel Faders ..... 15
  - 28. USB Switch..... 15
  - 29. Aux Out / Mon Send ..... 16
  - 30. FX Send ..... 16
  - 31. FX Footswitch..... 16
  - 32. Sub Out Jacks ..... 17
  - 33. Control Room Out Jacks..... 17
  - 34. Phones Out Jack ..... 17
  - 35. Pencil Sharpener..... 17
  - 36. 48V Phantom Power Switch..... 18
  - 37. Power LED ..... 18
  - 38. Main Meters ..... 18
  - 39. Rude Solo LED ..... 18
  - 40. Aux Master Knobs..... 19
  - 41. FX to Mon Knobs..... 19
  - 42. Preset Selector..... 19
  - 43. Preset Display ..... 19
  - 44. FX Mute Switch and LED ..... 19
  - 45. Theremin..... 20
  - 46. Blend Knob..... 20
  - 47. To Phones / Control Room Switch ..... 20
  - 48. Control Room Knob ..... 20
  - 49. Phones Knob..... 20
  - 50. Break Switch and LED ..... 20
  - 51. Break Switch and LED ..... 21
  - 52. FX to Sub Switches ..... 21
  - 53. Sub 1-4 Faders..... 21
  - 54. Sub Assign Switches..... 21
  - 55. Main Mix Fader..... 21
  
- Appendix A: Service Information ..... 22
- Appendix B: Technical Information ..... 24
  - ProFXv3 Dimensions ..... 26
  - ProFXv3 Block Diagrams ..... 30
  - ProFXv3 Track Sheets..... 35
- Appendix C: Table of Effects Presets ..... 40
  
- Limited Warranty ..... 41

# Features

## Mix / Record / Create

- We've taken our most popular mixer series and given it major upgrades that will take your sound quality to the next level
- Perfect for live sound, home recording, content creation, and live streaming
- With models available in 6, 10, 12, 16, 22, and 30 channels, you can get the perfect mixer for your application or go big and be ready when the need comes

## Renowned Onyx Mic Preamps

- With up to 60 dB of gain and ultra-low noise, ProFXv3 mixers allow you to sound better than ever
- Perfect for microphones popular with content creators that require high-gain preamps

## High-Resolution GigFX™ Effects Engine

- With 24 different FX options, from reverbs to delays, adding some drama to your sound is easy easy... easy..... easy..... easy (Delay, get it?)

## 24-Bit / 192kHz 2x4 USB Recording Interface

- Lay down your tracks in incredible 24-Bit / 192kHz quality for the cleanest recordings possible
- 2x4 USB I/O allows you to create two custom mixes on your computer to send back into your ProFXv3 mixer, great for situations when you need to monitor specific tracks during playback in addition to the full mix

## Effortless Latency-Free Monitoring

- With a single knob, you can blend between monitoring your computer's output and a direct feed from the mixer
- Great for recording overdubs alongside a pre-recorded track

## Single-Knob Compression \*

- Keep your input levels in check and get maximum channel headroom with the quick turn of a knob
- Great for giving vocals the finishing touch in live, recording, and even streaming applications

## Record and Produce Like a Pro

- ProTools® | First and Waveform™ OEM professional software and plugin packages included
- The Musician Collection for ProTools | First includes 23 plugins like BBD Delay, Eleven Lite, 304 EQ, and 304C Compressor
- The DAW Essentials™ Bundle for Waveform™ OEM includes 16 powerful plugins like Equaliser, Compressor, Reverber8, and Limiter

## Signature Rugged Design

- Legendary Built-Like-A-Tank™ design
- Solid steel chassis protects your investment
- Tough ABS side protection

## Accessories

- Protective dust cover (sold separately) \*
- Protective bag (sold separately) \*\*

\* Not available for ProFX6v3

\*\* Not available for ProFX30v3



Like us



Follow us



Watch our dang videos

Part No. SW1278 Rev. A 09/19

©2019 LOUD Audio, LLC. All Rights Reserved.

## Introduction

Mackie ProFXv3 Series Effects Mixers with USB are the ultimate affordable solution for live sound, home recording, and content creators available in 6, 10, 12, 16, 22, and 30 channels.

Now with our renowned Onyx™ mic preamps that offer 60 dB of headroom, everything from gain hungry mics to guitars will sound better than ever. And you can keep it all in check with easy single-knob compression.

The new GigFX™ effects engine offers 24 built-in FX for even more options for adding the finishing touch.

Record your tracks in 24-Bit/192kHz quality with 2x4 USB I/O with zero-latency hardware monitoring for easy overdubs. Both ProTools® | First and Waveform™ OEM recording software/plugin packages are included.

### How to Use This Manual:

After this introduction, a getting started guide will help you get things set up fast. The hookup diagrams show some typical setups, while the remaining sections provide details of the ProFXv3 Series mixers.



This icon marks information that is critically important or unique to ProFXv3. For your own good, read and remember them.



This icon leads you to in-depth explanations of features and practical tips. They usually have some valuable nuggets of information.



This icon draws attention to certain features and functions relating to the usage of ProFXv3.

### Things to Remember:

- Never listen to loud music for prolonged periods. Please see the Safety Instructions on page 2 for information on hearing protection.
- Save the shipping box and packing materials! You may need them someday. Besides, the cats will love playing in them and jumping out at you unexpectedly. Remember to pretend like you are surprised!
- Save your sales receipt in a safe place.

## Getting Started

The following steps will help you set up the ProFXv3 mixer quickly.

1. Turn down all knobs except the channel EQ and pan knobs, and set all the faders fully down.
2. Set all channel EQ knobs and pan knobs at their center detent.
3. Set all buttons to the “out” position.
4. Connect cords from the main outs to powered speakers (or to an amplifier connected to passive speakers).
5. Plug in the mixer’s power cord to a live AC outlet and turn on the mixer.
6. If you have powered speakers, turn them on. Otherwise, hook up your passive speakers to your amp with speaker cables, and turn it on. Adjust your powered speaker or amplifier level controls to however the manufacturer recommends.
7. Plug signal sources into the mixer, such as:
  - Microphones plugged into the mic inputs. Engage phantom power if your mics need it.
  - Line-level sources such as keyboards, drum machines, or CD players plugged into the line-level inputs.
8. Be sure that the volume of the input is the same as it would be during normal use.
9. Turn the channel’s gain knob clockwise until the level set LED begins to illuminate.
10. Engage the channel’s L-R assign switch (ProFX12v3 / ProFX16v3 / ProFX22v3 / ProFX30v3) and turn up that channel’s fader to the “U” (unity gain) position.
11. Slowly bring up the main fader to a comfortable listening level.
12. Repeat steps 7 to 10 for the other channels.

**Please write the serial numbers here for future reference (i.e., insurance claims, tech support, return authorization, make dad proud, etc.)**

**Purchased at:**

**Date of purchase:**

## Hookup Diagrams

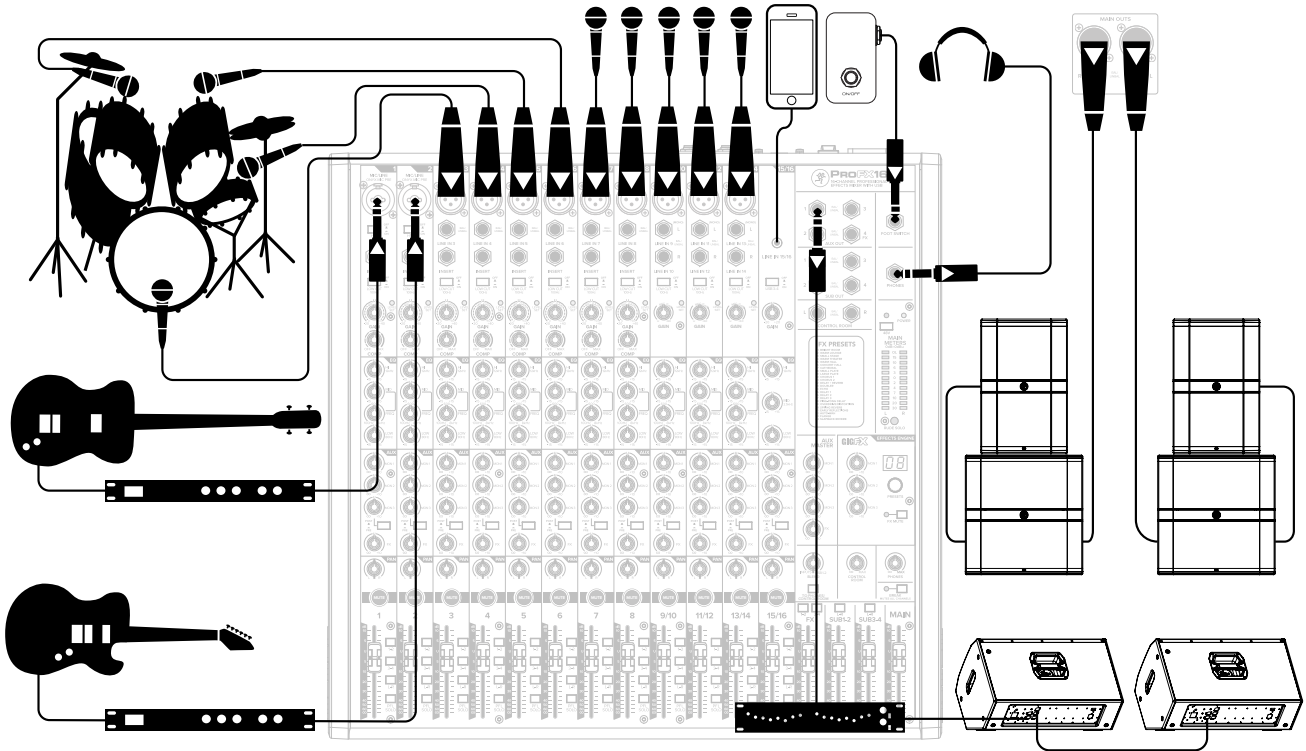

This diagram shows a bass and guitar attached to the channel 1 and 2 line-level inputs, each via a mono effects processor. The Hi-Z switch is engaged on both channels. A mic'd up drum kit utilizes the next four channels of the mixer. Microphones are connected to the following five channels and will handle lead and background vocal duties. A phone is connected to the last channel on the board, the 1/8" stereo input.

DRM18S powered subwoofers are connected to the left and right main outputs. Those are then connected to a pair of DRM215 loudspeakers to complete the PA. Two DRM212 loudspeakers are also set up as stage monitors and connect to the mixer's aux (monitor) output via a graphic EQ. The aux mon controls of each channel allow you to create a stage monitor mix as desired. Headphones are used for monitoring and a footswitch allows you to mute/unmute the internal effects as desired.

It's not shown, but a laptop may connect to the USB port on the rear panel of the mixer. It allows the main mix of the performance to be recorded to a DAW, as well as playback from the computer to the main mix.

Typical Live Sound System

## Hookup Diagrams Continued...

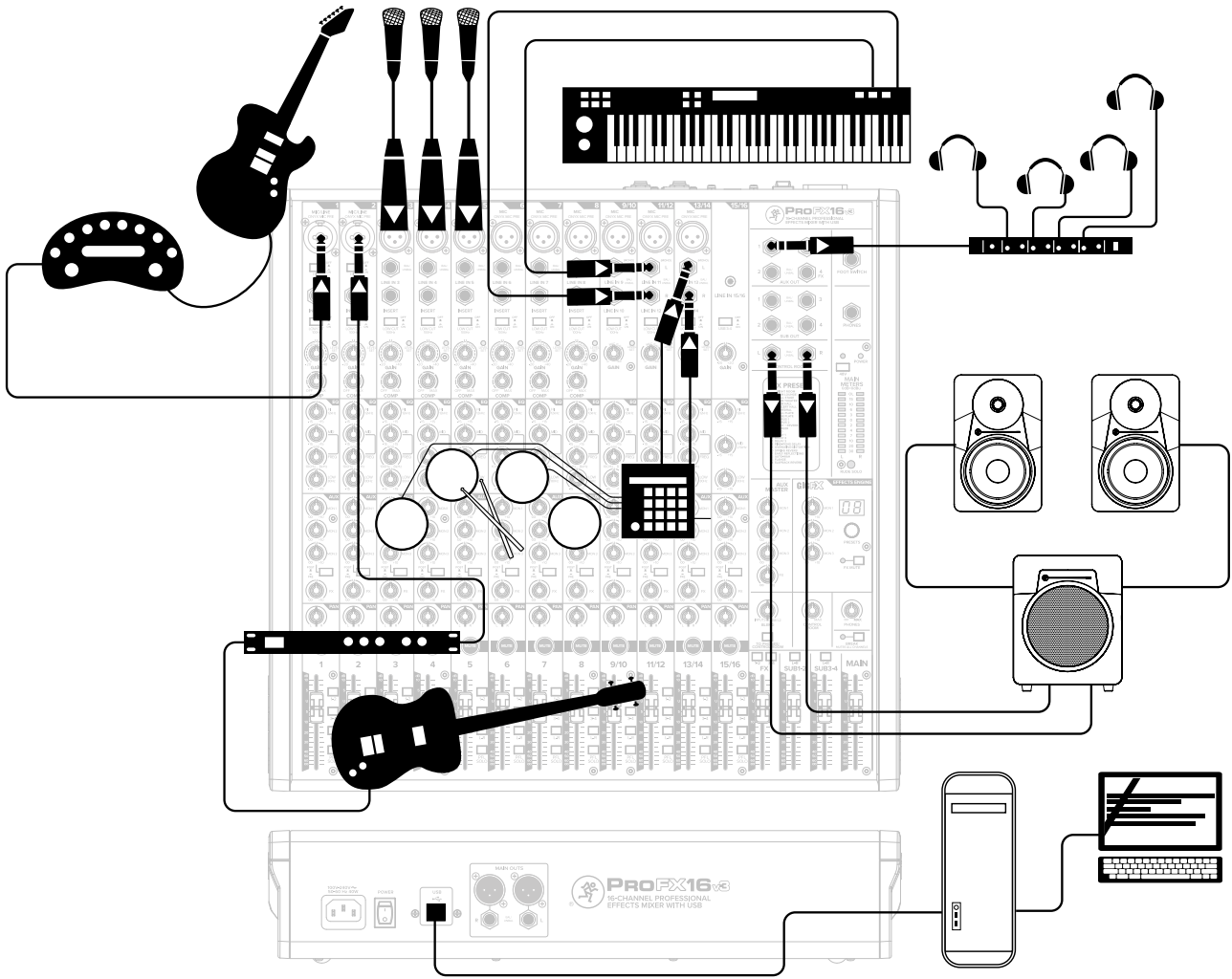

Like the previous hookup diagram, this one also starts with a bass and guitar attached to the channel 1 and 2 line-level inputs, each via a mono effects processor. The Hi-Z switch is engaged on both channels. Microphones are attached to channels 3, 4 and 5, a keyboard to stereo channels 11/12 and an electronic drum kit to stereo channels 13/14.

MR Series powered reference subwoofers and monitors are connected to the left and right control room outputs for careful and accurate monitoring of the performance. Headphones connected to aux out 1 via a headphone amp are available for the talent to utilize when tracking.

A desktop computer connects to the USB port to record the main mix to the DAW, as well as play back from the DAW.

### Typical Recording System

# ProFXv3 Rear Panel Features

ProFX6v3 • ProFX10v3

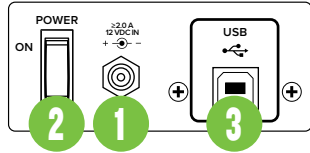

ProFX12v3

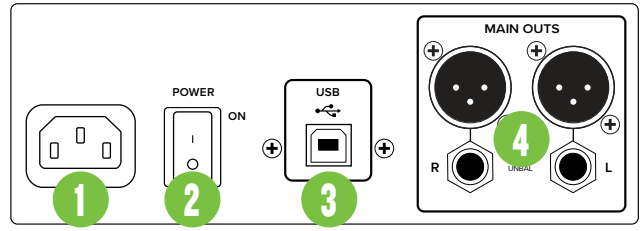
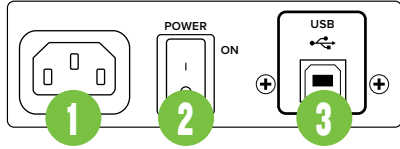

ProFX16v3 • ProFX22v3 • ProFX30v3

## 1. Power Connection

### ProFX6v3, ProFX10v3:

A locking barrel connector resides at one end of the line cord. Attach it to the power connector on the mixer and rotate the ring clockwise to lock. Do not over-tighten! Screw until there is resistance, then stop. Connect the other end into a live grounded AC outlet.

### ProFX12v3, ProFX16v3, ProFX22v3, ProFX30v3:

This is a standard 3-prong IEC power connector. Connect the detachable line cord (included in the box with your mixer) to the power receptacle, and plug the other end of the line cord into an AC outlet.

ProFXv3 Series mixers have a universal power supply that accepts any AC voltage ranging from 100 VAC to 240 VAC. No need for voltage select switches. It will work virtually anywhere in the world. That's why we call it a "Planet-Earth" power supply! It is less susceptible to voltage sags or spikes, compared to conventional power supplies, and provides greater electromagnetic isolation and better protection against AC line noise.



Disconnecting the plug's ground pin is dangerous. Don't do it.

## 2. Power Switch

Press the top of this rocker switch inwards to turn on the mixer. The front panel power LED will glow with happiness...or at least it will if you have the mixer plugged into a suitable live AC mains supply.

Press the bottom of this switch to turn the mixer off. It will not work at this point, but makes a handy paperweight.



As a general guide, you should turn on the mixer first, before any external power amplifiers or powered speakers, and turn it off last. This will reduce the possibility of any turn-on, or turn-off thumps in your speakers.

## 3. USB Input / Output

The built-in USB interface allows for some powerful and flexible routing. It is a 2x4, 24-bit / 192 kHz high-resolution interface allowing you to record a stereo signal to the computer via USB, and/or return two independent audio streams of stereo playback from a computer.

The USB routing capabilities are as follows:

### USB input TO the mixer – playback:

(1) A USB 3-4 switch is located on the last stereo channel – the one with the 1/8" input – of each mixer, so one may route computer output (such as Spotify®, Apple Music®, Pandora®, YouTube®, etc.) down the last stereo channel of the board. This stereo signal may then be EQ'd, sent to auxiliaries (i.e. to feed monitors, headphones or effects) and is routable to mains and/or subgroups via the fader routing features that are available on all other channels. In short, this signal may be sent to nearly any desired output or pair of outputs. Additionally, the associated gain knob adjusts the USB input level to the mixer to achieve an optimal signal level.

(2) A USB 1-2 blend knob and To Phones / Control Room switch is located near the lower-right side of each mixer so one may route the computer's DAW output (such as Pro Tools®, Traktion®, Cubase®, Reaper®, etc.) to the mixer and blend that signal with the live inputs of the mixer in the headphones for latency-free monitoring.

### USB output FROM the mixer – recording, etc:

It is possible to record the main mix to take home a copy of the live show. These levels are pre-main fader. Therefore, levels may be mixed up or down in the DAW later depending on the needs of the recording versus the live show. The end result is that fade-ins and/or fade-outs made during the show do not affect recorded levels.

## 4. Main Outputs

The main outputs provide a line-level signal that represents the end of the mixer chain, where the fully mixed stereo signal enters the real world. Connect these to the left and right inputs of your main power amplifiers, powered speakers, or serial effects processor (like a graphic equalizer or compressor/limiter).

The male XLR connectors provide a balanced line-level signal and is wired as follows, according to standards specified by the AES (Audio Engineering Society):

### XLR Balanced Wiring:

- Pin 1 = Shield (ground)
- Pin 2 = Positive (+ or hot)
- Pin 3 = Negative (- or cold)

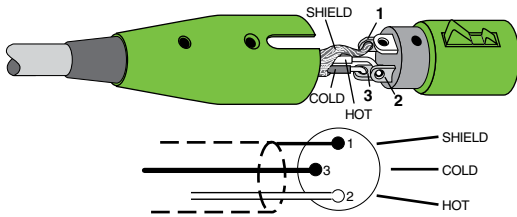

In addition to accepting balanced XLR connectors, the main outputs may also accept 1/4" connectors driven by balanced or unbalanced sources.

To connect balanced lines to these outputs, use a 1/4" Tip-Ring-Sleeve (TRS) plug. "TRS" stands for Tip-Ring-Sleeve, the three connection points available on a stereo 1/4" or balanced phone jack or plug. TRS jacks and plugs are used for balanced signals and are wired as follows:

### 1/4" TRS Balanced Mono Wiring:

- Sleeve = Shield
- Tip = Hot (+)
- Ring = Cold (-)

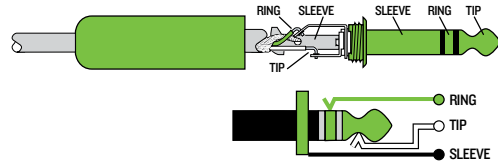

To connect unbalanced lines to these outputs, use a 1/4" mono (TS) phone plug, wired as follows:

### 1/4" TS Unbalanced Mono Wiring:

- Sleeve = Shield
- Tip = Hot (+)

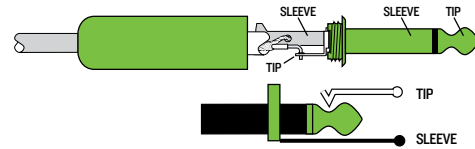

**NOTE** The main outputs are located on the front panel of the ProFX6v3, ProFX10v3 and ProFX12v3 and on the rear panel of the ProFX16v3, ProFX22v3 and ProFX30v3.

**NOTE** The XLR outputs are 6 dB hotter than the TRS outputs. When the meters read "0", the TRS outputs are at 0 dBu.



# ProFXv3 Front Panel Features Connections and Channel Strip

## Phantom Power

Most modern professional condenser mics require 48V phantom power, which lets the mixer send low-current DC voltage to the mic's electronics through the same wires that carry audio. (Semi-pro condenser mics often have batteries to accomplish the same thing.) "Phantom" owes its name to an ability to be "unseen" by dynamic mics (Shure SM57/SM58, for instance), which don't need external power and aren't affected by it anyway.

**NOTE** The ProFXv3 mixer's phantom power is globally controlled by the phantom power switch (meaning that phantom power for all mic inputs is turned on and off together.)

**BEWARE!** Never plug single-ended (unbalanced) microphones or ribbon microphones into the mic input jacks if phantom power is on. Do not plug instrument outputs into the mic input jacks with phantom power on unless you know for certain it is safe to do so.

The vertical channel strips look very similar between each model and have only a few differences between them. Each channel works independently, and just controls the signals plugged into the inputs directly above them.

## 5. XLR and 1/4" Combo Inputs [Chs. 1 and 2]

Input channels 1 and 2 on all ProFXv3 models may accept a balanced mic or line-level signal using an XLR connector. They are wired as follows, according to standards specified by the AES (Audio Engineering Society).

### XLR Balanced Wiring:

- Pin 1 = Shield (ground)
- Pin 2 = Positive (+ or hot)
- Pin 3 = Negative (- or cold)

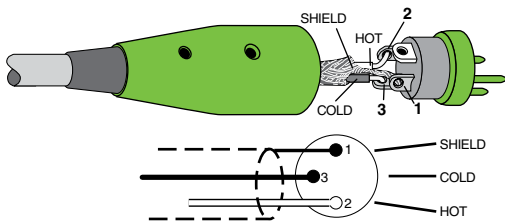

Both channels may also accept 1/4" line-level signals driven by balanced or unbalanced sources. Additionally, both channels may accept Hi-Z sources (such as guitars) via the 1/4" input without the need for a separate DI box. Don't forget to engage the Hi-Z switch, though!

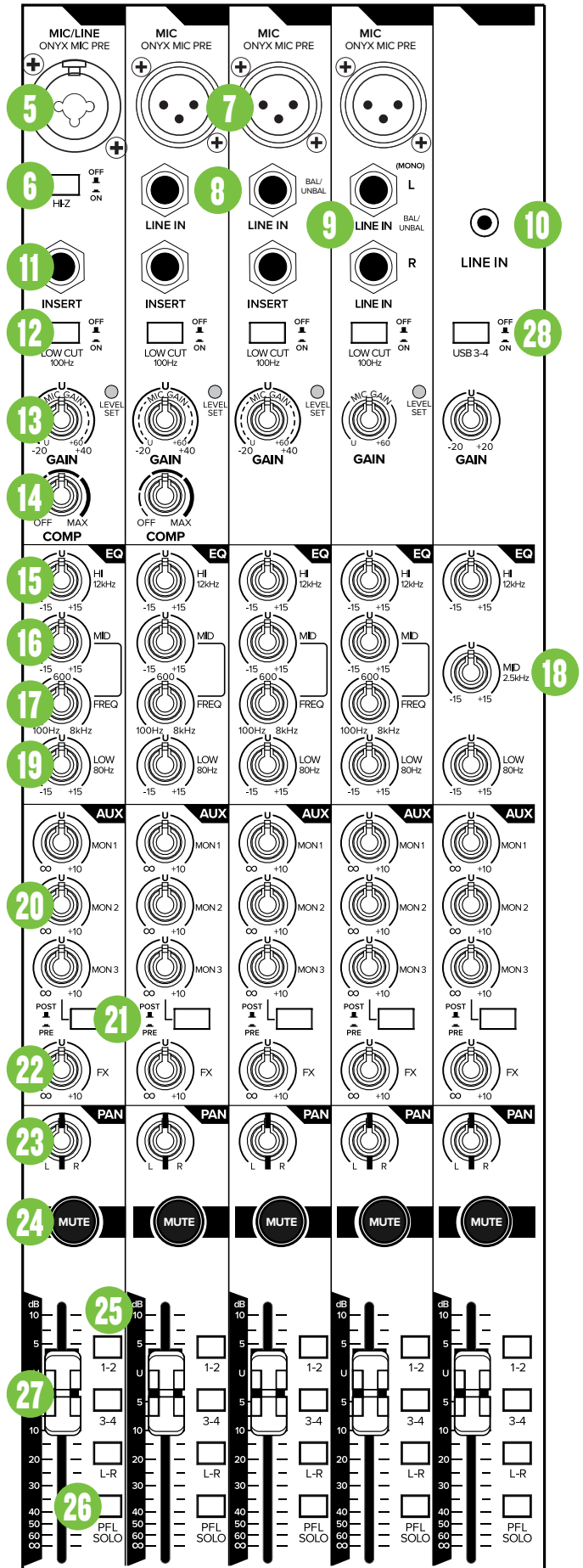

To connect balanced lines to these inputs, use a 1/4" Tip-Ring-Sleeve (TRS) plug. To connect unbalanced lines to these inputs, use a 1/4" mono (TS) phone plug. Wiring diagrams for both connectors are presented on page 8.



**NEVER** connect the output of an amplifier directly to a ProFXv3's input jack. This could damage the input circuitry and we wouldn't want that now, would we?

### 6. Line / Hi-Z Switch [Chs. 1 and 2]

To connect a guitar directly to the mixer without using a DI Box, press this switch in first; then connect the output from the guitar to the channel's 1/4" TRS input. The input impedance is optimized for direct connection and high-frequency fidelity is assured.

In the out position, the channel's 1/4" TRS input becomes a line input just like the other mono line inputs.

To use guitars or other instruments on other channels, you will need to use an external DI box first. Without the DI box – or if this switch is not pressed in – guitars may sound dull and muddy.

### 7. Mic Ins

This is a female XLR connector that accepts a balanced mic or line level input from almost any type of source. These Onyx mic preamps feature higher fidelity and headroom rivaling any standalone mic preamp on the market today. These circuits are excellent at rejecting hum and noise.

Professional ribbon, dynamic, and condenser mics all sound excellent through these inputs. The mic / line inputs will handle any kind of level you can toss at them, without overloading.

Wiring diagrams for these XLR connectors are presented on the previous page.



**NEVER** connect the output of an amplifier directly to a ProFXv3's input jack. This could damage the input circuitry and we wouldn't want that now, would we?

### 8. Line Ins

These 1/4" jacks share circuitry (but not phantom power) with the mic preamps, and can be driven by balanced or unbalanced sources at almost any level. You can use these inputs for virtually any signal you'll come across.

To connect balanced lines to these inputs, use a 1/4" Tip-Ring-Sleeve (TRS) plug. To connect unbalanced lines to these inputs, use a 1/4" mono (TS) phone plug. Wiring diagrams for both connectors are presented on page 8.



**NEVER** connect the output of an amplifier directly to a ProFXv3's input jack. This could damage the input circuitry and we wouldn't want that now, would we?

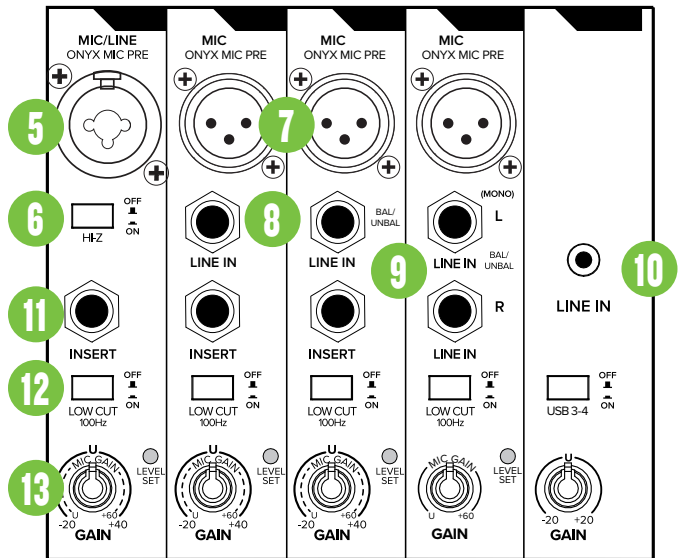

### 9. Stereo Line Inputs

The stereo line inputs are designed for 1/4" TRS balanced or 1/4" TS unbalanced signals. They may accept any line-level instrument, effects device, CD player, etc.

If you are connecting a mono source, use the left (mono) input, and the mono signals will appear on both sides of the main mix.

To connect balanced lines to these inputs, use a 1/4" Tip-Ring-Sleeve (TRS) plug. To connect unbalanced lines to these inputs, use a 1/4" mono (TS) phone plug. Wiring diagrams for both connectors are presented on page 8.



**NEVER** connect the output of an amplifier directly to a ProFXv3's input jack. This could damage the input circuitry and we wouldn't want that now, would we?

### 10. 1/8" Stereo Input

This stereo input may accept an 1/8" line-level signal from a phone, MP3 player, or other signal source.



**Last one! NEVER** connect the output of an amplifier directly to a ProFXv3's input jack. This could damage the input circuitry and we wouldn't want that now, would we?

## 11. Insert Jacks

These unbalanced 1/4" jacks are for connecting serial effects processors such as compressors, equalizers, de-essers, or filters.

The insert point is after the gain control and low cut filter, but before the channel's EQ and level. The channel signal can go out of the insert jack to an external device, be processed and come back in on the same insert jack.

To do this requires a standard insert cable that must be wired thusly:

- Tip = send (output to effects device)
- Ring = return (input from effects device)
- Sleeve = common ground

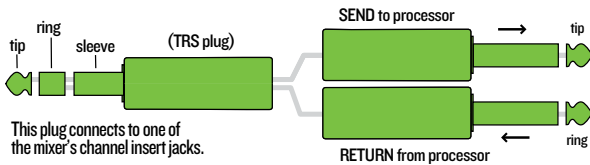

Insert jacks may be used as channel direct outputs; post-gain, and pre-EQ. If you insert a TS (mono) 1/4" plug only partially (to the first click) into an insert jack, the plug will not activate the jack switch and will not open the insert loop in the circuit (thereby allowing the channel signal to continue on its merry way through the mixer).

This allows you to tap out the channel signal without interrupting normal operation.

If you push the 1/4" TS plug in to the second click, you will open the jack switch and create a direct out, which does interrupt the signal in that channel. See illustration below.



Do not overload or short-circuit the signal you are tapping from the mixer. That will affect the internal signal.

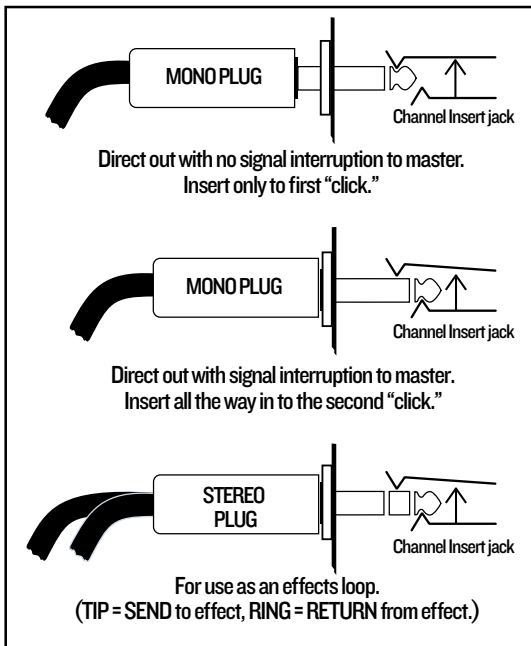

## 12. Low Cut Switches

All channels with a mic input have a low-cut switch (often referred to as a high-pass filter) that cuts bass frequencies below 100 Hz at a rate of 18 dB per octave.

We recommend that you use low-cut on every microphone application except kick drum, bass guitar, or bassy synth patches. These aside, there isn't much down there that you want to hear, and filtering it out makes the low stuff you do want much more crisp and tasty. Not only that, but low-cut can help reduce the possibility of feedback in live situations, and it helps to conserve amplifier power.



Another way to consider low-cut's function is that it actually adds flexibility during live performances. With the addition of low-cut, you can safely use low equalization on vocals.

Many times, bass shelving EQ can really benefit voices. Trouble is, adding low EQ also boosts stage rumble, mic handling clunks and breath pops from way-down low. Applying low-cut removes all those problems, so you can add low EQ without blowing the woofers.

### "U" like Unity gain

ProFXv3 Series mixers have a "U" symbol on almost every level control. It stands for "unity gain," meaning no change in signal level. The labels on the controls are measured in decibels (dB), so you'll know what you're doing level-wise if you choose to change a control's settings.

## 13. Gain Knobs and Level Set LEDs

If you haven't already, please read the "Getting Started" section on page 4. Setting the gain correctly will ensure that the preamplifier's gain is not too high, where distortion could occur, and not too low, where the quieter, exquisitely-delicate passages might be lost in background noise.

The gain knobs – in conjunction with the level set LEDs – adjust the input sensitivity of the mic and line inputs. This allows signals from the outside world to be adjusted to run through each channel at optimal internal operating levels.

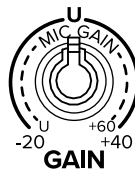

For mono channels (mic input with a mono line input), the gain knob adjusts the input sensitivity of the mic and line inputs.

If the signal originates through the mic XLR jack, there will be 0 dB of gain with the knob fully down, ramping to 60 dB of gain fully up.

Through the 1/4" mono line inputs, there is -20 dB of attenuation fully down and 40 dB of gain fully up, with unity gain "U" at 12:00.

This 20 dB of attenuation can be very handy when you are inserting a hot signal, or when you want to add EQ gain, or both. Without this "virtual pad," there is more chance of channel clipping.



**GAIN**

For hybrid channels (mic input and stereo line input), the gain control just affects the microphone input.

**Hybrid Channels:**

- ProFX6v3 – Channels 3/4 (no gain knob)
- ProFX10v3 – Channels 5/6 – 7/8 (no gain knobs)
- ProFX12v3 – Channels 5/6 – 9/10
- ProFX16v3 – Channels 9/10 – 13/14
- ProFX22v3 – Channels 15/16 – 19/20
- ProFX30v3 – Channels 23/24 – 27/28



**GAIN**

The gain control on the 1/8" stereo input channel has 20 dB of gain and 20 dB of attenuation.

**1/8" Stereo Channels:**

- ProFX6v3 – Channels 5/6 (no gain knob)
- ProFX10v3 – Channels 9/10 (no gain knobs)
- ProFX12v3 – Channels 11/12
- ProFX16v3 – Channels 15/16
- ProFX22v3 – Channels 21/22
- ProFX30v3 – Channels 29/30

Next to every gain knob – except the 1/8" stereo input gain knob – lies a level set LED. These LEDs are used with the gain control to set the channel preamplifier gain just right for each source. If one or more channels are distorting, check the level set LEDs. If they are on continuously, turn down the gain.

**14. Compressor Knobs**

The following channels of each ProFXv3 mixer has an in-line compressor circuit with a variable threshold.

- ProFX6v3 – No compressor knobs
- ProFX10v3 – Channels 1 – 2
- ProFX12v3 – Channels 1 – 4
- ProFX16v3 – Channels 1 – 8
- ProFX22v3 – Channels 1 – 12
- ProFX30v3 – Channels 1 – 16

This is very useful for compression of vocals, and snare drums, for example, so you might consider connecting your vocal and drum mics to these channels, rather than one of the other channels.

When the incoming signal exceeds the threshold level set by this knob, the signal level is automatically compressed. This reduces the dynamic range and reduces the chance of distortion due to overloading the input signals.



Dynamic range is the difference in level between the quietest and loudest parts of a song. A compressor “squeezes” the dynamic range, resulting in an overall steadier, more constant volume level for the signal. It helps sources, such as vocals, “sit” properly in the mix; it is very useful for live sound.

The compression ratio is fixed at around 6:1, with a soft knee response. The threshold can be adjusted clockwise from off (no compression) to 0 dBu (max).

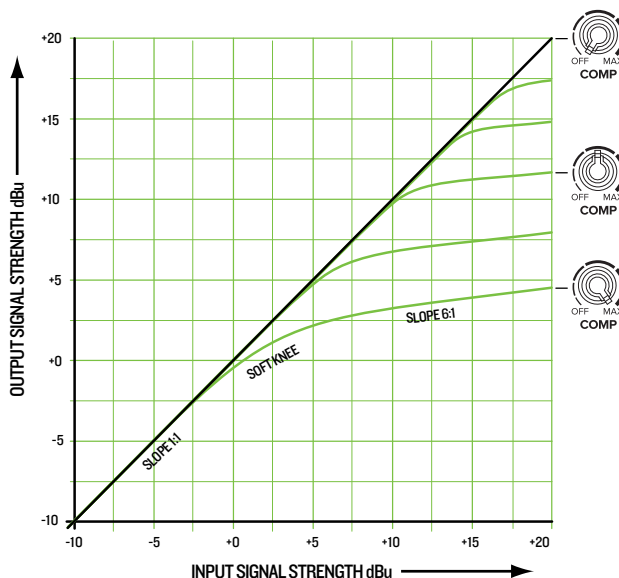

As an example, suppose the threshold is set to maximum. An incoming signal reaches the threshold of 0 dBu. As it increases beyond the threshold, it becomes compressed at a ratio of 6:1. This means that even if the input further increases by 6 dB, the actual output only increases by 1 dB. This compresses the output signal, so there is more protection to your system from distortion and overload due to poor microphone technique (say it ain't so) and general pops, bangs and heavy metal screaming. The soft knee means that the compression slowly ramps up to 6:1 from the threshold. It does not jump abruptly to 6:1, as this would be hard knee compression, and harder on the ears too.

The graph above shows the input signal level going into the compressor, versus the output level coming out of it. It is the typical graph to view when compressors are discussed, and is just the kind of thing our engineers like to discuss during the company Christmas party<sup>1</sup>.

If the compressor is off, then the input = output. For example, an input signal level of +5 dBu results in an output level of +5 dBu. The diagonal line from lower left to upper right represents  $x = y$ , that is, input = output.

At the maximum compression, the threshold is set at 0 dBu, and the input to output relationship is represented by the lower curve. If the input is -5 dBu (that is, below the threshold), the output is -5 dBu. As the input reaches 0 dBu, the output is a bit less than 0 dBu. If the input is +5 dBu, the output is about +2 dBu. If the input reaches +10 dBu, then the output is +3 dBu. Notice the shapely curve of the soft knee between the diagonal slope of  $x = y$  and the compressor slope of 6:1 (the compression ratio).

<sup>1</sup> My High School math teacher, Mr. Marvin, thought that graphs might come in handy for me one day. Finally!

The other green curves represent in-between positions of the compressor knob, with higher thresholds before compression begins.

Outboard compressors often have controls such as compression ratio, threshold, soft knee/hard knee, attack time, and release time. These last two affect how quickly the compressor kicks in when the input exceeds the threshold, and how quickly it is released after it drops below the threshold. In this compressor, these parameters are specially chosen to give you the best overall performance.

Adjust the threshold carefully, so your dynamic range is still lovely, without distortion or overload during the performance. Run through a few practice screams and high-notes, and adjust the compression as required.

### Channel Equalization (EQ)

All ProFXv3 mixers – except for the ProFX6v3 – have 3-band EQ with shelving hi, peaking mid with adjustable mid frequency [ProFX16v3, ProFX22v3, ProFX30v3] and shelving low.



The ProFX6v3 has 2-band EQ: shelving hi and shelving low.

Shelving means that the circuitry boosts or cuts all frequencies past the specified frequency. For example, the low EQ boosts bass frequencies below 80 Hz and continuing down to the lowest note you never heard. Peaking means that certain frequencies form a “hill” around the center frequency.



With too much EQ, you can really upset things. We've designed a lot of boost and cut into each equalizer circuit because we know that everyone will occasionally need that. But if you max the EQ on every channel, you'll get mix mush. Equalize subtly and use the left sides of the knobs (cut), as well as the right (boost). If you find yourself repeatedly using a lot of boost or cut, consider altering the sound source, such as placing a mic differently, trying a different kind of mic, a different vocalist, changing the strings, or gargling.

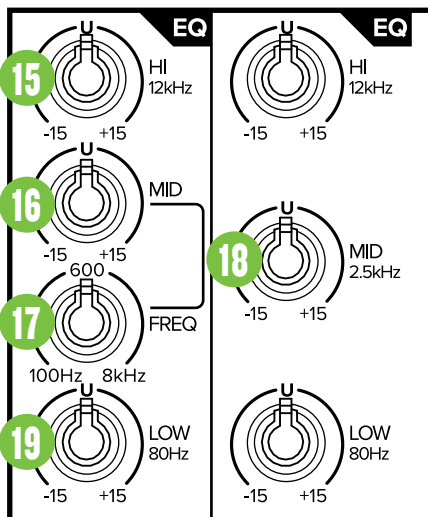

### 15. Hi EQ Knobs

The hi EQ provides up to 15 dB of boost or cut above 12 kHz, and it is also flat (no boost or cut) at the detent. Use it to add sizzle to cymbals, an overall sense of transparency, or an edge to keyboards, vocals, guitar and bacon frying. Turn it down a little to reduce sibilance or to mask tape hiss.

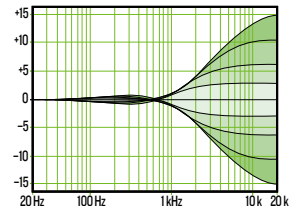

### 16. Mid EQ Knobs

#### 17. Freq Knobs

[ProFX16v3, ProFX22v3, ProFX30v3]

The ProFX16v3, ProFX22v3 and ProFX30v3 mixers employ a semi-parametric mid-sweep EQ. The gain (up to 15 dB of boost or cut) is set via the mid EQ, and then “aimed” at a specific frequency, from 100 Hz to 8 kHz, via the freq control.

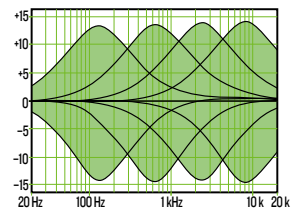

### 18. Mid EQ Knobs

Short for “midrange,” this knob provides up to 15 dB of boost or cut, centered at 2.5 kHz, also flat at the center detent. Midrange EQ is often thought of as the most dynamic, because the frequencies that define any particular sound are almost always found in this range. You can create many interesting and useful EQ changes by turning this knob down as well as up.

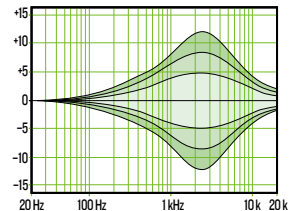

### 19. Low EQ Knobs

The low EQ provides up to 15 dB of boost or cut below 80 Hz. The circuit is flat at the center detent position. This frequency represents the punch in bass drums, bass guitar, fat synth patches, and some really serious male singers who eat raw beef for breakfast.

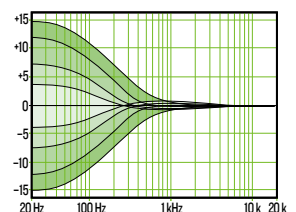

## 20. Aux Mon Knobs

These knobs tap a portion of each channel's signal to set up a nice monitor mix feeding stage monitors, independent of the main mix. Adjust these controls on each channel until the band is happy with the stage monitor mix.

The controls are off when fully turned down, deliver unity gain at the center detent, and can provide up to 10 dB of gain turned fully up.

The pan, mute and channel fader do not affect the monitor output, but the other channel controls will. The aux mon is pre-fader.

The overall output level may be adjusted with the aux master mon controls. Internal FX may also be added to the monitor mix with the GigFX master mon knobs.

## 21. Pre-Fader Switches

Aux sends 1-2 are always pre-fader, designed for stage monitor applications. Aux send 3 may be set to pre- or post-fader, so they may be used for monitors or effects.

**Pre-fader:** with the pre switch engaged (pressed in, not committed to marriage), aux 3 delivers signals post-insert, post-low cut, post-EQ, post-mute and pre-fader. Any changes made to the channel controls, except the fader, will affect the aux send signal.

**Post-fader:** with the pre switch disengaged (up), aux 3 delivers signals post-insert, post-low cut, post-mute, post-EQ and post-fader. Any changes made to the channel controls will affect the aux send signal.

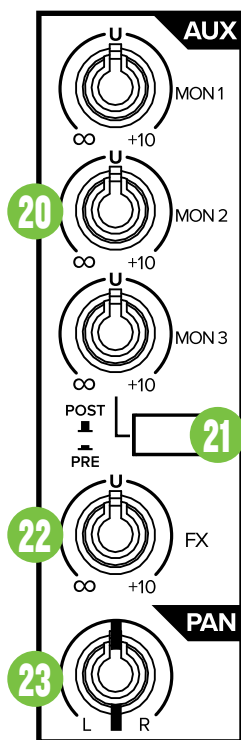

## 22. Aux FX Knobs

These knobs tap a portion of each channel's signal to set up a nice FX mix feeding the internal FX processor, and to feed external processors via the FX send.

The controls are off when fully turned down, deliver unity gain at the center detent, and can provide up to 10 dB of gain turned fully up.

The mute, channel fader and other channel controls affect the FX output, but pan does not. The aux FX is post-fader.

The FX signal reaching the internal FX processor and the FX send output jack is the sum (mix) of all the channels whose aux FX control is set to more than minimum.

The overall output level may be adjusted with the aux master FX knob. FX are then added to the main mix and subs 1-4 by raising the level of the FX fader.

## FX Switches (Chs. 1-2) [ProFX6v3]

With this switch out, no FX are added to the mix. With this switch in, the channel is assigned to the FX send post-channel level knob.

### ProFX6v3

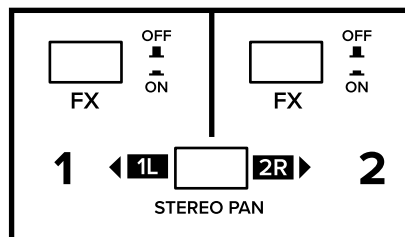

## Stereo Pan Switch (Chs. 1-2) [ProFX6v3]

With this switch out, each mono channel feeds both the left and right sides of the main mix equally. For example:

- **Playing a mono source:** If you talk into a microphone connected to input 1, your sweet tones will be heard in both the left and right loudspeakers.
- **Overdubbing a mono source:** if you are monitoring directly through the headphones, you can hear the overdub signal in both ears while you are playing.

With this switch pressed in, channel 1 will play only in the left side of the main mix, and channel 2 will play in the right side. For example:

- **Recording a stereo source:** If you have a stereo microphone connected to the mic inputs, or if you are playing a stereo source into the line inputs, each side of the source can be recorded discretely onto a recorder connected to the main outputs.

The pan switch does not affect the other channels.

## 23. Pan Knobs

This control allows you to adjust how much of the channel signal is sent to the left versus the right outputs.

The pan control employs a design called "Constant Loudness." If you have a channel panned hard left (or right) and then pan to the center, the signal is attenuated about 3 dB to maintain the same apparent loudness. Otherwise, it would make the sound appear much louder when panned center.

## 24. Mute Switches

Mute switches do just what they sound like they do. They turn off the signal by “routing” it into oblivion. Engaging a channel’s mute switch (almost) provides the same results as turning the fader all the way down (a pre-aux send is not affected by the channel fader, but it is by the mute switch).

Any channel assignments to the main mix, subgroup 1-2 or subgroup 3-4 will be interrupted and all of the aux sends will be silenced (both pre- and post-fader).

The channel insert will continue to provide a signal when a channel is muted. The mute button will illuminate when a channel’s mute switch is engaged.



Mute switches are available on all ProFXv3 mixers except the ProFX6v3.

## 25. Assign Switches

[ProFX12v3, ProFX16v3, ProFX22v3, ProFX30v3]

Alongside each channel fader are buttons referred to as channel assignment switches. Used in conjunction with the channel’s pan knob, they are used to determine the destination of the channel’s signal.

With the pan knob at the center detent, the left and right sides receive equal signal levels (main mix L/R, sub 1-2 and sub 3-4). To feed only one side or the other, turn the pan knob accordingly.

If you are doing a mixdown to a 2-track, for example, simply engage the main mix switch on each channel that you want to hear, and they will be sent to the main mix bus. If you want to create a group of certain channels, engage either the 1-2 or 3-4 switches instead of the main mix, and they will be sent to the appropriate subgroup faders. From there, the groups may be sent back to the main mix (using the group assign switches above the group faders), allowing you to use the group faders as a master control for those channels.

If you are creating new tracks or bouncing existing ones, you will also use the 1-2 and 3-4 switches, but not the main mix switch. Here you do not want the groups sent back into the main mix bus, but sent out, via the sub out jacks, to your multitrack inputs.

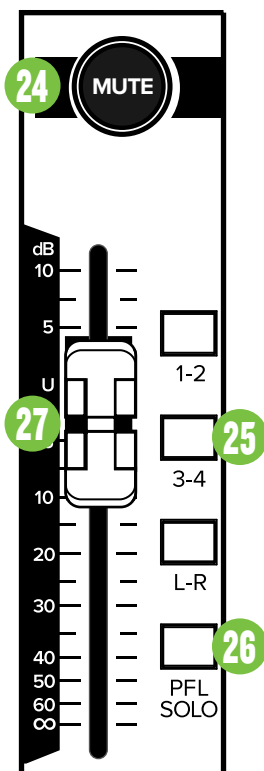

## 26. PFL Solo Switches

[ProFX12v3, ProFX16v3, ProFX22v3, ProFX30v3]

When a channel’s solo switch is engaged, any existing selection is replaced by the solo signal, appearing at the control room outputs, phones and at the left meter. The audible solo levels are then controlled by the CR and phones knobs. The solo levels appearing on the meters are not controlled by the CR and phones knob – you would not want that, anyway. What you do want to see is the actual channel level on the meters regardless of how loud the control room and phones output levels might be.

PFL means Pre-Fader Listen (post-EQ). With the PFL Solo switch engaged, solo will not be affected by a channel’s mute switch position.



Remember, PFL taps the channel signal before the fader. If you have a channel’s fader set way below “U” (unity gain), solo will not know that and will send a unity gain signal to the CR outs, phones output and meter display, which may raise some eyebrows.

## 27. Channel Faders

This is the last control in a channel’s signal path, and it adjusts the level of each channel onto the main mix. The “U” mark indicates unity gain, meaning no increase or decrease of signal level. All the way up provides an additional 10 dB, should you need to boost a section of a song. If you find that the overall level is too quiet or too loud with the level near unity, check that the gain control is set correctly.



The “Channel Faders” on the ProFX6v3 and ProFX10v3 are actually “Channel Knobs”. But they behave similarly.

## 28. USB Switch

When engaged, this switch overrides the 1/8” input and allows the USB return – stereo playback of iTunes® or a DAW via the USB connection, for example – to flow through the signal path instead. Like any other input, this signal may also be EQ’d, sent to an aux bus, or mixed in with the other signals and assigned to subgroups or main outs.

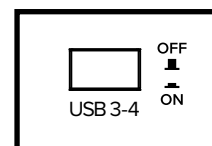

## Additional Inputs and Outputs

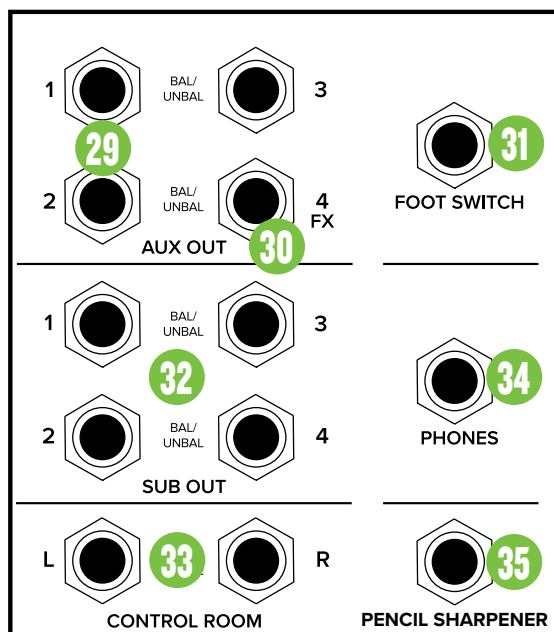

### 29. Aux Out / Mon Send [ProFX12v3, ProFX16v3, ProFX22v3, ProFX30v3]

Stage monitors allow the talented musicians in the band to hear themselves clearly on stage. This can be a good thing! The monitor mix may be carefully adjusted in level using the aux mon controls. These tap a portion of each channel's signal to provide a 1/4" TRS output here to feed external stage monitors. These could either be passive stage monitors powered by an external amplifier, or powered stage monitors with their own built-in amplifier.

The monitor signal is the sum (mix) of all the channels whose aux mon control is set to more than minimum. If they want "more me and less Brian," you may turn up their channel's aux mon control, and turn down Brian's.

The overall output level may be adjusted with the aux master mon knob. Additionally, you could add an external graphic EQ between this output and your powered monitors. This will allow you to adjust the EQ, and minimize the chance of feedback from nearby microphones.

The monitor output is not affected by the main mix fader or the channel faders. This allows you to set up the monitor mix and level just right, and not have it change when a channel fader or the main mix fader is adjusted. This is known as "pre-fader."



There is one mon send jack on the ProFX12v3 and three aux out jacks on the ProFX16v3, ProFX22v3 and ProFX30v3.

### 30. FX Send [ProFX10v3, ProFX12v3, ProFX16v3, ProFX22v3, ProFX30v3]

This 1/4" TRS line-level output may be used to feed an external effects processor (FX), such as a nice sound effect or delay unit. The output from this jack is an exact copy of what goes into the internal FX processor, being the careful mix of all channels whose aux FX control is turned to more than minimum.

(The processed output of the internal FX does not come out of this output, but is added internally to the main mix or monitor mix.)

The overall output level may be adjusted with the aux master FX knob. (This knob also affects the level going into the internal FX.)

The output is "post-fader," so any changes to the channel faders will also affect the level going to the external processor.

The processed output from the effects processor is usually returned to a spare channel, and you may carefully mix the original unprocessed channel (dry) and the processed channel (wet). Altering the original channel fader increases both the wet and dry signals and keeps them at the same delicate ratio. For example, the reverb remains at the same level relative to the original.

### 31. FX Footswitch [ProFX10v3, ProFX12v3, ProFX16v3, ProFX22v3, ProFX30v3]

This 1/4" TRS connector is where to connect your favorite footswitch. This allows you to easily mute or un-mute the internal effects at will. Any one-button on/off footswitch will work.

If the internal FX have already been muted with the internal FX mute switch, then the footswitch has no effect.

## Main Outputs

The main outputs are located on the front panel of the ProFX6v3, ProFX10v3 and ProFX12v3 and on the rear panel of the ProFX16v3, ProFX22v3 and ProFX30v3. Please check out page 8 for more information about the main outputs.



### 32. Sub Out Jacks [ProFX12v3, ProFX16v3, ProFX22v3, ProFX30v3]

These 1/4" jacks are usually patched to the inputs of a multitrack deck or to secondary amplifiers in a complex installation.



There are two sub out jacks on the ProFX12v3 and four sub out jacks on the ProFX16v3, ProFX22v3 and ProFX30v3.

### 33. Control Room Out Jacks [ProFX10v3, ProFX12v3, ProFX16v3, ProFX22v3, ProFX30v3]

These 1/4" jacks are usually patched to the inputs of a control room amplifier or a headphone distribution amplifier.

The control room outputs may also be used for other applications. The sound quality is just as impeccable as the main outputs. It may be used as an additional main mix output and this one will have its own level control. However, be aware that if a solo switch is engaged, the mix will be interrupted:



When a channel's solo switch is engaged, any existing selection is replaced by the solo signal, appearing at the control room outputs, phones and at the left meter. The audible solo levels are then controlled by the control room knob. The solo levels appearing on the meters are not controlled by the control room knob – you would not want that, anyway. What you do want to see is the actual channel level on the meters regardless of how loud the control room output level might be.



The signal leaving the CR outs may also accept a post-blend mix of the inputs and USB return if the "To Phones / Control Room" switch is engaged. More information about this switch (and the "Blend" knob) may be found on page 20. Because there are no control room outputs on the ProFX6v3, there is a "To Phones" only switch.

### 34. Phones Jack

This 1/4" TRS connector supplies the output to stereo headphones.

The phones volume is controlled with the phones knob located above the main mix fader (except for the ProFX6v3, in which case it's directly to the left of the main mix knob).

Whenever a solo switch is engaged, you will only hear the soloed channel(s) in the headphones. This gives you the opportunity to audition the channels before they are added to the main mix. (Solo signals reaching the headphones are not affected by the channel level or main level, therefore turn down the phones level first, as soloed channels may be loud.)

#### The phones output follows standard conventions:

Tip = Left channel  
Ring = Right channel  
Sleeve = Common ground



**WARNING:** The headphone amp is loud and can cause permanent hearing damage. Even intermediate levels may be painfully loud with some headphones. **BE CAREFUL!** Always turn the phones level control all the way down before connecting headphones or pressing a solo switch, or doing anything new that may affect the headphone volume. Then turn it up slowly as you listen carefully.



The signal leaving the phones jack may also accept a post-blend mix of the inputs and USB return if the "To Phones / Control Room" switch is engaged. More information about this switch (and the "Blend" knob) may be found on page 20.

### 35. Pencil Sharpener

Need to take notes during a recording or live performance, but the pencil needs to be sharpened? This works like any 'ol electric pencil sharpener. Place your pencil in here to sharpen it and start writing notes!

## 48V Phantom Power, Power LED, Main Meters and Rude Solo!

### 36. 48V Phantom Power Switch

Most modern professional condenser mics require 48V phantom power, which lets the mixer send low-current DC voltage to the mic's electronics through the same wires that carry audio. (Semi-pro condenser mics often have batteries to accomplish the same thing.) "Phantom" owes its name to an ability to be "unseen" by dynamic mics (Shure SM57/SM58, for instance), which don't need external power and aren't affected by it anyway.

Press this switch in if your microphone requires phantom power. (Always check the position of this switch before connecting microphones.) The accompanying LED will illuminate red to indicate that phantom power is active. This is a global switch that affects all mic channels' XLR jacks at once.



Never plug single-ended (unbalanced) microphones, or ribbon mics into the mic input jacks if phantom power is on. Do not plug instrument outputs into the mic XLR input jacks with phantom power on unless you know for certain it is safe to do so. Be sure the main mix fader is turned down when connecting microphones to the mic inputs when phantom power is turned on to prevent pops from getting through to the speakers.

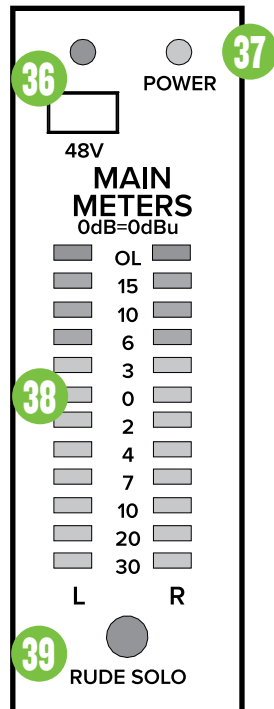

### 37. Power LED

This LED will illuminate green when the mixer is turned on, as a reminder of how on it really is. If it is not on, then it is off, and the mixer becomes a rather nice weight for keeping your morning newspaper from blowing away in the wind.

If it does not turn on, make sure the power cord is correctly inserted at both ends, the local AC mains supply is active, and the power switch is on.

### 38. Main Meters

These peak meters are made up of two columns of twelve LEDs, with three colors to indicate different ranges of signal level, traffic light style. They range from -30 at the bottom, to 0 in the middle, to OL at the top.

When a channel is soloed [ProFX12v3, ProFX16v3, ProFX22v3, ProFX30v3], the right meter shows no reading, and the left meter shows the level of that channel's signal level, pre-fader.

You can get a good mix with peaks flashing anywhere between -20 and +10 dB on the meters. Most amplifiers clip at about +10 dBu, and some recorders aren't so forgiving either. For best real-world results, try to keep your peaks between "0" and "+6." Remember, audio meters are just tools to help assure you that your levels are "in the ballpark." You don't have to stare at them (unless you want to).

**NOTE** The meters on the ProFX6v3 are slightly different. It has only eight LEDs and they range from -24 to OL. Here you can get a good mix with peaks flashing anywhere between -12 and +8 dB on the meters.

### 39. Rude Solo LED [ProFX12v3, ProFX16v3, ProFX22v3, ProFX30v3]

This large LED flashes red when one or more solo switches are engaged. This acts as a reminder that what you hear in the control room and headphones is the soloed channel(s). If you forget that you are in solo mode, you can easily be tricked into thinking that something is wrong with your mixer. Hence, the rude solo light. Please forgive its rudeness, it is only trying to help, and wants to be your friend.

**NOTE** Because there are no solo switches on the ProFX6v3 and ProFX10v3, there are no Rude Solo LEDs, either.

# Aux Masters and Internal FX

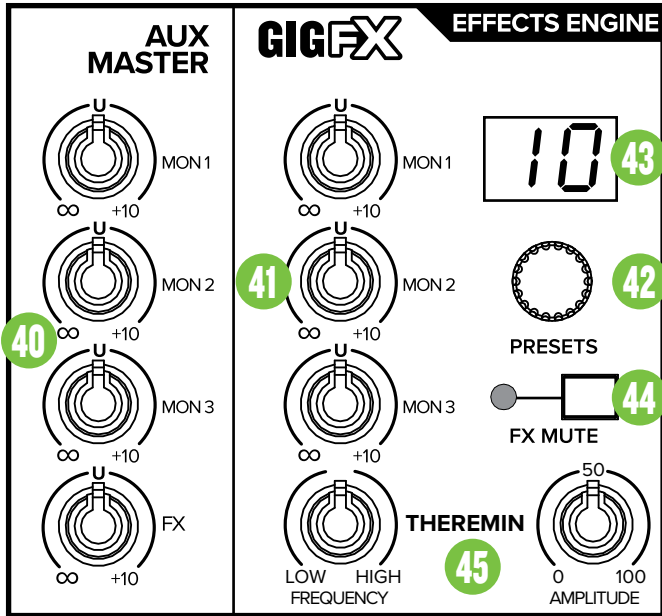

## 40. Aux Master Knobs [ProFX12v3, ProFX16v3, ProFX22v3, ProFX30v3]

These provide overall control over the aux mon and aux FX levels just before they are delivered to the aux mon and aux FX outputs, as well as internal FX in the case of the FX master.

Auxiliary is usually the control you turn up when the lead singer glares at you, points at his stage monitor, and sticks his thumb up in the air. (It would follow that if the singer stuck his thumb down, you'd turn the knob down, but that never happens.)

**NOTE** The ProFX12v3 has a single aux master and no aux FX master.

## 41. FX to Mon Knobs [ProFX12v3, ProFX16v3, ProFX22v3, ProFX30v3]

These knobs route the effects output to the monitors. Use the mon controls to provide effects to monitors. Slowly add effects to the monitors by turning the mon knobs clockwise. Use the aux master knobs (described above) to monitor the amount sent.

**NOTE** The ProFX12v3 has a single FX to mon knob.

## 42. Preset Selector

Rotate this endless control to select one of the 24 preset effects. When the rotation stops, that preset number will flash for 10 seconds. Push the control in prior to that in order to select the preset or let it revert back to the previously selected preset. The current preset number is shown in the display. The different presets are shown in the table below and on the mixer's silkscreen near the main meters. Further details of each preset are explained in Appendix C on page 40. Only one preset may be selected at a time.

1	Bright Room	13	Doubler
2	Warm Lounge	14	Echo
3	Small Stage	15	Delay 1 (Fast)
4	Warm Theater	16	Delay 2 (Medium)
5	Warm Hall	17	Delay 3 (Slow)
6	Concert Hall	18	Ping-Pong Delay
7	Cathedral	19	Overdrive / Distortion
8	Small Plate	20	Spring Reverb
9	Large Plate	21	Early Reflections
10	Chorus 1	22	Auto-Wah
11	Chorus 2	23	Flange
12	Delay + Reverb	24	Slapback Reverb

## 43. Preset Display

This display shows the number of the currently selected effects preset, as shown in the list of presets above. Rotate the preset selector knob right or left to change a preset. When the mixer is turned on, the FX section will load up the last-used preset.

## 44. FX Mute Switch and LED

When engaged, the internal effects processor is muted, and its output will not appear on the main mix or monitor mix. The adjacent mute LED will illuminate as a reminder that the effects are muted. When power is first applied to the mixer, this LED will illuminate and the FX will be muted for about 5 seconds while the little FX gerbils inside settle down.

If this switch is not engaged, then the internal effects are set free and may be added as required to the main mix and/or monitor mix.

If this switch is not engaged, then the internal effects may be muted or un-muted with a footswitch [all ProFXv3 mixers except the ProFX6v3].

### 45. Theremin

A theremin is more of an instrument than an effect. That said, it fits really well here in the FX section. Additionally, theremins can be expensive, take up a bit of space and can be unwieldy. But not here... just a simple two knob “theremin” built right into the mixer!

The two knobs are frequency and amplitude. Frequency is another word for “pitch”. The frequency is at its lowest when the knob is fully counter-clockwise and at its highest when fully clockwise. Amplitude is another word for “volume”. The amplitude is at its lowest when the knob is fully counter-clockwise and at its highest when fully clockwise.

**NOTE** Don't fret if your mixer doesn't come with built-in Theremin knobs. They do not exist... yet. No doubt that would be a cool feature, but perhaps on our next mixer series...

### 47. To Phones / Control Room Switch

By default, the control room and phones jacks output the 2-track LR mix (or soloed channels, if any are engaged). Push this switch in if you want to interrupt this signal and hear the blended signals instead.

**NOTE** Because there are no control room outputs on the ProFX6v3, there is a “To Phones” only switch.

### 48. Control Room Knob

This knob is used to adjust the volume at the control room outputs, from ∞ (off) to maximum gain (max). Make sure that this knob is fully off [counter-clockwise] before selecting or adding a new source.

**NOTE** Because there are no control room outputs on the ProFX6v3, there is no control room knob, either.

## Blend, Control Room and Phones

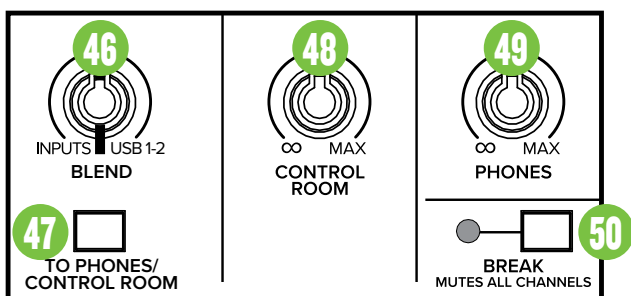

### 46. Blend Knob

The blend knob adjusts the level of all inputs (except the 1/8" input) and USB 1-2 Return to be delivered to the main outputs (and phones and control room if the adjacent switch is engaged, see below). As an added bonus, this is all at zero-latency!

Use this knob while recording overdubs alongside a pre-recorded track, for example.

Knob position (L, C, R):

- Full Left – Inputs = Full Volume  
USB Return = No Volume
- Center – Inputs and USB Return = Equal Volume
- Full Right – Inputs = No Volume  
USB Return = Full Volume

### 49. Phones Knob

This knob is used to adjust the volume at the phones output from ∞ (off) to maximum gain (max). Make sure that this knob is fully off [counter-clockwise] before selecting or adding a new source.

**VERY IMPORTANT!** **WARNING:** The headphone amp is loud, and can cause permanent hearing damage. Even intermediate levels may be painfully loud with some headphones. **BE CAREFUL!** Always turn this control all the way down before connecting headphones, or pressing a solo switch, or doing anything new that may affect the headphone volume. Then turn it up slowly as you listen carefully.

### 50. Break Switch and LED

This important “take-a-break” switch quickly mutes all the microphones and line-level inputs to the main outs, or outs and phones when the band is between sets. This will prevent protestors or rogue karaoke singers from storming the stage at the interval.

The monitor send and FX send are not affected. If there is no sound coming out of the system, be sure to check this switch first.

It is possible to play audio coming in from the computer via the USB inputs. For example, a soothing CD may be played while the band is off stage.

The adjacent break LED will illuminate as a reminder that the channels are muted.

# FX, Sub and Main Faders and Switches!

## 51. FX Knob / Fader

Stereo signals come through this FX fader – FX knob on the ProFX6v3 and ProFX10v3 – and continue on to the main mix fader. They contain the effects’ “wet” signals and are mixed together with the channels’ “dry” original signals. Turned fully up, it provides 10 dB of additional gain, the “U” mark is unity gain, and fully down is off.

## 52. FX to Subs Switches [ProFX12v3, ProFX16v3, ProFX22v3, ProFX30v3]

Fancy yourself adding FX to the sub groups in addition to the main mix? Simply engage the switch to route FX to subs 1-2 and/or subs 3-4.

**NOTE** Because the ProFX12v3 has a single sub group (1-2), it also has a single FX-to-sub (1-2) assign switch.

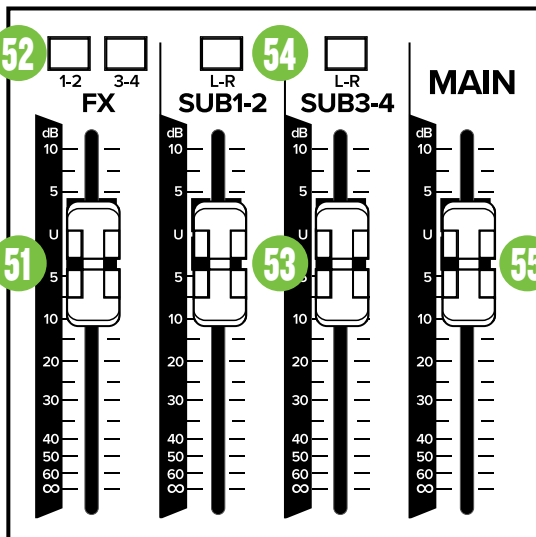

## 53. Sub 1-4 Faders [ProFX12v3, ProFX16v3, ProFX22v3, ProFX30v3]

As you might expect, these faders control the levels of the signals sent to the sub out jacks. All channels that are assigned to subs, not muted, and not turned fully down will appear at the sub outs.

The sub signal is off when its fader is fully down, the “U” marking is unity gain, and fully up provides 10 dB additional gain. Each sub fader works as a stereo pair; sub 1 and 2 on a single fader, for example, to easily maintain the left/right balance.

**NOTE** The ProFX12v3 has a single sub 1-2 fader, no sub 3-4 fader.

## 54. Subs Assign Switches [ProFX12v3, ProFX16v3, ProFX22v3, ProFX30v3]

One popular use of the subs is to use them as master faders for a group of channels on their way to the main mix fader. Let us say you have a drum kit hogging up seven channels and you are going to want to control their group volume more conveniently. You do not want to try that with seven hands or seven fingers, so just unassign these channels from the main mix and reassign them to sub 1-2 and engage the main mix L-R switch located above the fader. Now you may ride the entire drum mix with a single fader – sub 1-2.

**NOTE** Because the ProFX12v3 has a single sub 1-2 fader, it also has a single sub-to-L-R assign switch.

## 55. Main Mix Fader

This stereo fader allows you to adjust the levels of the main mix signals sent to the XLR and 1/4” main line-level outputs.

This gives you the ultimate feeling of power and control over the sound levels sent to your audience. Adjust this control carefully, with your good eye on the meters to check against overloading, and your good ear to the levels to make sure your audience (if any) is happy.

The main mix signals are off with the fader fully down, the “U” marking is unity gain, and fully up provides 10 dB of additional gain. This additional gain will typically never be needed, but once again, it’s nice to know that it’s there. The fader is stereo, as it affects both the left and right of the main mix equally. This is the ideal control to slowly bring down at the end of a song (or quickly in the middle of a song if the need ever arises).

This control does not affect the aux / mon send or FX send outputs.

**NOTE** The “Main Mix Fader” on the ProFX6v3 and ProFX10v3 is actually a “Main Mix Knob”. But they behave similarly.

## Appendix A: Service Information

If you think your mixer has a problem, please check out the following troubleshooting tips and do your best to confirm the problem. Visit the Support section of our website ([www.mackie.com](http://www.mackie.com)) where you will find lots of useful information such as FAQs, documentation and any updated PC drivers etc. You may find the answer to the problem without having to send your mixer away.

### Troubleshooting

#### No Power

- Our favorite question: Is it plugged in? Make sure the AC outlet is live [check with a tester or lamp].
- Our next favorite question: Is the power switch on? If not, try turning it on.
- Make sure the line cord is securely seated in the line cord socket and plugged all the way into the AC outlet.
- Is the power LED on the top panel illuminated? If not, make sure the AC outlet is live. If so, refer to “No sound” below.
- The internal AC line fuse may be blown. This is not a user serviceable part. If you suspect the AC line fuse is blown, please see the “Repair” section next.

#### Hum

- Try disconnecting the cable connected to the input jack. If the noise disappears, it could be a “ground loop,” rather than a problem with the mixer.

Try some of the following troubleshooting ideas:

- Use balanced connections throughout your system for the best noise rejection.
- Whenever possible, plug all the audio equipment’s line cords into outlets which share a common ground. The distance between the outlets and the common ground should be as short as possible.

#### Bad Channel

- Try the same source signal in another channel, set up exactly like the suspect channel.
- Is phantom power required for your microphone?

#### No sound

- Is the level knob for the input source turned all the way down? Verify that all the volume controls in the system are properly adjusted. Look at the level set LEDs and meters to ensure that the mixer is receiving a signal.
- Is the signal source working? Make sure the connecting cables are in good repair and securely connected at both ends. Make sure the master volume level is turned up sufficiently to drive the inputs of the speaker.
- Make sure the input source is not muted or has a processor loop engaged. If you find something like this, make sure the level is turned down before disengaging the offending switch.
- Is the main level turned up?
- Are the EQs set to reasonable levels?
- Are any aux returns maxed out?
- Unplug anything from the other line-level outputs, such as monitor out, just in case one of the external pieces has a problem.
- Make sure that you are not overdriving the amplifiers. Check the loudspeaker average load impedance is not less than the minimum the amplifier can handle. Check the speaker wiring.

#### Noise

- Turn the channel gains down, one by one. If the sound disappears, it’s either that channel or whatever is plugged into it, so unplug whatever that is. If the noise disappears, it’s from your whatever.
- Make sure none of the signal cables are routed near AC cables, power transformers, or other EMI-inducing devices.
- Is there a light dimmer or other SCR-based device on the same AC circuit as the mixer? Use an AC line filter or plug it into a different AC circuit.

## ASIO Blues?

- There is a lot of great information here, including ASIO driver downloads, FAQs, troubleshooting, a forum and more! Please review before calling Technical Support:
  - o <http://www.asio4all.org/>

## Other Issues

- Please email or call Technical Support if you are having any other issue not listed here:
  - o [mackie.com/support-contact](http://mackie.com/support-contact)
  - o 1-800-898-3211

## Repair

For warranty service, refer to the warranty information on page 41.

Non-warranty service is available at a factory-authorized service center. To locate the nearest service center, visit [www.mackie.com/support/service-locator](http://www.mackie.com/support/service-locator). Service for ProFXv3 Series mixers living outside the United States can be obtained through local dealers or distributors.

If you do not have access to our website, you can call our Tech Support department at 1-800-898-3211, Monday-Friday during normal business hours, Pacific Time, to explain the problem. Tech Support will tell you where the nearest factory-authorized service center is located in your area.

## Microphone Stand

The bottom panels of the ProFX6v3 and ProFX10v3 have three non-threaded holes that allow it to be fitted with an optional microphone stand adapter. This lets you support the mixer on a standard mic stand, and adjust its height and level to whatever suits your strangely-complex set of preferences.

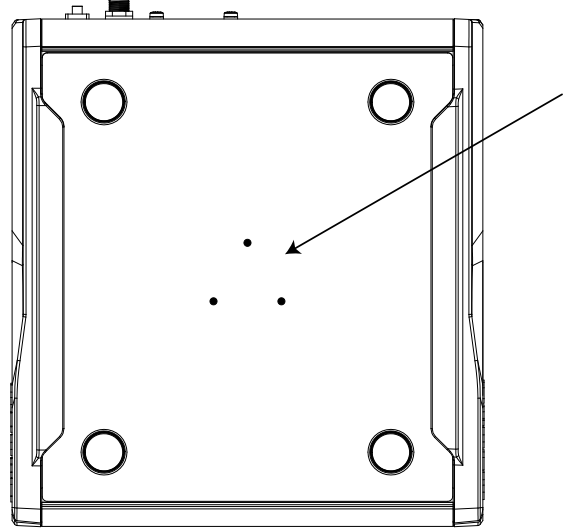

1. Order the Atlas AD-11B mic stand adapter available from many a fine music store. (It is made and distributed by Atlas Sound.)
2. Use three Trilobular thread rolling screws 6-32 x 1/4" long to secure the adapter to the bottom of the mixer [see below].



Do not use screws longer than 1/4" as these could damage the circuit boards. Do not use screws shorter than 1/4" or the adapter will not be securely fixed to the mixer.

## Appendix B: Technical Information

### ProFXv3 Specifications

#### Noise Characteristics

Equivalent Input Noise (EIN) (150 Ω Source Impedance, 20 Hz to 20 kHz)	
Mic in to Insert Send out, max gain	-126 dBu <sup>1</sup> -128 dBu <sup>2</sup>
Residual Output Noise	
All outputs, master levels off, all channel levels off	-95 dBu
All outputs, master levels unity, one channel level unity	-80 dBu <sup>1</sup> -85 dBu <sup>2</sup>

#### Frequency Response

Mic input to any output (gain at unity, +0 dB / -1 dB)	20 Hz to 30 kHz
--	-----------------

#### Distortion (THD+N)

(22 Hz to 80 kHz bandwidth)	
Mic in to Main Out (+4 dBu output)	<0.03% <sup>1</sup> <0.01% <sup>2</sup>

#### Attenuation and Crosstalk

Adjacent Inputs @1 kHz	-90 dB
Inputs to Outputs @1 kHz	-80 dB
Fader Off @1 kHz	-75 dB
Mute Switch / Break Switch Mute @ 1 kHz	-90 dB <sup>1</sup> -100 dB <sup>2</sup>

#### Common Mode Rejection Ratio (CMRR)

Mic in to Main out, max gain, 1 kHz	70 dB
-------------------------------------	-------

#### Maximum Levels

All inputs	+22 dBu
Main Mix XLR	+28 dBu
All other outputs	+22 dBu

#### Impedances

Mic in	3.3 kΩ
Channel Insert Return	10 kΩ
All other inputs	≥20 kΩ
Phones out	25 Ω
All other outputs	120 Ω Unbalanced, 240 Ω Balanced

#### Equalization

ProFX6v3	
Low	±15 dB @ 80 Hz
High	±15 dB @ 12 kHz
Low Cut Filter	18 dB/octave @ 100 Hz
ProFX10v3 • ProFX12v3	
Low	±15 dB @ 80 Hz
Mid	±15 dB @ 2.5 kHz
High	±15 dB @ 12 kHz
Low Cut Filter	18 dB/octave @ 100 Hz
ProFX16v3 • ProFX22v3 • ProFX30v3	
All Channels (except 1/8" stereo channel)	
Low	±15 dB @ 80 Hz
Mid	±15 dB
	100 Hz – 8 kHz
High	±15 dB @ 12 kHz
Low Cut Filter	18 dB/octave @ 100 Hz
1/8" Stereo Channel	
Low	±15 dB @ 80 Hz
Mid	±15 dB @ 2.5 kHz
High	±15 dB @ 12 kHz

#### Maximum Voltage Gain (EQ Flat)

Mic Input Channel to	
Insert Output	60 dB
1/4" Main Output	80 dB
XLR Main Output	86 dB
1/4" Sub Output	80 dB
Aux Output (Pre-Fader)	80 dB
Aux Output (Post-Fader)	90 dB
FX Send	90 dB
FX Send [ProFX10v3]	80 dB
USB Output	70 dB
Mono Line Input Channel to	
Insert Output	40 dB
1/4" Main Output	60 dB
XLR Main Output	66 dB
1/4" Sub Output	60 dB
Aux Output (Pre-Fader)	60 dB
Aux Output (Post-Fader)	70 dB
FX Send	70 dB
FX Send [ProFX10v3]	60 dB
USB Output	50 dB
Stereo Line Input Channel to	
1/4" Main Output	20 dB
XLR Main Output	26 dB
1/4" Sub Output	20 dB
Aux Output (Pre-Fader)	20 dB
Aux Output (Post-Fader)	30 dB
FX Send	30 dB
FX Send [ProFX10v3]	20 dB
USB Output	10 dB
1/8" Input to	
1/4" Main Output	40 dB
XLR Main Output	46 dB
1/4" Sub Output	40 dB
Aux Output (Pre-Fader)	40 dB
Aux Output (Post-Fader)	50 dB
FX Send	50 dB
FX Send [ProFX10v3]	40 dB
USB Output	30 dB
USB Input to	
XLR Main Output	46 dB

<sup>1</sup>ProFX6v3, ProFX10v3, ProFX12v3

<sup>2</sup>ProFX16v3, ProFX22v3, ProFX30v3



## ProFXv3 Specifications continued...

### Digital Effects

Number of Presets	24
Favorite Preset	25 [drats!]

### Meters

Main L/R Mix	
ProFX6v3 – Two columns of 8 segments each:	
OL, +14, +8, +4, 0 (0 dBu), -4, -12, -24	
All other ProFXv3 mixers – Two columns of 12 segments each:	
OL, +15, +10, +6, +3, 0 (0 dBu), -2, -4, -7, -10, -20, -30	

### USB

Format	USB 2.0
I/O	1 Stereo Input, 2 Stereo Outputs
A/D/A	24 bit, 44.1 kHz, 48 kHz, 96 kHz, 192 kHz

### Phantom Power

48 VDC to all Mic channels simultaneously

### AC Power Requirements

Power Consumption	30 watts (ProFX12v3) 40 watts (ProFX16v3) 45 watts (ProFX22v3) 50 watts (ProFX30v3)
Universal AC Power Supply	100 – 240 VAC, 50 – 60 Hz
Power Connector	
ProFX6v3, ProFX10v3	12VDC @ 2A Class I Hard-Wired Wall Mount Adapter
ProFX12v3, ProFX16v3, ProFX22v3, ProFX30v3	3 Pin IEC Line Cord

### Physical Dimensions and Weight

ProFX6v3	
Height	2.8 in / 71 mm
Width	7.5 in / 191 mm
Depth	8.4 in / 213 mm
Weight	2.6 lb / 1.2 kg
ProFX10v3	
Height	3.2 in / 81 mm
Width	10.7 in / 272 mm
Depth	11.9 in / 302 mm
Weight	4.9 lb / 2.2 kg
ProFX12v3	
Height	3.9 in / 99 mm
Width	13.0 in / 330 mm
Depth	14.8 in / 376 mm
Weight	7.9 lb / 3.6 kg

ProFX16v3	
Height	4.3 in / 109 mm
Width	17.7 in / 450 mm
Depth	17.1 in / 434 mm
Weight	15.2 lb / 6.9 kg

ProFX22v3	
Height	4.3 in / 109 mm
Width	24.1 in / 612 mm
Depth	17.1 in / 434 mm
Weight	19.8 lb / 9.0 kg

ProFX30v3	
Height	4.3 in / 109 mm
Width	32.3 in / 820 mm
Depth	17.1 in / 434 mm
Weight	26.5 lb / 12.0 kg

### Options

ProFX6v3	Carry Bag	P/N 2051719
ProFX10v3	Carry Bag Dust Cover	P/N 2051720 P/N 2051726
ProFX12v3	Carry Bag Dust Cover Rack Ear Kit	P/N 2051721 P/N 2051727 P/N 2051623
ProFX16v3	Carry Bag Dust Cover Rack Ear Kit	P/N 2051722 P/N 2051728 P/N 2051634
ProFX22v3	Carry Bag Dust Cover	P/N 2051723 P/N 2051729
ProFX30v3	Dust Cover	P/N 2051730

LOUD Audio, LLC is always striving to improve our products by incorporating new and improved materials, components, and manufacturing methods. Therefore, we reserve the right to change these specifications at any time without notice.

The "Running Man" is a registered trademark of LOUD Audio, LLC. All other brand names mentioned are trademarks or registered trademarks of their respective holders, and are hereby acknowledged.

Please check our website for any updates to this manual: [www.mackie.com](http://www.mackie.com).

©2019 LOUD Audio, LLC. All Rights Reserved.

## ProFX6v3 Dimensions

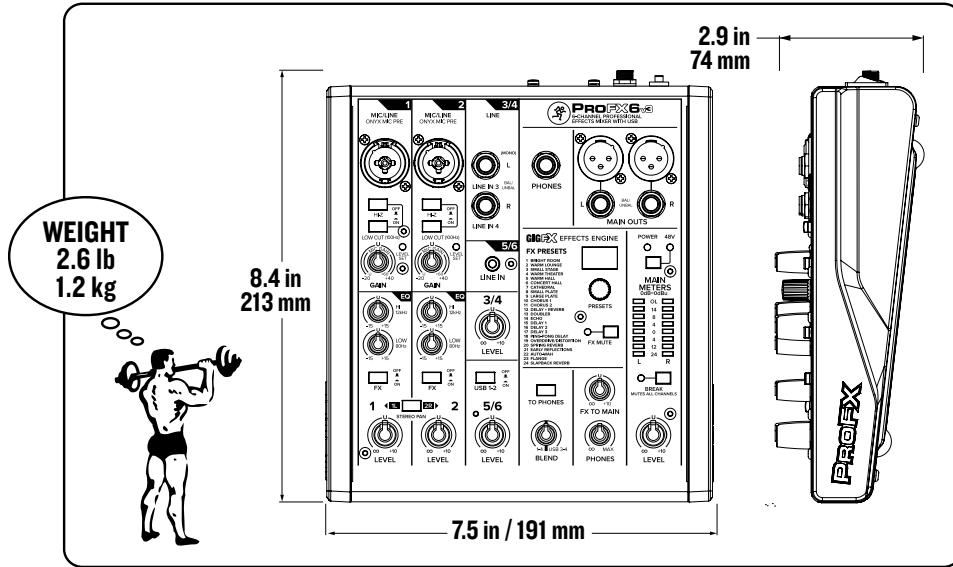

## ProFX10v3 Dimensions

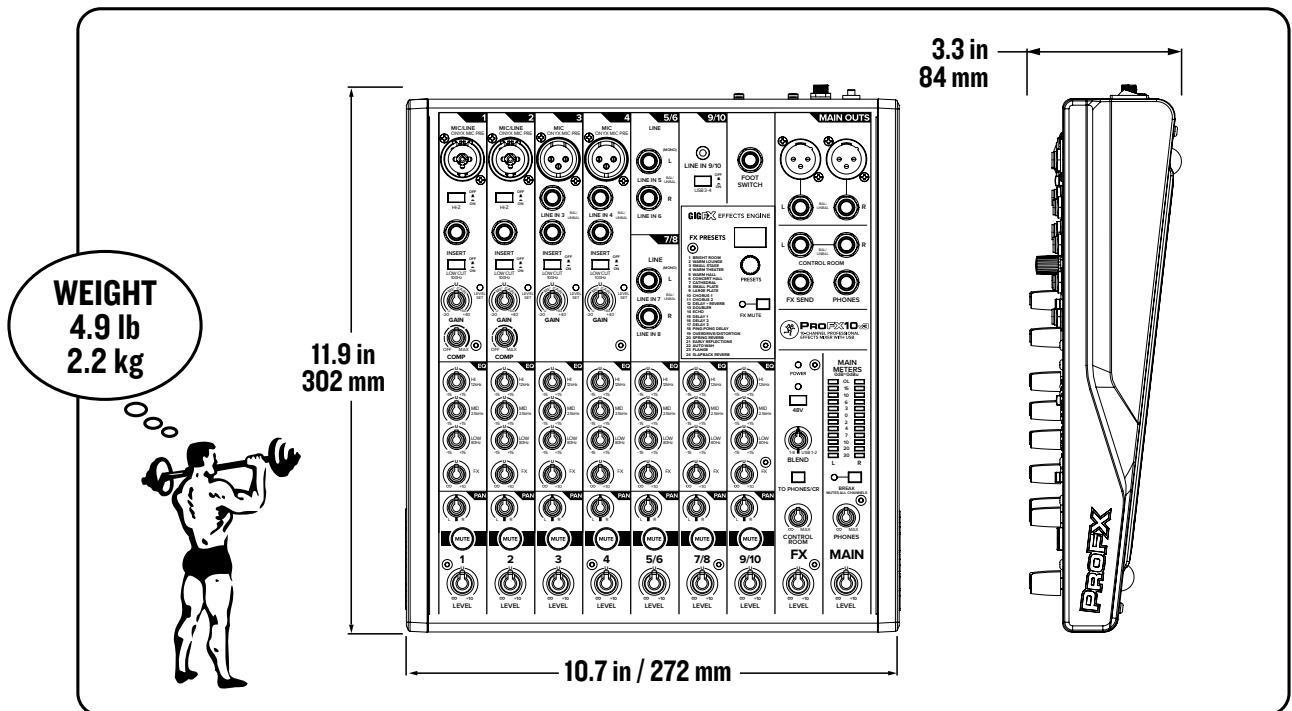

## ProFX12v3 Dimensions

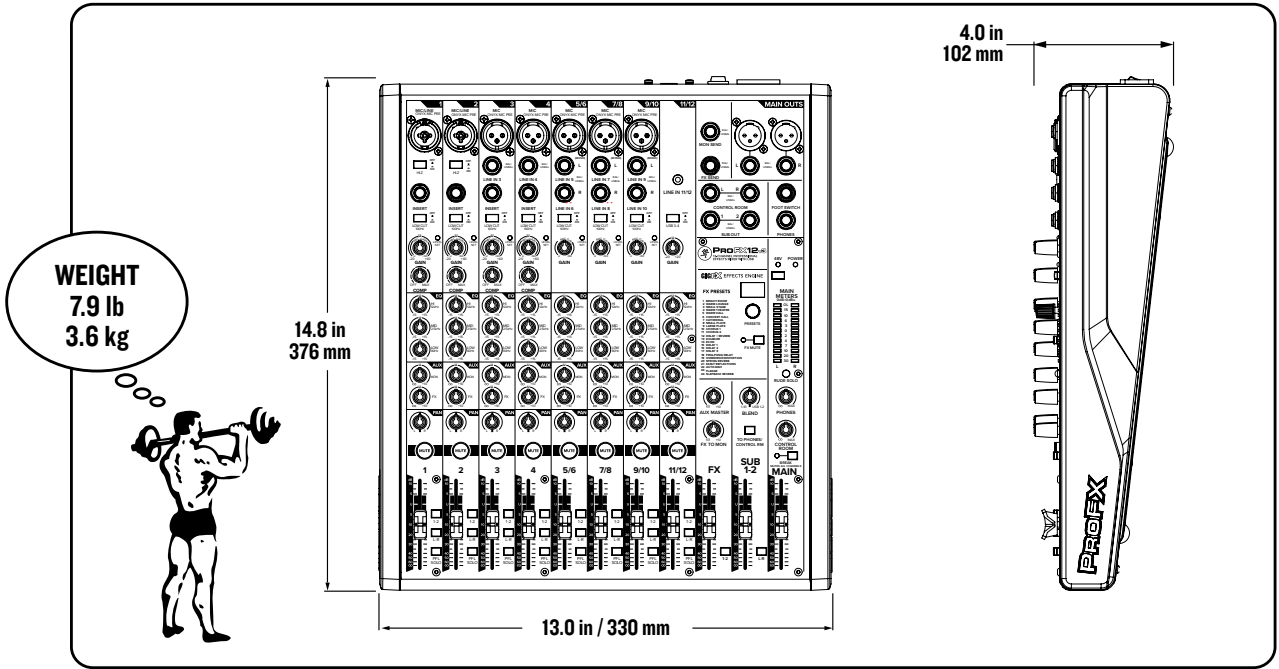

## ProFX16v3 Dimensions

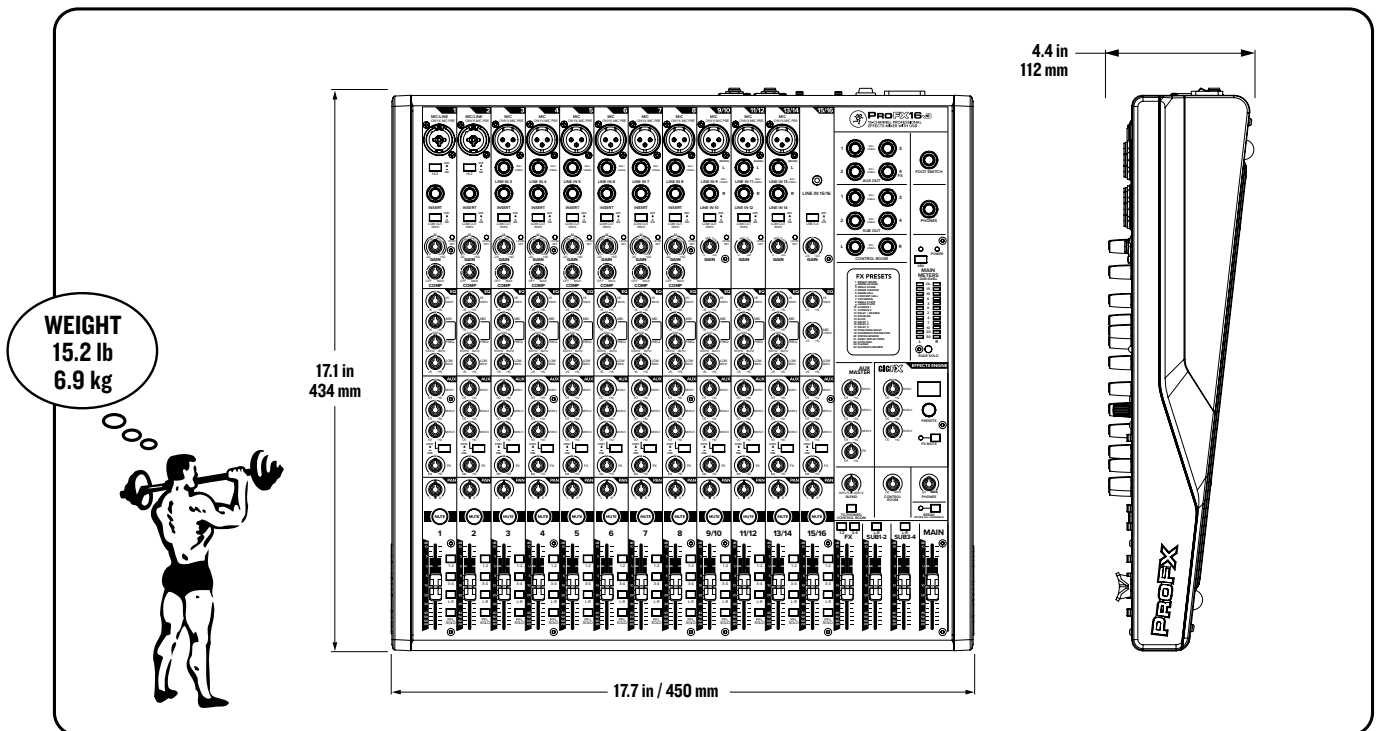

# ProFX22v3 Dimensions

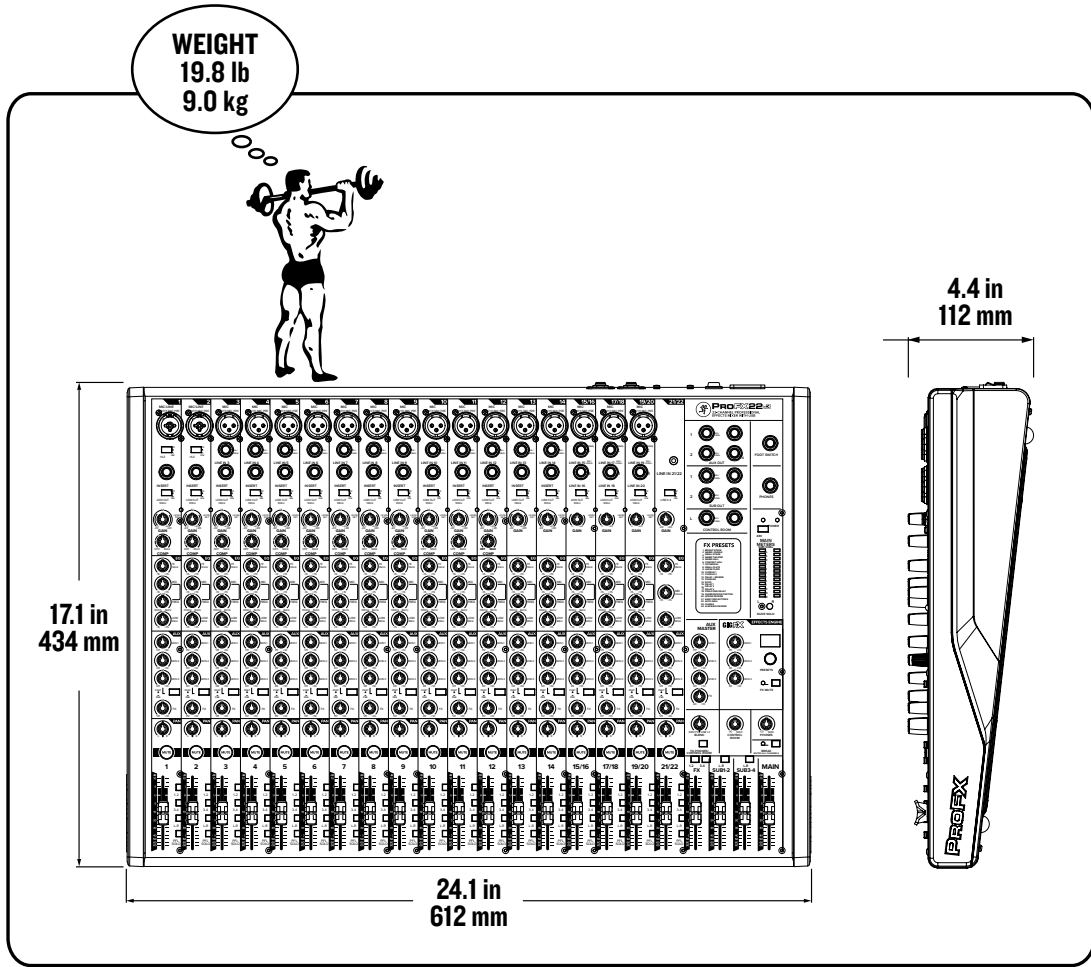

# ProFX30v3 Dimensions

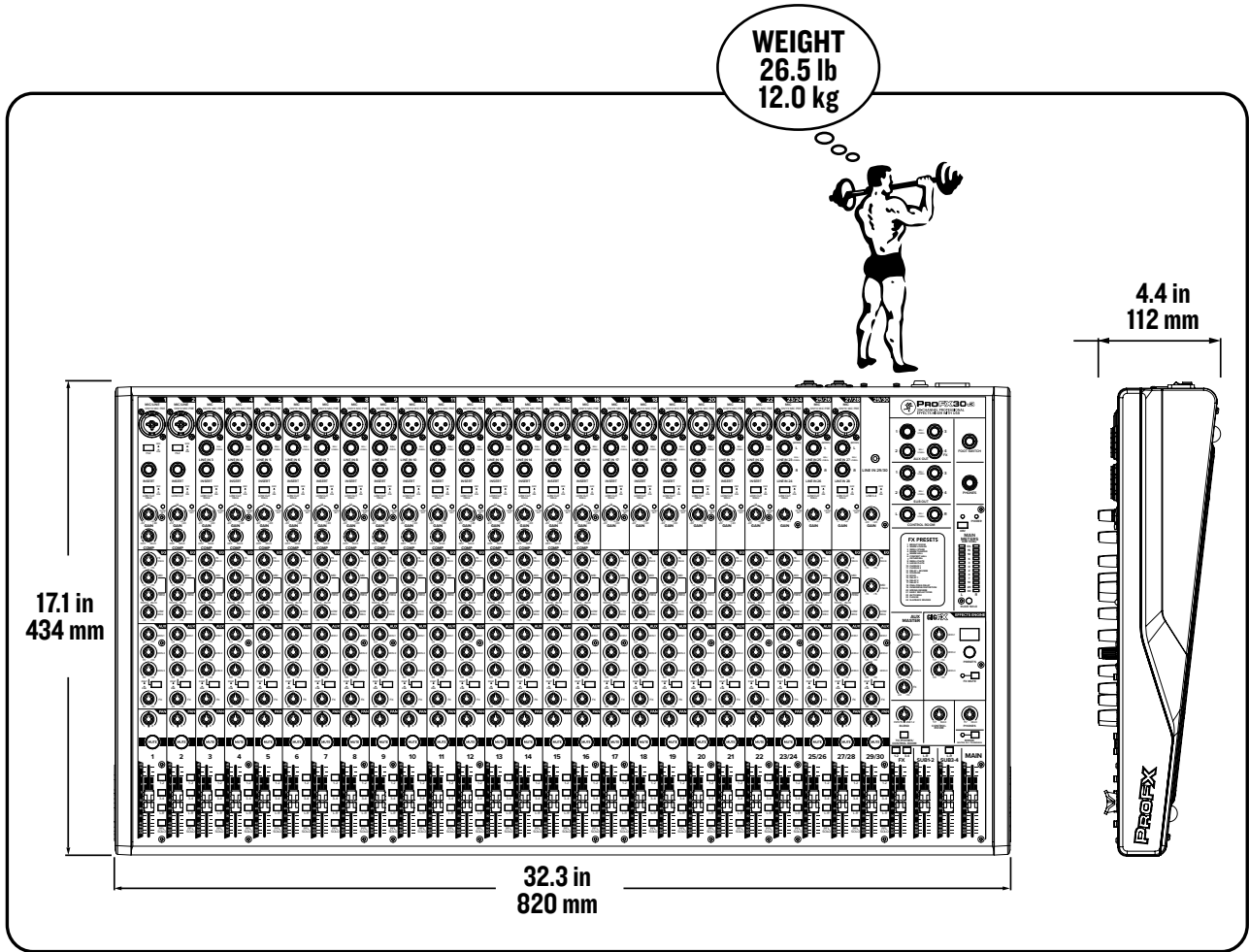

## ProFX6v3 Block Diagram

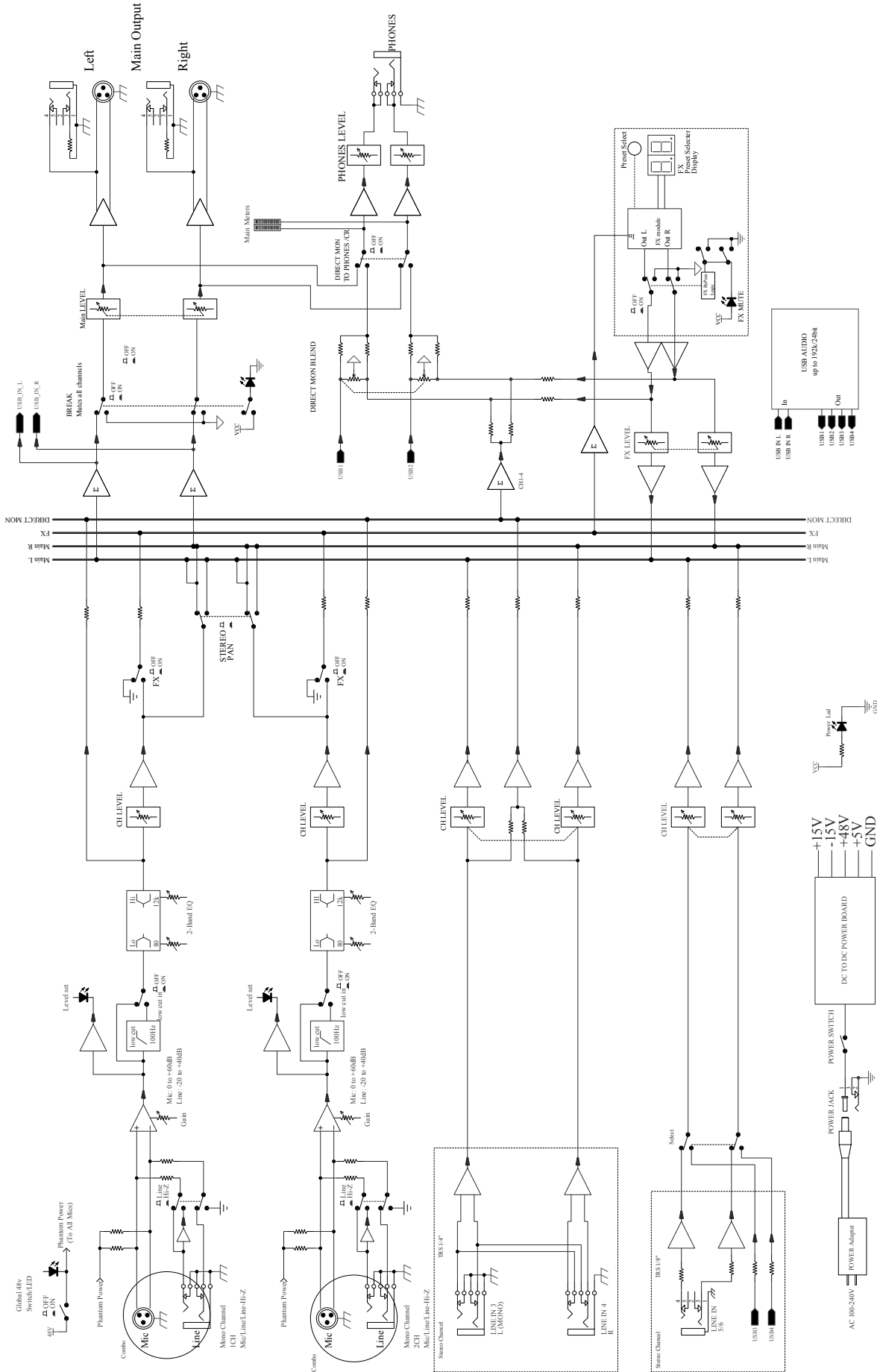

Note: Switch are shown in the default (out) position

# ProFX10v3 Block Diagram

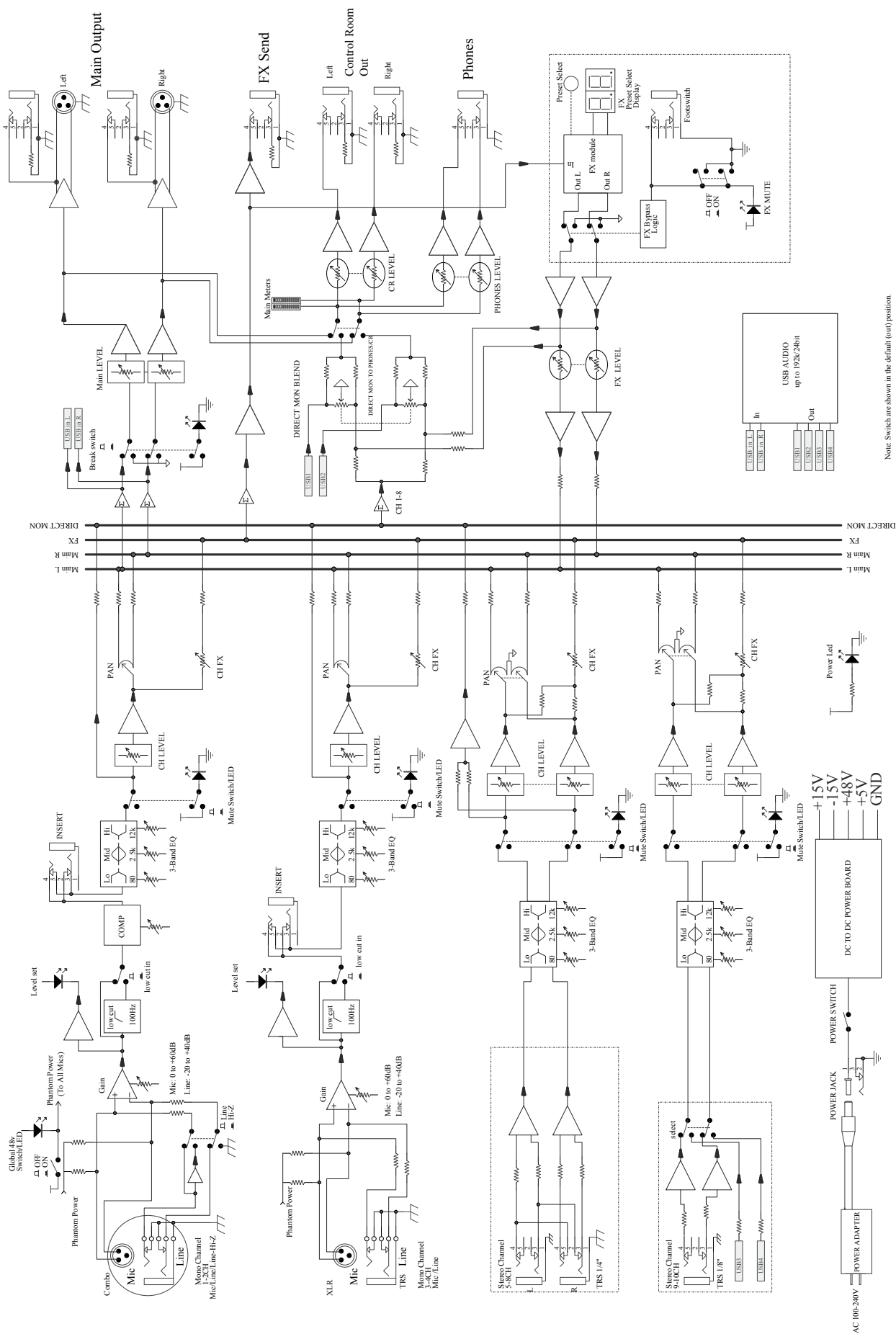

Note: Switches are shown in the default (out) position.

## ProFX12v3 Block Diagram

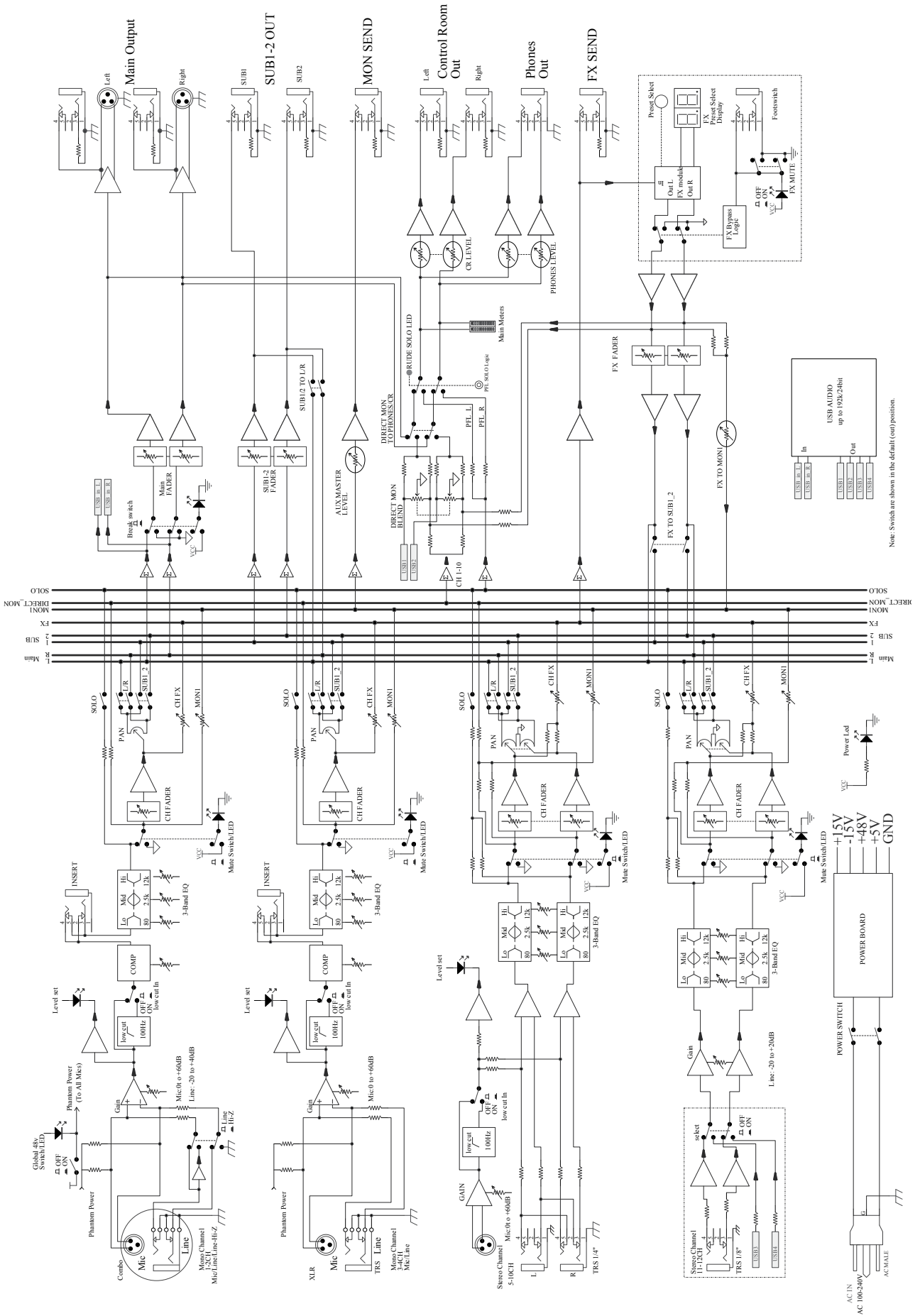



# ProFX16v3 • ProFX22v3 • ProFX30v3 Block Diagram

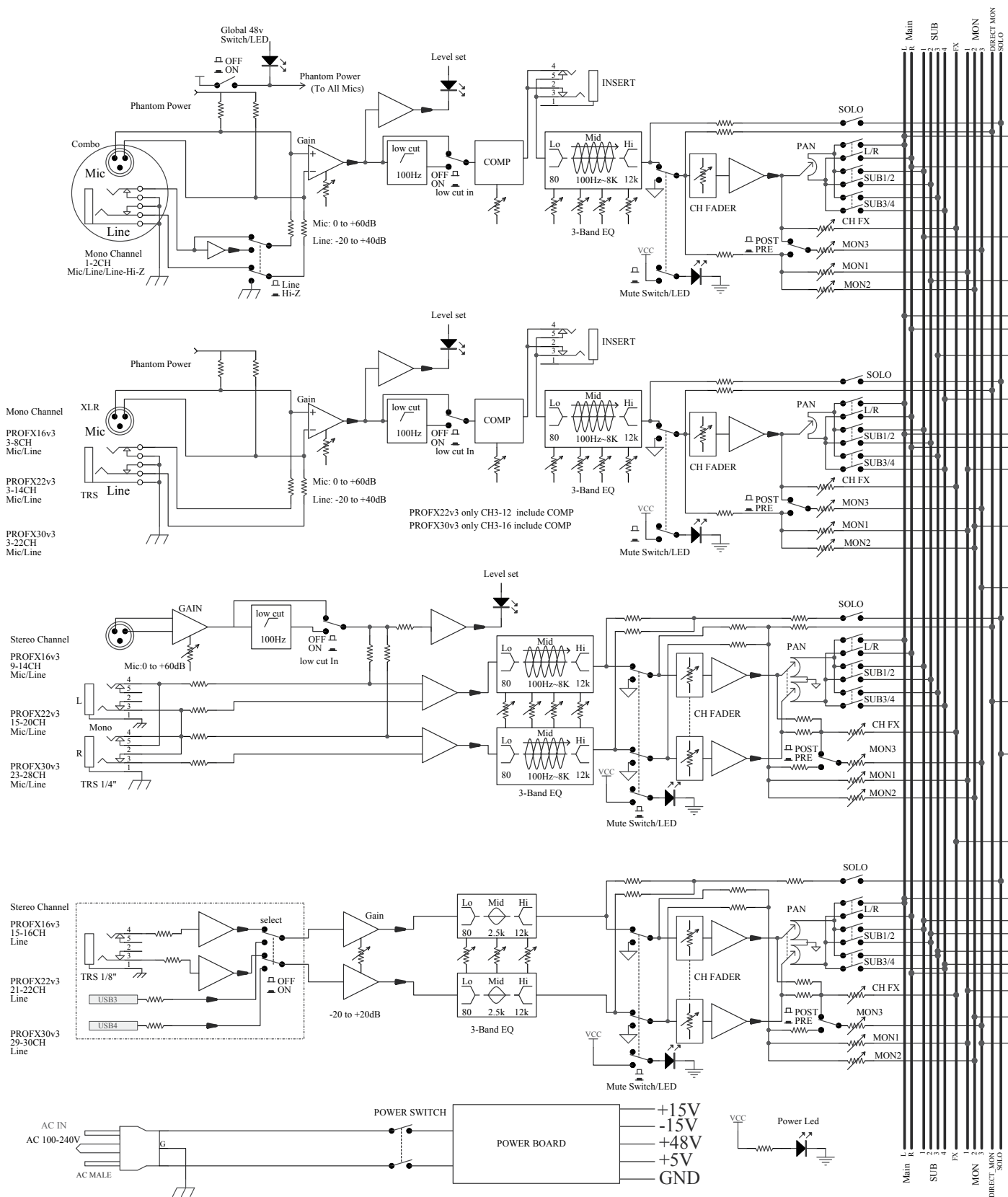

# ProFX16v3 • ProFX22v3 • ProFX30v3 Block Diagram

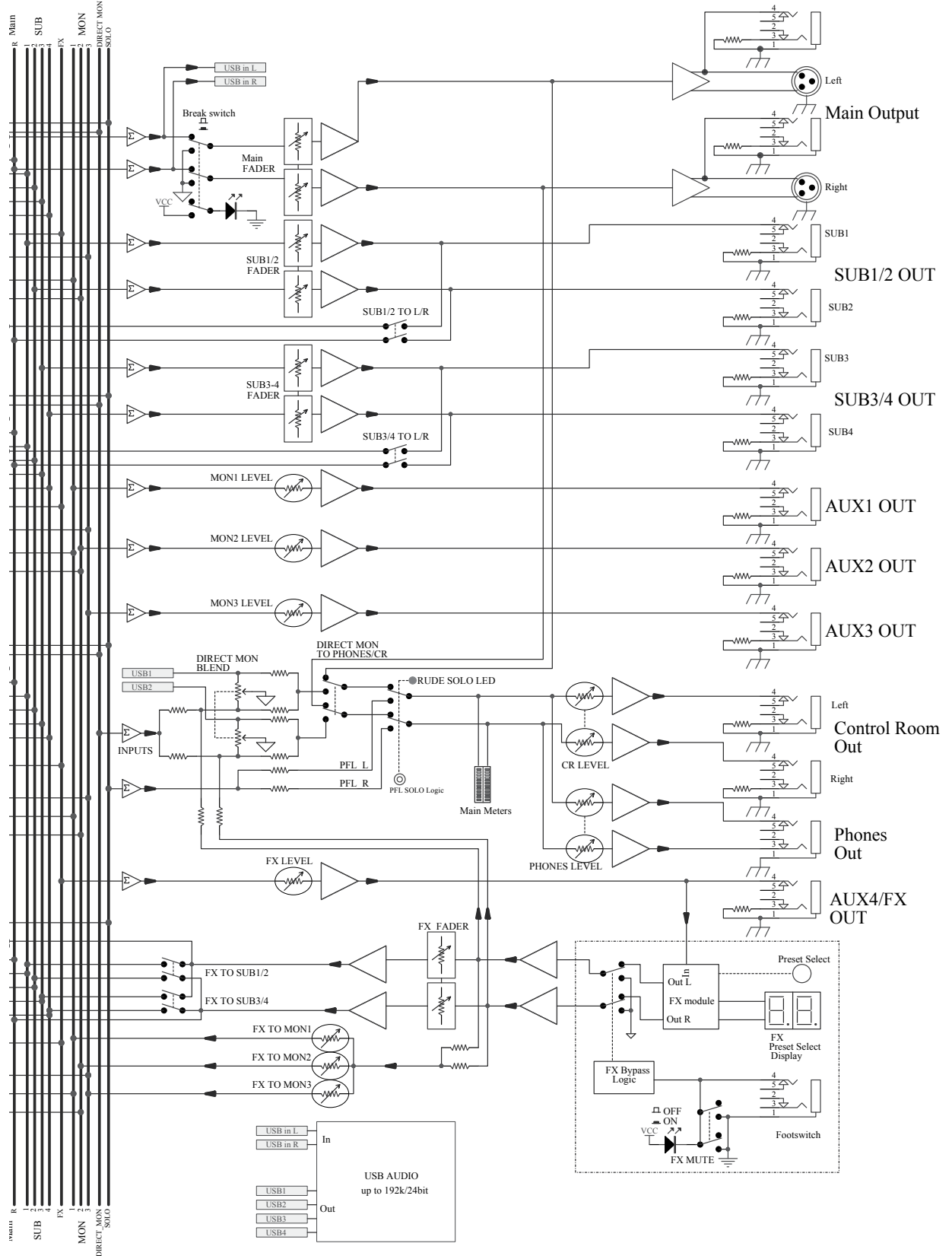

Note: Switch are shown in the default (out) position.

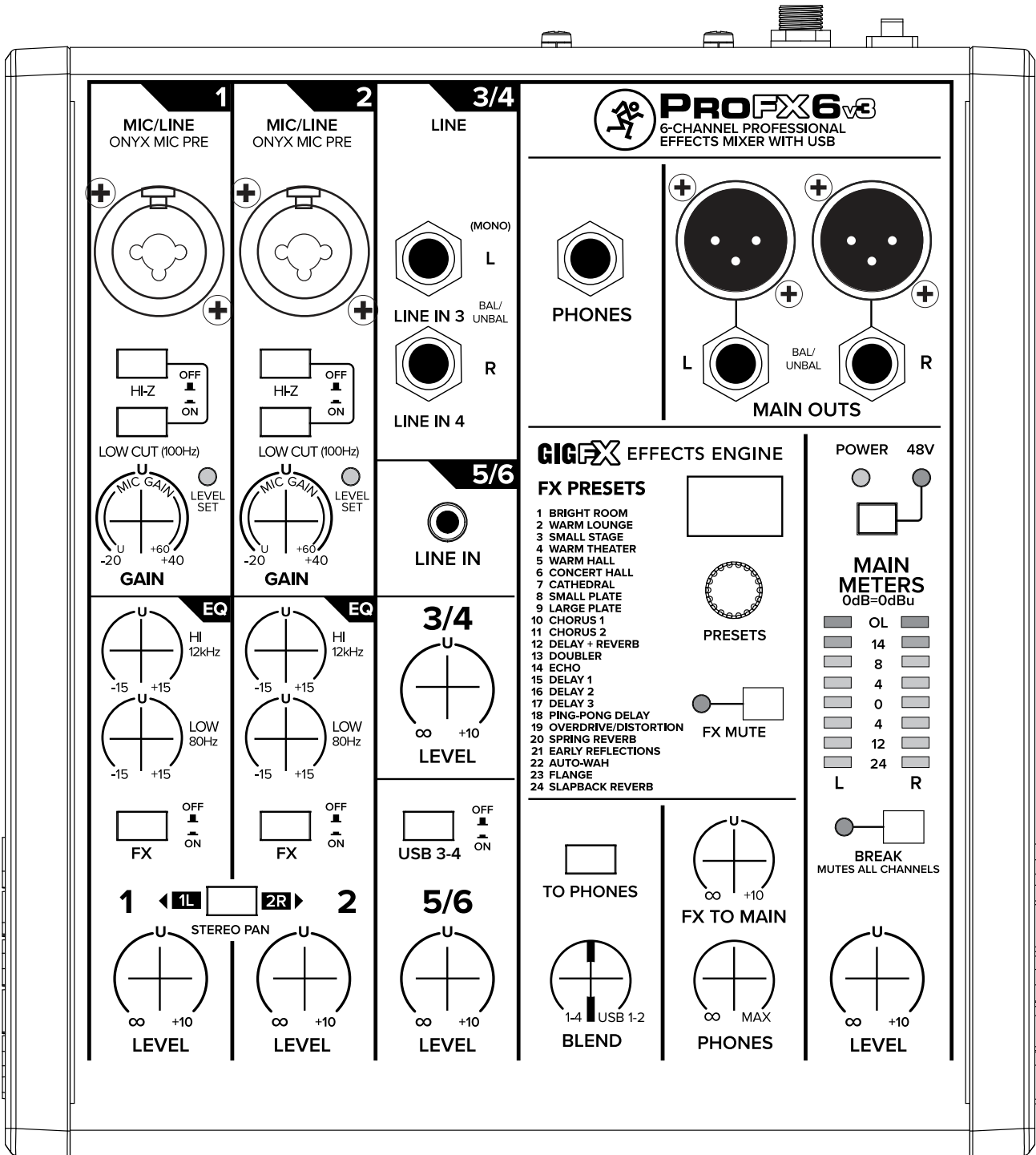

# ProFX10v3 Track Sheet

The diagram illustrates the track sheet of the ProFX10v3 mixer, organized into several functional sections:

- Channels 1-10:** Each channel features a MIC/LINE input with ONYX MIC PRE, HI-Z, and INSERT options. Channels 1-4 have a LOW CUT 100Hz filter. Channels 1-4 also include MIC GAIN, GAIN, and COMP controls. Channels 5-10 are LINE inputs with BAL/UNBAL options. Channels 5-6 have a 7/8 input, and channels 9-10 have a 9/10 input. Each channel has an EQ section with HI (12kHz), MID (2.5kHz), and LOW (80Hz) filters, an FX section, a PAN control, a MUTE button, and a LEVEL control.
- GIGAFX EFFECTS ENGINE:** A central section containing a list of 24 FX PRESETS (e.g., BRIGHT ROOM, WARM LOUNGE, SMALL STAGE, WARM THEATER, WARM HALL, CONCERT HALL, CATHEDRAL, SMALL PLATE, LARGE PLATE, CHORUS 1, CHORUS 2, DELAY + REVERB, DOUBLER, ECHO, DELAY 1, DELAY 2, DELAY 3, PING-PONG DELAY, OVERDRIVE/DISTORTION, SPRING REVERB, EARLY REFLECTIONS, AUTO-WAH, FLANGE, SLAPBACK REVERB), a PRESETS knob, and an FX MUTE button.
- MAIN OUTS:** Includes two stereo outputs with BAL/UNBAL options, a CONTROL ROOM output, an FX SEND output, and a PHONES output. It also features a POWER switch, a 48V phantom power switch, a BLEND knob (1-8 USB 1-2), a TO PHONES/CR switch, and a BREAK MUTES ALL CHANNELS button.
- MAIN METERS:** A vertical strip of meters for OL, 15, 10, 6, 3, 0, 2, 4, 7, 10, 20, and 30 dB, with L and R indicators.

**Channel 1-12 Controls:**

- MIC/LINE ONYX MIC PRE
- HFZ ON/OFF
- INSERT OFF/ON
- LOW CUT 100Hz OFF/ON
- MIC GAIN LEVEL SET
- COMP
- EQ (HI 12kHz, MID 2.5kHz, LOW 80Hz)
- AUX MON FX PAN
- MUTE

**Right Side Controls:**

- MAIN OUTS (BAL/UNBAL)
- MON SEND
- FX SEND
- CONTROL ROOM (L, R)
- FOOT SWITCH
- SUB OUT (1, 2)
- PHONES
- 48V POWER
- GIGAFLEX EFFECTS ENGINE
- FX PRESETS (24 presets list)
- PRESETS
- FX MUTE
- AUX MASTER
- BLEND
- TO PHONES/CONTROL RM
- SUB 1-2
- MAIN METER (dB)

**FX PRESETS LIST:**

- BRIGHT ROOM
- WARM LOUNGE
- SMALL STAGE
- WARM THEATER
- WARM HALL
- CONCERT HALL
- CATHEDRAL
- SMALL PLATE
- LARGE PLATE
- CHORUS 1
- CHORUS 2
- DELAY + REVERB
- DOUBLER
- ECHO
- DELAY 1
- DELAY 2
- DELAY 3
- PING-PONG DELAY
- OVERDRIVE/DISTORTION
- SPRING REVERB
- EARLY REFLECTIONS
- AUTO-WAH
- FLANGE
- SLAPBACK REVERB

# ProFX16v3 • ProFX22v3 • ProFX30v3 Track Sheet

1	2	3	4	5	6	7	8	9	10	11	12	13	14	15	
MIC/LINE ON/YX MIC PRE	MIC/LINE ON/YX MIC PRE	MIC ON/YX MIC PRE	MIC ON/YX MIC PRE	MIC ON/YX MIC PRE	MIC ON/YX MIC PRE	MIC ON/YX MIC PRE	MIC ON/YX MIC PRE	MIC ON/YX MIC PRE	MIC ON/YX MIC PRE	MIC ON/YX MIC PRE	MIC ON/YX MIC PRE	MIC ON/YX MIC PRE	MIC ON/YX MIC PRE	MIC ON/YX MIC PRE	MIC ON/YX MIC PRE
1-Hz	1-Hz	LINE IN 3	LINE IN 4	LINE IN 5	LINE IN 6	LINE IN 7	LINE IN 8	LINE IN 9	LINE IN 10	LINE IN 11	LINE IN 12	LINE IN 13	LINE IN 14	LINE IN 15	
INSERT	INSERT	INSERT	INSERT	INSERT	INSERT	INSERT	INSERT	INSERT	INSERT	INSERT	INSERT	INSERT	INSERT	INSERT	INSERT
LOW CUT 100Hz	LOW CUT 100Hz	LOW CUT 100Hz	LOW CUT 100Hz	LOW CUT 100Hz	LOW CUT 100Hz	LOW CUT 100Hz	LOW CUT 100Hz	LOW CUT 100Hz	LOW CUT 100Hz	LOW CUT 100Hz	LOW CUT 100Hz	LOW CUT 100Hz	LOW CUT 100Hz	LOW CUT 100Hz	LOW CUT 100Hz
GAIN	GAIN	GAIN	GAIN	GAIN	GAIN	GAIN	GAIN	GAIN	GAIN	GAIN	GAIN	GAIN	GAIN	GAIN	GAIN
COMP	COMP	COMP	COMP	COMP	COMP	COMP	COMP	COMP	COMP	COMP	COMP	COMP	COMP	COMP	COMP
EQ	EQ	EQ	EQ	EQ	EQ	EQ	EQ	EQ	EQ	EQ	EQ	EQ	EQ	EQ	EQ
AUX	AUX	AUX	AUX	AUX	AUX	AUX	AUX	AUX	AUX	AUX	AUX	AUX	AUX	AUX	AUX
PAN	PAN	PAN	PAN	PAN	PAN	PAN	PAN	PAN	PAN	PAN	PAN	PAN	PAN	PAN	PAN
MUTE	MUTE	MUTE	MUTE	MUTE	MUTE	MUTE	MUTE	MUTE	MUTE	MUTE	MUTE	MUTE	MUTE	MUTE	MUTE
1	2	3	4	5	6	7	8	9	10	11	12	13	14	15	
1-2	1-2	1-2	1-2	1-2	1-2	1-2	1-2	1-2	1-2	1-2	1-2	1-2	1-2	1-2	1-2
L-R	L-R	L-R	L-R	L-R	L-R	L-R	L-R	L-R	L-R	L-R	L-R	L-R	L-R	L-R	L-R
PFL SOLO	PFL SOLO	PFL SOLO	PFL SOLO	PFL SOLO	PFL SOLO	PFL SOLO	PFL SOLO	PFL SOLO	PFL SOLO	PFL SOLO	PFL SOLO	PFL SOLO	PFL SOLO	PFL SOLO	PFL SOLO

# ProFX16v3 • ProFX22v3 • ProFX30v3 Track Sheet

**PROFX30v3**  
30-CHANNEL PROFESSIONAL EFFECTS MIXER WITH USB

**Channels 16-30:** Each channel includes a MIC ONYX MIC PRE input, LINE IN, INSERT, LOW CUT 100Hz, GAIN, EQ (HI 12kHz, MID 600Hz, FREQ, LOW 80Hz), AUX (MON1-3, FX), PAN, and MUTE controls.

**Effects Engine:** Includes FX PRESETS (1-24), AUX MASTER, and GIGAFX EFFECTS ENGINE with MON1-3, PRESETS, and FX MUTE controls.

**Monitoring:** Includes MAIN METERS (48V, 0dB, OL, 15, 20, 30, 40, 50, 60, 70, 80, 90, 100), PHONES, and CONTROL ROOM meters.

**Outputs:** Includes AUX OUT (1-4), SUB OUT (L-R), and MAIN outputs (1-2, 3-4, L-R).

**Other Features:** Includes FOOT SWITCH, PHONES, POWER, and a BREAK MUTES ALL CHANNELS button.

## Appendix C: Table of Effects Presets

No.	Title	Description	Example of its use
01	Bright Room	This room has a bright tone with lots of scattered reflections to simulate harder, more reflective surfaces.	Useful on vocals that require a brighter reverb to cut through the mix, or for giving acoustic instruments a livelier vibe.
02	Warm Lounge	This preset features a medium sized room sound, with just enough enhancement of the lower mids to produce a warm tone.	Useful for vocals on songs that require a larger, more "wet" sound, or for giving dimension to bright horns without adding harshness.
03	Small Stage	This preset simulates the sound of a small concert stage, with a medium reverb time and reverberant space.	Useful for vocals or guitars in fast paced, high-energy songs that call for a "live" sounding reverberation.
04	Warm Theater	This reverb has a warm bodied tone and medium long reverb time to simulate the live acoustics of a theater space.	Perfect for vocals, drums, acoustic and electric guitars, keyboards and more.
05	Warm Hall	This reverb simulates the sound of a spacious, yet cozy, heavily draped and carpeted concert hall with an especially warm tone.	Perfect for adding natural concert hall ambience to close-mic'ed orchestral instruments.
06	Concert Hall	This hall reverb is characterized by its large, spacious sound, long pre-delay, and vibrant tone.	Adds life to acoustic instruments and vocals from solos to full-on symphonies and choirs.
07	Cathedral	This reverb emulates the extremely long tails, dense diffusion and long pre-delays and reflections that would be found in a very large, stone walled house of worship.	Gives amazing depth to choirs, wind instruments, organs and soft acoustic guitars.
08 09	Small Plate Large Plate	These presets emulate vintage mechanical reverberation that was generated with a metal plate. Its sound is characterized by lots of early reflections and no pre-delay.	Perfect for thickening percussive instruments, such as a snare drum, or tight vocal arrangements.
10 11	Chorus 1 Chorus 2	These presets provide a soft, ethereal sweeping effect that is useful for thickening and for making a particular sound pop out of the mix.	Perfect for enhancement of electric and acoustic guitar and bass, or to add a dramatic effect to vocals, particularly group harmonies and choirs.
12	Delay + Reverb	Don't choose delay, don't choose reverb! Get the best of both worlds with effects preset #12!	Useful for bands that employ the alternative rock, shoegaze and/or experimental rock sound.
13	Doubler	This effect simulates the sound of a vocal or instrument being recorded twice (double-tracked) on a multi-track recorder.	Provides a vibe that is similar to chorus without the subtle swirl.
14	Echo	A single-repeat echo, not as fast as the Doubler. This effect provides a single, relatively rapid delay of the original signal, with the added warmth that vintage tape-based echo units provided.	Also known as Slap Back Echo, use it to make a vocal or guitar stand out in the mix without extra volume.
15 16 17	DLY 1 (Fast) DLY 2 (Med) DLY 3 (Slow)	These three presets provide delay with delay times of fast, medium and slow.	These work best with full, up-beat music like rock where the delay needs to cut through the mix.
18	Ping-Pong Delay	The ping-pong delay works by producing a bouncing sound as the delayed signal bounces from left to right, with the feedback routed to the opposite channels.	A guitarist may choose the ping-pong delay to create an interesting – and steady – delay.
19	Overdrive / Distortion	This effect increases the gain, resulting in a "fuzzy" – overdriven / distorted – tone.	Useful in many situations, but typically used with guitar, bass, piano / keyboard.
20	Spring Reverb	A spring reverb uses a transducer at one end of a spring and a pickup at the other end to create and capture vibrations in a metal spring. The longer the spring, the longer the decay time of the reverberation.	Spring reverbs are typically used on guitar amplifiers or organs in a rock band format.
21	Early Reflections	Early reflection is the sound that appears after one or two reflections from the venue's walls, ceilings and floor.	Because of its "quickness", the early reflections FX is a great way to create a stereo sound from a mono source.
22	Auto-Wah	This effect adjusts a peaking filter that amplifies a specific frequency, thereby cutting off all other frequencies. Like a guitar player's wah pedal... but automatic!	Mostly used on guitars, bass and piano... but feel free to experiment!
23	Flange	The flange effect is a modulated delay with feedback (and shorter delay times than a chorus), which creates the characteristic "whooshing" sound often used to describe the flange sound.	Check out Heart's "Barracuda"!
24	Slapback Reverb	This effect provides a single, relatively rapid delay of the original signal with no feedback.	Slapback reverb is generally used to mimic vocals – and sometimes drums – on '50s-era rock 'n roll.



## Limited Warranty

### **Please keep your sales receipt in a safe place.**

This Limited Product Warranty ("Product Warranty") is provided by LOUD Audio, LLC ("LOUD") and is applicable to products purchased in the United States or Canada through a LOUD-authorized reseller or dealer. The Product Warranty will not extend to anyone other than the original purchaser of the product (hereinafter, "Customer," "you" or "your").

For products purchased outside the U.S. or Canada, please visit [www.mackie.com](http://www.mackie.com) to find contact information for your local distributor, and information on any warranty coverage provided by the distributor in your local market.

LOUD warrants to Customer that the product will be free from defects in materials and workmanship under normal use during the Warranty Period. If the product fails to conform to the warranty then LOUD or its authorized service representative will at its option, either repair or replace any such nonconforming product, provided that Customer gives notice of the noncompliance within the Warranty Period to the Company at: [www.mackie.com](http://www.mackie.com) or by calling LOUD technical support at 1.800.898.3211 (toll-free in the U.S. and Canada) during normal business hours Pacific Time, excluding weekends or LOUD holidays. Please retain the original dated sales receipt as evidence of the date of purchase. You will need it to obtain any warranty service.

For full terms and conditions, as well as the specific duration of the Warranty for this product, please visit [www.mackie.com](http://www.mackie.com).

The Product Warranty, together with your invoice or receipt, and the terms and conditions located at [www.mackie.com](http://www.mackie.com) constitutes the entire agreement, and supersedes any and all prior agreements between LOUD and Customer related to the subject matter hereof. No amendment, modification or waiver of any of the provisions of this Product Warranty will be valid unless set forth in a written instrument signed by the party to be bound thereby.

### **Need help with the mixer?**

- Visit [www.mackie.com/support](http://www.mackie.com/support) to find: FAQs, manuals, addendums, and other documents.
- Email us at: [www.mackie.com/support-contact](http://www.mackie.com/support-contact)
- Telephone 1-800-898-3211 to speak with one of our splendid technical support chaps (Monday through Friday, normal business hours, Pacific Time).



---

**19820 North Creek Parkway #201  
Bothell, WA 98011 • USA  
Phone: 425.487.4333  
Toll-free: 800.898.3211  
Fax: 425.487.4337  
[www.mackie.com](http://www.mackie.com)**

---