

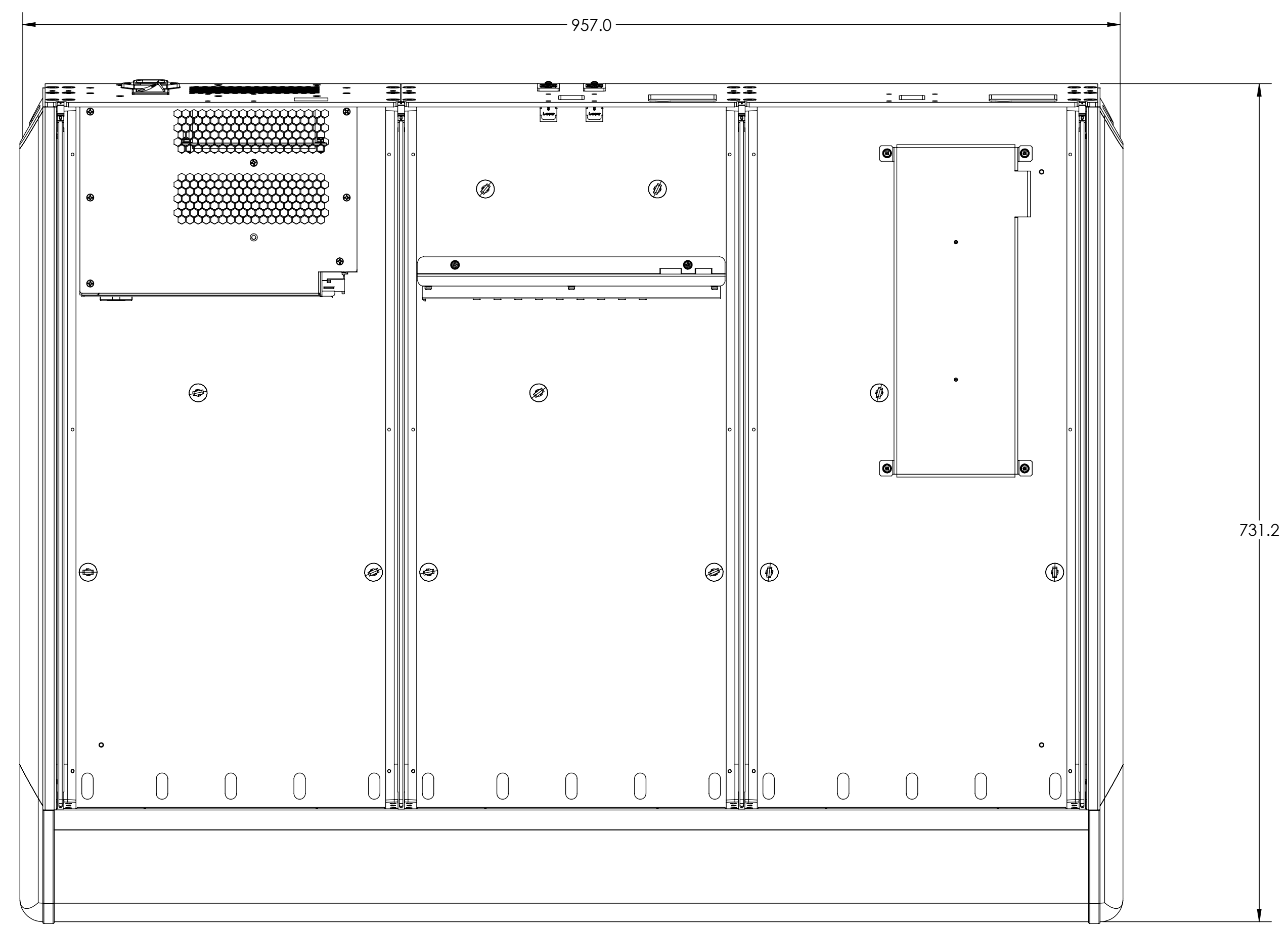

INFORMATION AND SPECIFICATIONS CONTAINED HEREIN ARE CONFIDENTIAL AND PROPRIETARY. THEY ARE THE PROPERTY OF AVID TECHNOLOGY INC., AND SHALL NOT BE REPRODUCED OR COPIED OR USED IN WHOLE OR IN PART FOR ANY REASON WITHOUT WRITTEN PERMISSION. THIS IS AN UNPUBLISHED WORK PROTECTED UNDER FEDERAL COPYRIGHT LAWS.

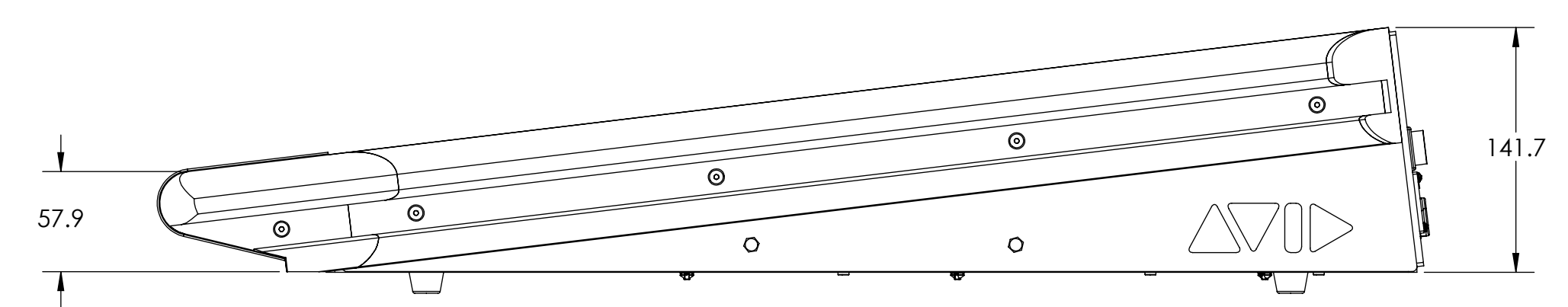

FRAME DIMENSIONS WITH SIDE TRIM

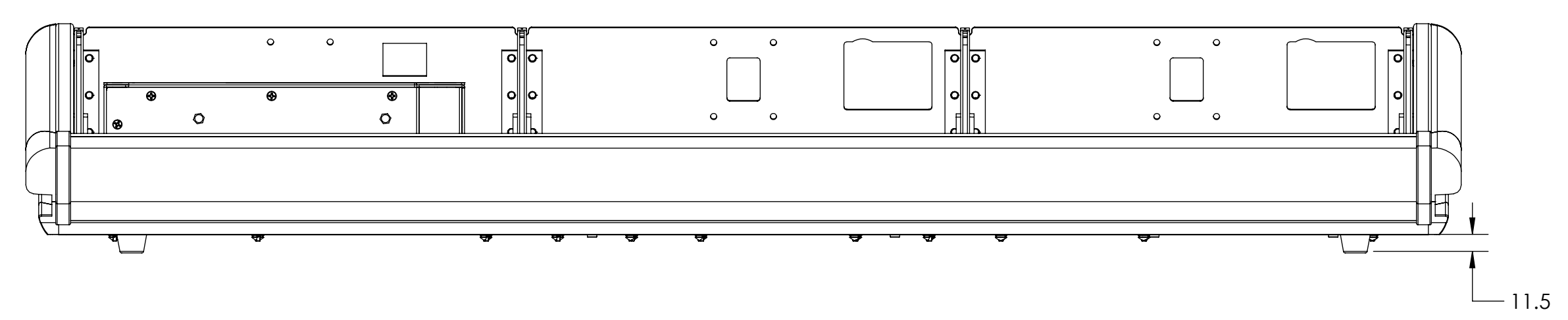

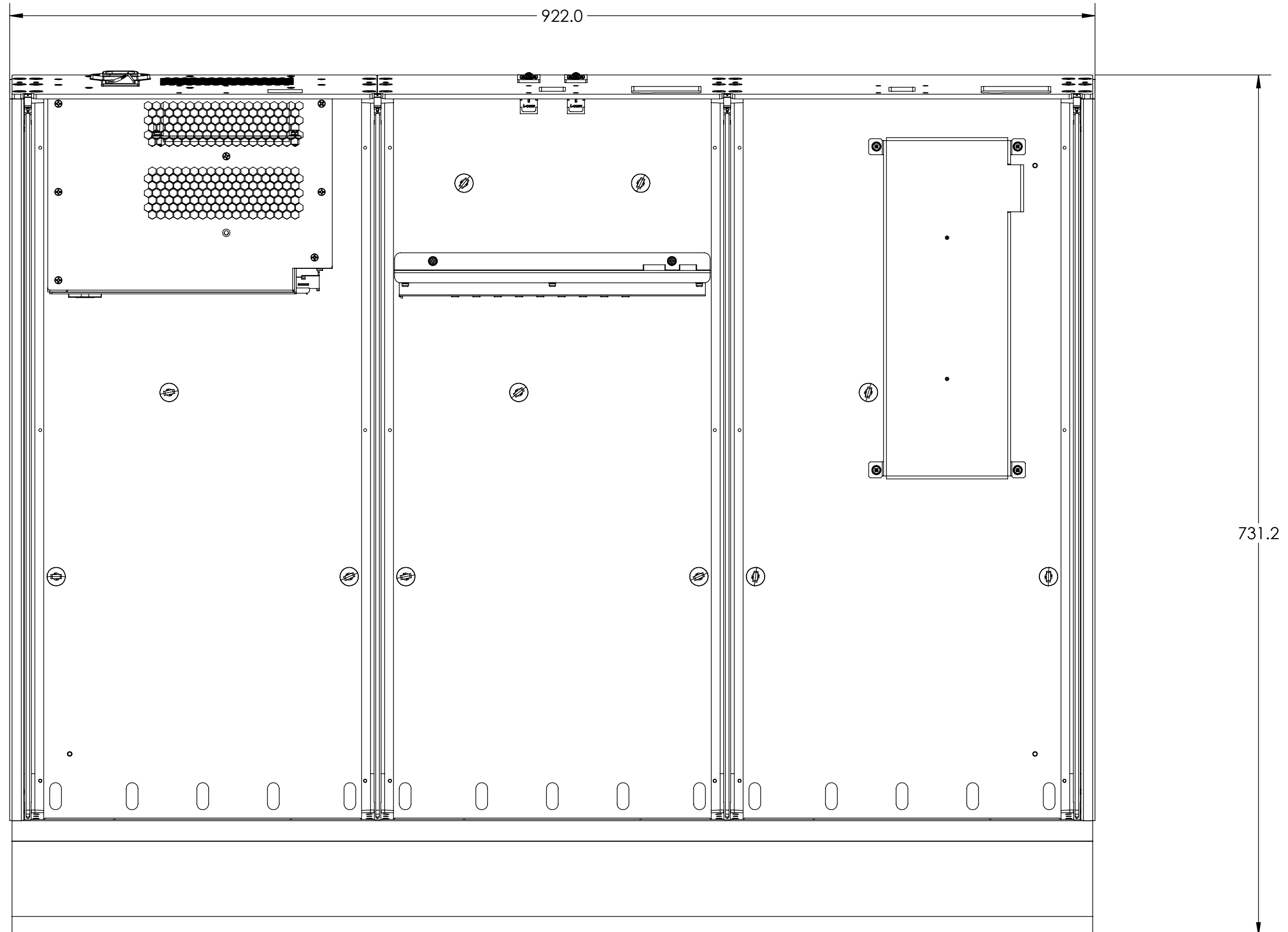

		75 NETWORK DRIVE BURLINGTON, MA. 01803	
TITLE: DWG MECH ASY, FNL, 3BAY, FRAME, S4			
PART NUMBER 7602-30989-00		REV. B	
SIZE: D	SHEET: 13 OF 14		

INFORMATION AND SPECIFICATIONS CONTAINED HEREIN ARE CONFIDENTIAL AND PROPRIETARY. THEY ARE THE PROPERTY OF AVID TECHNOLOGY INC., AND SHALL NOT BE REPRODUCED OR COPIED OR USED IN WHOLE OR IN PART FOR ANY REASON WITHOUT WRITTEN PERMISSION. THIS IS AN UNPUBLISHED WORK PROTECTED UNDER FEDERAL COPYRIGHT LAWS.

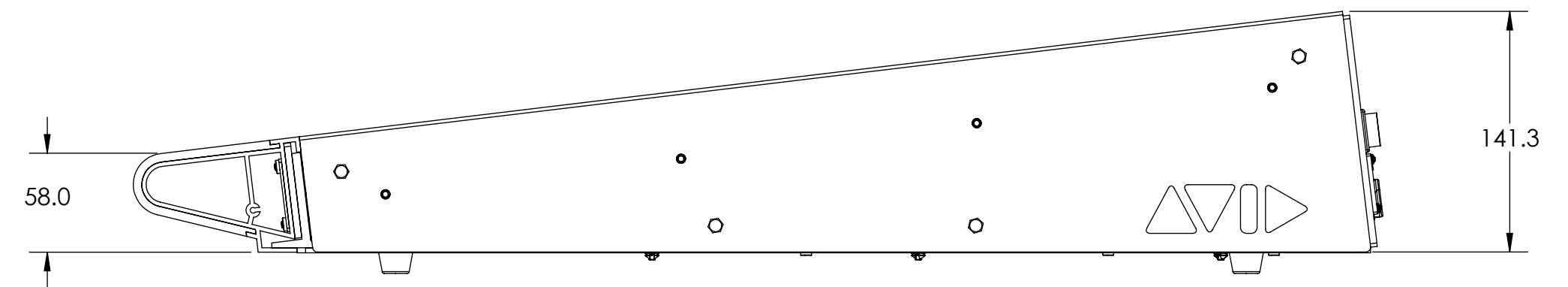
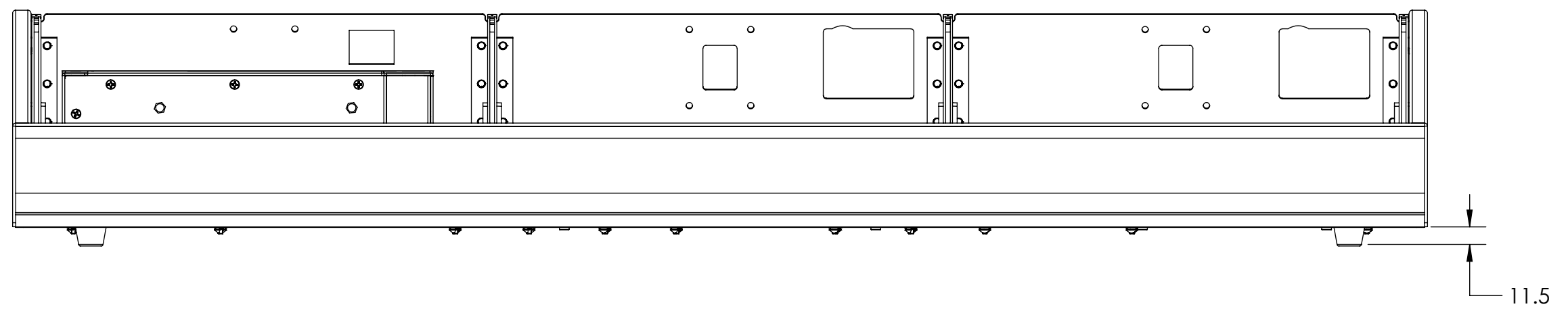

FRAME DIMENSIONS
WITHOUT SIDE TRIM



		75 NETWORK DRIVE BURLINGTON, MA. 01803	
TITLE: DWG MECH ASY, FNL, 3BAY, FRAME, S4			
PART NUMBER 7602-30989-00		REV. B	
SIZE: D	SHEET: 14 OF 14		