

UPM-1XP UltraCompact Wide-Coverage Loudspeaker

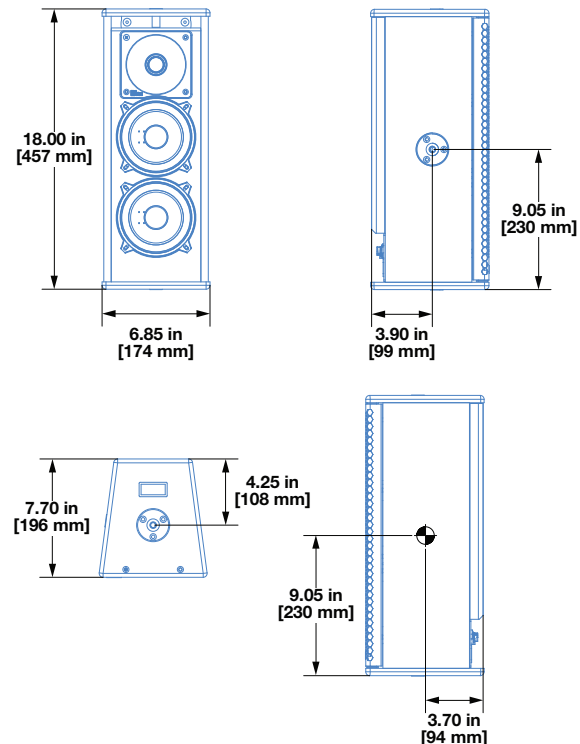
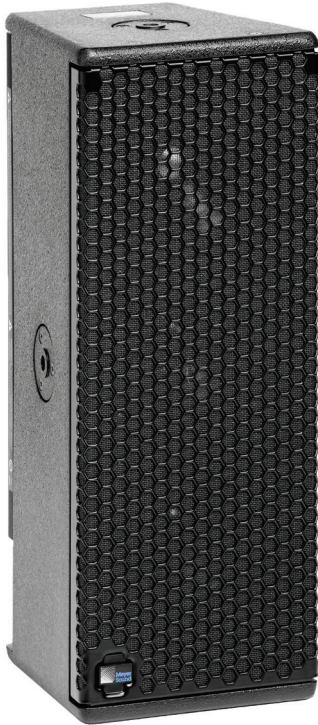

The UPM-1XP, with IntelligentDC technology, is a compact, externally-powered, wide-coverage loudspeaker for professional sound reinforcement. It offers the same high sound pressure levels, low distortion, and uniform directional control as the UPM-1P but with the added flexibility of external DC power—enabling lengthy cable runs without AC conduits. Ideal usage of the UPM-1XP is for applications requiring wide-coverage in a small, inconspicuous cabinet where AC cabling is not feasible.

As a standalone loudspeaker, use the UPM-1XP for vocal reinforcement, frontfill coverage, or delay coverage for under-balcony applications. For full-range systems, pair the UPM-1XP with Meyer Sound's UMS-1XP ultracompact subwoofer with IntelligentDC technology.

The UPM-1XP's high-frequency section includes a 1-inch metal dome tweeter on a constant-directivity, high-frequency horn with a 100° beamwidth. The low/mid-frequency section includes two 5-inch cone transducers that work in parallel at low frequencies—delivering a combined acoustic output—with one of the drivers rolling off above 320 Hz to prevent interference in the crossover region due to comb filtering effects. A three-channel amplifier, which includes active crossover, driver protection, and frequency and phase correction circuitry, powers the proprietary drivers that Meyer Sound manufactures at its factory in Berkeley, California.

With IntelligentDC technology, the UPM-1XP receives DC power and balanced audio from a single loudspeaker connector, available as Phoenix™ 5-pin male, sealed SwitchCraft® EN3™ 5-pin male, or sealed ECO-M 7-pin male. Powering the unit from an external

source eliminates the need for wiring conduits while still preserving the advantages of self-powered systems. The UPM-1XP's amplifier and signal-processing circuits store DC power and tolerate voltage drops, thereby accommodating light-gauge cables and lengthy cable runs.

The UPM-1XP requires a Meyer Sound IntelligentDC external power supply. For larger installations, the single-space rack-mount MPS-488HP IntelligentDC power supply unit distributes DC power and balanced audio to up to eight UPJunior-XP loudspeakers or other Meyer Sound IntelligentDC loudspeakers. For smaller installations, the MPS-482HP IntelligentDC power supply offers two channels of audio and DC power. Composite multiconductor cables, such as Belden® 1502 or equivalent, can deliver both DC power and balanced audio to loudspeakers at cable lengths up to 150 feet with just 1 dB of loss in peak SPL using 18 AWG wire. Longer cable runs are possible with heavier gauge wires.

Meyer Sound's RMS™ remote monitoring system, which offers comprehensive monitoring of loudspeaker parameters from a Mac® or Windows®-based computer running Compass® control software, is optionally available for the MPS-488HP.

Meyer Sound coats the UPM-1XP cabinet with a slightly textured black finish and includes three threaded, recessed nut plates (3/8 in-16 or metric M10). Optional rigging hardware includes the MYA-UPM mounting yoke, MUB-UPM U-bracket, and MSA-UPM stand adapter. Other UPM-1XP options include weather protection and custom color finishes for fixed installations and installations with specific cosmetic requirements.

FEATURES AND BENEFITS

- IntelligentDC technology affords the flexibility of lengthy cable runs without AC conduits
- Extraordinary fidelity and power capability delivered in an ultracompact package
- Metal dome tweeter provides a smooth high-frequency response
- Wide, symmetrical pattern covers a broad listening area
- Unique crossover design eliminates combing and yields a consistent midrange response
- Exceptional SPL to size ratio supports a variety of applications

APPLICATIONS

- Frontfill and under-balcony fill coverage
- Theatrical sound reinforcement
- Portable and installed AV systems
- Houses of worship
- Compact voice reinforcement systems

ACCESSORIES AND ASSOCIATED PRODUCTS

MUB-UPM U-Bracket: Allows a UPM-1XP loudspeaker to be mounted to a wall (in either vertical or horizontal orientations), to the ceiling or on the floor.

MYA-UPM Yoke: Cradle-style mounting yoke that suspends a single UPM-1XP loudspeaker and supports a wide range of horizontal and vertical adjustment. The yoke attaches to the top and bottom nut plates and includes 3/8-inch-16 and M10 hardware.

MSA-UPM Stand Adapter: Mount the UPM-1XP loudspeaker on a stand using the MSA-UPM stand adapter along with a third-party loudspeaker stand. The MSA-UPM kit includes 3/8-inch-16 and M10 hardware.

MPK-POLE 35MM Adjustable Pole: Pole with adjustable length of 32–55 in, 35 mm diameter; includes a 38 mm adapter to be used with 38 mm stand adapters.

Galileo GALAXY Network Platform: The Galileo GALAXY Network Platform provides state-of-the-art audio control technology for loudspeaker systems with multiple zones. With immaculate sonic performance, it provides a powerful tool set for corrective room equalization and creative fine-tuning for a full range of applications.

MPS-488HP External Power Supply: Rack-mount unit that delivers balanced audio and high-current DC power to up to eight loudspeakers; versions available with either Phoenix or EN3 channel output connectors.

MPS-482HP External Power Supply: 1RU 1/2 width rack unit that delivers balanced audio and high-current DC power to up to two audio channels; rack mount or use available options to mount on ceiling, wall, pole or truss configurations.

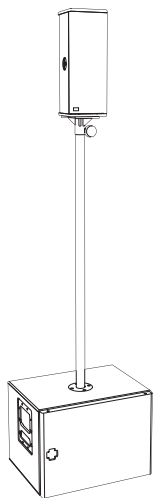

MPK-POLE 35MM Adjustable Pole

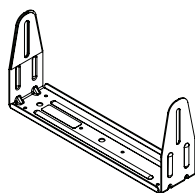

MUB-UPM U-Bracket

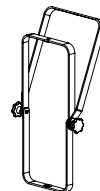

MYA-UPM Yoke

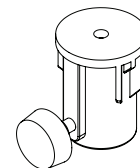

MSA-UPM Stand Adapter



GALAXY Network Platform

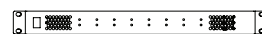

MPS-488HP External Power Supply

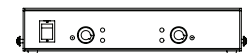

MPS-482HP External Power Supply

SPECIFICATIONS

ACOUSTICAL ¹			
Operating Frequency Range ²	75 Hz – 20 kHz		
Frequency Response ³	80 Hz – 16 kHz \pm 4 dB		
Phase Response	300 Hz – 18 kHz \pm 60 degrees		
Linear Peak SPL ⁴	118.5 dB with crest factor >14 dB (M-noise) , 113 dB (Pink noise), 115.5 (B-noise)		
COVERAGE			
Horizontal Coverage	100°		
Vertical Coverage	100°		
TRANSDUCERS			
Low Frequency	Two 5-inch cone drivers; 8 Ω nominal impedance		
High Frequency	One 1-inch metal dome tweeter; 8 Ω nominal impedance		
AUDIO INPUT			
Type	Differential, electronically balanced		
Maximum Common Mode Range	\pm 15 V DC, clamped to earth for voltage transient protection		
Connectors	Phoenix 5-pin Male; SwitchCraft 5-pin Male; ECO-M 7-pin Male (two pins for 48 V DC power, three pins for balanced audio)		
Input Impedance	10 k Ω differential between positive (+) and negative (-) audio pins		
Wiring ⁵	Phoenix 5-pin Male Pin 1: DC Power (-) Pin 2: DC Power (+) Pin 3: Chassis/earth through 1 k Ω , 1000 pF, 15 V clamp network to provide virtual ground lift at audio frequencies Pin 4: Audio (-) Pin 5: Audio (+)	SwitchCraft EN3 5-pin Male Pin 1: DC Power (-) Pin 2: DC Power (+) Pin 3: Chassis/earth through 1 k Ω , 1000 pF, 15 V clamp network to provide virtual ground lift at audio frequencies Pin 4: Audio (-) Pin 5: Audio (+)	ECO-M 7-pin Male ⁵ Pin 1: DC Power (-) Pin 2: DC Power (+) Pin S: Chassis/earth through 1 k Ω , 1000 pF, 15 V clamp network to provide virtual ground lift at audio frequencies Pin 5: Audio (-) Pin 6: Audio (+)
Nominal Input Sensitivity	-8.0 dBV (0.4 V rms) continuous average is typically the onset of limiting for noise and music		
Input Level	Audio source must be capable of producing of +20 dBV (10 V rms) into 600 Ω to produce the maximum peak SPL over the operating bandwidth of the loudspeaker.		
AMPLIFIER			
Type	3-channel, class D		
Total Output Power ⁶	650 W peak		
THD, IM, TIM	< 0.02%		
Cooling	Convection		
DC POWER			
Connector	Phoenix 5-pin Male; SwitchCraft 5-pin Male; ECO-M 7-pin Male (two pins for 48 V DC power, three pins for balanced audio)		
Safety Rated Voltage Range	48 V DC		
RMS NETWORK (OPTIONAL)			
	Equipped with two-conductor twisted-pair network, reporting all operating parameters of amplifiers to system operator's host computer.		

SPECIFICATIONS, CONT'D.

PHYSICAL	
Dimensions	W: 6.85 in (174 mm) x H: 18.00 in (457 mm) x D: 7.70 in (196 mm)
Weight	17 lb (7.7 kg)
Enclosure	Premium multi-ply birch with slightly textured black finish
Protective Grille	Powder-coated, hex-stamped steel with black mesh
Rigging	Three 3/18-inch-16 or metric M10 nut plates

NOTES

- Loudspeaker system predictions for coverage and SPL are available in Meyer Sound's MAPP System Design Tool.
- Recommended maximum operating frequency range. Response depends on loading conditions and room acoustics.
- Free-field, measured with 1/3 octave frequency resolution at 4 m.
- Linear Peak SPL** is measured in free-field at 4 m referred to 1 m. Loudspeaker SPL compression measured with M-noise at the onset of limiting, 2-hour duration, and 50-degree C ambient temperature is < 2 dB.

M-noise is a full bandwidth (10 Hz–22.5 kHz) test signal developed by Meyer Sound to better measure the loudspeaker's music performance. It has a constant instantaneous peak level in octave bands, a crest factor that increases with frequency, and a full bandwidth Peak to RMS ratio of 18 dB. The presence of a greater-than (>) symbol with regard to crest factor indicates it may be higher depending on EQ and boundary loading.

Pinknoise is a full bandwidth test signal with Peak to RMS ratio of 12.5 dB.

B-noise is a Meyer Sound test signal used to ensure measurements reflect system behavior when reproducing the most common input spectrum, and to verify there is still headroom over pink noise.

- Pins 3 and 4 not used in ECO-M connector.
- Peak power based on the maximum unclipped peak voltage the amplifier will produce into the nominal load impedance.

ARCHITECTURAL SPECIFICATIONS

The loudspeaker shall be a self-powered, full-range system. Its transducers shall include two 5-inch cone drivers and one 1-inch metal dome tweeter.

The loudspeaker system shall incorporate internal processing and a three-channel amplifier, one channel for each driver. Processing functions shall include equalization, phase correction, signal division, and driver protection. Amplifier burst output power shall be 650 W total. Distortion (THD, IM, TIM) shall not exceed 0.02%.

Performance specifications for a typical production unit shall be as follows: operating frequency range, 75 Hz–20 kHz; phase response, 300 Hz–18 kHz $\pm 60^\circ$; linear peak SPL is 118.5 dB with crest factor >14 dB, measured with M-noise, free-field at 4 m referred to 1 m; coverage shall be 100° horizontal by 100° vertical.

The loudspeaker shall receive DC power and balanced audio from a single input connector, available as Phoenix 5-pin male, sealed EN3 5-pin

male, or sealed ECO-M 7-pin male (two pins for DC power, three pins for balanced audio). The audio input shall be electronically balanced with a 10 k Ω impedance and accept a nominal –8.0 dBV (0.4 V rms) input signal.

Power requirements for the loudspeaker shall be a Meyer Sound IntelligentDC power supply capable of delivering 48 V DC.

All components shall be mounted in an acoustically vented trapezoidal enclosure constructed of premium multi-ply birch with a slightly textured black finish. The protective grille shall be powder-coated, hex-stamped steel with black mesh screen. Rigging shall be three 3/8-inch-16 or M10 nut plates. Dimensions shall be W: 6.85 in (174 mm) x H: 18.00 in (457 mm) x D: 7.70 in (196 mm). Weight shall be 17 lb (7.7 kg).

The loudspeaker shall be the Meyer Sound UPM-1XP