

## PowerShot G7X Mark II

### Camera User Guide

- Make sure you read this guide, including the “Safety Precautions” (14) section, before using the camera.
  - Reading this guide will help you learn to use the camera properly.
  - Store this guide safely so that you can use it in the future.
- Click the buttons in the lower right to access other pages.
    - ▶: Next page
    - ◀: Previous page
    - 🔗: Page before you clicked a link
  - To jump to the beginning of a chapter, click the chapter title at right.

Before Use

Basic Guide

Advanced Guide

Camera Basics

Auto Mode /  
Hybrid Auto Mode

Other Shooting Modes

P Mode

Tv, Av, M, and C Mode

Playback Mode

Wi-Fi Functions

Setting Menu

Accessories

Appendix

Index

ENGLISH

# Before Use

## Package Contents

Before use, make sure the following items are included in the package. If anything is missing, contact your camera retailer.

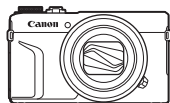

Camera



Battery Pack  
NB-13L\*

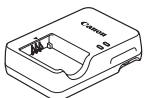

Battery Charger  
CB-2LH/CB-2LHE

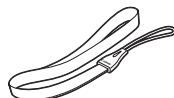

Wrist Strap

\* Do not peel off the adhesive covering from a battery pack.

- Printed matter is also included.
- A memory card is not included (📖2).

## Compatible Memory Cards

The following memory cards (sold separately) can be used, regardless of capacity.

- SD memory cards\*<sup>1</sup>
- SDHC memory cards\*<sup>1\*2</sup>
- SDXC memory cards\*<sup>1\*2</sup>



\*<sup>1</sup> Cards conforming to SD standards. However, not all memory cards have been verified to work with the camera.

\*<sup>2</sup> UHS-I memory cards are also supported.

Before Use

Basic Guide

Advanced Guide

Camera Basics

Auto Mode /  
Hybrid Auto Mode

Other Shooting Modes

P Mode

Tv, Av, M, and C Mode

Playback Mode

Wi-Fi Functions

Setting Menu

Accessories

Appendix

Index



## Preliminary Notes and Legal Information

- Take and review some test shots initially to make sure the images were recorded correctly. Please note that Canon Inc., its subsidiaries and affiliates, and its distributors are not liable for any consequential damages arising from any malfunction of a camera or accessory, including memory cards, that result in the failure of an image to be recorded or to be recorded in a way that is machine readable.
- Images recorded by the camera shall be for personal use. Refrain from unauthorized recording that infringes on copyright law, and note that even for personal use, photography may contravene copyright or other legal rights at some performances or exhibitions, or in some commercial settings.
- The camera warranty is valid only in the area of purchase. In case of camera problems while abroad, return to the area of purchase before contacting a Canon Customer Support Help Desk.
- Although the screen (monitor) is produced under extremely high-precision manufacturing conditions and more than 99.99% of the pixels meet design specifications, in rare cases some pixels may be defective or may appear as red or black dots. This is not a malfunction. This does not affect recorded images either.
- When the camera is used over an extended period, it may become warm. This does not indicate damage.

## Conventions in This Guide

- In this guide, icons are used to represent the corresponding camera buttons and dials on which they appear or which they resemble.
- The following camera buttons and controls are represented by icons. Numbers in parentheses indicate the numbers of corresponding controls in “Part Names” (📖4).
  - 🔘 Control ring (11) on front
  - ⬆️ Up button (9) on back
  - ⬅️ Left button (14) on back
  - ➡️ Right button (11) on back
  - ⬇️ Down button (12) on back
  - 🔘 Control dial (6) on back
- Shooting modes and on-screen icons and text are indicated in brackets.
- ⓘ: Important information you should know
- 📝: Notes and tips for expert camera use
- ✎: Indicates touch-screen operations
- 📖 xx: Pages with related information (in this example, “xx” represents a page number)
- Instructions in this guide apply to the camera under default settings.
- For convenience, all supported memory cards are simply referred to as the “memory card”.
- The symbols “▶ Still Images” and “▶ Movies” below titles indicate how the function is used—whether for still images or movies.

Before Use

Basic Guide

Advanced Guide

Camera Basics

Auto Mode /  
Hybrid Auto Mode

Other Shooting Modes

P Mode

Tv, Av, M, and C Mode

Playback Mode

Wi-Fi Functions

Setting Menu

Accessories

Appendix

Index



## Part Names

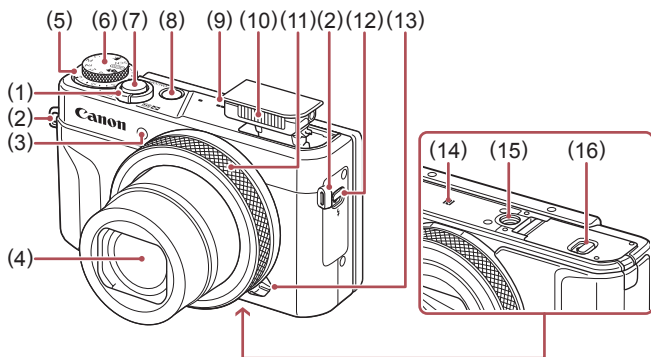

- |   |                                      |
|---|--------------------------------------|
| (1) Zoom lever<br>Shooting: [T] (telephoto) /<br>[W] (wide angle)<br>Playback: [Q] (magnify) /<br>[Z] (index) | (9) Speaker                          |
| (2) Strap mount   | (10) Flash                           |
| (3) Lamp  | (11) Control ring                    |
| (4) Lens  | (12) [Fn] (Flash pop up) switch      |
| (5) Exposure compensation dial  | (13) Step/Continuous selection lever |
| (6) Mode dial   | (14) [N] (N-Mark)*1                  |
| (7) Shutter button  | (15) Tripod socket                   |
| (8) Power button  | (16) Memory card/battery cover       |

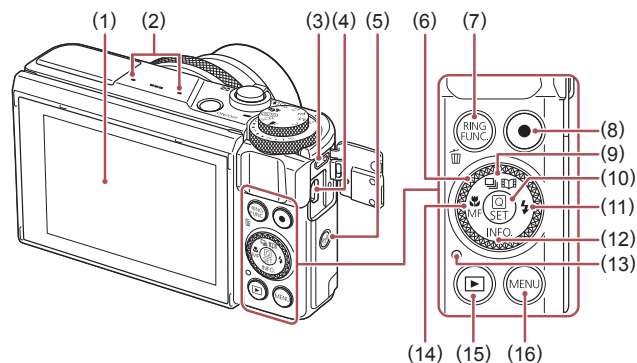

- |   |   |
|---|---|
| (1) Screen (monitor)*2  | (10) [Q] (Quick Set menu/Set) button                |
| (2) Microphone  | (11) [Flash] / Right button                         |
| (3) DIGITAL terminal  | (12) [INFO.] (Information) / Down<br>button         |
| (4) HDMI™ terminal  | (13) Indicator                                      |
| (5) [Wi-Fi] (Wi-Fi) button  | (14) [Macro] / [MF] (Manual<br>focus) / Left button |
| (6) Control dial  | (15) [Play] (Playback) button                       |
| (7) [R.FUNC.] (Ring function selector) /<br>[Erase] (Single-image erase) button | (16) [MENU] (Menu) button                           |
| (8) Movie button  |   |
| (9) [Drive mode] / [Story<br>Highlights] button / Up button                     |   |



- Turning the control dial is one way to choose setting items, switch images, and perform other operations. Most of these operations are also possible with the [▲][▼][◀][▶] buttons.

## Before Use

### Basic Guide

### Advanced Guide

#### Camera Basics

#### Auto Mode / Hybrid Auto Mode

#### Other Shooting Modes

#### P Mode

#### Tv, Av, M, and C Mode

#### Playback Mode

#### Wi-Fi Functions

#### Setting Menu

#### Accessories

#### Appendix

## Index

\*1 Used with NFC features (142).

\*2 Gestures may not be detected as easily if you apply a screen protector. In this case, increase the sensitivity of the touch-screen panel (174).





## Table of Contents

### Before Use

Package Contents .....	2
Compatible Memory Cards .....	2
Preliminary Notes and Legal Information .....	3
Conventions in This Guide .....	3
Part Names .....	4
Common Camera Operations .....	12
Safety Precautions .....	14

### Basic Guide

<b>Basic Operations.....</b>	<b>17</b>
Touch-Screen Operations.....	17
Touching .....	17
Dragging .....	17
Initial Preparations.....	18
Attaching the Strap .....	18
Holding the Camera.....	18
Charging the Battery Pack.....	18
Inserting the Battery Pack and Your Memory Card .....	19
Removing the Battery Pack and Memory Card .....	20
Setting the Date and Time .....	20
Changing the Date and Time.....	21
Display Language.....	22
Trying the Camera Out.....	22
Shooting (Smart Auto).....	22
Viewing .....	24
Erasing Images .....	25

### Advanced Guide

<b>Camera Basics .....</b>	<b>26</b>
On/Off.....	26
Power-Saving Features (Auto Power Down).....	27
Power Saving in Shooting Mode .....	27
Power Saving in Playback Mode .....	27
Shutter Button .....	27
Shooting Modes .....	28
Adjusting the Screen (Monitor) Angle and Orientation .....	28
Tilting the Screen Downward.....	28
Tilting the Screen Upward .....	28
Shooting Display Options .....	29
Using the Quick Set Menu.....	29
Using Touch-Screen Operations to Configure Settings .....	30
Using the Menu Screen.....	30
Touch-Screen Operations.....	31
On-Screen Keyboard.....	32
Indicator Display.....	33
Clock .....	33
<b>Auto Mode / Hybrid Auto Mode.....</b>	<b>34</b>
Shooting with Camera-Determined Settings .....	34
Shooting (Smart Auto) .....	34
Shooting in Hybrid Auto Mode .....	36
Digest Movie Playback .....	37
Still Images/Movies .....	37
Still Images.....	37
Movies .....	38
Scene Icons.....	38
Continuous Shooting Scenes .....	39
Image Stabilization Icons.....	40
On-Screen Frames .....	40

Before Use

Basic Guide

Advanced Guide

Camera Basics

Auto Mode /  
Hybrid Auto Mode

Other Shooting Modes

P Mode

Tv, Av, M, and C Mode

Playback Mode

Wi-Fi Functions

Setting Menu

Accessories

Appendix

Index



Common, Convenient Features .....	41
Zooming In Closer on Subjects (Digital Zoom) .....	41
Shooting at Preset Focal Lengths (Step Zoom) .....	41
Changing the Way the Control of the Camera Feels with the Step/Continuous Selection Lever .....	41
Resizing the Subject with the Control Ring .....	42
Using the Self-Timer .....	42
Using the Self-Timer to Avoid Camera Shake .....	43
Customizing the Self-Timer .....	43
Shooting by Touching the Screen (Touch Shutter) .....	44
Continuous Shooting .....	44
Using Face ID .....	45
Personal Information .....	45
Registering Face ID Information .....	45
Shooting .....	46
Checking and Editing Registered Information .....	47
Overwriting and Adding Face Information .....	48
Erasing Registered Information .....	49
Image Customization Features .....	49
Changing the Aspect Ratio .....	49
Changing Image Quality .....	50
Changing Movie Image Quality .....	50
For NTSC Video .....	50
For PAL Video .....	51
Helpful Shooting Features .....	51
Using the Dual Axis Electronic Level .....	51
Deactivating Auto Level .....	52
Changing the IS Mode Settings .....	52
Deactivating Image Stabilization .....	52
Recording Movies with Subjects at the Same Size Shown before Shooting .....	53
Customizing Camera Operation .....	53

Preventing the AF-Assist Beam from Firing .....	53
Preventing the Red-Eye Reduction Lamp from Lighting Up .....	54
Changing the Image Display Style after Shots .....	54
<b>Other Shooting Modes .....</b>	<b>55</b>
Specific Scenes .....	55
Using Functions for Underwater Shots .....	57
Shooting with an Underwater Focus Range .....	57
Correcting White Balance .....	57
Applying Special Effects .....	58
Shooting Yourself under Optimal Settings (Self Portrait) .....	58
Shooting Images with the Background Blurred to Convey a Sense of Speed (Panning) .....	59
Shooting High-Contrast Scenes (High Dynamic Range) .....	60
Adding Artistic Effects .....	60
Shooting with a Fish-Eye Lens Effect (Fish-Eye Effect) .....	60
Shots Resembling Oil Paintings (Art Bold Effect) .....	61
Shots Resembling Watercolors (Water Painting Effect) .....	61
Shots Resembling Miniature Models (Miniature Effect) .....	62
Playback Speed and Estimated Playback Time (for One-Minute Clips) .....	62
Shooting with a Toy Camera Effect (Toy Camera Effect) .....	63
Making Subjects Stand Out (Background Defocus) .....	63
Shooting with a Soft Focus Effect .....	64
Shooting in Monochrome (Grainy B/W) .....	64
Special Modes for Other Purposes .....	65
Shooting Starry Skies (Star) .....	65
Shooting People against Starry Skies (Star Portrait) .....	65
Shooting Night Scenes under Starry Skies (Star Nightscape) .....	66
Shooting Star Trails (Star Trails) .....	67
Shooting Movies of Star Movement (Star Time-Lapse Movie) .....	68

Before Use

Basic Guide

Advanced Guide

Camera Basics

Auto Mode /  
Hybrid Auto Mode

Other Shooting Modes

P Mode

Tv, Av, M, and C Mode

Playback Mode

Wi-Fi Functions

Setting Menu

Accessories

Appendix

Index



Adjusting Colors .....	70
Adjusting the Focus .....	71
Recording Various Movies .....	72
Recording Movies in [P] Mode .....	72
Locking or Changing Image Brightness before recording .....	72
Disabling Auto Slow Shutter .....	73
Correcting Severe Camera Shake .....	73
Sound Settings .....	73
Deactivating the Wind Filter .....	73
Using the Attenuator .....	74
Recording Short Clips .....	74
Playback Effects .....	74
Shooting Time-Lapse Movies (Time-Lapse Movie) .....	74
Recording iFrame Movies .....	76
<b>P Mode .....</b>	<b>77</b>
Shooting in Program AE ([P] Mode) .....	77
Image Brightness (Exposure) .....	78
Adjusting Image Brightness (Exposure Compensation) .....	78
Deactivating Expo. Simulation .....	78
Locking Image Brightness / Exposure (AE Lock) .....	78
Changing the Metering Method .....	79
Linking the Spot AE Point Frame to the AF Frame .....	79
Changing the ISO Speed .....	80
Adjusting ISO Auto Settings .....	80
Changing the Noise Reduction Level (High ISO Speed NR) .....	80
Auto Exposure Bracketing (AEB Shooting) .....	81
Adjusting Auto ND Filter Settings .....	81
Auto Correction of Brightness and Contrast (Auto Lighting Optimizer) .....	81
Shooting Bright Subjects (Highlight Tone Priority) .....	82
Image Colors .....	82
Capturing Natural Colors (White Balance) .....	82

Custom White Balance .....	83
Manually Correcting White Balance .....	83
Configuring White Balance Color Temperature .....	84
Customizing Colors (Picture Style) .....	84
Customizing Picture Styles .....	85
Registering Customized Picture Styles .....	86
Shooting Range and Focusing .....	87
Shooting Close-Ups (Macro) .....	87
Shooting in Manual Focus Mode .....	87
Easily Identifying the Focus Area (MF Peaking) .....	88
Focus Bracketing (Focus-BKT Mode) .....	88
Digital Tele-Converter .....	89
Choosing the AF Method .....	89
1-point AF .....	90
Moving and Resizing AF Frames (1-point AF) .....	90
AF+Tracking .....	91
Shooting with Servo AF .....	91
Changing the Focus Setting .....	92
Fine-Tuning the Focus .....	92
Choosing a Person to Focus On (Face Select) .....	93
Choosing Subjects to Focus On (Touch AF) .....	93
Shooting with the AF Lock .....	94
Flash .....	95
Changing the Flash Mode .....	95
Auto .....	95
On .....	95
Slow Synchro .....	95
Off .....	95
Adjusting the Flash Exposure Compensation .....	96
Shooting with the FE Lock .....	96
Changing the Flash Timing .....	97
Other Settings .....	97

## Before Use

### Basic Guide

### Advanced Guide

#### Camera Basics

#### Auto Mode / Hybrid Auto Mode

#### Other Shooting Modes

#### P Mode

#### Tv, Av, M, and C Mode

#### Playback Mode

#### Wi-Fi Functions

#### Setting Menu

#### Accessories

#### Appendix

## Index



Changing Image Quality .....	97
Capturing in RAW Format .....	98
Using the Menu .....	98
Changing the IS Mode Settings.....	99
<b>Tv, Av, M, and C Mode.....</b>	<b>100</b>
Specific Shutter Speeds ([Tv] Mode).....	100
Specific Aperture Values ([Av] Mode).....	101
Specific Shutter Speeds and Aperture Values ([M] Mode) ...	101
Shooting Long Exposures (Bulb).....	102
Adjusting the Flash Output .....	103
Recording Movies at Specific Shutter Speeds and Aperture Values.....	103
Customization for Shooting Styles .....	104
Changing Control Ring Settings .....	104
Functions Assignable to the Control Ring .....	105
Assigning Functions to the Control Ring .....	105
Customizing Display Information .....	106
Customizing the Information Displayed .....	106
Assigning Functions to Buttons .....	106
Customizing the Quick Set Menu.....	107
Choosing Items to Include in the Menu .....	107
Rearranging Menu Items .....	108
Saving Shooting Settings .....	108
Settings That Can Be Saved .....	108
Saving Commonly Used Shooting Menu Items (My Menu).....	109
<b>Playback Mode .....</b>	<b>110</b>
Viewing.....	110
Touch-Screen Operations.....	111
Switching Display Modes.....	112
Customizing the Shooting Information Displayed.....	112

Overexposure Warning (for Image Highlights) .....	112
Histogram .....	113
RGB Histogram, GPS Information Display .....	113
Viewing Short Movies Created When Shooting Still Images (Digest Movies).....	114
Viewing by Date.....	114
Checking People Detected in Face ID.....	114
Browsing and Filtering Images .....	115
Navigating through Images in an Index.....	115
Touch-Screen Operations.....	115
Finding Images Matching Specified Conditions.....	115
Using the Control Ring to Jump between Images .....	117
Touch-Screen Operations.....	117
Viewing Individual Images in a Group .....	117
Editing Face ID Information.....	118
Changing Names.....	118
Erasing Names .....	119
Image Viewing Options .....	119
Magnifying Images .....	119
Touch-Screen Operations.....	120
Viewing Slideshows.....	120
Protecting Images .....	121
Using the Menu .....	121
Choosing Images Individually.....	121
Selecting a Range .....	122
Protecting All Images at Once .....	122
Clearing All Protection at Once .....	123
Erasing Images .....	123
Erasing Multiple Images at Once.....	124
Choosing a Selection Method .....	124
Choosing Images Individually.....	124
Selecting a Range .....	125

Before Use

Basic Guide

Advanced Guide

Camera Basics

Auto Mode / Hybrid Auto Mode

Other Shooting Modes

P Mode

Tv, Av, M, and C Mode

Playback Mode

Wi-Fi Functions

Setting Menu

Accessories

Appendix

Index



Specifying All Images at Once.....	125
Rotating Images .....	125
Using the Menu .....	125
Deactivating Auto Rotation .....	126
Tagging Images as Favorites .....	126
Using the Menu .....	126
Convenient Control: Touch Actions .....	127
Using Touch Actions Functions.....	127
Changing Touch Actions Functions .....	127
Assignable Functions .....	128
Editing Still Images.....	128
Resizing Images.....	128
Using the Menu .....	129
Cropping .....	129
Applying Filter Effects.....	130
Correcting Red-Eye.....	131
Processing RAW Images on the Camera.....	132
Using the Menu .....	133
Choosing Images Individually.....	133
Selecting a Range .....	133
Editing Movies.....	134
Reducing File Sizes.....	135
Image Quality of Compressed Movies .....	135
Editing Short Movies.....	135
Viewing Albums (Story Highlights) .....	136
Choosing Themes for Albums .....	136
Adding Background Music to Albums .....	137
Creating Your Own Albums.....	138
Combining Short Clips.....	139
<b>Wi-Fi Functions .....</b>	<b>141</b>
Available Wi-Fi Features .....	141

Sending Images to a Smartphone.....	142
Sending Images to an NFC-Compatible Smartphone .....	142
Connecting via NFC When Camera Is Off or in Shooting Mode .....	142
Connecting via NFC When Camera Is in Playback Mode...	144
Adding a Smartphone.....	144
Using Another Access Point .....	146
Previous Access Points .....	147
Saving Images to a Computer.....	147
Preparing to Register a Computer.....	147
Installing the Software .....	147
Configure the computer for a Wi-Fi connection (Windows only).....	148
Saving Images to a Connected Computer.....	149
Confirming Access Point Compatibility.....	149
Using WPS-Compatible Access Points .....	149
Connecting to Listed Access Points .....	151
Previous Access Points .....	152
Sending Images to a Registered Web Service.....	153
Registering Web Services .....	153
Registering CANON iIMAGE GATEWAY.....	153
Registering Other Web Services .....	155
Uploading Images to Web Services .....	156
Printing Images Wirelessly from a Connected Printer.....	157
Sending Images to Another Camera .....	158
Image Sending Options.....	159
Sending Multiple Images .....	159
Choosing Images Individually.....	159
Selecting a Range .....	160
Sending Favorite Images .....	160
Notes on Sending Images .....	161
Choosing the Number of Recording Pixels (Image Size) .....	161

Before Use

Basic Guide

Advanced Guide

Camera Basics

Auto Mode / Hybrid Auto Mode

Other Shooting Modes

P Mode

Tv, Av, M, and C Mode

Playback Mode

Wi-Fi Functions

Setting Menu

Accessories

Appendix

Index



Adding Comments .....	161
Sending Images Automatically (Image Sync).....	162
Initial Preparations .....	162
Preparing the Camera .....	162
Preparing the Computer .....	162
Sending Images.....	163
Viewing Images Sent via Image Sync on a Smartphone .....	163
Using a Smartphone to View Camera Images and Control the Camera.....	164
Geotagging Images on the Camera .....	164
Shooting Remotely .....	164
Editing or Erasing Wi-Fi Settings.....	165
Editing Connection Information .....	165
Changing a Device Nickname .....	166
Erasing Connection Information .....	166
Changing the Camera Nickname .....	166
Returning the Wi-Fi Settings to Default .....	167
<b>Setting Menu.....</b>	<b>168</b>
Adjusting Basic Camera Functions .....	168
Date-Based Image Storage .....	168
File Numbering .....	168
Formatting Memory Cards .....	169
Low-Level Formatting .....	169
Changing the Video System .....	170
Electronic Level Calibration .....	170
Resetting the Electronic Level.....	170
Start-Up Screen .....	170
Using Eco Mode .....	171
Power-Saving Adjustment .....	171
Screen Brightness .....	171
Switching the Color of Screen Information .....	172

World Clock .....	172
Date and Time .....	172
Lens Retraction Timing.....	173
Display Language.....	173
Silencing Camera Operations.....	173
Adjusting the Volume.....	173
Customizing Sounds.....	174
Hiding Hints and Tips.....	174
Listing Shooting Modes by Icon.....	174
Adjusting the Touch-Screen Panel .....	174
Metric / Non-Metric Display .....	175
Checking Certification Logos .....	175
Setting Copyright Information to Record in Images.....	175
Deleting All Copyright Information .....	175
Adjusting Other Settings.....	176
Restoring Default Camera Settings .....	176
<b>Accessories .....</b>	<b>177</b>
System Map .....	177
Optional Accessories.....	178
Power Supplies.....	178
Flash.....	178
Other Accessories .....	178
Printers .....	179
Photo and Movie Storage .....	179
Using Optional Accessories.....	179
Playback on a TV .....	179
Inserting and Charging the Battery Pack.....	180
Using a Computer to Charge the Battery .....	181
Using the Software .....	182
Computer Connections via a Cable.....	182
Checking Your Computer Environment .....	182

Before Use

Basic Guide

Advanced Guide

Camera Basics

Auto Mode /  
Hybrid Auto Mode

Other Shooting Modes

P Mode

Tv, Av, M, and C Mode

Playback Mode

Wi-Fi Functions

Setting Menu

Accessories

Appendix

Index



Installing the Software .....	182
Saving Images to a Computer .....	182
Printing Images .....	184
Easy Print .....	184
Configuring Print Settings .....	185
Cropping Images before Printing .....	185
Choosing Paper Size and Layout before Printing .....	186
Available Layout Options .....	186
Printing ID Photos .....	186
Printing Movie Scenes .....	187
Movie Printing Options .....	187
Adding Images to the Print List (DPOF) .....	187
Configuring Print Settings .....	188
Setting Up Printing for Individual Images .....	188
Setting Up Printing for a Range of Images .....	189
Setting Up Printing for All Images .....	189
Clearing All Images from the Print List .....	189
Printing Images Added to the Print List (DPOF) .....	189
Adding Images to a Photobook .....	190
Choosing a Selection Method .....	190
Adding Images Individually .....	190
Adding All Images to a Photobook .....	190
Removing All Images from a Photobook .....	190
<b>Appendix .....</b>	<b>191</b>
Troubleshooting .....	191
On-Screen Messages .....	195
On-Screen Information .....	197
Shooting (Information Display) .....	197
Battery Level .....	197
Playback (Detailed Information Display) .....	198
Summary of Movie Control Panel .....	199

Functions and Menu Tables .....	200
Functions Available in Each Shooting Mode .....	200
Quick Set Menu .....	203
Shooting Tab .....	206
Set Up Tab .....	215
My Menu Tab .....	215
Playback Tab .....	216
Handling Precautions .....	217
Specifications .....	217
Camera .....	217
Number of Shots/Recording Time, Playback Time .....	219
Shooting Range .....	219
Number of Shots per Memory Card .....	220
Recording Time per Memory Card .....	220
Battery Pack NB-13L .....	221
Battery Charger CB-2LH/CB-2LHE .....	221
Compact Power Adapter CA-DC30/CA-DC30E .....	221
Index .....	222
Wi-Fi (Wireless LAN) Precautions .....	224
Radio Wave Interference Precautions .....	224
Security Precautions .....	224
Trademarks and Licensing .....	225
Disclaimer .....	225

Before Use

Basic Guide

Advanced Guide

Camera Basics

Auto Mode /  
Hybrid Auto Mode

Other Shooting Modes

P Mode

Tv, Av, M, and C Mode

Playback Mode

Wi-Fi Functions

Setting Menu

Accessories

Appendix

Index



# Common Camera Operations

## Shoot

- Use camera-determined settings (Auto Mode, Hybrid Auto Mode)
  - 34, 36
- Shoot yourself under optimal settings (Self Portrait)
  - 58

Shooting people well

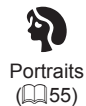

Matching specific scenes



Applying special effects



Fish-Eye Effect  
(60)



Miniature Effect  
(62)



Toy Camera Effect  
(63)



Background Defocus  
(63)



Soft Focus  
(64)



Monochrome  
(64)

- Focus on faces
  - 34, 55, 91, 93
- Without using the flash (Flash Off)
  - 34
- Include yourself in the shot (Self-Timer)
  - 42
- Movie clips and photos together (Movie Digest)
  - 36
- Shoot images with the background blurred to convey a sense of speed
  - 59

Before Use

Basic Guide

Advanced Guide

Camera Basics

Auto Mode / Hybrid Auto Mode

Other Shooting Modes

P Mode

Tv, Av, M, and C Mode

Playback Mode

Wi-Fi Functions

Setting Menu

Accessories







Appendix

Index









## View

- View images (Playback Mode)
  -  110
- Automatic playback (Slideshow)
  -  120
- On a TV
  -  179
- On a computer
  -  182
- Browse through images quickly
  -  115
- Erase images
  -  123
- Create an album automatically
  -  136

## Record/View Movies

- Record movies
  -  34,  72,  103
- View movies (Playback Mode)
  -  110



## Print

- Print pictures
  -  184

## Save

- Save images to a computer
  -  182

## Use Wi-Fi functions

- Send images to a smartphone
  -  142
- Share images online
  -  153
- Send images to a computer
  -  162

## Before Use

### Basic Guide

### Advanced Guide

#### Camera Basics

#### Auto Mode / Hybrid Auto Mode

#### Other Shooting Modes

#### P Mode

#### Tv, Av, M, and C Mode

#### Playback Mode

#### Wi-Fi Functions

#### Setting Menu

#### Accessories

#### Appendix

## Index



## Safety Precautions

- Before using the product, ensure that you read the safety precautions described below. Always ensure that the product is used correctly.
- The safety precautions noted here are intended to prevent you and other persons from being injured or incurring property damage.
- Be sure to also check the guides included with any separately sold accessories you use.

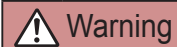

### Warning

Denotes the possibility of serious injury or death.

- Do not trigger the flash in close proximity to people's eyes. This could damage your eyesight. In particular, remain at least 1 meter (3.3 feet) away from infants when using the flash.
- Store this equipment out of the reach of children and infants. A strap wound around a child's neck may result in asphyxiation. If your product uses a power cord, mistakenly winding the cord around a child's neck may result in asphyxiation.
- Use only recommended power sources.
- Do not disassemble, alter, or apply heat to the product.
- Do not peel off the adhesive covering, if the battery pack has it.
- Avoid dropping or subjecting the product to severe impacts.
- Do not touch the interior of the product if it is broken, such as when dropped.
- Stop using the product immediately if it emits smoke or a strange smell, or otherwise behaves abnormally.
- Do not use organic solvents such as alcohol, benzene, or thinner to clean the product.

- Avoid contact with liquid, and do not allow liquid or foreign objects inside.

This could result in electrical shock or fire.

If the product gets wet, or if liquid or foreign objects get inside, remove the battery pack/batteries or unplug immediately.

- If your model has a viewfinder or interchangeable lens, do not look through the viewfinder or lens at bright light sources (such as the sun on a clear day, or a bright artificial light source).

This may damage your eyesight.

- If your model has an interchangeable lens, do not leave the lens (or the camera with the lens attached) in the sun without the lens cap on. This could result in a fire.

- Do not touch the product during thunderstorms if it is plugged in. This could result in electrical shock or fire. Immediately stop using the product and distance yourself from it.

- Use only the recommended battery pack/batteries.

- Do not place the battery pack/batteries near or in direct flame. This may cause the battery pack/batteries to explode or leak, resulting in electrical shock, fire, or injuries. If leaking battery electrolyte comes into contact with eyes, mouth, skin, or clothing, immediately flush with water.

- If the product uses a battery charger, note the following precautions.

- Remove the plug periodically and, using a dry cloth, wipe away any dust and dirt that has collected on the plug, the exterior of the power outlet, and the surrounding area.
- Do not insert or remove the plug with wet hands.
- Do not use the equipment in a manner that exceeds the rated capacity of the electrical outlet or wiring accessories. Do not use if the plug is damaged or not fully inserted in the outlet.
- Do not allow dust or metal objects (such as pins or keys) to contact the terminals or plug.
- Do not cut, damage, alter, or place heavy items on the power cord, if your product uses one.

This could result in electrical shock or fire.

Before Use

Basic Guide

Advanced Guide

Camera Basics

Auto Mode /  
Hybrid Auto Mode

Other Shooting Modes

P Mode

Tv, Av, M, and C Mode

Playback Mode

Wi-Fi Functions

Setting Menu

Accessories

Appendix

Index



- Turn the camera off in places where camera use is prohibited. The electromagnetic waves emitted by the camera may interfere with the operation of electronic instruments and other devices. Exercise adequate caution when using the product in places where use of electronic devices is restricted, such as inside airplanes and medical facilities.

- Do not allow the camera to maintain contact with skin for extended periods.

Even if the camera does not feel hot, this may cause low-temperature burns, manifested in redness of the skin or blistering. Use a tripod in hot places, or if you have poor circulation or insensitive skin.

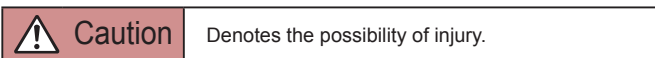

Denotes the possibility of injury.

- When carrying the product by the strap, be careful not to bang it, subject it to strong impacts or shocks, or let it get caught on other objects.

- Be careful not to bump or push strongly on the lens. This could lead to injury or damage the camera.

- Be careful not to subject the screen to strong impacts. If the screen cracks, injury may result from the broken fragments.

- When using the flash, be careful not to cover it with your fingers or clothing.

This could result in burns or damage to the flash.

- Avoid using, placing, or storing the product in the following places:
  - Places subject to direct sunlight
  - Places subject to temperatures above 40 °C (104 °F)
  - Humid or dusty places

These could cause leakage, overheating, or an explosion of the battery pack/batteries, resulting in electrical shock, fire, burns, or other injuries. Overheating and damage may result in electrical shock, fire, burns, or other injuries.

- The slideshow transition effects may cause discomfort when viewed for prolonged periods.

- When using optional lenses, lens filters, or filter adapters (if applicable), be sure to attach these accessories firmly.

If the lens accessory becomes loose and falls off, it may crack, and the shards of glass may lead to cuts.

- On products that raise and lower the flash automatically, make sure to avoid pinching your fingers with the lowering flash.

This could result in injury.

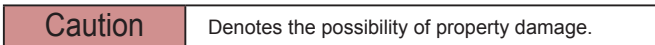

Denotes the possibility of property damage.

- Do not aim the camera at intense light sources, such as the sun on a clear day or an intense artificial light source.

Doing so may damage the image sensor or other internal components.

- When using the camera on a sandy beach or at a windy location, be careful not to allow dust or sand to enter the camera.

- On products that raise and lower the flash automatically, do not push the flash down or pry it open.

This may cause the product to malfunction.

- Wipe off any dust, grime, or other foreign matter on the flash with a cotton swab or cloth.

The heat emitted from the flash may cause foreign matter to smoke or the product to malfunction.

- Remove and store the battery pack/batteries when you are not using the product.

Any battery leakage that occurs may cause product damage.

- Before you discard the battery pack/batteries, cover the terminals with tape or other insulators.

Contacting other metal materials may lead to fire or explosions.

- Unplug any battery charger used with the product when not in use. Do not cover with a cloth or other objects when in use.

Leaving the unit plugged in for a long period of time may cause it to overheat and distort, resulting in fire.



- Do not leave any dedicated battery packs near pets. Pets biting the battery pack could cause leakage, overheating, or explosion, resulting in product damage or fire.

- If your product uses multiple batteries, do not use batteries that have different levels of charge together, and do not use old and new batteries together. Do not insert the batteries with the + and – terminals reversed.

This may cause the product to malfunction.

- When putting the camera in your bag, ensure that hard objects do not come into contact with the screen. Also close the screen (so that it faces the body), if your product's screen closes.

- Do not attach any hard objects to the product. Doing so may cause malfunctions or damage the screen.



# Basic Guide

## Basic Operations

Basic information and instructions, from initial preparations to shooting and playback

### Touch-Screen Operations

The camera's touch-screen panel enables intuitive operation simply by touching or tapping the screen.

#### Touching

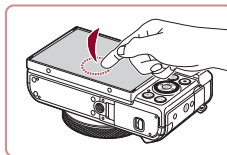

**Touch the screen briefly with your finger.**

- This gesture is used to shoot, configure camera functions, and so on.

#### Dragging

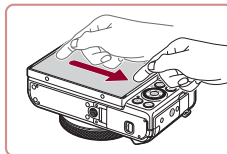

**Touch the screen and move your finger across it.**

- This gesture is used in Playback mode to switch to the next image, or to change the magnified image area, among other operations.

Before Use

**Basic Guide**

Advanced Guide

Camera Basics

Auto Mode /  
Hybrid Auto Mode

Other Shooting Modes

P Mode

Tv, Av, M, and C Mode

Playback Mode

Wi-Fi Functions

Setting Menu

Accessories

Appendix

Index



## Initial Preparations

Prepare for shooting as follows.

### Attaching the Strap

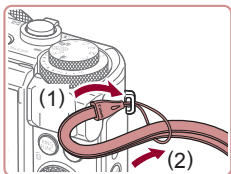

#### Attach the strap.

- Thread the end of the strap through the strap mount (1), and then pull the other end of the strap through the loop on the threaded end (2).

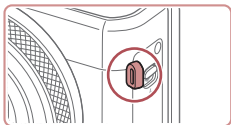

- The strap can also be attached to the left side of the camera.

### Holding the Camera



- Place the strap around your wrist.
- When shooting, keep your arms close to your body and hold the camera securely to prevent it from moving. If you have raised the flash, do not rest your fingers on it.

## Charging the Battery Pack

Before use, charge the battery pack with the included charger. Be sure to charge the battery pack initially, because the camera is not sold with the battery pack charged.

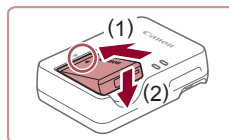

### 1 Insert the battery pack.

- After aligning the ▲ marks on the battery pack and charger, insert the battery pack by pushing it in (1) and down (2).

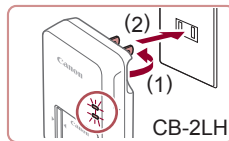

### 2 Charge the battery pack.

- **CB-2LH:** Flip out the plug (1) and plug the charger into a power outlet (2).
- **CB-2LHE:** Plug the power cord into the charger, then plug the other end into a power outlet.
- The charging lamp turns orange, and charging begins.
- When charging is finished, the lamp turns green.

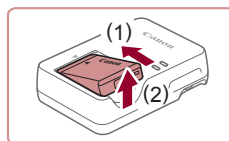
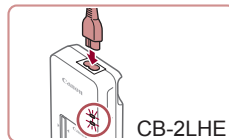

### 3 Remove the battery pack.

- After unplugging the battery charger, remove the battery pack by pushing it in (1) and up (2).



- To protect the battery pack and keep it in optimal condition, do not charge it continuously for more than 24 hours.
- For battery chargers that use a power cord, do not attach the charger or cord to other objects. Doing so could result in malfunction or damage to the product.

Before Use

Basic Guide

Advanced Guide

Camera Basics

Auto Mode /  
Hybrid Auto Mode

Other Shooting Modes

P Mode

Tv, Av, M, and C Mode

Playback Mode

Wi-Fi Functions

Setting Menu

Accessories

Appendix

Index





- For details on charging time and the number of shots and recording time possible with a fully charged battery pack, see “Number of Shots/Recording Time, Playback Time” (169).
- Charged battery packs gradually lose their charge, even when they are not used. Charge the battery pack on (or immediately before) the day of use.
- As a visual reminder of the charge status, attach the battery cover with ▲ visible on a charged battery pack and concealed on an uncharged one.
- The charger can be used in areas with 100 – 240 V AC power (50/60 Hz). For power outlets in a different format, use a commercially available adapter for the plug. Never use an electrical transformer designed for traveling, which may damage the battery pack.

## Inserting the Battery Pack and Your Memory Card

Insert the included battery pack and a memory card (sold separately). Note that before using a memory card that is new or has been formatted in another device, you should format the memory card with this camera (169).

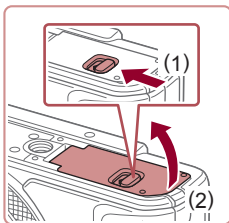

### 1 Open the cover.

- Slide the switch (1) and open the cover (2).

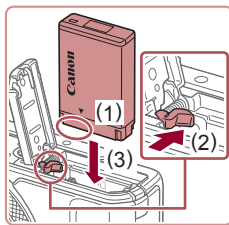

### 2 Insert the battery pack.

- Holding the battery pack with the terminals in the position shown (1), hold the battery lock toward (2) and insert the battery pack toward (3) until the lock clicks shut.
- If you insert the battery pack facing the wrong way, it cannot be locked into the correct position. Always confirm that the battery pack is facing the right way and locks when inserted.

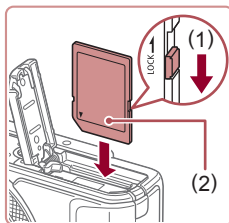

### 3 Check your card's write-protect switch and insert the memory card.

- Recording is not possible on memory cards with a write-protect switch when the switch is in the locked position. Move the switch toward (1).
- Insert the memory card with the label (2) facing as shown until it clicks into place.
- Make sure the memory card is facing the right way when you insert it. Inserting memory cards facing the wrong way may damage the camera.

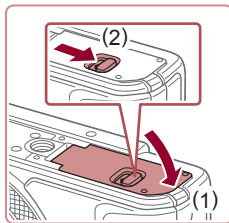

### 4 Close the cover.

- Lower the cover (1) and hold it down as you slide the switch, until it clicks into the closed position (2).

Before Use

Basic Guide

Advanced Guide

Camera Basics

Auto Mode /  
Hybrid Auto Mode

Other Shooting Modes

P Mode

Tv, Av, M, and C Mode

Playback Mode

Wi-Fi Functions

Setting Menu

Accessories

Appendix

Index





- For guidelines on how many shots or hours of recording can be saved on one memory card, see “Number of Shots per Memory Card” (p.220).

## Removing the Battery Pack and Memory Card

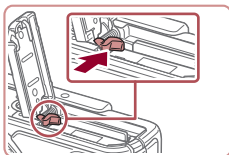

### Remove the battery pack.

- Open the cover and press the battery lock in the direction of the arrow.
- The battery pack will pop up.

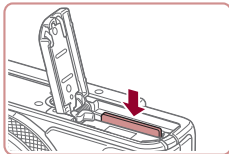

### Remove the memory card.

- Push the memory card in until it clicks, and then slowly release it.
- The memory card will pop up.

## Setting the Date and Time

Set the current date and time correctly as follows if the [Date/Time] screen is displayed when you turn the camera on. Information you specify this way is recorded in image properties when you shoot, and it is used when you manage images by shooting date or print images showing the date.

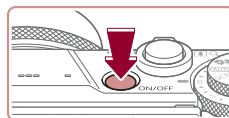

### 1 Turn the camera on.

- Press the power button.
- The [Date/Time] screen is displayed.

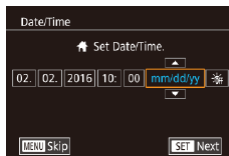

### 2 Set the date and time.

- Press the [◀][▶] buttons to choose an item.
- Press the [▲][▼] buttons or turn the [DISP] dial to specify the date and time.
- When finished, press the [SET] button.

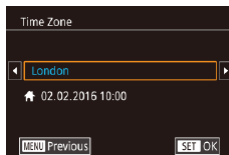

### 3 Specify your home time zone.

- Press the [◀][▶] buttons to choose your home time zone.

### 4 Finish the setup process.

- Press the [SET] button when finished. After a confirmation message, the setting screen is no longer displayed.
- To turn off the camera, press the power button.



Before Use

Basic Guide

Advanced Guide

Camera Basics

Auto Mode /  
Hybrid Auto Mode

Other Shooting Modes

P Mode

Tv, Av, M, and C Mode

Playback Mode

Wi-Fi Functions

Setting Menu

Accessories

Appendix

Index







- Unless you set the date, time, and home time zone, the [Date/Time] screen will be displayed each time you turn the camera on. Specify the correct information.



- To set daylight saving time (1 hour ahead), choose [OFF] in step 2 and then choose [ON] by pressing the [▲][▼] buttons or turning the [DIAL] dial.



- You can also set the date and time by touching the desired item on the screen in step 2 and then touching [▲][▼], followed by [SET]. Similarly, you can also set your home time zone by touching [◀][▶] on the screen in step 3, followed by [SET].

## Changing the Date and Time

Adjust the date and time as follows.

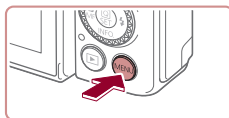

### 1 Access the menu screen.

- Press the [MENU] button.

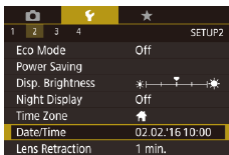

### 2 Choose [Date/Time].

- Press the [◀][▶] buttons to choose the [2] tab.
- Press the [▲][▼] buttons or turn the [DIAL] dial to choose [Date/Time], and then press the [DIAL] button.



### 3 Change the date and time.

- Follow step 2 in “Setting the Date and Time” (20) to adjust the settings.
- Press the [MENU] button to close the menu screen.



- The camera has a built-in date/time battery (backup battery). Date/time settings can be retained for about 3 weeks after the battery pack is removed.
- The date/time battery will be charged in about 4 hours once you insert a charged battery pack, even if power to the camera is turned off.
- Once the date/time battery is depleted, the [Date/Time] screen will be displayed when you turn the camera on. Set the correct date and time as described in “Setting the Date and Time” (20).

Before Use

Basic Guide

Advanced Guide

Camera Basics

Auto Mode /  
Hybrid Auto Mode

Other Shooting Modes

P Mode

Tv, Av, M, and C Mode

Playback Mode

Wi-Fi Functions

Setting Menu

Accessories

Appendix

Index



## Display Language

Change the display language as needed.



### 1 Enter Playback mode.

- Press the [▶] button.

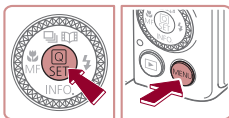

### 2 Access the setting screen.

- Press and hold the [SET] button, and then immediately press the [MENU] button.



### 3 Set the display language.

- Press the [▲][▼][◀][▶] buttons or turn the [DIAL] dial to choose a language, and then press the [SET] button.
- Once the display language has been set, the setting screen is no longer displayed.



- The current time is displayed if you wait too long in step 2 after pressing the [SET] button before you press the [MENU] button. In this case, press the [SET] button to dismiss the time display and repeat step 2.
- You can also change the display language by pressing the [MENU] button and choosing [Language] on the [4] tab.



- You can also set the display language by touching a language on the screen in step 3 and then touching it again.

## Trying the Camera Out

▶ Still Images ▶ Movies

Follow these instructions to turn the camera on, shoot still images or movies, and then view them.

## Shooting (Smart Auto)

For fully automatic selection of the optimal settings for specific scenes, simply let the camera determine the subject and shooting conditions.

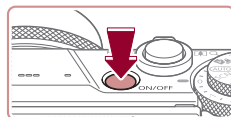

### 1 Turn the camera on.

- Press the power button.
- The startup screen is displayed.

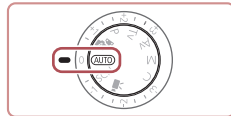

### 2 Enter [AUTO] mode.

- Set the mode dial to [AUTO].
- Aim the camera at the subject. The camera will make a slight clicking noise as it determines the scene.
- Icons representing the scene and image stabilization mode are displayed in the upper left of the screen.
- Frames displayed around any detected subjects indicate that they are in focus.

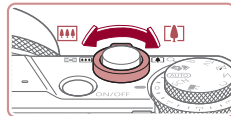

### 3 Compose the shot.

- To zoom in and enlarge the subject, move the zoom lever toward [T] (telephoto), and to zoom away from the subject, move it toward [W] (wide angle).

Before Use

Basic Guide

Advanced Guide

Camera Basics

Auto Mode / Hybrid Auto Mode

Other Shooting Modes

P Mode

Tv, Av, M, and C Mode

Playback Mode

Wi-Fi Functions

Setting Menu

Accessories

Appendix

Index



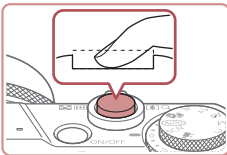
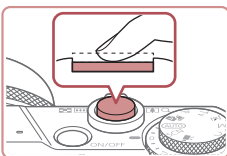

## 4 Shoot.

### Shooting Still Images

#### 1) Focus.

- Press the shutter button lightly, halfway down. The camera beeps twice after focusing, and frames are displayed to indicate image areas in focus.

- If [Raise the flash] is displayed, move the  switch to raise the flash. It will fire when shooting. If you prefer not to use the flash, push it down with your finger, into the camera.

#### 2) Shoot.

- Press the shutter button all the way down.
- As the camera shoots, a shutter sound is played, and in low-light conditions when you have raised the flash, it fires automatically.
- Keep the camera still until the shutter sound ends.
- After displaying your shot, the camera will revert to the shooting screen.

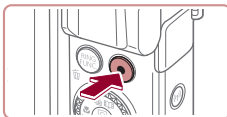

(1)

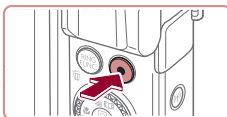

## Recording Movies

### 1) Start recording.

- Press the movie button. The camera beeps once as recording begins, and [●Rec] is displayed with the elapsed time (1).

- Black bars are displayed on the top and bottom edges of the screen, and the subject is slightly enlarged. The black bars indicate image areas not recorded.
- Frames displayed around any detected faces indicate that they are in focus.
- Once recording begins, take your finger off the movie button.

### 2) Finish recording.

- Press the movie button again to stop recording. The camera beeps twice as recording stops.

Before Use

Basic Guide

Advanced Guide

Camera Basics

Auto Mode /  
Hybrid Auto Mode

Other Shooting Modes

P Mode

Tv, Av, M, and C Mode

Playback Mode

Wi-Fi Functions

Setting Menu

Accessories

Appendix

Index



## Viewing

After shooting images or movies, you can view them on the screen as follows.



### 1 Enter Playback mode.

- Press the [▶] button.
- Your last shot is displayed.



### 2 Choose images.

- To view the previous image, press the [◀] button or turn the [●] dial counterclockwise. To view the next image, press the [▶] button or turn the [●] dial clockwise.
- Press and hold the [◀][▶] buttons to browse through images quickly.

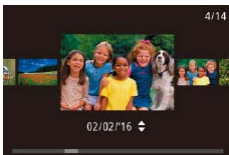

- To access this screen (Scroll Display mode), turn the [●] dial rapidly. In this mode, turn the [●] dial to browse through images.
- To return to single-image display, press the [SET] button.
- Movies are identified by a [SET ▶] icon. To play movies, go to step 3.

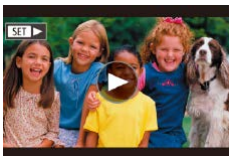

### 3 Play movies.

- Press the [SET] button, press the [▲][▼] buttons to choose [▶], and then press the [SET] button again.
- Playback now begins, and after the movie is finished, [SET ▶] is displayed.
- To adjust the volume, press the [▲][▼] buttons during playback.



- To switch to Shooting mode from Playback mode, press the shutter button halfway.



- You can also start movie playback by touching [▶]. To adjust the volume, quickly drag up or down across the screen during playback.

Before Use

Basic Guide

Advanced Guide

Camera Basics

Auto Mode /  
Hybrid Auto Mode

Other Shooting Modes

P Mode

Tv, Av, M, and C Mode

Playback Mode

Wi-Fi Functions

Setting Menu

Accessories

Appendix

Index



## Erasing Images

You can choose and erase unneeded images one by one. Erased images cannot be recovered. Be sure that you want to erase the image before using this option.



### 1 Choose an image to erase.

- Press the [◀][▶] buttons or turn the [DISP] dial to choose an image.

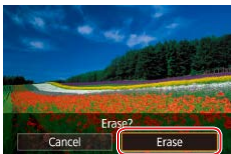

### 2 Erase the image.

- Press the [Erase] button.
- After [Erase?] is displayed, press the [◀][▶] buttons or turn the [DISP] dial to choose [Erase], and then press the [DISP] button.
- The current image is now erased.
- To cancel erasure, press the [◀][▶] buttons or turn the [DISP] dial to choose [Cancel], and then press the [DISP] button.



- You can choose multiple images to erase at once (📖124).



- You can also erase the current image by touching [Erase] on the screen in step 2.
- Images can also be erased by using Touch Actions (📖127).

Before Use

Basic Guide

Advanced Guide

Camera Basics

Auto Mode /  
Hybrid Auto Mode

Other Shooting Modes

P Mode

Tv, Av, M, and C Mode

Playback Mode

Wi-Fi Functions

Setting Menu

Accessories

Appendix

Index



# Advanced Guide

## Camera Basics

Other basic operations and more ways to enjoy your camera, including shooting and playback options

### On/Off

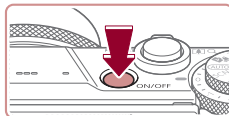

#### Shooting Mode

- Press the power button to turn the camera on and prepare for shooting.
- To turn the camera off, press the power button again.

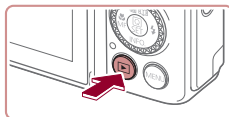

#### Playback Mode

- Press the [▶] button to turn the camera on and view your shots.
- To turn the camera off, press the [▶] button again.



- To switch to Playback mode from Shooting mode, press the [▶] button.
- The lens will be retracted after about one minute once the camera is in Playback mode. You can turn the camera off when the lens is retracted by pressing the [▶] button.

Before Use

Basic Guide

Advanced Guide

Camera Basics

Auto Mode /  
Hybrid Auto Mode

Other Shooting Modes

P Mode

Tv, Av, M, and C Mode

Playback Mode

Wi-Fi Functions

Setting Menu

Accessories

Appendix

Index



## Power-Saving Features (Auto Power Down)

As a way to conserve battery power, the camera automatically deactivates the screen (Display Off) and then turns itself off after a specific period of inactivity.

### Power Saving in Shooting Mode

The screen is automatically deactivated after about one minute of inactivity. In about two more minutes, the lens is retracted and the camera turns itself off. To activate the screen and prepare for shooting when the screen is off but the lens is still out, press the shutter button halfway (📖27).

### Power Saving in Playback Mode

The camera turns itself off automatically after about five minutes of inactivity.



- You can deactivate Auto Power Down and adjust the timing of Display Off, if you prefer (📖171).
- Power saving is not active while the camera is connected to other devices via Wi-Fi (📖141), or when connected to a computer (📖182).

## Shutter Button

To ensure your shots are in focus, always begin by holding the shutter button halfway down, and once the subject is in focus, press the button all the way down to shoot.

In this manual, shutter button operations are described as pressing the button *halfway* or *all the way down*.

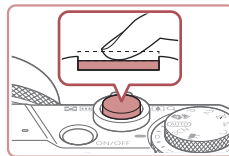

### 1 Press halfway. (Press lightly to focus.)

- Press the shutter button halfway. The camera beeps twice, and frames are displayed around image areas in focus.

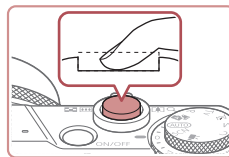

### 2 Press all the way down. (From the halfway position, press fully to shoot.)

- The camera shoots, as a shutter sound is played.
- Keep the camera still until the shutter sound ends.



- Images may be out of focus if you shoot without initially pressing the shutter button halfway.
- Length of shutter sound playback varies depending on the time required for the shot. It may take longer in some shooting scenes, and images will be blurry if you move the camera (or the subject moves) before the shutter sound ends.

Before Use

Basic Guide

Advanced Guide

Camera Basics

Auto Mode /  
Hybrid Auto Mode

Other Shooting Modes

P Mode

Tv, Av, M, and C Mode

Playback Mode

Wi-Fi Functions

Setting Menu

Accessories

Appendix

Index



## Shooting Modes

Use the mode dial to access each shooting mode.

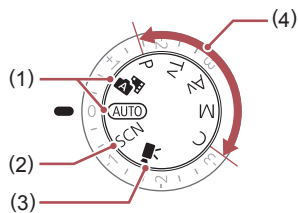

- (1) **Auto Mode / Hybrid Auto Mode**  
Fully automatic shooting, with camera-determined settings (📖22, 📖34, 📖36).
- (2) **Special Scene Mode**  
Shoot with settings designed for specific scenes, or add a variety of effects (📖55).
- (3) **Movie Mode**  
For shooting movies (📖72, 📖103).  
You can also shoot movies when the mode dial is not set to Movie mode, simply by pressing the movie button.
- (4) **P, Tv, Av, M, and C Modes**  
Take a variety of shots using your preferred settings (📖77, 📖100).

## Adjusting the Screen (Monitor) Angle and Orientation

You can adjust the screen angle and orientation to suit the scene or how you are shooting.

### Tilting the Screen Downward

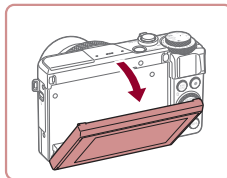

- Pull the top of the screen down toward you.
- The screen can be tilted downward approximately 45°.

### Tilting the Screen Upward

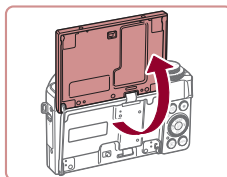

- The screen can be tilted upward approximately 180°.
- When including yourself in shots, you can view a mirror image of yourself by rotating the screen around toward the front of the camera.
- When finished, rotate the screen until it clicks into place to close it.



- When the camera is not in use, keep the screen closed.
- Do not force the screen open too far, which may damage the camera.



- To cancel reverse display, press the **[MENU]** button, choose [Reverse Display] on the **[1]** tab, and then choose [Off].

Before Use

Basic Guide

Advanced Guide

Camera Basics

Auto Mode /  
Hybrid Auto Mode

Other Shooting Modes

P Mode

Tv, Av, M, and C Mode

Playback Mode

Wi-Fi Functions

Setting Menu

Accessories

Appendix

Index





## Shooting Display Options

Press the [▼] button to show or hide the grid lines and electronic level. To configure the on-screen display in greater detail, access [📷1] tab ▶ [Shooting information display] (📖106).



- Screen brightness is automatically increased by the night view function when you are shooting under low light, making it easier to check how shots are composed. However, on-screen image brightness may not match the brightness of your shots. Note that any on-screen image distortion or jerky subject motion will not affect recorded images.
- For playback display options, see “Switching Display Modes” (📖112).

## Using the Quick Set Menu

Configure commonly used functions in the [Q] (Quick Set) menu. Note that menu items and options vary depending on the shooting mode (📖203).

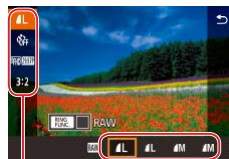

(1)

(2)



### 1 Access the Q menu.

- Press the [Q] button.

### 2 Choose a menu item.

- Press the [▲][▼] buttons to choose a menu item (1).
- Available options (2) are shown at the bottom of the screen.

### 3 Choose an option.

- Press the [◀][▶] buttons or turn the [DIAL] dial to choose an option.
- Items labeled with a [MENU] icon can be configured by pressing the [MENU] button.
- Items labeled with a [FUNC.] icon can be configured by pressing the [FUNC.] button.
- Items labeled with a [INFO.] icon can be configured by pressing the [▼] button.

Before Use

Basic Guide

Advanced Guide

Camera Basics

Auto Mode /  
Hybrid Auto Mode

Other Shooting Modes

P Mode

Tv, Av, M, and C Mode

Playback Mode

Wi-Fi Functions

Setting Menu

Accessories

Appendix

Index





#### 4 Confirm your choice and exit.

- Press the [SET] button.
- The screen before you pressed the [SET] button in step 1 is displayed again, showing the option you configured.



- To undo any accidental setting changes, you can restore the camera's default settings (176).
- You can also exit by choosing [ ] in the menu items and pressing the [SET] button.

## Using Touch-Screen Operations to Configure Settings



- Touch [Q] in the upper right of the screen to access the Quick Set menu.
- Touch a menu item and then an option to complete the setting.
- To return to the previous screen, touch the [ ] menu item, or touch the selected option again.
- You can access the screen for items labeled with a [MENU] icon by touching [MENU].
- You can access the screen for items labeled with a [RING FUNC.] icon by touching [RING FUNC.].
- You can access the screen for items labeled with a [INFO.] icon by touching [INFO.].

## Using the Menu Screen

Configure a variety of camera functions through the menu screen as follows.

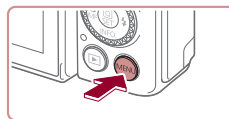

### 1 Access the menu screen.

- Press the [MENU] button.

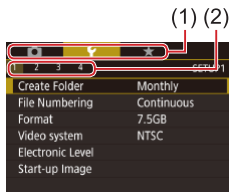

### 2 Choose a tab.

- Tabs represent functions (1), such as shooting ([ ]), playback ([ ]), or settings ([ ]), or pages within each function (2). Tabs are identified in this manual by combining the function and page, as in [ ]1].
- Move the zoom lever to choose the function tab, and then press the [ ] [ ] buttons to choose the page tab.
- You can also drag left or right across the screen to choose the page tab.

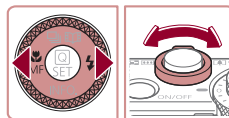

### 3 Choose a menu item.

- Press the [▲][▼] buttons or turn the [ ] dial to choose an item, and then press the [SET] button.
- For menu items with options not shown, first press the [SET] button to switch screens, and then either press the [▲][▼] buttons or turn the [ ] dial to select the menu item.
- To return to the previous screen, press the [MENU] button.

Before Use

Basic Guide

Advanced Guide

Camera Basics

Auto Mode / Hybrid Auto Mode

Other Shooting Modes

P Mode

Tv, Av, M, and C Mode

Playback Mode

Wi-Fi Functions

Setting Menu

Accessories

Appendix

Index



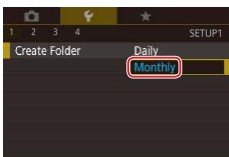

#### 4 Choose an option.

- When options are listed vertically, press the [▲][▼] buttons or turn the [DIAL] dial to choose an option.
- When options are listed horizontally, press the [◀][▶] buttons or turn the [DIAL] dial to choose an option.

#### 5 Confirm your choice and exit.

- Press the [OK] button to confirm your choice and return to the menu item selection screen.
- Press the [MENU] button to return to the screen displayed before you pressed the [MENU] button in step 1.



- To undo any accidental setting changes, you can restore the camera's default settings (📖176).
- Available menu items vary depending on the selected shooting or playback mode (📖206 – 📖216).

## Touch-Screen Operations

- To choose tabs, press the [MENU] button to access the menu screen, and then touch the desired function tab and page tab.
- Drag the menu items up or down to scroll them, or touch a menu item to choose it.
- Touch an option to complete the setting and return to the menu item selection screen.
- For menu items displayed with a bar to indicate the level, touch the desired position on the bar.
- To configure menu items for which options are not shown, first touch the menu item to access the setting screen. On the setting screen, either drag or touch to choose the item, and then touch to choose the option. To return to the previous screen, touch [MENU←].
- You can also touch input elements (such as check boxes or text fields) to select them, and you can enter text by touching the on-screen keyboard.
- When [SET] is shown, you can touch [SET] instead of pressing the [OK] button, if you prefer.
- When [MENU] is shown, you can touch [MENU] instead of pressing the [MENU] button, if you prefer.
- When [INFO] is shown, the same operation is possible by touching [INFO] instead of pressing [▼].
- When [RING FUNC.] is shown, you can touch [RING FUNC.] instead of pressing the [RING FUNC.] button, if you prefer.
- To dismiss the menu, press the [MENU] button again.

Before Use

Basic Guide

Advanced Guide

Camera Basics

Auto Mode /  
Hybrid Auto Mode

Other Shooting Modes

P Mode

Tv, Av, M, and C Mode

Playback Mode

Wi-Fi Functions

Setting Menu

Accessories

Appendix

Index



## On-Screen Keyboard

Use the on-screen keyboard to enter information for Face ID (📖45), Wi-Fi connections (📖141), and so on. Note that the length and type of information you can enter varies depending on the function you are using.

### (1) Entering Characters

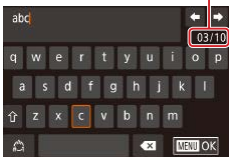

- Touch the characters to enter them.
- The amount of information you can enter (1) varies depending on the function you are using.

### Moving the Cursor

- Touch [←] or [→], or turn the [🌀] ring.

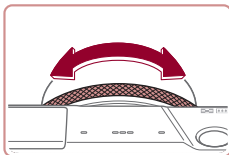

### Entering Line Breaks

- Touch [↵].

### Switching Input Modes

- To switch to numbers or symbols, touch [123].
- Touch [⇧] to enter capital letters.
- Available input modes vary depending on the function you are using.

### Deleting Characters

- To delete the previous character, either touch [⌫] or press the [🗑️] button.
- Touching and holding [⌫] will delete five characters at a time.

### Confirming Input and Returning to the Previous Screen

- Press the [MENU] button.



- For some functions, [↵] is not displayed and cannot be used.



- Another way to use the keyboard is by pressing the [▲][▼][◀][▶] buttons or turning the [🌀] dial to select characters or icons, and then pressing the [🗑️] button. You can also move the cursor by turning the [🌀] ring. To return to the previous screen, press the [MENU] button.

Before Use

Basic Guide

Advanced Guide

Camera Basics

Auto Mode / Hybrid Auto Mode

Other Shooting Modes

P Mode

Tv, Av, M, and C Mode

Playback Mode

Wi-Fi Functions

Setting Menu

Accessories

Appendix

Index



## Indicator Display

The indicator on the back of the camera (📖4) lights up or blinks depending on the camera status.

Color	Indicator Status	Camera Status
Green	Blinking	Starting up, recording/reading/transmitting images, shooting long exposures (📖100, 📖101), connected to a computer (📖182), connecting/transmitting via Wi-Fi, or display off (📖27, 📖171, 📖171)
Orange	On	Charging via USB



- When the indicator blinks green, never turn the camera off, open the memory card/battery cover, or shake or jolt the camera. This may corrupt images or damage the camera or memory card.

## Clock

You can check the current time.



- Press and hold the [📖] button.
- The current time appears.
- If you hold the camera vertically while using the clock function, it will switch to vertical display.
- Press the [◀][▶] buttons or turn the [📖] dial or turn the [📖] ring to change the display color.
- Press the [📖] button again to cancel the clock display.



- When the camera is off, press and hold the [📖] button, then press the power button to display the clock.

Before Use

Basic Guide

Advanced Guide

Camera Basics

Auto Mode /  
Hybrid Auto Mode

Other Shooting Modes

P Mode

Tv, Av, M, and C Mode

Playback Mode

Wi-Fi Functions

Setting Menu

Accessories

Appendix

Index



# Auto Mode / Hybrid Auto Mode

Convenient mode for easy shots with greater control over shooting

## Shooting with Camera-Determined Settings

For fully automatic selection of the optimal settings for specific scenes, simply let the camera determine the subject and shooting conditions.

### Shooting (Smart Auto)

▶ Still Images ▶ Movies

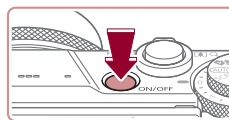

#### 1 Turn the camera on.

- Press the power button.
- The startup screen is displayed.

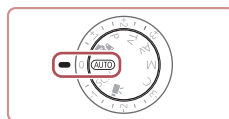

#### 2 Enter [AUTO] mode.

- Set the mode dial to [AUTO].
- Aim the camera at the subject. The camera will make a slight clicking noise as it determines the scene.
- Icons representing the scene and image stabilization mode are displayed in the upper left of the screen (📖38, 📖40).
- Frames displayed around any detected subjects indicate that they are in focus.



Before Use

Basic Guide

Advanced Guide

Camera Basics

Auto Mode / Hybrid Auto Mode

Other Shooting Modes

P Mode

Tv, Av, M, and C Mode

Playback Mode

Wi-Fi Functions

Setting Menu

Accessories

Appendix

Index





(1)



(2)

### 3 Compose the shot.

- To zoom in and enlarge the subject, move the zoom lever toward [T] (telephoto), and to zoom away from the subject, move it toward [W] (wide angle). (A zoom bar (1) showing the zoom position is displayed, along with the range of focus (2).)

### 4 Shoot.

#### Shooting Still Images

##### 1) Focus.

- Press the shutter button halfway. The camera beeps twice after focusing, and frames are displayed to indicate image areas in focus.
- Several frames are displayed when multiple areas are in focus.

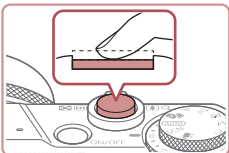

- If [Raise the flash] is displayed, move the [Flash] switch to raise the flash. It will fire when shooting. If you prefer not to use the flash, push it down with your finger, into the camera.

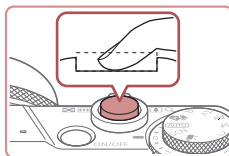

##### 2) Shoot.

- Press the shutter button all the way down.
- As the camera shoots, a shutter sound is played, and in low-light conditions when you have raised the flash, it fires automatically.
- Keep the camera still until the shutter sound ends.
- After displaying your shot, the camera will revert to the shooting screen.



(1)



#### Recording Movies

##### 1) Start recording.

- Press the movie button. The camera beeps once as recording begins, and [●Rec] is displayed with the elapsed time (1).
- Black bars are displayed on the top and bottom edges of the screen, and the subject is slightly enlarged. The black bars indicate image areas not recorded.
- Frames displayed around any detected faces indicate that they are in focus.
- Once recording begins, take your finger off the movie button.

Before Use

Basic Guide

Advanced Guide

Camera Basics

Auto Mode /  
Hybrid Auto Mode

Other Shooting Modes

P Mode

Tv, Av, M, and C Mode

Playback Mode

Wi-Fi Functions

Setting Menu

Accessories

Appendix

Index



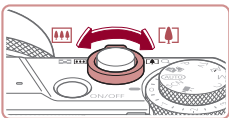

## 2) Resize the subject and recompose the shot as needed.

- To resize the subject, repeat the operations in step 3. However, note that the sound of camera operations will be recorded. Note that movies shot at zoom factors shown in blue will look grainy.
- When you recompose shots, the focus, brightness, and colors will be automatically adjusted.

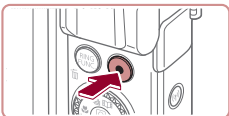

## 3) Finish recording.

- Press the movie button again to stop recording. The camera beeps twice as recording stops.
- Recording will stop automatically when the memory card becomes full.

## Shooting in Hybrid Auto Mode

► Still Images ► Movies

You can make a short movie of the day just by shooting still images. The camera records 2 – 4-second clips of scenes before each shot, which are later combined in a digest movie. Clips recorded in this mode may be included in Story Highlights albums (📖 136).

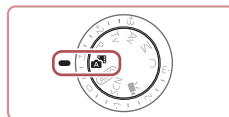

### 1 Enter [A] mode.

- Follow step 2 in “Shooting (Smart Auto)” (📖 34) and choose [A].



### 2 Compose the shot.

- Follow steps 3 – 4 in “Shooting (Smart Auto)” (📖 34) to compose the shot and focus.
- For more impressive digest movies, aim the camera at subjects about four seconds before shooting still images.

### 3 Shoot.

- Follow step 4 in “Shooting (Smart Auto)” (📖 34) to shoot a still image.
- The camera records both a still image and movie clip. The clip, which ends with the still image and a shutter sound, forms a single chapter in the digest movie.

Before Use

Basic Guide

Advanced Guide

Camera Basics

Auto Mode /  
Hybrid Auto Mode

Other Shooting Modes

P Mode

Tv, Av, M, and C Mode

Playback Mode

Wi-Fi Functions

Setting Menu

Accessories

Appendix

Index







- Battery life is shorter in this mode than in [AUTO] mode, because digest movies are recorded for each shot.
- A digest movie may not be recorded if you shoot a still image immediately after turning the camera on, choosing [S/AF] mode, or operating the camera in other ways.
- Sounds and vibrations from operating the camera will be recorded in digest movies.



- Digest movie image quality is automatically set to [HD 29.97P] for NTSC or [HD 25.00P] for PAL and cannot be changed (170).
- Sounds are not played when you press the shutter button halfway or trigger the self-timer (174).
- Digest movies are saved as separate movie files in the following cases even if they were recorded on the same day in [S/AF] mode.
  - The digest movie file size reaches approximately 4 GB, or the total recording time reaches approximately 16 minutes and 40 seconds.
  - The digest movie is protected (121).
  - Daylight saving time (20) or time zone (172) settings are changed.
  - A new folder is created (168).
- Recorded shutter sounds cannot be modified or erased.
- If you prefer to record digest movies without still images, adjust the setting in advance. Choose MENU (30) ► [7] tab ► [Digest Type] ► [No Stills].
- Individual chapters can be edited (135).

## Digest Movie Playback

Display a still image shot in [S/AF] mode to play the digest movie created on the same day, or specify the date of the digest movie to play (114).

## Still Images/Movies



- If the camera makes no operating sounds, it may have been turned on while holding down [▼]. To activate sounds, press the [MENU] button, choose [Mute] on the [3] tab, and then choose [Off].

## Still Images



- A blinking [9] icon warns that images are more likely to be blurred by camera shake. In this case, mount the camera on a tripod or take other measures to keep it still.
- If your shots are dark despite the flash firing, move closer to the subject. For details on the flash range, see “Camera” (217).
- The subject may be too close if the camera only beeps once when you press the shutter button halfway. For details on the range of focus (shooting range), see “Shooting Range” (219).
- To reduce red-eye and to assist in focusing, the lamp may be lit when shooting in low-light conditions.
- A blinking [4] icon displayed when you attempt to shoot indicates that shooting is not possible until the flash has finished recharging. Shooting can resume as soon as the flash is ready, so either press the shutter button all the way down and wait, or release it and press it again.
- No shutter sound is played when “Sleeping” and “Sleeping Babies” icons (38) are displayed.
- Although you can shoot again before the shooting screen is displayed, your previous shot may determine the focus, brightness, and colors used.



- You can change how long images are displayed after shots (54).

Before Use

Basic Guide

Advanced Guide

Camera Basics

Auto Mode / Hybrid Auto Mode

Other Shooting Modes

P Mode

Tv, Av, M, and C Mode

Playback Mode

Wi-Fi Functions

Setting Menu

Accessories

Appendix

Index





- Before movie recording, lower the flash with your finger. During recording, keep your fingers away from the microphone (1). Leaving the flash raised, or blocking the microphone may prevent audio from being recorded or may cause the recording to sound muffled.

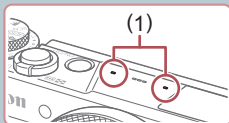

- Avoid touching camera controls other than the movie button when recording movies, because sounds made by the camera will be recorded.
- Once movie recording begins, the image display area changes and subjects are enlarged to allow for correction of significant camera shake. To record subjects at the same size shown before recording, follow the steps in "Recording Movies with Subjects at the Same Size Shown before Shooting" (p.53).



- Audio is recorded in stereo.

## Scene Icons

► Still Images ► Movies

In **[M]** and **[AUTO]** modes, shooting scenes determined by the camera are indicated by the icon displayed, and corresponding settings are automatically selected for optimal focusing, subject brightness, and color. Depending on the scene, continuous images may be shot (p.39).

Subject	Background				
	Normal	Backlit	Dark*1	Sunsets	Spotlights
People	*2	*3		—	
Moving People	*3	*3	—	—	—
Shadows on Face	*2	—	—	—	—
Smiling	*3	*3	—	—	—
Sleeping	*2	*3	—	—	—
Babies	*3	*3	—	—	—
Smiling Babies	*3	*3	—	—	—
Sleeping Babies	*2	*3	—	—	—
Moving Children	*3	*3	—	—	—
Other Subjects	*2	*3			
Other Moving Subjects	*3	*3	—	—	—
Other Close-Range Subjects	*2	*3	—	—	

\*1 Tripod used.

\*2 The background color of icons is light blue when the background is a blue sky, dark blue when the background is dark, and gray for all other backgrounds.

\*3 The background color of icons is light blue when the background is a blue sky, and gray for all other backgrounds.

- The background color of , , , , and is dark blue, and the background color of is orange.
- For movies, only People, Other Subjects, and Other Close-Range Subjects icons are displayed.
- In **[M]** mode, icons are only displayed for People, Shadows on Face, Other Subjects, and Other Close-Range Subjects.

Before Use

Basic Guide

Advanced Guide

Camera Basics

Auto Mode / Hybrid Auto Mode

Other Shooting Modes

P Mode

Tv, Av, M, and C Mode

Playback Mode

Wi-Fi Functions

Setting Menu

Accessories

Appendix

Index





- For self-timer shots, icons are not displayed for the following subjects: moving, smiling, or sleeping people; smiling or sleeping babies; moving children; and other moving subjects.
- Icons are not displayed for smiling or sleeping subjects and moving children in drive modes other than [A] (p39, p44).
- Backlit icons are not displayed for moving children and smiling people when the flash is set to [A].
- Icons for babies (including smiling and sleeping babies) and moving children are displayed when [Face ID] is set to [On] and faces of registered babies (less than two years old) or children (2 – 12 years old) are detected (p45). Confirm beforehand that the date and time are correct (p20).



- The scene icon may not match actual shooting conditions, or it may not be possible to shoot with your expected effect, color, or brightness. In these cases, it is recommended that you shoot in [P] mode (p77).

## Continuous Shooting Scenes

If the icon for one of the following scenes (in table's left column) is displayed when you shoot a still image, the camera shoots continuously. If the icon for one of the following scenes (in table's left column) is displayed when you press the shutter button halfway, one of the icons [A], [A], or [A] is displayed to inform you that the camera shoots continuously.

Smiling (including Babies)	 Consecutive images are captured, and the camera analyzes details such as facial expressions to save the image determined to be the best.
Sleeping (including Babies)	 Beautiful shots of sleeping faces, created by combining consecutive shots to reduce camera shake and image noise. The AF-assist beam and the flash will not fire. Also, the shutter sound will not be played.
Children	 So you don't miss a photo opportunity of children who move around, the camera will capture three consecutive images for each shot.



- In some scenes, expected images may not be saved, and images may not look as expected.
- Focus, image brightness, and color are determined by the first shot.



- When you want to shoot single images only, press the [▲] button, and then select [ ] (either press the [◀] [▶] buttons or turn the [●] dial).

Before Use

Basic Guide

Advanced Guide

Camera Basics

Auto Mode /  
Hybrid Auto Mode

Other Shooting Modes

P Mode

Tv, Av, M, and C Mode

Playback Mode

Wi-Fi Functions

Setting Menu

Accessories

Appendix









Index



## Image Stabilization Icons



▶ Still Images ▶ Movies

Optimal image stabilization for the shooting conditions (Intelligent IS) is automatically applied, and the following icons are displayed.

	Image stabilization for still images (Normal)
	Image stabilization for still images when panning (Panning)*
	Image stabilization for angular camera shake and shift-shake in macro shots (Hybrid IS). For movies,  is displayed and  image stabilization is also applied.
	Image stabilization for movies, reducing strong camera shake, as when recording while walking (Dynamic)
	Image stabilization for slow camera shake, such as when recording movies at telephoto (Powered)
	No image stabilization, because the camera is mounted on a tripod or held still by other means. However, during movie recording,  is displayed, and image stabilization to counteract wind or other sources of vibration is used (Tripod IS).

\* Displayed when you pan, following moving subjects with the camera. When you follow subjects moving horizontally, image stabilization only counteracts vertical camera shake, and horizontal stabilization stops. Similarly, when you follow subjects moving vertically, image stabilization only counteracts horizontal camera shake.



- To cancel image stabilization, set [IS Mode] to [Off] (p.52). In this case, an IS icon is not displayed.
- In  mode, no  icon is displayed.

## On-Screen Frames

▶ Still Images ▶ Movies

In [AUTO] mode, a variety of frames are displayed once the camera detects subjects you are aiming the camera at.

- A white frame is displayed around the subject (or person's face) determined by the camera to be the main subject, and gray frames are displayed around other detected faces. Frames follow moving subjects within a certain range to keep them in focus. However, if the camera detects subject movement, only the white frame will remain on the screen.
- When you are pressing the shutter button halfway and the camera detects subject movement, a blue frame is displayed, and the focus and image brightness are constantly adjusted (Servo AF).



- Depending on the shooting conditions and subject, no frames may be displayed, frames may not be displayed around desired subjects, or frames may be displayed on the background or similar areas. In these cases, it is recommended that you shoot in [P] mode (p.77).
- To choose subjects to focus on, touch the desired subject on the screen.  is displayed, and the camera enters Touch AF mode (p.93). Pressing the shutter button halfway will display a blue frame, and the camera will keep the subject in focus and image brightness adjusted (Servo AF).

Before Use

Basic Guide

Advanced Guide

Camera Basics

Auto Mode /  
Hybrid Auto Mode

Other Shooting Modes

P Mode

Tv, Av, M, and C Mode

Playback Mode

Wi-Fi Functions

Setting Menu

Accessories

Appendix

Index



## Common, Convenient Features

### Zooming In Closer on Subjects (Digital Zoom)

► Still Images ► Movies

When distant subjects are too far away to enlarge using the optical zoom, use digital zoom for up to about 17x enlargement.

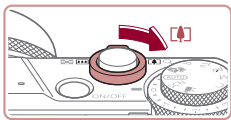

#### 1 Move the zoom lever toward [Z].

- Hold the lever until zooming stops.
- Zooming stops at the largest zoom factor before the image becomes noticeably grainy, which is then indicated on the screen.

#### 2 Move the zoom lever toward [Z] again.

- The camera zooms in even closer on the subject.
- (1) is the current zoom factor.

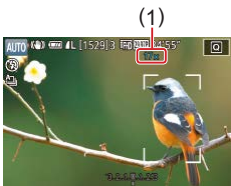

- ! Moving the zoom lever will display the zoom bar (which indicates the zoom position). The zoom bar is color-coded to indicate the zoom range.
  - White range: optical zoom range where the image will not appear grainy.
  - Yellow range: digital zoom range where the image is not noticeably grainy (ZoomPlus).
  - Blue range: digital zoom range where the image will appear grainy.
- Because the blue range will not be available at some recording pixel settings (p.97), the maximum zoom factor can be achieved by following step 1.



- To deactivate digital zoom, choose MENU (p.30) ► [3] tab ► [Digital Zoom] ► [Off].

### Shooting at Preset Focal Lengths (Step Zoom)

► Still Images ► Movies

Shoot at common focal lengths in a range of 24 – 100 mm (35mm film equivalent).

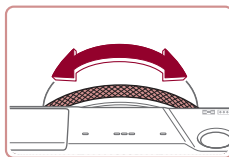

- To change the focal length from 24 to 28 mm, turn the [Z] ring counterclockwise until it clicks. Turn the [Z] ring counterclockwise to zoom in or clockwise to zoom out.



- Step zoom is not available when recording movies even if you turn the [Z] ring.



- When you are using digital zoom (p.41), you cannot adjust the zoom factor by turning the [Z] ring counterclockwise. However, you can set the focal length to 100 mm by turning it clockwise.

### Changing the Way the Control of the Camera Feels with the Step/Continuous Selection Lever

You can change how the control of the camera feels when you turn the control ring.

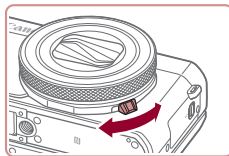

- When you lower the selection lever, the clicking of the control ring will stop and you will be able to turn it smoothly.

Before Use

Basic Guide

Advanced Guide

Camera Basics

Auto Mode / Hybrid Auto Mode

Other Shooting Modes

P Mode

Tv, Av, M, and C Mode

Playback Mode

Wi-Fi Functions

Setting Menu

Accessories

Appendix

Index



## Resizing the Subject with the Control Ring

► Still Images ► Movies

By assigning seamless zoom to the control ring, you can further fine-tune the size of the subject or zoom in or out faster than would be possible with the zoom lever.

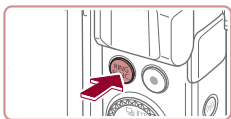

### 1 Configure the setting.

- Press the **RING [FUNC.]** button.
- Press the **RING [FUNC.]** or **[<|>]** buttons, or turn the **[Z]** ring or the **[ZOOM]** dial to choose **[Zoom]**.
- Press the **[SET]** button to complete the setting.

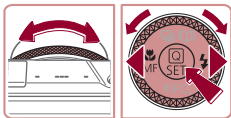
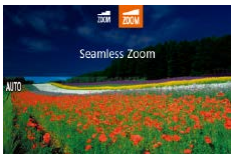

### 2 Compose the shot.

- To adjust to telephoto, turn the **[Z]** ring counterclockwise, and to adjust to wide angle, turn it clockwise.

## Using the Self-Timer

► Still Images ► Movies

With the self-timer, you can include yourself in group photos or other timed shots. The camera will shoot about 10 seconds after you press the shutter button.



### 1 Configure the setting.

- Press the **[SET]** button, choose **[Self-Timer]** in the menu, and then choose **[10s]** (p. 29).
- Once the setting is complete, **[10s]** is displayed.



### 2 Shoot.

- For Still Images: Press the shutter button halfway to focus on the subject, and then press it all the way down.
- For Movies: Press the movie button.
- Once you start the self-timer, the lamp will blink and the camera will play a self-timer sound.
- Two seconds before the shot, the blinking and sound will speed up. (The lamp will remain lit in case the flash fires.)
- To cancel shooting after you have triggered the self-timer, press the **[MENU]** button.
- To restore the original setting, choose **[Self-Timer]** in step 1.



Before Use

Basic Guide

Advanced Guide

Camera Basics

Auto Mode / Hybrid Auto Mode

Other Shooting Modes

P Mode

Tv, Av, M, and C Mode

Playback Mode

Wi-Fi Functions

Setting Menu

Accessories

Appendix

Index



## Using the Self-Timer to Avoid Camera Shake

► Still Images ► Movies

This option delays shutter release until about two seconds after you have pressed the shutter button. If the camera is unsteady while you are pressing the shutter button, it will not affect your shot.

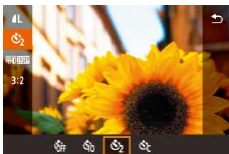

- Follow step 1 in “Using the Self-Timer” (42) and choose [C].
- Once the setting is complete, [C] is displayed.

## Customizing the Self-Timer

► Still Images ► Movies

You can specify the delay (0 – 30 seconds) and number of shots (1 – 10).

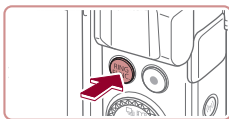

### 1 Choose [C].

- Following step 1 in “Using the Self-Timer” (42), choose [C] and press the [FUNC.] button.



### 2 Configure the setting.

- Press the [▲][▼] buttons to choose the delay time or number of shots.
- Press the [◀][▶] buttons or turn the [DISP.] dial to choose a value, and then press the [DISP.] button twice.
- Once the setting is complete, [C] is displayed.
- Follow step 2 in “Using the Self-Timer” (42) to shoot.



- For movies recorded using the self-timer, recording begins after your specified delay time, but specifying the number of shots has no effect.



- When you specify multiple shots, image brightness and white balance are determined by the first shot. More time is required between shots when the flash fires or when you have specified to take many shots. Shooting will stop automatically when the memory card becomes full.
- When a delay longer than two seconds is specified, two seconds before the shot, the lamp blinking and self-timer sound will speed up. (The lamp will remain lit in case the flash fires.)

Before Use

Basic Guide

Advanced Guide

Camera Basics

Auto Mode / Hybrid Auto Mode

Other Shooting Modes

P Mode

Tv, Av, M, and C Mode

Playback Mode

Wi-Fi Functions

Setting Menu

Accessories

Appendix

Index



## Shooting by Touching the Screen (Touch Shutter)

▶ Still Images ▶ Movies

With this option, instead of pressing the shutter button, you can simply touch the screen and release your finger to shoot. The camera will focus on subjects and adjust image brightness automatically.

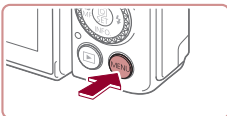

### 1 Enable the Touch Shutter function.

- Press the [MENU] button, choose [Touch Shutter] on the [CAMERA] tab, and then choose [Enable] (30).

### 2 Shoot.

- Touch the subject on the screen, and then lift your finger immediately.
- The camera shoots, as a shutter sound is played.
- To cancel Touch Shutter, choose [Disable] in step 1.



- Even while the shot is displayed, you can prepare for the next shot by touching [REVIEW].

## Continuous Shooting

▶ Still Images ▶ Movies

In [AUTO] mode, hold the shutter button all the way down to shoot continuously.

For details on the continuous shooting speed, see “Camera” (217).

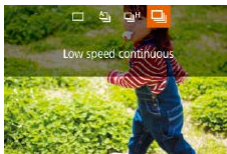

### 1 Configure the setting.

- Press the [▲] button, choose [CAMERA] or [MOVIE] (either press the [◀][▶] buttons or turn the [DIAL], and then press the [SET] button.
- Once the setting is complete, [CAMERA] or [MOVIE] is displayed.

### 2 Shoot.

- Hold the shutter button all the way down to shoot continuously.



- During continuous shooting, the focus, exposure, and colors are locked at the position/level determined when you pressed the shutter button halfway.
- Cannot be used with the self-timer (42).
- Shooting may stop momentarily or continuous shooting may slow down depending on shooting conditions, camera settings, and the zoom position.
- As more shots are taken, shooting may slow down.
- Shooting may slow down if the flash fires.
- With Touch Shutter (44), the camera shoots continuously while you touch the screen. Focus and exposure during continuous shooting remain constant, after they are determined for the first shot.

Before Use

Basic Guide

Advanced Guide

Camera Basics

Auto Mode / Hybrid Auto Mode

Other Shooting Modes

P Mode

Tv, Av, M, and C Mode

Playback Mode

Wi-Fi Functions

Setting Menu

Accessories

Appendix

Index





## Using Face ID

If you register a person ahead of time, the camera will detect that person's face, and prioritize focus, brightness, and color for that person when shooting. In [AUTO] mode, the camera can detect babies and children based on registered birthdays and optimize settings for them when shooting.

This function is also useful when searching for a specific registered person among a large number of images (📖115).

It is recommended to register information in advance so that images can be selected easily for Story Highlights (📖136) albums.

## Personal Information

- Information such as images of a face (face info) registered with Face ID, and personal information (name, birthday) will be saved on the camera. Additionally, when registered people are detected, their names will be recorded in still images. When using the Face ID function, be careful when sharing the camera or images with others, and when posting images online where many others can view them.
- When disposing of a camera or transferring it to another person after using Face ID, be sure to erase all information (registered faces, names, and birthdays) from the camera (📖49).

## Registering Face ID Information

You can register information (face info, names, and birthdays) for up to 12 people to use with Face ID.

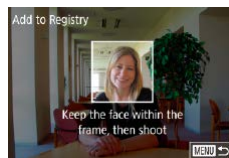
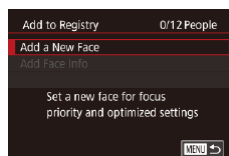
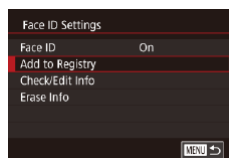
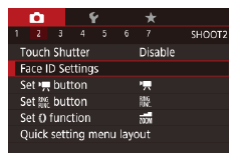

### 1 Access the setting screen.

- Press the [MENU] button, choose [Face ID Settings] on the [📷2] tab, and then press the [📖] button (📖30).

- Press the [▲][▼] buttons or turn the [📷] dial to choose [Add to Registry], and then press the [📖] button.

- Press the [▲][▼] buttons or turn the [📷] dial to choose [Add a New Face], and then press the [📖] button.

### 2 Register face information.

- Aim the camera so that the face of the person you want to register is inside the gray frame at the center of the screen.
- A white frame on the person's face indicates that the face is recognized. Make sure a white frame is displayed on the face, and then shoot.
- If the face is not recognized, you cannot register face information.

Before Use

Basic Guide

Advanced Guide

Camera Basics

Auto Mode / Hybrid Auto Mode

Other Shooting Modes

P Mode

Tv, Av, M, and C Mode

Playback Mode

Wi-Fi Functions

Setting Menu

Accessories

Appendix

Index



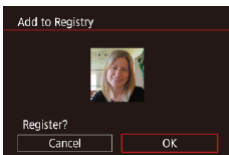

- After [Register?] is displayed, press the [◀][▶] buttons or turn the [DISP] dial to choose [OK], and then press the [MENU] button.
- The [Edit Profile] screen is displayed.

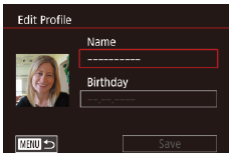

### 3 Register the person's name and birthday.

- Press the [MENU] button to access the keyboard, and then enter the name (p.32).



- To register a birthday, on the [Edit Profile] screen, choose [Birthday] (either press the [▲][▼] buttons or turn the [DISP] dial), and then press the [MENU] button.
- Press the [◀][▶] buttons to choose an option.
- Press the [▲][▼] buttons or turn the [DISP] dial to specify the date.
- When finished, press the [MENU] button.

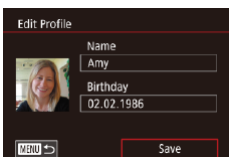

### 4 Save the settings.

- Press the [▲][▼] buttons or turn the [DISP] dial to choose [Save], and then press the [MENU] button.
- After a message is displayed, press the [◀][▶] buttons or turn the [DISP] dial to choose [Yes], and then press the [MENU] button.

## 5 Continue registering face information.

- To register up to 4 more points of face information (expressions or angles), repeat step 2.
- Registered faces are more easily recognized if you add a variety of face information. In addition to a head-on angle, add a slight side angle, a shot when smiling, and shots inside and outside.



- The flash will not fire when following step 2.
- If you do not register a birthday in step 3, Babies or Children icons (p.38) will not be displayed in [AUTO] mode.



- You can overwrite registered face info, and add face info later if you have not filled all 5 face info slots (p.45).

## Shooting

If you register a person ahead of time, the camera will prioritize that person as the main subject, and optimize focus, brightness, and color for that person when shooting.



- When you point the camera toward people, the names of up to 3 registered people will be displayed when they are detected.
- Shoot.
- Displayed names will be recorded in still images. The names of detected people (maximum total of 5) will be recorded, even if the names are not displayed.

Before Use

Basic Guide

Advanced Guide

Camera Basics

Auto Mode / Hybrid Auto Mode

Other Shooting Modes

P Mode

Tv, Av, M, and C Mode

Playback Mode

Wi-Fi Functions

Setting Menu

Accessories

Appendix

Index





- People other than those registered may be mistakenly detected as the registered person if they share similar facial features.



- Registered people may not be correctly detected if the captured image or scene differs drastically from the registered face information.
- If a registered face is not detected, or not easily detected, overwrite registered information with new face info. Registering face info right before shooting will allow for easier detection of registered faces.
- If a person is mistakenly detected as another person and you continue shooting, you can edit or erase the name recorded in the image during playback (📖118).
- Because faces of babies and children change quickly as they grow, you should update their face info regularly (📖45).
- Names will still be recorded in images even if you clear the [Shooting Info] check box in “Customizing the Information Displayed” (📖106) so that the names are not displayed.
- If you don’t want names to be recorded in images, choose [Face ID Settings] on the [📷2] tab, choose [Face ID], and then choose [Off].
- You can check names recorded in images in the playback screen (simple information display) (📖112).
- Names recorded in continuous shooting (📖44) continue to be recorded in the same position as the first shot, even if subjects move.

## Checking and Editing Registered Information

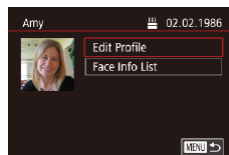
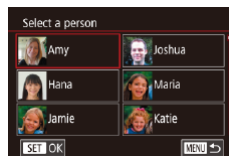
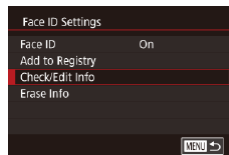

### 1 Access the [Check/Edit Info] screen.

- Following step 1 in “Registering Face ID Information” (📖45), choose [Check/Edit Info].

### 2 Choose a person to check or edit their information.

- Press the [▲][▼][◀][▶] buttons to choose the person whose information you want to check or edit, and then press the [👤] button.

### 3 Check or edit the information as needed.

- To check a name or birthday, choose [Edit Profile] (either press the [▲][▼] buttons or turn the [📷] dial), and then press the [👤] button. On the screen displayed, you can edit the name or birthday as described in step 3 of “Registering Face ID Information” (📖45).
- To check face information, choose [Face Info List] (either press the [▲][▼] buttons or turn the [📷] dial), and then press the [👤] button. Press the [👤] button on the screen displayed, choose face information to erase by pressing the [▲][▼][◀][▶] buttons or turning the [📷] dial, and then press the [👤] button. [Erase?] is displayed. To erase face information, press the [◀][▶] buttons or turn the [📷] dial to choose [OK], and then press the [👤] button.

Before Use

Basic Guide

Advanced Guide

Camera Basics

Auto Mode / Hybrid Auto Mode

Other Shooting Modes

P Mode

Tv, Av, M, and C Mode

Playback Mode

Wi-Fi Functions

Setting Menu

Accessories

Appendix

Index





- Even if you change names in [Edit Profile], the names recorded in previously shot images will remain the same.

## Overwriting and Adding Face Information

You can overwrite existing face information with new face info. You should update face information regularly, especially with babies and children, as their faces change quickly as they grow.

You can also add face information when all 5 face info slots have not been filled.

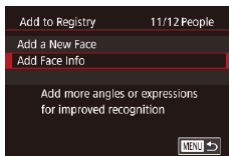

### 1 Access the [Add Face Info] screen.

- Following step 1 in “Registering Face ID Information” (45), choose [Add Face Info].

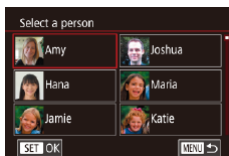

### 2 Choose a person to overwrite their face info.

- Press the [▲][▼][◀][▶] buttons to choose the name of the person whose face info you want to overwrite, and then press the [SET] button.
- If five items of face info have already been registered, a message will be displayed. Choose [OK] (either press the [◀][▶] buttons or turn the [DIAL] dial), and then press the [SET] button.
- If less than five items of face info are registered, go to step 4 to add face information.

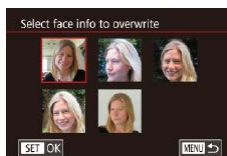

### 3 Choose the face info to overwrite.

- Press the [▲][▼][◀][▶] buttons or turn the [DIAL] dial to choose the face info to overwrite, and then press the [SET] button.

### 4 Register face information.

- Follow step 2 in “Registering Face ID Information” (45) to shoot, and then register the new face information.
- Registered faces are more easily recognized if you add a variety of face information. In addition to a head-on angle, add a slight side angle, a shot when smiling, and shots inside and outside.



- You cannot add face information if all 5 information slots are filled. Follow the steps above to overwrite face information.
- You can follow the above steps to register new face info when there is at least one slot open; however, you cannot overwrite any face information. Instead of overwriting face info, first erase unwanted existing info (49), and then register new face information (45) as needed.

Before Use

Basic Guide

Advanced Guide

Camera Basics

Auto Mode / Hybrid Auto Mode

Other Shooting Modes

P Mode

Tv, Av, M, and C Mode

Playback Mode

Wi-Fi Functions

Setting Menu

Accessories

Appendix

Index



## Erasing Registered Information

You can erase information (face info, names, and birthdays) registered to Face ID. However, names recorded in previously shot images will not be erased.

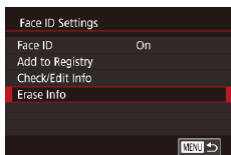

### 1 Access the [Erase Info] screen.

- Follow step 1 in “Registering Face ID Information” (📖45) and choose [Erase Info].

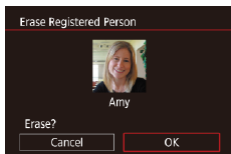

### 2 Choose a person to erase their information.

- Press the [▲][▼][◀][▶] buttons to choose the name of the person to erase, and then press the [SET] button.
- After [Erase?] is displayed, press the [◀][▶] buttons or turn the [DIAL] dial to choose [OK], and then press the [SET] button.



- If you erase a registered person's info, you will not be able to display their name (📖114), overwrite their info (📖118), or search for images that include them (📖115).



- You can also erase names in image information (📖119).

## Image Customization Features

### Changing the Aspect Ratio

▶ Still Images ▶ Movies

Change the image aspect ratio (ratio of width to height) as follows.



- Press the [SET] button, choose [3:2] in the menu, and choose the desired option (📖29).
- Once the setting is complete, the screen aspect ratio will be updated.
- To restore the original setting, repeat this process but choose [3:2].

16:9	Used for display on widescreen HDTVs or similar display devices.
3:2	Native aspect ratio of the camera screen. Same aspect ratio as 35mm film. Used for printing images at 5 x 7-inch or postcard sizes.
4:3	Used for display on standard-definition televisions or similar display devices. Also used for printing images at 3.5 x 5-inch or A-series sizes.
1:1	Square aspect ratio.



- Not available in [A] mode.
- You can also configure this setting by choosing MENU (📖30) ▶ [📷] tab ▶ [Still Image Aspect Ratio].

Before Use

Basic Guide

Advanced Guide

Camera Basics

Auto Mode /  
Hybrid Auto Mode

Other Shooting Modes

P Mode

Tv, Av, M, and C Mode

Playback Mode

Wi-Fi Functions

Setting Menu

Accessories

Appendix

Index



## Changing Image Quality

▶ Still Images ▶ Movies

Choose from 4 levels of image quality. For guidelines on how many of each kind of image can fit on a memory card, see “Number of Shots per Memory Card” (1220).



- Press the button, choose in the menu, and choose the desired option (1229).
- The option you configured is now displayed.
- To restore the original setting, repeat this process but choose .

When deciding the number of pixels based on print size, use the following table as a guide for images with a 3:2 aspect ratio.

<b>L</b>	A2 (16.5 x 23.4 in.)
<b>M</b>	A3 (11.7 x 16.5 in.)
<b>S1</b>	A4 (8.3 x 11.7 in.)
<b>S2</b>	3.5 x 5 in., 5 x 7 in., Postcard



- Not available in mode.
- You can also change the image quality by accessing MENU (130) ▶ tab ▶ [Image quality].

## Changing Movie Image Quality

▶ Still Images ▶ Movies

Adjust movie image quality (image size and frame rate). The frame rate indicates how many frames are recorded per second, which is determined automatically based on the NTSC or PAL setting (1170). For guidelines on the total recording time for movies at each level of image quality that will fit on a memory card, see “Recording Time per Memory Card” (1220).



- Press the button, choose the movie quality menu item, and then choose the desired option (1229).
- The option you configured is now displayed.

### For NTSC Video

Image Quality	Number of Recording Pixels	Frame Rate	Details
FHD 59.94P	1920 x 1080	59.94 fps	For shooting in Full HD.  enables movies with smoother motion.
FHD 29.97P	1920 x 1080	29.97 fps	
FHD 23.98P	1920 x 1080	23.98 fps	
HD 29.97P	1280 x 720	29.97 fps	For shooting in HD.
VCA 29.97P	640 x 480	29.97 fps	For shooting in standard definition.

Before Use

Basic Guide

Advanced Guide

Camera Basics

Auto Mode / Hybrid Auto Mode

Other Shooting Modes

P Mode

Tv, Av, M, and C Mode

Playback Mode

Wi-Fi Functions

Setting Menu

Accessories

Appendix

Index



## For PAL Video

Image Quality	Number of Recording Pixels	Frame Rate	Details
[FHD 50.00P]	1920 x 1080	50.00 fps	For shooting in Full HD.
[FHD 25.00P]	1920 x 1080	25.00 fps	
[HD 25.00P]	1280 x 720	25.00 fps	For shooting in HD.
[VGA 25.00P]	640 x 480	25.00 fps	For shooting in standard definition.



- There are black bars displayed on the left and right in [VGA 29.97P] and [VGA 25.00P] modes and on the top and bottom in [FHD 59.94P], [FHD 29.97P], [FHD 23.98P], [FHD 29.97P], [FHD 50.00P], [FHD 25.00P], and [HD 25.00P] modes. They indicate that this image area cannot be recorded.
- You can also configure this setting by choosing MENU ([M] 30) ► [7] tab ► [Movie rec. size].

## Helpful Shooting Features

### Using the Dual Axis Electronic Level

► Still Images ► Movies

An electronic level can be displayed as a guideline to ensure the camera is level from front to back and left to right.



(1) (2)

#### 1 Display the electronic level.

- Press the [▼] button several times to display the electronic level.

#### 2 Straighten the camera.

- (1) indicates the front-back orientation and (2) the left-right orientation.
- If the camera is tilted, move it so that the red line changes to green.



- If the electronic level is not displayed in step 1, press the [MENU] button and check the setting in [7] tab ► [Shooting information display].
- The electronic level is not displayed during movie recording.
- If you hold the camera vertically, the orientation of the electronic level will be updated automatically to match the camera orientation.
- Calibrate the electronic level if it seems ineffective in helping you level the camera ([170]).
- Not available in [5] mode.

Before Use

Basic Guide

Advanced Guide

Camera Basics

Auto Mode / Hybrid Auto Mode

Other Shooting Modes

P Mode

Tv, Av, M, and C Mode

Playback Mode

Wi-Fi Functions

Setting Menu

Accessories

Appendix

Index



## Deactivating Auto Level

▶ Still Images ▶ Movies

Normally, auto leveling keeps movies straight during recording. To cancel this feature, choose [Disable].



- Press the [MENU] button, choose [Auto level] on the [CAMERA] tab, and then press the [OK] button (p.30).
- Choose [Disable], and press the [OK] button again (p.30).



- Once movie recording begins, the image display area changes and subjects are enlarged (p.53).

## Changing the IS Mode Settings

### Deactivating Image Stabilization

▶ Still Images ▶ Movies

When the camera is held still (as when shooting from a tripod), you should set image stabilization to [Off] to deactivate it.

#### 1 Access the setting screen.

- Press the [MENU] button, choose [IS Settings] on the [CAMERA] tab, and then press the [OK] button (p.30).

#### 2 Configure the setting.

- Press the [▲][▼] buttons or turn the [DISP.] dial to choose [IS Mode], press the [OK] button, and then press the [▲][▼] buttons or turn the [DISP.] dial to choose the desired option (p.30).

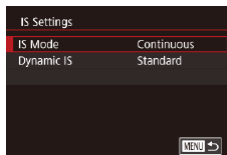

Continuous	Optimal image stabilization for the shooting conditions is automatically applied (Intelligent IS) (p.40).
Off	Deactivates image stabilization.

Before Use

Basic Guide

Advanced Guide

Camera Basics

Auto Mode /  
Hybrid Auto Mode

Other Shooting Modes

P Mode

Tv, Av, M, and C Mode

Playback Mode

Wi-Fi Functions

Setting Menu

Accessories

Appendix

Index





## Recording Movies with Subjects at the Same Size Shown before Shooting

▶ Still Images ▶ Movies

Normally, once movie recording begins, the image display area changes and subjects are enlarged to allow for image straightening and correction of significant camera shake.

To record movies with subjects at the same size shown before shooting, you can reduce image stabilization and cancel Auto Level.

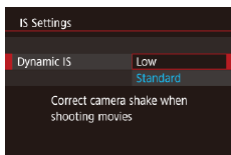

- Set [Auto level] to [Disable] as described in “Deactivating Auto Level” (52).
- Follow step 1 in “Deactivating Image Stabilization” (52) to access the [IS Settings] screen.
- Choose [Dynamic IS], and then choose [Low] (30).



- You can also set [IS Mode] to [Off], so that subjects are recorded at the same size shown before shooting.
- [Dynamic IS] is not available when [IS Mode] is set to [Off] (52).
- Only [Standard] is available when the movie quality is [AVC 29.97P] (NTSC) or [AVC 25.00P] (PAL).

## Customizing Camera Operation

Customize shooting functions on the [CAMERA] tab of the menu screen as follows.

For instructions on menu functions, see “Using the Menu Screen” (30).

### Preventing the AF-Assist Beam from Firing

▶ Still Images ▶ Movies

You can deactivate the lamp that normally lights up to help you focus when you press the shutter button halfway in low-light conditions.

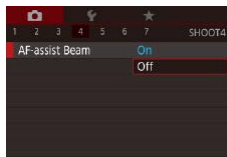

- Press the [MENU] button, choose [AF-assist Beam] on the [CAMERA] tab, and then choose [Off].
- To restore the original setting, repeat this process but choose [On].

Before Use

Basic Guide

Advanced Guide

Camera Basics

Auto Mode / Hybrid Auto Mode

Other Shooting Modes

P Mode

Tv, Av, M, and C Mode

Playback Mode

Wi-Fi Functions

Setting Menu

Accessories

Appendix

Index



## Preventing the Red-Eye Reduction Lamp from Lighting Up

▶ Still Images ▶ Movies

You can deactivate the red-eye reduction lamp that lights up to reduce red-eye when the flash is used in low-light shots.

### 1 Access the [Flash Settings] screen.

- Press the [MENU] button, choose [Flash Settings] on the [CAMERA] tab, and then press the [INFO] button.

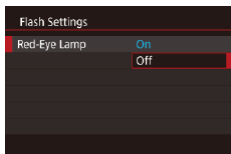

### 2 Configure the setting.

- Choose [Red-Eye Lamp], and then choose [Off].
- To restore the original setting, repeat this process but choose [On].

## Changing the Image Display Style after Shots

▶ Still Images ▶ Movies

You can change how long images are displayed after shots.

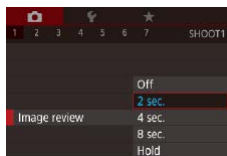

- Press the [MENU] button, choose [Image review] on the [CAMERA] tab, and then choose the desired option.
- To restore the original setting, repeat this process but choose [2 sec.].

2 sec., 4 sec., 8 sec.	Displays images for the specified time. Even while the shot is displayed, you can take another shot by pressing the shutter button halfway again.
Hold	Displays images until you press the shutter button halfway.
Off	No image display after shots.



- By pressing the [▼] button while an image is displayed after shooting, you can switch the display information.

Before Use

Basic Guide

Advanced Guide

Camera Basics

Auto Mode /  
Hybrid Auto Mode

Other Shooting Modes

P Mode

Tv, Av, M, and C Mode

Playback Mode

Wi-Fi Functions

Setting Menu

Accessories

Appendix

Index



## Other Shooting Modes

Shoot more effectively in various scenes, and take shots enhanced with unique image effects or captured using special functions

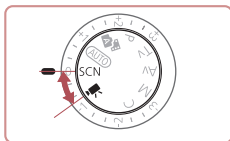

## Specific Scenes

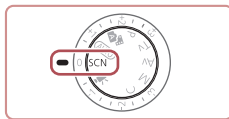

Choose a mode matching the shooting scene, and the camera will automatically configure the settings for optimal shots.



### 1 Enter [SCN] mode.

- Set the mode dial to [SCN].

### 2 Choose a shooting mode.

- Press the  button, choose  in the menu, and then choose a shooting mode (29).

### 3 Shoot.



- Turn the mode dial to [SCN]. You can also choose the shooting mode by touching  in the upper left.

Before Use

Basic Guide

Advanced Guide

Camera Basics

Auto Mode /  
Hybrid Auto Mode

Other Shooting Modes

P Mode

Tv, Av, M, and C Mode

Playback Mode

Wi-Fi Functions

Setting Menu

Accessories

Appendix

Index





## Shooting Portraits (Portrait)

▶ Still Images ▶ Movies

- Take shots of people with a softening effect.



## Shooting Evening Scenes without Using a Tripod (Handheld Night Scene)

▶ Still Images ▶ Movies

- Beautiful shots of evening scenes or portraits with evening scenery in the background, without the need to hold the camera very still (as with a tripod).
- A single image is created by combining consecutive shots, reducing camera shake and image noise.



## Shooting Underwater (Underwater)

▶ Still Images ▶ Movies

- Natural-colored shots of sea life and underwater scenery, when you use an optional waterproof case (178).
- This mode can correct white balance and match the effect of using a commercially available color-compensating filter (57).



## Shooting Fireworks (Fireworks)

▶ Still Images ▶ Movies

- Vivid shots of fireworks.



- Subjects appear larger in [P] mode compared to other modes.
- In [P] and [S] mode, shots may look grainy because the ISO speed (80) is increased to suit the shooting conditions.
- Because the camera will shoot continuously in [P] mode, hold it steady while shooting.
- In [P] mode, excessive motion blur or certain shooting conditions may prevent you from obtaining the desired results.
- In [S] mode, mount the camera on a tripod or take other measures to keep it still and prevent camera shake. Additionally, you should set [IS Mode] to [Off] when using a tripod or other means to secure the camera (52).



- When you use a tripod for evening scenes, shooting in [AUTO] mode instead of [P] mode will give better results (34).
- You can also choose the shooting mode by accessing MENU (30) ▶ [1] tab ▶ [Rec. Mode].
- In [S] mode, although no frames are displayed when you press the shutter button halfway, optimal focus is still determined.

Before Use

Basic Guide

Advanced Guide

Camera Basics

Auto Mode / Hybrid Auto Mode

Other Shooting Modes

P Mode

Tv, Av, M, and C Mode

Playback Mode

Wi-Fi Functions

Setting Menu

Accessories

Appendix

Index



## Using Functions for Underwater Shots

### Shooting with an Underwater Focus Range

► Still Images ► Movies

If focusing is difficult in  $[i(k)]$  mode (📖55) with a focus range of  $[A]$ , using a focus range designed for underwater shooting can ensure optimal underwater shots.

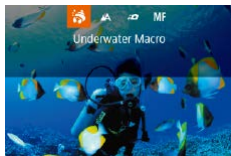

#### 1 Configure the setting.

- Follow steps 1 – 2 in “Specific Scenes” (📖55) and choose  $[i(k)]$ .
- Press the  $[<|>]$  button, choose the desired focus range (either press the  $[<|>]$  buttons or turn the  $[DIAL]$  dial), and then press the  $[OK]$  button.

#### 2 Shoot.

Focus range		Description
	Underwater Macro	Take close-ups of sea life, using the digital zoom for even closer shots.
	Quick	Avoid missing unexpected underwater shooting opportunities when shooting subjects some distance away. Especially effective for moving subjects.
	Manual Focus	Focus on subjects manually (📖87).

Refer to “Shooting Range” (📖219) for details on the range of each focus range.



- In  $[i(k)]$  mode, optical zoom is set to maximum wide angle.
- In  $[i(k)]$  mode, use of digital zoom may cause images to appear grainy at some recording pixel settings (📖97).
- In  $[i(k)]$  mode, subjects at close range may not be in focus. In this case, try setting the focus range to  $[A]$ .



- You can also configure this setting by pressing the  $[<|>]$  button, touching the desired focus range, and then touching it again.

### Correcting White Balance

► Still Images ► Movies

White balance can be manually corrected in  $[i(k)]$  mode (📖55). This adjustment can match the effect of using a commercially available color-compensating filter.



#### 1 Choose $[i(k)]$ .

- Follow steps 1 – 2 in “Specific Scenes” (📖55) and choose  $[i(k)]$ .

#### 2 Choose white balance.

- Press the  $[OK]$  button, and then choose  $[WB]$  in the menu.

#### 3 Adjust the setting.

- Turn the  $[DIAL]$  ring to adjust the correction level for B and A, and then press the  $[OK]$  button.
- Once the setting is complete,  $[WB]$  is displayed.

Before Use

Basic Guide

Advanced Guide

Camera Basics

Auto Mode /  
Hybrid Auto Mode

Other Shooting Modes

P Mode

Tv, Av, M, and C Mode

Playback Mode

Wi-Fi Functions

Setting Menu

Accessories

Appendix

Index





- B represents blue, and A represents amber.
- White balance can also be manually corrected by recording custom white balance data (📖83) before following the preceding steps.

## Applying Special Effects

Add a variety of effects to images when shooting.

### Shooting Yourself under Optimal Settings (Self Portrait)

For self-portraits, customizable image processing includes skin smoothing as well as brightness and background adjustment to make yourself stand out.

#### 1 Choose [👤].

- Follow steps 1 – 2 in “Specific Scenes” (📖55) and choose [👤].

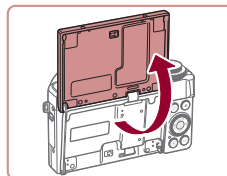

#### 2 Open the screen.

- Open the screen as shown.

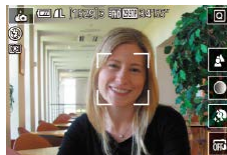

#### 3 Configure the setting.

- On the screen, touch the icon of the setting to configure.
- Choose the desired option.
- To return to the previous screen, touch [↩].



#### 4 Shoot.

Before Use

Basic Guide

Advanced Guide

Camera Basics

Auto Mode /  
Hybrid Auto Mode

Other Shooting Modes

P Mode

Tv, Av, M, and C Mode

Playback Mode

Wi-Fi Functions





Setting Menu

Accessories

Appendix

Index





Item	Details
	Choose from [AUTO] or one of six levels of background defocusing.
	Choose from five levels of brightness.
	Choose from five levels of skin smoothing. Skin smoothing is optimized for the main subject's face.
	To use Touch Shutter, choose [ON].



- Areas other than people's skin may be modified, depending on the shooting conditions.
- Try taking some test shots first to make sure you obtain the desired results.



- In  flash mode, background defocusing is set to [AUTO] and cannot be changed.
- In  mode, the time left before shooting is shown on the top of the screen when you activate the self-timer by selecting [ON], or by selecting [OFF] and setting the time to 3 seconds or more.

## Shooting Images with the Background Blurred to Convey a Sense of Speed (Panning)

► Still Images ► Movies

By panning, you can shoot blurred backgrounds that convey a sense of speed.

The camera will detect blurring of the subject and correct it, so you can reduce blurring of the subject.

### 1 Choose .

- Follow steps 1 – 2 in “Specific Scenes” (p.55) and choose .



### 2 Shoot.

- Before shooting, with the shutter button pressed halfway, move the camera so that it follows the subject.
- With the moving subject in the center of the screen, press the shutter button all the way down.
- Move the camera so that it continues to follow the subject even after you have pressed the shutter button all the way down.



- Try taking some test shots first, to make sure you obtain the desired results.



- To adjust the effect level, turn the  ring.
- When shooting, keep your arms close to your body and hold the camera with both hands steadily, and turn your whole body to follow subjects.
- The effect is more apparent when you follow subjects moving horizontally such as trains or cars.

Before Use

Basic Guide

Advanced Guide

Camera Basics

Auto Mode /  
Hybrid Auto Mode

Other Shooting Modes

P Mode

Tv, Av, M, and C Mode

Playback Mode

Wi-Fi Functions

Setting Menu

Accessories

Appendix

Index



## Shooting High-Contrast Scenes (High Dynamic Range)

► Still Images ► Movies

Three consecutive images are captured at different brightness levels each time you shoot, and the camera combines image areas with optimal brightness to create a single image. This mode can reduce the washed-out highlights and loss of detail in shadows that tend to occur in high-contrast shots.

### 1 Choose [HDR].

- Follow steps 1 – 2 in “Specific Scenes” (📖55) and choose [HDR].
- The subject appears slightly enlarged.

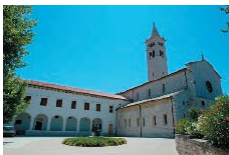

### 2 Shoot.

- Hold the camera steady as you shoot. When you press the shutter button all the way down, the camera will take three shots and combine them.



- Excessive motion blur or certain shooting conditions may prevent you from obtaining the desired results.



- If excessive camera shake interferes with shooting, mount the camera on a tripod or take other measures to keep it still. Additionally, you should set [IS Mode] to [Off] when using a tripod or other means to secure the camera (📖52).
- Any subject movement will cause images to look blurry.
- There will be a delay before you can shoot again, as the camera processes and combines the images.
- [ND] may be displayed when you press the shutter button halfway in bright conditions, indicating automatic adjustment for optimal image brightness.

## Adding Artistic Effects



- Follow steps 1 – 2 in “Specific Scenes” (📖55) and choose [HDR].
- Turn the (🔍) ring to choose an effect.
- A preview is shown of how your shot will look with the effect applied.

Natural	Images are natural and organic.
Art Standard	Images resemble paintings, with subdued contrast.
Art Vivid	Images resemble vivid illustrations.
Art Bold	Images resemble oil paintings, with bold edges.
Art Embossed	Images resemble old photos, with bold edges and dark ambiance.

## Shooting with a Fish-Eye Lens Effect (Fish-Eye Effect)

► Still Images ► Movies

Shoot with the distorting effect of a fish-eye lens.

### 1 Choose (🌀).

- Follow steps 1 – 2 in “Specific Scenes” (📖55) and choose (🌀).

### 2 Choose an effect level.

- Turn the (🔍) ring to choose an effect level.
- A preview is shown of how your shot will look with the effect applied.



### 3 Shoot.

Before Use

Basic Guide

Advanced Guide

Camera Basics

Auto Mode /  
Hybrid Auto Mode

Other Shooting Modes

P Mode

Tv, Av, M, and C Mode

Playback Mode

Wi-Fi Functions

Setting Menu

Accessories

Appendix

Index







- Try taking some test shots first, to make sure you obtain the desired results.

## Shots Resembling Oil Paintings (Art Bold Effect)

▶ Still Images ▶ Movies

Make subjects look more substantial, like subjects in oil paintings.

### 1 Choose [🔍].

- Follow steps 1 – 2 in “Specific Scenes” (📖55) and choose [🔍].

### 2 Choose an effect level.

- Turn the ([🔍]) ring to choose an effect level.
- A preview is shown of how your shot will look with the effect applied.

### 3 Shoot.



## Shots Resembling Watercolors (Water Painting Effect)

▶ Still Images ▶ Movies

Soften colors, for photos resembling watercolor paintings.

### 1 Choose [🔍].

- Follow steps 1 – 2 in “Specific Scenes” (📖55) and choose [🔍].

### 2 Choose an effect level.

- Turn the ([🔍]) ring to choose an effect level.
- A preview is shown of how your shot will look with the effect applied.

### 3 Shoot.



Before Use

Basic Guide

Advanced Guide

Camera Basics

Auto Mode /  
Hybrid Auto Mode

Other Shooting Modes

P Mode

Tv, Av, M, and C Mode

Playback Mode

Wi-Fi Functions

Setting Menu

Accessories

Appendix

Index



## Shots Resembling Miniature Models (Miniature Effect)

► Still Images ► Movies

Creates the effect of a miniature model, by blurring image areas above and below your selected area.

You can also make movies that look like scenes in miniature models by choosing the playback speed before the movie is recorded. People and objects in the scene will move quickly during playback. Note that sound is not recorded.

### 1 Choose [ ].

- Follow steps 1 – 2 in “Specific Scenes” (p.55) and choose [ ].
- A white frame is displayed, indicating the image area that will not be blurred.



### 2 Choose the area to keep in focus.

- Press the [ ] button.
- Move the zoom lever to resize the frame, and turn the [ ] dial to move it.



### 3 For movies, choose the movie playback speed.

- Turn the [ ] ring to choose the speed.

### 4 Return to the shooting screen and shoot.

- Press the [ ] button to return to the shooting screen, and then shoot.

## Playback Speed and Estimated Playback Time (for One-Minute Clips)

Speed	Playback Time
5x	Approx. 12 sec.
10x	Approx. 6 sec.
20x	Approx. 3 sec.

Movies are played back at 30 fps.



- The zoom is not available when recording movies. Be sure to set the zoom before shooting.
- Try taking some test shots first, to make sure you obtain the desired results.



- To switch the orientation of the frame to vertical, press the [ ] [ ] buttons in step 2. To return the frame to horizontal orientation, press the [ ] [ ] buttons.
- To move the frame when it is in horizontal orientation, press the [ ] [ ] buttons, and to move the frame when it is in vertical orientation, press the [ ] [ ] buttons.
- Holding the camera vertically will change the orientation of the frame.
- Movie image quality is [ ] at an aspect ratio of [4:3] and [ ] at an aspect ratio of [16:9] (p.49). These quality settings cannot be changed.



- You can also move the frame by touching or dragging across the screen.

Before Use

Basic Guide

Advanced Guide

Camera Basics

Auto Mode / Hybrid Auto Mode

Other Shooting Modes

P Mode

Tv, Av, M, and C Mode

Playback Mode

Wi-Fi Functions

Setting Menu

Accessories

Appendix

Index



## Shooting with a Toy Camera Effect (Toy Camera Effect)

▶ Still Images ▶ Movies

This effect makes images resemble shots from a toy camera by vignetting (darker, blurred image corners) and changing the overall color.

### 1 Choose [📷].

- Follow steps 1 – 2 in “Specific Scenes” (📖55) and choose [📷].



### 2 Choose a color tone.

- Turn the [🔘] ring to choose a color tone.
- A preview is shown of how your shot will look with the effect applied.

### 3 Shoot.

Standard	Shots resemble toy camera images.
Warm	Images have a warmer tone than with [Standard].
Cool	Images have a cooler tone than with [Standard].



- Try taking some test shots first, to make sure you obtain the desired results.

## Making Subjects Stand Out (Background Defocus)

▶ Still Images ▶ Movies

You can shoot subjects so that they stand out from the background. Two consecutive images are captured with settings optimized for background defocus. The background is defocused through lens effects and subject- and scene-based image processing.

### 1 Choose [👤].

- Follow steps 1 – 2 in “Specific Scenes” (📖55) and choose [👤].



### 2 Shoot.

- Hold the camera steady as you shoot. Two consecutive images are captured when you press the shutter button all the way down.
- A blinking [👤] icon indicates that the images could not be processed.



- Excessive motion blur or certain shooting conditions may prevent you from obtaining the desired results.



- For the best results with background defocusing, try shooting close to the subject, and ensure ample distance between the subject and background.
- There may be a delay after shooting before you can shoot again.
- To adjust the effect level, turn the [🔘] ring.

Before Use

Basic Guide

Advanced Guide

Camera Basics

Auto Mode / Hybrid Auto Mode

Other Shooting Modes

P Mode

Tv, Av, M, and C Mode

Playback Mode

Wi-Fi Functions

Setting Menu

Accessories

Appendix

Index



## Shooting with a Soft Focus Effect

▶ Still Images ▶ Movies

This function allows you to shoot images as if a soft focus filter were attached to the camera. You can adjust the effect level as desired.

### 1 Choose [👤].

- Follow steps 1 – 2 in “Specific Scenes” (📖55) and choose [👤].



### 2 Choose an effect level.

- Turn the [🔍] ring to choose an effect level.
- A preview is shown of how your shot will look with the effect applied.

### 3 Shoot.



- Try taking some test shots first, to make sure you obtain the desired results.

## Shooting in Monochrome (Grainy B/W)

▶ Still Images ▶ Movies

Take monochrome pictures with a gritty, rough feeling.

### 1 Choose [📖].

- Follow steps 1 – 2 in “Specific Scenes” (📖55) and choose [📖].

### 2 Choose an effect level.

- Turn the [🔍] ring to choose an effect level.
- A preview is shown of how your shot will look with the effect applied.



### 3 Shoot.

Before Use

Basic Guide

Advanced Guide

Camera Basics

Auto Mode /  
Hybrid Auto Mode

Other Shooting Modes

P Mode

Tv, Av, M, and C Mode

Playback Mode

Wi-Fi Functions

Setting Menu

Accessories

Appendix

Index



## Special Modes for Other Purposes

### Shooting Starry Skies (Star)

#### Shooting People against Starry Skies (Star Portrait)

► Still Images ► Movies

Capture beautiful shots of people against starry skies. After initially firing the flash to capture the person, the camera shoots twice without flash. The three images are combined into a single image and processed to make the stars more prominent.

For details on the flash range, see “Camera” (📖217).



#### 1 Choose [📷].

- Follow steps 1 – 2 in “Specific Scenes” (📖55) and choose [📷], and then press the [▲] button.
- Press the [◀][▶] buttons or turn the [🔍] dial to choose [📷], and then press the [📷] button.
- Zoom is set to maximum wide angle and cannot be adjusted.

#### 2 Raise the flash.

- Move the [⚡] switch to raise the flash.

#### 3 Secure the camera.

- Mount the camera on a tripod or take other measures to keep it still.

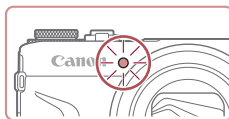
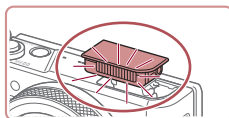

#### 4 Shoot.

- Press the shutter button. The flash fires as the camera takes the first shot.
- The second and third shots are now taken, without firing the flash.

#### 5 Have the person stay still until the lamp blinks.

- The person you are shooting should stay still until the lamp blinks three times after the third shot, which may take up to about two seconds.
- All the shots are combined to create a single image.



- Under some shooting conditions, images may not look as expected.
- For better shots, have the person stand away from illumination such as street lights, and make sure the flash is raised.
- There will be a delay before you can shoot again, as the camera processes the images.
- To avoid blurry shots, make sure the person you shoot in steps 4 – 5 stays still.

Before Use

Basic Guide

Advanced Guide

Camera Basics

Auto Mode /  
Hybrid Auto Mode

Other Shooting Modes

P Mode

Tv, Av, M, and C Mode

Playback Mode

Wi-Fi Functions

Setting Menu

Accessories

Appendix

Index





- For easier viewing, try choosing MENU ► [F2] tab ► [Night Display] ► [On] (172) before shooting.
- To adjust subject brightness, try changing the flash exposure compensation (96).
- To adjust background brightness, try changing the exposure compensation (78). However, images may not look as expected under some shooting conditions, and the person should stay still in steps 4 – 5, which may take up to about 15 seconds.
- To capture more stars and brighter starlight, choose MENU (30) ► [7] tab ► [Star Portrait Settings] ► [Star Visibility] ► [Prominent]. However, images may not look as expected under some shooting conditions, and the person should stay still in steps 4 – 5, which may take up to about 8 seconds.
- To make stars brighter, choose MENU (30) ► [7] tab ► [Star Emphasis] ► [Sharp]. To emphasize the bright stars in a starry sky, set [Star Emphasis] to [Soft]. This setting can produce eye-catching shots by enlarging bright stars while de-emphasizing dimmer stars. To disable starlight processing, select [Off].

## Shooting Night Scenes under Starry Skies (Star Nightscape)

► Still Images ► Movies

Capture impressive shots of starry skies above night scenes. Starlight in the image is automatically enhanced, making starry skies look beautiful.



### 1 Choose [7].

- Follow steps 1 – 2 in “Specific Scenes” (55) and choose [7], and then press the [▲] button.
- Press the [◀][▶] buttons or turn the [●] dial to choose [7], and then press the [SET] button.
- Zoom is set to maximum wide angle and cannot be adjusted.

### 2 Secure the camera.

- Mount the camera on a tripod or take other measures to keep it still and prevent camera shake.



### 3 Shoot.



- There will be a delay before you can shoot again, as the camera processes the images.

Before Use

Basic Guide

Advanced Guide

Camera Basics

Auto Mode / Hybrid Auto Mode

Other Shooting Modes

P Mode

Tv, Av, M, and C Mode

Playback Mode

Wi-Fi Functions

Setting Menu

Accessories

Appendix

Index





- For easier viewing, try choosing MENU ► [F2] tab ► [Night Display] ► [On] (172) before shooting.
- To make stars brighter, choose MENU (30) ► [5] tab ► [Star Emphasis] ► [Sharp]. To emphasize the bright stars in a starry sky, set [Star Emphasis] to [Soft]. This setting can produce eye-catching shots by enlarging bright stars while de-emphasizing dimmer stars. To disable starlight processing, select [Off].
- Try switching to manual focus mode (71, 87) to more accurately specify the focal position before shooting.

## Shooting Star Trails (Star Trails)

► Still Images ► Movies

Streaks created by the movement of stars through the sky are recorded in a single image. After determining the shutter speed and number of shots, the camera shoots continuously. A shooting session can last up to about two hours. Check the battery level in advance.



### 1 Choose [S].

- Follow steps 1 – 2 in “Specific Scenes” (55) and choose [S], and then press the [▲] button.
- Press the [◀][▶] buttons or turn the [DIAL] dial to choose [S], and then press the [S] button.
- Zoom is set to maximum wide angle and cannot be adjusted.

### 2 Specify the duration of the shooting session.

- Turn the [WHEEL] ring to choose the shooting duration.



### 3 Secure the camera.

- Mount the camera on a tripod or take other measures to keep it still.

### 4 Shoot.

- Press the shutter button all the way down. [Busy] is displayed briefly, and then shooting begins.
- Do not disturb the camera while shooting.
- To cancel shooting, press the shutter button all the way down again. Note that cancellation may take up to about 30 seconds.



- If the camera runs out of battery power, shooting stops and a composite image created from the images up to that point is saved.
- There will be a delay before you can shoot again, as the camera processes the images.



- For easier viewing, try choosing MENU ► [F2] tab ► [Night Display] ► [On] (172) before shooting.
- Try switching to manual focus mode (71, 87) to more accurately specify the focal position before shooting.

Before Use

Basic Guide

Advanced Guide

Camera Basics

Auto Mode / Hybrid Auto Mode

Other Shooting Modes

P Mode

Tv, Av, M, and C Mode

Playback Mode

Wi-Fi Functions

Setting Menu

Accessories

Appendix

Index



## Shooting Movies of Star Movement (Star Time-Lapse Movie)

▶ Still Images ▶ Movies

By recording a time-lapse movie that combines images shot at a specified interval, you can create movies with fast-moving stars. You can adjust the shooting interval and recording duration as needed.

Note that each session takes a long time, and requires many shots. Check the battery level and memory card space in advance.



### 1 Choose [Star Time-Lapse Movie].

- Follow steps 1 – 2 in “Specific Scenes” (110) and choose [Star Time-Lapse Movie], and then press the [SET] button.
- Press the [Left][Right] buttons or turn the [Dial] dial to choose [Star Time-Lapse Movie], and then press the [OK] button.
- Zoom is set to maximum wide angle and cannot be adjusted.

### 2 Configure movie settings.

- Press the [Right] button.
- Press the [Up][Down] buttons or turn the [Dial] dial to choose an item, and then choose the desired option.

### 3 Secure the camera.

- Mount the camera on a tripod or take other measures to keep it still.

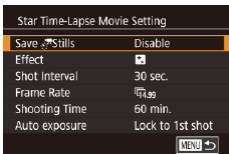

### 4 Check the brightness.

- Press the shutter button all the way down to shoot a single still image.
- Switch to Playback mode (110) and check image brightness.
- To adjust brightness, turn the exposure compensation dial and change the exposure level on the shooting screen. Check brightness again by taking another shot.

### 5 Shoot.

- Press the movie button. Recording begins, and the indicator on the back of the camera blinks.
- Do not disturb the camera while shooting.
- To cancel shooting, press the movie button again. Note that cancellation may take up to about 30 seconds.
- The camera operates in Eco mode (171) while shooting.

Before Use

Basic Guide

Advanced Guide

Camera Basics

Auto Mode / Hybrid Auto Mode

Other Shooting Modes

P Mode

Tv, Av, M, and C Mode

Playback Mode

Wi-Fi Functions

Setting Menu

Accessories

Appendix

Index





Item	Options	Details
Save  Stills	Enable/Disable	You can choose to save each shot collected before the movie is created. When [Enable] is selected, you cannot use [Effect].
Effect		Choose movie effects, such as star trails.
Shot Interval	15 sec., 30 sec., 1 min.	Choose the interval between each shot.
Frame Rate	,  (NTSC) ,  (PAL)	Choose the movie frame rate.
Shooting Time	60 min., 90 min., 120 min., Unlimited	Choose the length of the recording session. To record until the battery runs out, choose [Unlimited].
Auto exposure	Lock to 1st shot/ For each shot	You can choose to lock to the first shot's exposure or change the exposure for each shot.

Estimated playback time based on shooting interval and frame rate (for a one-hour session)

Interval between Shots	Frame Rate		Playback Time
	NTSC	PAL	
15 sec.			16 sec.
15 sec.			8 sec.
30 sec.			8 sec.
30 sec.			4 sec.
1 min.			4 sec.
1 min.			2 sec.



- There will be a delay before you can shoot again, as the camera processes the images.
- If the camera runs out of battery power or memory card space, shooting stops and a movie created from the images up to that point is saved.
- A shooting interval of [1 min.] is not available with these effects: , , , or .

Before Use

Basic Guide

Advanced Guide

Camera Basics

Auto Mode /  
Hybrid Auto Mode

Other Shooting Modes

P Mode

Tv, Av, M, and C Mode

Playback Mode

Wi-Fi Functions

Setting Menu

Accessories

Appendix

Index





- Sound is not recorded.
- For easier viewing, try choosing MENU ► [F2] tab ► [Night Display] ► [On] (📖172) before shooting.
- You can also access the screen in step 2 by choosing MENU (📖30) ► [C5] tab ► [Star Time-Lapse Movie Setting].
- Images saved with [Save Stills] set to [Enable] are managed as a single group, and during playback, only the first image is displayed. To indicate that the image is part of a group, [SET] is displayed in the upper left of the screen. If you erase a grouped image (📖123), all images in the group are also erased. Be careful when erasing images.
- Grouped images can be played back individually (📖117) and ungrouped (📖117).
- Protecting (📖121) a grouped image will protect all images in the group.
- Grouped images can be viewed individually when played back using Image Search (📖115). In this case, images are temporarily ungrouped.
- The following actions are not available for grouped images: editing Face ID information (📖118), magnifying (📖119), tagging as favorites (📖126), editing (📖128), printing (📖184), setting up individual image printing (📖188), or adding to a photobook (📖190). To do these things, either view grouped images individually (📖117) or cancel grouping (📖117) first.
- Try switching to manual focus mode (📖71, 📖87) to more accurately specify the focal position before shooting.

## Adjusting Colors

► Still Images ► Movies

Colors can be manually adjusted in [📷] mode.



### 1 Choose a shooting mode.

- Choose [📷] (📖65), [📷] (📖66), [📷] (📖67), or [📷] (📖68).

### 2 Choose color adjustment.

- Press the [📷] button, and then choose [WB] in the menu (📖29).

### 3 Adjust the setting.

- Turn the [🔘] ring or press the [◀|▶] buttons to adjust the correction level for B and A, and then press the [📷] button.
- Once the setting is complete, [WB] is displayed.



- B represents blue, and A represents amber.
- Skin tones remain the same when you adjust colors in [📷] mode.
- Advanced settings can be accessed by pressing the [MENU] button when the screen in step 2 is displayed (📖83).



- You can also choose the correction level by touching or dragging the bar in step 2.

Before Use

Basic Guide

Advanced Guide

Camera Basics

Auto Mode / Hybrid Auto Mode

Other Shooting Modes

P Mode

Tv, Av, M, and C Mode

Playback Mode

Wi-Fi Functions

Setting Menu

Accessories

Appendix

Index



## Adjusting the Focus

▶ Still Images ▶ Movies

Automatically adjust the focus to suit starry skies.

### 1 Choose a shooting mode.

- Choose [P] (p. 66), [A] (p. 67), or [S&L] (p. 68).

### 2 Secure the camera.

- Mount the camera on a tripod or take other measures to keep it still.

### 3 Frame the stars to capture.

- Press the [L/RF] button, choose [MF] (either press the [L/RF] buttons or turn the [MF] dial), and then press the [OK] button.
- Press the [FUNC./PUSH] button.
- Tilt the camera so that the stars to capture are inside the frame displayed.

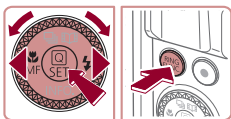

### 4 Adjust the focus.

- Press the [OK] button. [Adjusting star focus] is displayed, and adjustment begins.
- Adjustment may take about 20 seconds. Do not move the camera until [Adjustment completed] is displayed.
- Press the [OK] button.

### 5 Shoot (p. 66, p. 67, p. 68).



- The focus may not be adjusted under the following conditions. In this case, try again from step 3.
  - There is a bright light source
  - Airplanes or other light sources or clouds crossed the sky



- If adjustment fails, focus returns to the original position.

Before Use

Basic Guide

Advanced Guide

Camera Basics

Auto Mode /  
Hybrid Auto Mode

Other Shooting Modes

P Mode

Tv, Av, M, and C Mode

Playback Mode

Wi-Fi Functions

Setting Menu

Accessories

Appendix

Index



## Recording Various Movies

### Recording Movies in [M] Mode

▶ Still Images ▶ Movies

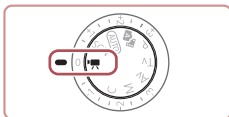

#### 1 Enter [M] mode.

- Set the mode dial to [M].
- Press the [MENU] button, choose [M] in the menu, and then choose [M] (729).
- Black bars are displayed on the top and bottom edges of the screen, and the subject is slightly enlarged. The black bars indicate image areas not recorded.

#### 2 Configure the settings to suit the movie (7200).

#### 3 Shoot.

- Press the movie button.
- To stop movie recording, press the movie button again.



- You can also choose the shooting mode by accessing MENU (730) ▶ [CAMERA] tab ▶ [Rec. Mode].



- Focus can be adjusted during recording by touching [AF] and pressing the [▲]/[▼] buttons while [MF] is displayed.

### Locking or Changing Image Brightness before recording

▶ Still Images ▶ Movies

You can lock the exposure before or during recording or adjust it in 1/3-stop increments within a range of -3 to +3 stops.



#### 1 Lock the exposure.

- Touch [X] to lock the exposure.
- To unlock the exposure, touch [X] again.

#### 2 Adjust the exposure.

- Turn the exposure compensation dial.

#### 3 Shoot (72).

Before Use

Basic Guide

Advanced Guide

Camera Basics

Auto Mode /  
Hybrid Auto Mode

Other Shooting Modes

P Mode

Tv, Av, M, and C Mode

Playback Mode

Wi-Fi Functions

Setting Menu

Accessories

Appendix

Index



## Disabling Auto Slow Shutter

▶ Still Images ▶ Movies

Auto slow shutter can be disabled if movement in movies is rough. However, under low light, movies may look dark.

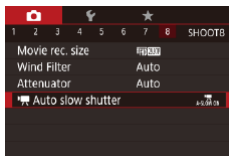

- Press the [MENU] button, choose [Auto slow shutter] on the [CAMERA] tab, and then choose [A-SLOW OFF] (📖30).
- To restore the original setting, repeat this process but choose [A-SLOW ON].



- Auto slow shutter is only available for [FHD 59.94P] and [FHD 50.00P] movies.

## Correcting Severe Camera Shake

▶ Still Images ▶ Movies

Counteract severe camera shake, such as when recording while moving. The portion of images displayed changes more than for [Standard], and subjects are further enlarged.

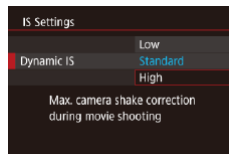

- Follow the steps in “Recording Movies with Subjects at the Same Size Shown before Shooting” (📖53) to choose [High].



- [Dynamic IS] is not available when [IS Mode] is set to [Off].
- Only [Standard] is available when the movie quality is [VGA 29.97P] (NTSC) or [VGA 25.00P] (PAL).

## Sound Settings

▶ Still Images ▶ Movies

### Deactivating the Wind Filter

Noise caused by strong wind can be reduced. However, the recording may sound unnatural when this option is used when there is no wind. In this case, you can deactivate the wind filter.

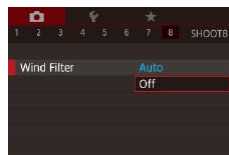

- Press the [MENU] button, choose [Wind Filter] on the [CAMERA] tab, and then press the [WIND] button (📖30).
- Choose [Off] (📖30).

Before Use

Basic Guide

Advanced Guide

Camera Basics

Auto Mode / Hybrid Auto Mode

Other Shooting Modes

P Mode

Tv, Av, M, and C Mode

Playback Mode

Wi-Fi Functions

Setting Menu

Accessories

Appendix

Index



## Using the Attenuator

The attenuator can reduce audio distortion in noisy environments. However, in quiet environments, it lowers the sound-recording level.

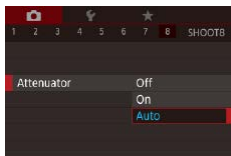

- Press the [MENU] button, choose [Attenuator] on the [INFO] tab, and then press the [OK] button (p.30).
- Choose an option as desired (p.30).

## Recording Short Clips

▶ Still Images ▶ Movies

Apply playback effects to brief clips of a few seconds, such as fast motion, slow motion, or replay. Clips recorded in this mode may be included in Story Highlights albums (p.136).

### 1 Enter [P] mode.

- Set the mode dial to [P].
- Press the [INFO] button, choose [P] in the menu, and then choose [P] (p.29).
- Black bars displayed on the top and bottom edges of the screen. They indicate that this image area cannot be recorded.



### 2 Specify the shooting time and playback effect.

- Press the [▶] button.
- Turn the [DISP] dial to set the shooting time (4 – 6 sec.), and press the [◀][▶] buttons to set the playback effect (p.74).

### 3 Shoot (p.72).

- A bar showing the elapsed time is displayed.

## Playback Effects

	Playback in fast motion
	Playback at normal speed
	Playback in slow motion
	Normal playback with the last two seconds rewound and played again in slow motion



- Sound is not recorded in these clips.
- The movie quality is [HD 29.97P] (for NTSC) or [HD 25.00P] (for PAL) (p.50, p.51) and cannot be changed.
- During [Replay] recording, a mark indicating the last two seconds is added to the bar showing the elapsed time.

## Shooting Time-Lapse Movies (Time-Lapse Movie)

▶ Still Images ▶ Movies

By recording a time-lapse movie that combines images shot at a specified interval, you can create a movie. You can view subject changes, such as landscape changes, in fast-forward. You can adjust the shooting interval and number of shots as needed.

### 1 Choose [S].

- Set the mode dial to [S].
- Press the [INFO] button, choose [S] in the menu, and then choose [S] (p.29).
- Black bars are displayed on the top and bottom edges of the screen. They indicate that this image area cannot be recorded.

Before Use

Basic Guide

Advanced Guide

Camera Basics

Auto Mode / Hybrid Auto Mode

Other Shooting Modes

P Mode

Tv, Av, M, and C Mode

Playback Mode

Wi-Fi Functions

Setting Menu

Accessories

Appendix

Index



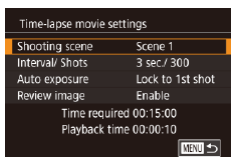

## 2 Configure movie settings.

- Press the [▶] button.
- Choose an item (either press the [▲][▼] buttons or turn the [DISK] dial), choose the desired option, and then press the [MENU] button.

## 3 Secure the camera.

- Mount the camera on a tripod or take other measures to keep it still.

## 4 Shoot.

- To start shooting, press the movie button.
- Do not disturb the camera while shooting.
- To cancel shooting, press the movie button again.
- The camera operates in Eco mode (📖171) while shooting.

Item	Details
Shooting scene	Choose from three types of scenes.
Interval/ Shots	Choose the number of shots per specified seconds.
Auto exposure	You can choose to lock to the first shot's exposure or change the exposure for each shot.
Review image	Play the movie immediately after it is shot for a maximum of 2 seconds.

Item	Details
Time required	Time required for shooting. The time varies depending on interval/shots. <ul style="list-style-type: none"> <li>- Scene 1: Maximum of 1 hour</li> <li>- Scene 2 and 3: Maximum of 2 hours</li> </ul>
Playback time	Playback time of the movie created from still images.



- If you shoot fast-moving subjects, they may look distorted.



- Sound is not recorded.
- Focal position during shooting remains constant, after it is determined for the first shot.
- The movie quality is [FHD] and cannot be changed.
- The frame rate of time-lapse movies varies depending on the video system (📖170) setting and cannot be changed: [29.97P] for NTSC and [25.00P] for PAL.
- You can also configure the settings by choosing MENU (📖30) ▶ [7] tab ▶ [Time-lapse movie settings].

Before Use

Basic Guide

Advanced Guide

Camera Basics

Auto Mode / Hybrid Auto Mode

Other Shooting Modes

P Mode

Tv, Av, M, and C Mode

Playback Mode

Wi-Fi Functions

Setting Menu

Accessories

Appendix

Index



## Recording iFrame Movies

▶ Still Images ▶ Movies

Record movies that can be edited with iFrame-compatible software or devices.



### 1 Choose [📹].

- Set the mode dial to [📹].
- Press the [📷] button, choose [📹] in the menu, and then choose [📹] (📖29).
- Black bars displayed on the top and bottom edges of the screen. They indicate that this image area cannot be recorded.

### 2 Shoot (📖72).



- iFrame is a video format developed by Apple Inc.
- The movie quality is [📹 29.97P] (for NTSC) or [📹 25.00P] (for PAL) (📖50, 📖51) and cannot be changed.

Before Use

Basic Guide

Advanced Guide

Camera Basics

Auto Mode /  
Hybrid Auto Mode

Other Shooting Modes

P Mode

Tv, Av, M, and C Mode

Playback Mode

Wi-Fi Functions

Setting Menu

Accessories

Appendix

Index





# P Mode

More discerning shots, in your preferred shooting style

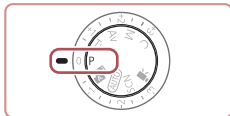

- Instructions in this chapter apply to the camera with the mode dial set to **[P]** mode.
- **[P]**: Program AE; AE: Auto Exposure
- Before using a function introduced in this chapter in modes other than **[P]**, make sure the function is available in that mode (📖200).

## Shooting in Program AE ([P] Mode)

▶ Still Images ▶ Movies

You can customize many function settings to suit your preferred shooting style.



### 1 Enter **[P]** mode.

- Set the mode dial to **[P]**.

### 2 Customize the settings as desired (📖78 – 📖99), and then shoot.



- If the optimum exposure cannot be obtained when you press the shutter button halfway, the shutter speed and aperture value are displayed in orange. In this case, try adjusting the ISO speed (📖80) or activating the flash (if subjects are dark, 📖95), which may enable optimum exposure.
- Movies can be recorded in **[P]** mode as well, by pressing the movie button. However, some **[Q]** menu (📖29) and MENU (📖30) settings may be automatically adjusted for movie recording.

Before Use

Basic Guide

Advanced Guide

Camera Basics

Auto Mode /  
Hybrid Auto Mode

Other Shooting Modes

**P Mode**

Tv, Av, M, and C Mode

Playback Mode

Wi-Fi Functions

Setting Menu

Accessories

Appendix

Index



## Image Brightness (Exposure)

### Adjusting Image Brightness (Exposure Compensation)

▶ Still Images ▶ Movies

The standard exposure set by the camera can be adjusted in 1/3-stop increments, in a range of -3 to +3.



- As you watch the screen, turn the exposure compensation dial to adjust brightness.

### Deactivating Expo. Simulation

Images are displayed on the screen at a brightness similar to the image that will be shot. Therefore, the screen brightness changes accordingly even when exposure compensation is in use. By not using this function, you can display images with brightness suitable for shooting regardless of changes in exposure compensation.

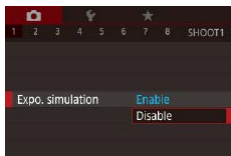

- Press the [MENU] button, and then choose the [CAM1] tab ▶ [Expo. simulation] ▶ [Disable] (30).

### Locking Image Brightness / Exposure (AE Lock)

▶ Still Images ▶ Movies

Before shooting, you can lock the exposure, or you can specify focus and exposure separately.

#### 1 Lock the exposure.

- Aim the camera at the subject to shoot with the exposure locked. With the shutter button pressed halfway, press the [RING FUNC.] button.
- [✳] is displayed, and the exposure is locked.
- To unlock the exposure, hold the shutter button halfway down and press the [RING FUNC.] button again. [✳] is no longer displayed.

#### 2 Compose the shot and shoot.



- AE: Auto Exposure
- After the exposure is locked, you can adjust the combination of shutter speed and aperture value by turning the [DISC] dial (Program Shift).



- You can also lock or unlock the exposure by touching [✳] in step 1.

Before Use

Basic Guide

Advanced Guide

Camera Basics

Auto Mode / Hybrid Auto Mode

Other Shooting Modes

P Mode

Tv, Av, M, and C Mode

Playback Mode

Wi-Fi Functions

Setting Menu

Accessories

Appendix

Index





## Changing the Metering Method

▶ Still Images ▶ Movies

Adjust the metering method (how brightness is measured) to suit shooting conditions as follows.



- Press the **[METERING]** button, choose **[METERING]** in the menu, and choose the desired option (📖29).
- The option you configured is now displayed.

 Evaluative metering	For typical shooting conditions, including backlit shots. Automatically adjusts exposure to match the shooting conditions.
 Spot metering	Metering restricted to within the <b>[ ]</b> (Spot AE Point frame). You can also link the Spot AE Point frame to the AF frame (📖79).
 Center-weighted average	Determines the average brightness of light across the entire image area, calculated by treating brightness in the central area as more important.

## Linking the Spot AE Point Frame to the AF Frame

▶ Still Images ▶ Movies

### 1 Set the metering method to **[ ]**.

- Follow the steps in “Changing the Metering Method” (📖79) to choose **[ ]**.

### 2 Configure the setting.

- Press the **[MENU]** button, choose [Spot AE Point] on the **[ ]** tab, and then choose [AF Point] (📖30).
- The Spot AE Point frame will now be linked to the movement of the AF frame (📖90).



- Not available when [AF method] is set to **[+Tracking]** (📖91).

Before Use

Basic Guide

Advanced Guide

Camera Basics

Auto Mode /  
Hybrid Auto Mode

Other Shooting Modes

P Mode

Tv, Av, M, and C Mode

Playback Mode

Wi-Fi Functions

Setting Menu

Accessories

Appendix

Index



## Changing the ISO Speed

▶ Still Images ▶ Movies

Set the ISO speed to [AUTO] for automatic adjustment to suit the shooting mode and conditions. Otherwise, set a higher ISO speed for higher sensitivity, or a lower value for lower sensitivity.



- Press the **[ISO]** button, choose **[ISO]** in the menu, and choose the desired option (📖29).
- The option you configured is now displayed.



- To view the automatically determined ISO speed when you have set the ISO speed to [AUTO], press the shutter button halfway.
- Although choosing a lower ISO speed may reduce image graininess, there may be a greater risk of subject and camera shake in some shooting conditions.
- The faster shutter speed used at higher ISO speeds reduces subject and camera shake and increases the flash range. However, shots may look grainy.
- You can also set the ISO speed by accessing MENU (📖30) ▶ **[C/5]** tab ▶ [ISO speed] ▶ [ISO Speed].

## Adjusting ISO Auto Settings

▶ Still Images ▶ Movies

When the camera is set to [AUTO], maximum ISO speed can be specified in a range of [400] – [12800], and sensitivity can be specified in a range of three levels.

### 1 Access the setting screen.

- Press the **[MENU]** button, choose [ISO speed] on the **[C/5]** tab, and then press the **[ISO]** button (📖30).
- Choose [ISO Auto Settings] and press the **[ISO]** button.

### 2 Configure the setting.

- Choose a menu item to configure, and then choose the desired option (📖30).

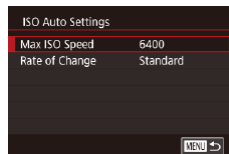

## Changing the Noise Reduction Level (High ISO Speed NR)

You can choose from 3 levels of noise reduction: [Low], [Standard], [High]. This function is especially effective when shooting at high ISO speeds.

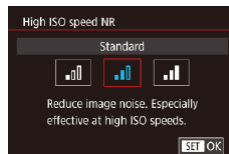

- Press the **[MENU]** button, choose [High ISO speed NR] on the **[C/6]** tab, and then choose the desired option (📖30).

Before Use

Basic Guide

Advanced Guide

Camera Basics

Auto Mode / Hybrid Auto Mode

Other Shooting Modes

P Mode

Tv, Av, M, and C Mode

Playback Mode

Wi-Fi Functions

Setting Menu

Accessories

Appendix

Index



## Auto Exposure Bracketing (AEB Shooting)

▶ Still Images ▶ Movies

Three consecutive images are captured at different exposure levels (standard exposure, underexposure, and then overexposure) each time you shoot. You can adjust the amount of underexposure and overexposure (relative to standard exposure) from -2 to +2 stops in 1/3-stop increments.

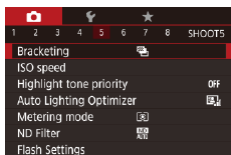

### 1 Choose [AEB].

- Press the [MENU] button, choose [Bracketing] on the [C/5] tab, and then choose [AEB] (📖30).

### 2 Configure the setting.

- Press the [Fn/C] button, and then adjust the setting by pressing the [4]/[1] buttons or turning the [DIAL] dial.

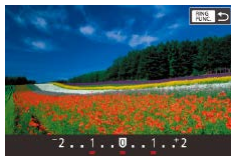

- AEB shooting is only available in [S/AF] mode (📖95).
- Continuous shooting (📖44) is not available in this mode.



- If exposure compensation is already in use (📖78), the value specified for that function is treated as the standard exposure level for this function.
- You can also access the setting screen of step 2 by pressing the [MENU] button when the exposure compensation screen (📖78) is displayed.
- Three shots are taken, regardless of any quantity specified in [C/5] (📖43).

## Adjusting Auto ND Filter Settings

For optimal brightness in the scenes you shoot, Auto ND filter reduces light intensity to 1/8 the actual level, by an amount equivalent to three stops. Choosing [ON] enables you to reduce the shutter speed and aperture value.

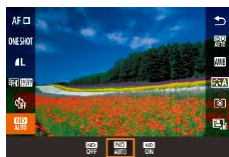

- Press the [Fn/C] button, choose [Auto ND] in the menu, and choose the desired option (📖29).
- The option you configured is now displayed.



- If you chose [ON], mount the camera on a tripod or take other measures to keep it still and prevent the camera from shaking. Additionally, you should set [IS Mode] to [Off] when using a tripod or other means to secure the camera (📖52).



- ND: Neutral Density

## Auto Correction of Brightness and Contrast (Auto Lighting Optimizer)

▶ Still Images ▶ Movies

Correct brightness and contrast automatically to avoid images that are too dark or lack contrast.

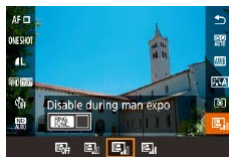

- Press the [Fn/C] button, choose [Auto Lighting Optimizer] in the menu, and choose the desired option (📖29).

Before Use

Basic Guide

Advanced Guide

Camera Basics

Auto Mode / Hybrid Auto Mode

Other Shooting Modes

P Mode

Tv, Av, M, and C Mode

Playback Mode

Wi-Fi Functions

Setting Menu

Accessories

Appendix

Index





- This feature may increase noise under some shooting conditions.
- When the effect of the Auto Lighting Optimizer is too strong and images become too bright, set it to [Low] or [Disable].
- Images may still be bright or the effect of exposure compensation may be weak under a setting other than [Disable] if you use a darker setting for exposure compensation or flash exposure compensation. For shots at your specified brightness, set this feature to [Disable].



- You can also configure this setting by choosing MENU (📖30) ► [C/5] tab ► [Auto Lighting Optimizer].

## Shooting Bright Subjects (Highlight Tone Priority)

► Still Images ► Movies

Improve gradation in bright image areas to avoid loss of detail in subject highlights.

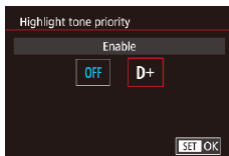

- Press the [MENU] button, choose [Highlight tone priority] on the [C/5] tab, and then choose [D+] (📖30).



- With [D+], ISO speeds of 250 or lower are not available. The Auto Lighting Optimizer is also disabled, in this case.

## Image Colors

### Capturing Natural Colors (White Balance)

► Still Images ► Movies

By adjusting white balance (WB), you can make image colors look more natural for the scene you are shooting.



- Press the [WB] button, choose [WB] in the menu, and choose the desired option (📖29).
- The option you configured is now displayed.

Auto	Automatically sets the optimal white balance for the shooting conditions.
Daylight	For shooting outdoors in fair weather.
Shade	For shooting in the shade.
Cloudy	For shooting in cloudy weather or at twilight.
Tungsten light	For shooting under ordinary incandescent lighting.
White fluorescent light	For shooting under white fluorescent lighting.
Flash	For shooting with the flash.
Underwater	For shooting underwater (📖57).
Custom	For manually setting a custom white balance (📖83).
Color temp.	For manually setting white balance color temperature (📖84).

Before Use

Basic Guide

Advanced Guide

Camera Basics

Auto Mode / Hybrid Auto Mode

Other Shooting Modes

P Mode

Tv, Av, M, and C Mode

Playback Mode

Wi-Fi Functions

Setting Menu

Accessories

Appendix

Index



## Custom White Balance

► Still Images ► Movies

For image colors that look natural under the light in your shot, adjust white balance to suit the light source where you are shooting. Set the white balance under the same light source that will illuminate your shot.

### 1 Shoot a white object.

- Aim the camera at a sheet of paper or other plain white subject, so that white fills the screen.
- Focus manually and shoot (📖87).

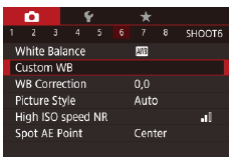

### 2 Choose [Custom WB].

- Choose [Custom WB] on the [📷6] tab, and then press the [SET] button.
- The custom white balance selection screen will appear.



### 3 Load the white data.

- Select your image from step 1, and then press the [SET] button.
- On the confirmation screen, press the [◀][▶] buttons to choose [OK], press the [SET] button, and then press the [SET] button again.
- Press the [MENU] button to close the menu.

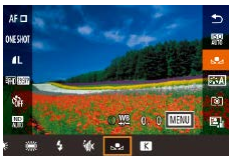

### 4 Choose [WB].

- Follow the steps in “Capturing Natural Colors (White Balance)” (📖82) to choose [WB].



- Shots in step 1 that are too bright or dark may prevent you from setting the white balance correctly.
- A message is displayed if you specify an image in step 3 that is not suitable for loading white data. Choose [Cancel] to choose a different image. Choose [OK] to use that image for loading white data, but note that it may not produce a suitable white balance.
- If [Unselectable image.] is displayed in step 3, choose [OK] to clear the message and specify another image.
- If [Set WB to “[WB]”] is displayed in step 3, press the [SET] button to return to the menu screen, and then choose [WB].



- Instead of a white object, a gray chart or 18 % gray reflector (commercially available) can produce a more accurate white balance.
- The current white balance and related settings are disregarded when you shoot in step 1.

## Manually Correcting White Balance

► Still Images ► Movies

You can correct white balance. This adjustment can match the effect of using a commercially available color temperature conversion filter or color-compensating filter.



### 1 Configure the setting.

- Follow the steps in “Capturing Natural Colors (White Balance)” (📖82) to choose [WB].
- Turn the [WB] ring to adjust the correction level for B and A.

Before Use

Basic Guide

Advanced Guide

Camera Basics

Auto Mode /  
Hybrid Auto Mode

Other Shooting Modes

P Mode

Tv, Av, M, and C Mode

Playback Mode

Wi-Fi Functions

Setting Menu

Accessories

Appendix

Index



## 2 Configure advanced settings.

- To configure more advanced settings, press the [MENU] button and adjust the correction level by turning the [Q] ring or the [WB] dial or pressing the [▲][▼][◀][▶] buttons.
- To reset the correction level, press the [FUNC.] button.
- Press the [OK] button to complete the setting.
- Once the setting is complete, [WB] is displayed.



- Any correction level you set is retained even if you change the white balance option in step 1.



- B: blue; A: amber; M: magenta; G: green
- You can customize camera operation so that the B and A adjustment screen is accessed simply by turning the [Q] ring or the [WB] dial (104).
- One level of blue/amber correction is equivalent to about 5 mireds on a color temperature conversion filter. (Mired: Color temperature unit representing color temperature conversion filter density)
- You can also configure this setting by choosing MENU (30) ▶ [CAMERA] tab ▶ [WB Correction].



- You can also choose the correction level by touching or dragging the bar in step 1 or the frame in step 2.

## Configuring White Balance Color Temperature

▶ Still Images ▶ Movies

You can specify a value to configure the white balance color temperature.



- Follow the procedure in “Capturing Natural Colors (White Balance)” (82) to choose [K].
- Press the [FUNC.] button, and then adjust the setting by pressing the [◀][▶] buttons or turning the [WB] dial.



- You can also configure the white balance color temperature by choosing MENU (30) ▶ [CAMERA] tab ▶ [White Balance] ▶ [K].
- Color temperature can be set in a range of approximately 2,500 to 10,000 K (in 100 K increments).

## Customizing Colors (Picture Style)

▶ Still Images ▶ Movies

You can choose your preferred colors as a Picture Style to suit the picture representation and subjects. Eight Picture Styles are available, and each can be further customized.



- Press the [OK] button, choose [Picture Style] in the menu, and choose the desired option (29).

Before Use

Basic Guide

Advanced Guide

Camera Basics

Auto Mode / Hybrid Auto Mode

Other Shooting Modes

P Mode

Tv, Av, M, and C Mode

Playback Mode

Wi-Fi Functions

Setting Menu









Accessories

Appendix





Index











 Auto	Automatically adjusts colors to suit the shooting conditions. Makes pictures of blue skies, greenery, and sunset colors more vivid in scenes of nature, outdoor, and sunsets.
 Standard	Makes pictures more vivid and sharper. Generally, this setting can be used for most scenes.
 Portrait	Makes pictures slightly sharper, with clear skin tone. Ideal for close-ups of people. You can adjust skin tone by changing [Color tone] (85).
 Landscape	Makes pictures much sharper with more vivid blue skies and greenery. Ideal for impressive landscape shots.
 Fine Detail	Used for rendering sharper edges and intricate textures. Makes pictures slightly more vivid.
 Neutral	Used for images to be processed on a computer. Makes pictures natural-colored with a subdued appearance.
 Faithful	Used for images assumed to be processed on a computer. Faithfully reproduces the actual colors of subjects as measured under daylight with a color temperature of 5200 K. Makes pictures have a toned-down color with a subdued appearance.
 Monochrome	Creates black and white pictures.
 User Def.	You can register basic styles, such as [Portrait], [Landscape], and Picture Style files, and customize them (84).



- Default [Auto] settings are used for , , and  until you add a Picture Style.
- You can also configure this setting by accessing MENU (30) ►  tab ► [Picture Style].

## Customizing Picture Styles

You can customize the following settings.

Sharpness	 Strength	Adjusts edge enhancement level. For softer (more blurry) images, set a lower value, and for harder (sharper) images, set a higher value.
	 Fineness	Indicates the edge thinness that sharpness enhancement applies to. For more enhanced details, set a lower value.
	 Threshold	Specifies how much difference in contrast between edges and surrounding areas there should be to enhance edges. To enhance edges with smaller contrast difference, set a lower value. Note that if you set a lower value, noise may be emphasized.
 Contrast		Adjusts contrast. For lower contrast, set a lower value, and for higher contrast, set a higher value.
 Saturation* <sup>1</sup>		Adjusts color saturation. For less intense colors, set a lower value, and for more intense colors, set a higher value.
 Color tone* <sup>1</sup>		Adjusts skin tone. For more red tone, set a lower value, and for more yellow tone, set a higher value.

Before Use

Basic Guide

Advanced Guide

Camera Basics

Auto Mode /  
Hybrid Auto Mode

Other Shooting Modes

P Mode

Tv, Av, M, and C Mode

Playback Mode

Wi-Fi Functions



Setting Menu

Accessories

Appendix

Index



 Filter effect**2	<p>Emphasizes white clouds and green trees in monochrome images.</p> <p>N: Normal monochrome images with no filter effect.</p> <p>Ye: Blue skies look more natural and white clouds stand out better.</p> <p>Or: Blue skies look slightly darker. Glow of sunsets is emphasized.</p> <p>R: Blue skies look much darker. Colored leaves look clearly brighter.</p> <p>G: Skin tones and lips of people look muted. Green leaves of trees look clearly brighter.</p>
 Toning effect**2	<p>Available monochrome colors: [N:None], [S:Sepia], [B:Blue], [P:Purple], or [G:Green].</p>

\*1 Not available with .

\*2 Only available with .









• [Fineness] and [Threshold] of [Sharpness] are not applied to movies.

### 1 Access the setting screen.

- Follow the procedure in “Customizing Colors (Picture Style)” (p.84) to choose the required Picture Style.
- Press the  button.

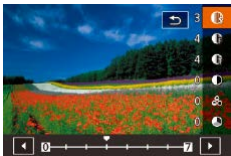

### 2 Configure the setting.

- Press the  buttons to configure the level of effect, and then choose an option, either by pressing the  buttons or turning the  dial.
- To reset the changes, press the .
- When finished, press the .







- If you set higher [Contrast], [Filter effect] is more emphasized.



## Registering Customized Picture Styles

You can customize basic styles, such as  and , and register them. You can prepare several styles with different sharpness and contrast settings.

### 1 Choose a destination Picture Style.







- Follow the procedure in “Customizing Colors (Picture Style)” (p.84) to choose , , or .
- Press the  button.

### 2 Choose a preset Picture Style.

- Press the  buttons or turn the  dial to choose a preset Picture Style.



### 3 Customize the Picture Style.

- Press the  buttons to choose an item to modify, and then adjust the setting, either by pressing the  buttons or turning the  dial.
- When finished, press the .



- You can register the Picture Style with the camera using the software CameraWindow (p.182). For registering to the camera, refer to CameraWindow Help.



- You can also choose a preset Picture Style by touching  in step 1.

Before Use

Basic Guide

Advanced Guide

Camera Basics

Auto Mode / Hybrid Auto Mode

Other Shooting Modes

P Mode

Tv, Av, M, and C Mode

Playback Mode

Wi-Fi Functions

Setting Menu

Accessories

Appendix

Index



## Shooting Range and Focusing

### Shooting Close-Ups (Macro)

▶ Still Images ▶ Movies

To restrict the focus to subjects at close range, set the camera to [M]. For details on the range of focus, see “Shooting Range” (p.219).

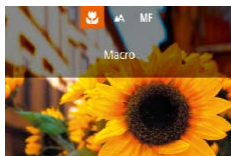

- Press the [◀] button, choose [M] (either press the [◀][▶] buttons or turn the [DIAL]), and then press the [SET] button.
- Once the setting is complete, [M] is displayed.



- If the flash fires, vignetting may occur.



- To prevent camera shake, try mounting the camera on a tripod and shooting with the camera set to [C] (p.43).



- You can also configure this setting by pressing the [◀] button, touching [M], and then touching it again.

### Shooting in Manual Focus Mode

▶ Still Images ▶ Movies

When focusing is not possible in AF mode, use manual focus. You can specify the general focal position and then press the shutter button halfway to have the camera determine the optimal focal position near the position you specified. For details on the range of focus, see “Shooting Range” (p.219).

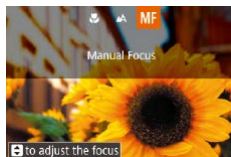

(1)

#### 1 Choose [MF].

- Press the [◀] button, choose [MF] (either press the [◀][▶] buttons or turn the [DIAL]), and then press the [SET] button.
- [MF] and the MF indicator are displayed.

#### 2 Specify the general focal position.

- Referring to the on-screen MF indicator (1, which shows the distance and focal position) and the magnified display, turn the [DIAL] to specify the general focal position, and then press the [SET] button.
- You can adjust the magnification by pressing the [▶] button during magnified display.
- You can move the focusing frame by dragging on the magnified display screen.

#### 3 Fine-tune the focus.

- Press the shutter button halfway or touch [AF] to fine-tune the focal position (Safety MF).
- To cancel manual focus, choose [A] in step 1.

Before Use

Basic Guide

Advanced Guide

Camera Basics

Auto Mode / Hybrid Auto Mode

Other Shooting Modes

P Mode

Tv, Av, M, and C Mode

Playback Mode

Wi-Fi Functions

Setting Menu

Accessories

Appendix

Index





- When you focus manually, the AF method (📖89) is [1-point AF] and AF frame size (📖90) is [Normal], and these settings cannot be changed.
- Focusing is possible when using the digital zoom (📖41) or digital tele-converter (📖89), or when using a TV as a display (📖179), but the magnified display will not appear.



- To focus more accurately, try attaching the camera to a tripod to stabilize it.
- You can enlarge or hide the magnified display area by adjusting MENU (📖30) ▶ [📷4] tab ▶ [MF-Point Zoom] settings.
- To deactivate automatic focus fine-tuning when the shutter button is pressed halfway, choose MENU (📖30) ▶ [📷4] tab ▶ [Safety MF] ▶ [Off].



- You can lock the focus during movie recording by touching [AF]. [MF] is then displayed.

## Easily Identifying the Focus Area (MF Peaking)

▶ Still Images ▶ Movies

Edges of subjects in focus are displayed in color to make manual focusing easier. You can adjust the colors and the sensitivity (level) of edge detection as needed.

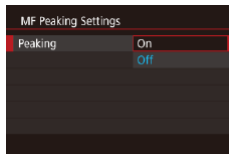

### 1 Access the setting screen.

- Press the [MENU] button, choose [MF Peaking Settings] on the [📷4] tab, choose [Peaking], and then choose [On] (📖30).

### 2 Configure the setting.

- Choose a menu item to configure, and then choose the desired option (📖30).



- Colors displayed for MF peaking are not recorded in your shots.

## Focus Bracketing (Focus-BKT Mode)

▶ Still Images ▶ Movies

Three consecutive images are captured each time you shoot, with the first one at the focal distance you set manually and the others at farther and nearer focal positions determined by presets. The distance from your specified focus can be set in three levels.

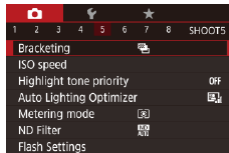

### 1 Choose [📷5].

- Press the [MENU] button, choose [Bracketing] on the [📷5] tab, and then choose [📷5] (📖30).

Before Use

Basic Guide

Advanced Guide

Camera Basics

Auto Mode / Hybrid Auto Mode

Other Shooting Modes

P Mode

Tv, Av, M, and C Mode

Playback Mode

Wi-Fi Functions

Setting Menu

Accessories

Appendix

Index



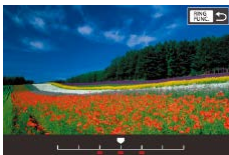

## 2 Configure the setting.

- Press the **[MENU]** button, and then adjust the setting by pressing the **[◀]**/**[▶]** buttons or turning the **[DISP.]** dial.



- Focus bracketing is only available in **[AF-ON]** mode (895).
- Continuous shooting (44) is not available in this mode.



- You can also access the setting screen in step 2 by pressing the **[MENU]** button in step 2 of "Shooting in Manual Focus Mode" (87).
- Three shots are taken, regardless of any quantity specified in (43).



- You can also configure this setting by touching or dragging the bar on the screen in step 2 to specify a value and then touching **[MENU]**.

## Digital Tele-Converter

▶ Still Images ▶ Movies

The focal length of the lens can be increased by approximately 1.6x or 2.0x. This can reduce camera shake because the shutter speed is faster than it would be if you zoomed (including using digital zoom) in to the same zoom factor.

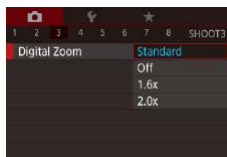

- Press the **[MENU]** button, choose **[Digital Zoom]** on the **[CAM3]** tab, and then choose the desired option (30).
- The view is enlarged and the zoom factor is displayed on the screen.



- The shutter speed may be equivalent when you move the zoom lever all the way toward **[TL]** for maximum telephoto, and when you zoom in to enlarge the subject to the same size following step 2 in "Zooming In Closer on Subjects (Digital Zoom)" (41).

## Choosing the AF Method

▶ Still Images ▶ Movies

Change the auto focus (AF) mode to suit shooting conditions.



- Press the **[DISP.]** button, choose **[AF]** in the menu, and choose the desired option (30).



- You can also configure this setting by accessing **MENU** (30) ▶ **[CAM3]** tab ▶ **[AF method]**.

Before Use

Basic Guide

Advanced Guide

Camera Basics

Auto Mode /  
Hybrid Auto Mode

Other Shooting Modes

P Mode

Tv, Av, M, and C Mode

Playback Mode

Wi-Fi Functions

Setting Menu

Accessories

Appendix

Index



## 1-point AF

▶ Still Images ▶ Movies

The camera focuses using a single AF frame. Effective for reliable focusing. You can also move the frame by touching the screen (📖93).



- A yellow AF frame is displayed with [AF-ON] if the camera cannot focus when you press the shutter button halfway.



- To compose shots so that subjects are positioned at the edge or in a corner, first aim the camera to capture the subject in an AF frame, and then hold the shutter button halfway down. As you continue to hold the shutter button halfway, recompose the shot as desired, and then press the shutter button all the way down (Focus Lock).

## Moving and Resizing AF Frames (1-point AF)

▶ Still Images ▶ Movies

When you want to change the position or size of the AF frame, set the AF method to [1-point AF].



### 1 Move the AF frame.

- Touch the screen. An AF frame is displayed in orange where you touched (Touch AF).
- Turn the [AF-ON] dial to move the AF frame, and press the [▲][▼][◀][▶] buttons to fine-tune the position.
- To return the AF frame to the original position in the center, press the [MENU] button.

### 2 Resize the AF frame.

- To reduce the AF frame size, turn the [AF-ON] ring. Turn it again to restore it to the original size.

### 3 Finish the setup process.

- Press the [OK] button.



- AF frames are displayed at normal size when you use the digital zoom (📖41) or digital tele-converter (📖89), and in manual focus mode (📖87).



- You can also link the Spot AE Point frame to the AF frame (📖79).
- You can also configure the AF frame size by pressing the [MENU] button and choosing [AF Frame Size] on the [CAMERA] tab (📖30).

Before Use

Basic Guide

Advanced Guide

Camera Basics

Auto Mode /  
Hybrid Auto Mode

Other Shooting Modes

P Mode

Tv, Av, M, and C Mode

Playback Mode

Wi-Fi Functions

Setting Menu

Accessories

Appendix

Index



- Detects people's faces, and then sets the focus, exposure (evaluative metering only), and white balance ([MWB] only).
- After you aim the camera at the subject, a white frame is displayed around the person's face determined by the camera to be the main subject, and up to two gray frames are displayed around other detected faces.
- When the camera detects movement, frames will follow moving subjects, within a certain range.
- After you press the shutter button halfway, up to nine green frames are displayed around faces in focus.



- When no faces are detected, or when only gray frames are displayed (without a white frame), pressing the shutter button halfway will display green frames in the areas in focus. Note that the maximum number of frames depends on the aspect ratio ([A49] setting).
- If no faces are detected in Servo AF ([M91] mode), the AF frame is displayed in the center of the screen when you press the shutter button halfway.
- Examples of faces that cannot be detected:
  - Subjects that are distant or extremely close
  - Subjects that are dark or light
  - Faces in profile, at an angle, or partly hidden
- The camera may misinterpret non-human subjects as faces.
- No AF frames are displayed if the camera cannot focus when you press the shutter button halfway.

## Shooting with Servo AF

This mode helps avoid missing shots of subjects in motion, because the camera continues to focus on the subject and adjust the exposure as long as you press the shutter button halfway.

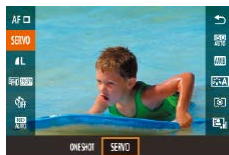

### 1 Configure the setting.

- Press the [M] button, choose [ONE SHOT] in the menu, and then choose [SERVO] ([M30]).

### 2 Focus.

- The focus and exposure are maintained where the blue AF frame is displayed while you are pressing the shutter button halfway.



- Focusing may not be possible in some shooting conditions.
- In low-light conditions, Servo AF may not be activated (AF frames may not turn blue) when you press the shutter button halfway. In this case, the focus and exposure are set according to the specified AF method.
- Continuous shooting ([M44]) is slower in Servo AF mode.
- If optimum exposure cannot be obtained, the shutter speed and aperture value are displayed in orange. Release the shutter button, and then press it halfway again.
- AF lock shooting ([M94]) is not available.
- Not available when using the self-timer ([M42]).



- To have the camera keep adjusting the focus during continuous shooting ([M44]), specify Servo AF with [AF method] set to [1-point AF].
- You can also configure this setting by accessing MENU ([M30]) ▶ [M3] tab ▶ [AF operation].



## Changing the Focus Setting

▶ Still Images ▶ Movies

You can change default camera operation of constantly focusing on subjects it is aimed at, even when the shutter button is not pressed. Instead, you can limit camera focusing to the moment you press the shutter button halfway.

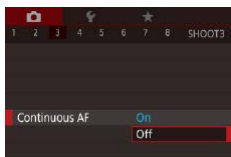

- Press the [MENU] button, choose [Continuous AF] on the [CAMERA] tab, and then choose [Off] (p.30).

On	Helps avoid missing sudden photo opportunities, because the camera constantly focuses on subjects until you press the shutter button halfway.
Off	Conserves battery power, because the camera does not focus constantly.

## Fine-Tuning the Focus

▶ Still Images ▶ Movies

You can fine-tune after auto focus using the control ring.



### 1 Configure the setting.

- Press the [MENU] button, choose [AF+MF] on the [CAMERA] tab, and then choose [On] (p.30).

### 2 Focus.

- Press the shutter button halfway to focus on the subject, and continue holding the button halfway down.

### 3 Fine-tune the focus.

- Referring to the on-screen MF indicator (which shows the distance and focal position) that is displayed by turning the [L] ring and the magnified display, turn the [R] ring to adjust the focus.
- To change the zoom factor of the magnified display, press the [Z] button.
- To cancel focusing, release the shutter button.

### 4 Shoot.

- Press the shutter button all the way down to shoot.



- Cannot be used with Servo AF (p.91).

Before Use

Basic Guide

Advanced Guide

Camera Basics

Auto Mode / Hybrid Auto Mode

Other Shooting Modes

P Mode

Tv, Av, M, and C Mode

Playback Mode

Wi-Fi Functions

Setting Menu

Accessories

Appendix

Index





## Choosing a Person to Focus On (Face Select)

▶ Still Images ▶ Movies

You can shoot after choosing a specific person's face to focus on.

**1** Set the AF method to [L+Tracking] (89).

**2** Assign [Fn] to the [Fn] button or the movie button (106).



**3** Enter Face Select mode.

- Aim the camera at the person's face and press the [Fn] button or the movie button.
- After [Face Select : On] is displayed, a face frame [ ] is displayed around the face detected as the main subject.
- Even if the subject moves, the face frame [ ] follows the subject within a certain range.
- If a face is not detected, [ ] is not displayed.

**4** Choose the face to focus on.

- To switch the face frame [ ] to another detected face, press the [Fn] button or the movie button.
- Once you cycle through all detected faces, [Face Select : Off] is displayed, followed by the selected AF method screen.



**5** Shoot.

- Press the shutter button halfway. After the camera focuses, [ ] changes to [ ].
- Press the shutter button all the way down to shoot.



- When [Face ID] is set to [On], only the name of the registered person chosen as the main subject is displayed, even if other registered people have been detected. However, their names will be recorded in the still images (45).

## Choosing Subjects to Focus On (Touch AF)

▶ Still Images ▶ Movies

You can shoot after choosing a person's face or another subject to focus on.



**1** Set the AF method to [L+Tracking] (89).

**2** Choose a person's face or another subject to focus on.

- Touch the subject or person on the screen.
- When the subject is detected, the camera beeps and [ ] is displayed. Focus is maintained even if the subject moves.
- To cancel Touch AF, touch [ ].

Before Use

Basic Guide

Advanced Guide

Camera Basics

Auto Mode /  
Hybrid Auto Mode

Other Shooting Modes

P Mode

Tv, Av, M, and C Mode

Playback Mode

Wi-Fi Functions

Setting Menu

Accessories



Appendix

Index







### 3 Shoot.

- Press the shutter button halfway. After the camera focuses,  changes to a green .
- Press the shutter button all the way down to shoot.





- If you prefer the camera not to shoot when you touch the screen, make sure [Touch Shutter] mode is deactivated. Press the [MENU] button, choose [Touch Shutter] on the  tab, and then choose [Disable] (📖30).
- Tracking may not be possible when subjects are too small or move too rapidly, or when there is inadequate contrast between subjects and the background.
- Even if you are shooting in  mode (📖87), the camera will revert to  mode if you touch the screen to specify where to focus.
- If [Face ID] is set to [On], names will not be displayed when registered people are detected, but the names will be recorded in the still images (📖45). However, a name will be displayed if the subject chosen to focus on is the same as a person detected with Face ID.

## Shooting with the AF Lock

▶ Still Images ▶ Movies

The focus can be locked. After you lock the focus, the focal position will not change even when you release your finger from the shutter button.

### 1 Lock the focus.

- With the shutter button pressed halfway, press the  button.
- The focus is now locked, and [MF] and the MF indicator are displayed.
- To unlock the focus, hold the shutter button halfway down and press the  button again.

### 2 Compose the shot and shoot.



- Cannot be used with Touch Shutter (📖44).



- When [AF method] is set to [1-point AF], you can lock the focus by touching the screen during movie recording. To unlock the focus, touch .

Before Use

Basic Guide

Advanced Guide

Camera Basics

Auto Mode /  
Hybrid Auto Mode

Other Shooting Modes

P Mode

Tv, Av, M, and C Mode

Playback Mode

Wi-Fi Functions

Setting Menu

Accessories

Appendix

Index



# Flash

## Changing the Flash Mode

▶ Still Images ▶ Movies

You can change the flash mode to match the shooting scene. For details on the flash range, see “Camera” (p.217).

### 1 Raise the flash.

- Move the [Flash] switch.

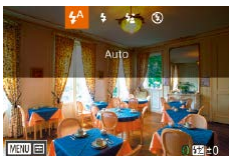

### 2 Configure the setting.

- Press the [Right Arrow] button, choose a flash mode (either press the [Left Arrow][Right Arrow] buttons or turn the [Dial], and then press the [OK] button).
- The option you configured is now displayed.



- The setting screen cannot be accessed by pressing the [Right Arrow] button when the flash is lowered. Move the [Flash] switch to raise the flash, then configure the setting.
- If the flash fires, vignetting may occur.



- You can also configure this setting by pressing the [Right Arrow] button, touching the desired option, and then touching it again.

## Auto

Fires automatically in low-light conditions.

## On

Fires for each shot.

## Slow Synchro

Fires to illuminate the main subject (such as people) while shooting at a slower shutter speed to illuminate backgrounds out of flash range.



- In [Flash] mode, mount the camera on a tripod or take other measures to keep it still and prevent camera shake. Additionally, you should set [IS Mode] to [Off] when using a tripod or other means to secure the camera (p.52).
- In [Flash] mode, even after the flash fires, ensure that the main subject does not move until the shutter sound is finished playing.

## Off

For shooting without the flash.



- A blinking [Flash] icon may be displayed when you press the shutter button halfway in camera-shake inducing, low-light conditions. In this case, mount the camera on a tripod or take other measures to keep it still.

Before Use

Basic Guide

Advanced Guide

Camera Basics

Auto Mode /  
Hybrid Auto Mode

Other Shooting Modes

P Mode

Tv, Av, M, and C Mode

Playback Mode

Wi-Fi Functions

Setting Menu

Accessories

Appendix

Index



## Adjusting the Flash Exposure Compensation

▶ Still Images ▶ Movies

Just as with regular exposure compensation (📖78), you can adjust the flash exposure from -2 to +2 stops, in 1/3-stop increments.

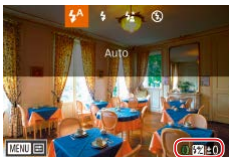

- Raise the flash, press the [▶] button and immediately turn the [🔘] ring to choose the compensation level, and press the [🔘] button.
- The correction level you specified is now displayed.



- When there is a risk of overexposure, the camera automatically adjusts the shutter speed or aperture value for flash shots to reduce washed-out highlights and shoot at optimal exposure. However, you can deactivate automatic adjustment of the shutter speed and aperture value by accessing MENU (📖30) and choosing [📷5] tab ▶ [Flash Settings] ▶ [Safety FE] ▶ [Off].
- You can also configure the flash exposure compensation by accessing MENU (📖30) and choosing [📷5] tab ▶ [Flash Settings] ▶ [Flash Exp. Comp].
- You can also access the [Flash Settings] screen (📖30) when the flash is up by pressing the [▶] button and immediately pressing the [MENU] button.



- You can also access the [Flash Settings] screen (📖30) by pressing the [▶] button and touching [MENU].

## Shooting with the FE Lock

▶ Still Images ▶ Movies

Just as with the AE lock (📖78), you can lock the exposure for flash shots.

### 1 Raise the flash and set it to [🔘] (📖95).

### 2 Lock the flash exposure.

- Aim the camera at the subject to shoot with the exposure locked. With the shutter button pressed halfway, press the [RING FUNC.] button.
- The flash fires, and when [✳] is displayed, the flash output level is retained.
- To unlock FE, press the [RING FUNC.] button again with the shutter button pressed halfway. In this case, [✳] is no longer displayed.



### 3 Compose the shot and shoot.



- FE: Flash Exposure



- You can also lock or unlock the exposure by touching [✳] on the setting screen in step 2.

Before Use

Basic Guide

Advanced Guide

Camera Basics

Auto Mode /  
Hybrid Auto Mode

Other Shooting Modes

P Mode

Tv, Av, M, and C Mode

Playback Mode

Wi-Fi Functions

Setting Menu

Accessories

Appendix

Index



## Changing the Flash Timing

► Still Images ► Movies

Change the timing of the flash and shutter release as follows.

### 1 Access the setting screen.

- Press the [MENU] button, choose [Flash Settings] on the [CAMERA] tab, and then press the [INFO] button (p.30).

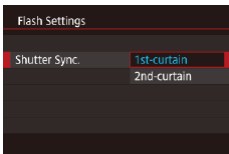

### 2 Configure the setting.

- Choose [Shutter Sync.], and then choose the desired option (p.30).

1st-curtain	The flash fires immediately after the shutter opens.
2nd-curtain	The flash fires immediately before the shutter closes.

## Other Settings

### Changing Image Quality

► Still Images ► Movies

Choose from 7 combinations of size (number of pixels) and compression (image quality). Also specify whether to capture images in RAW format (p.98). For guidelines on how many of each kind of image can fit on a memory card, see “Number of Shots per Memory Card” (p.220).



- Press the [INFO] button, choose [L] in the menu, and choose the desired option (p.29).
- The option you configured is now displayed.
- To restore the original setting, repeat this process but choose [L].



- [L] and [M] indicate different levels of image quality depending on the extent of compression. At the same size (number of pixels), [L] offers higher image quality. Although [M] images have slightly lower image quality, more fit on a memory card. Note that [S2] is image quality of [L].
- Not available in [RAW] mode.
- You can also configure this setting by choosing MENU (p.30) ► [CAMERA] tab ► [Image quality].

When deciding the number of pixels based on print size, use the following table as a guide for images with a 3:2 aspect ratio.

L	A2 (16.5 x 23.4 in.)
M	A3 (11.7 x 16.5 in.)
S1	A4 (8.3 x 11.7 in.)
S2	3.5 x 5 in., 5 x 7 in., Postcard

Before Use

Basic Guide

Advanced Guide

Camera Basics

Auto Mode /  
Hybrid Auto Mode

Other Shooting Modes

P Mode

Tv, Av, M, and C Mode

Playback Mode

Wi-Fi Functions

Setting Menu

Accessories

Appendix

Index



## Capturing in RAW Format

The camera can capture images in JPEG and RAW format.

JPEG Images	Processed in the camera for optimal image quality and compressed to reduce file size. However, the compression process is irreversible, and images cannot be restored to their original, unprocessed state. Image processing may also cause some loss of image quality.
RAW Images	“Raw” (unprocessed) data, recorded with essentially no loss of image quality from the camera’s image processing. The data cannot be used in this state for viewing on a computer or printing. You must first process images on the camera (132) or use the software (Digital Photo Professional, 182) to convert images to JPEG or TIFF files. Images can be adjusted with minimal loss of image quality.



- Press the **[MENU]** button, and then choose **[M]** in the menu (129).
- To capture in RAW format only, choose the **[RAW]** option.
- To capture images in both JPEG and RAW format simultaneously, choose the JPEG image quality, and then press the **[FUNC.]** button. A **[✓]** mark is displayed next to **[RAW]**. To undo this setting, follow the same steps and remove the **[✓]** mark next to **[RAW]**.



- When transferring RAW images (or RAW and JPEG images recorded together) to a computer, always use the dedicated software (182).
- Digital zoom (41) is not available when capturing images in RAW format.



- For details on the relationship between the number of recording pixels and the number of shots that will fit on a card, see “Number of Shots per Memory Card” (220).
- The file extension for JPEG images is .JPG, and the extension for RAW images is .CR2.

## Using the Menu

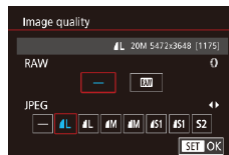

- Press the **[MENU]** button, choose **[Image quality]** on the **[1]** tab, and then press the **[MENU]** button (30).
- To capture in RAW format at the same time, turn the **[Q]** ring and choose **[RAW]** under **[RAW]**. Note that only JPEG images are captured when **[-]** is selected.
- Press the **[◀]**/**[▶]** buttons or turn the **[Q]** dial to choose **[JPEG]**, and then choose the image size and quality. Note that only RAW images are captured when **[-]** is selected.
- When finished, press the **[MENU]** button to return to the menu screen.



- **[RAW]** and **[JPEG]** cannot both be set to **[-]**.

Before Use

Basic Guide

Advanced Guide

Camera Basics

Auto Mode /  
Hybrid Auto Mode

Other Shooting Modes

P Mode

Tv, Av, M, and C Mode

Playback Mode

Wi-Fi Functions

Setting Menu

Accessories

Appendix

Index



## ■ Changing the IS Mode Settings

▶ Still Images ▶ Movies

You can keep image stabilization off until the moment you shoot.

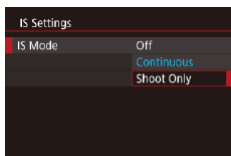

- Follow the steps in “Deactivating Image Stabilization” (152) to choose [Shoot Only].

Before Use

Basic Guide

Advanced Guide

Camera Basics

Auto Mode /  
Hybrid Auto Mode

Other Shooting Modes

P Mode

Tv, Av, M, and C Mode

Playback Mode

Wi-Fi Functions

Setting Menu

Accessories

Appendix

Index



# Tv, Av, M, and C Mode

Take smarter, more sophisticated shots, and customize the camera for your shooting style

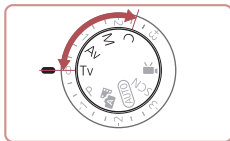

- Instructions in this chapter apply to the camera as set to the respective mode.

## Specific Shutter Speeds ([Tv] Mode)

▶ Still Images ▶ Movies

Set your preferred shutter speed before shooting as follows. The camera automatically adjusts the aperture value to suit your shutter speed. For details on available shutter speeds, see “Camera” (📖217).

### 1 Enter [Tv] mode.

- Set the mode dial to [Tv].

### 2 Set the shutter speed.

- Turn the (🔘) ring to set the shutter speed.



Shutter Speed (Sec.)	Available ISO Speed (📖80)
30 – 1.3	[AUTO], [125] – [3200]
1 – 1/2000	[AUTO], [125] – [12800]



- In conditions requiring slower shutter speeds, there may be a delay before you can shoot again, as the camera processes images to reduce noise.
- When shooting at low shutter speeds on a tripod, you should set [IS Mode] to [Off] (📖52).
- Orange display of the aperture value when you press the shutter button halfway indicates that the optimum exposure has not been obtained. Adjust the shutter speed until the aperture value is displayed in white, or use safety shift (📖101).



- [Tv]: Time value
- You can customize camera operation so that turning the (🔘) dial changes the shutter speed (📖104).

Before Use

Basic Guide

Advanced Guide

Camera Basics

Auto Mode / Hybrid Auto Mode

Other Shooting Modes

P Mode

Tv, Av, M, and C Mode

Playback Mode

Wi-Fi Functions

Setting Menu

Accessories

Appendix

Index





## Specific Aperture Values ([Av] Mode)

▶ Still Images ▶ Movies

Set your preferred aperture value before shooting as follows. The camera automatically adjusts the shutter speed to suit your aperture value. For details on available aperture values, see “Camera” (1217).

### 1 Enter [Av] mode.

- Set the mode dial to [Av].



### 2 Set the aperture value.

- Turn the (1/2) ring to set the aperture value.



- Orange display of the shutter speed when you press the shutter button halfway indicates that the optimum exposure has not been obtained. Adjust the aperture value until the shutter speed is displayed in white, or use safety shift (see below).



- [Av]: Aperture value (size of the opening made by the diaphragm in the lens)
- In [Tv] and [Av] modes, press the [MENU] button and set [Safety Shift] on the [6] tab to [On] (130) to have the camera automatically adjust the shutter speed and aperture value when there are exposure problems, so that you can shoot at the optimum exposure. However, safety shift is disabled when the flash fires.
- You can customize camera operation so that turning the (1/2) dial changes the aperture value (104).

## Specific Shutter Speeds and Aperture Values ([M] Mode)

▶ Still Images ▶ Movies

Follow these steps before shooting to set your preferred shutter speed and aperture value to obtain the desired exposure.

For details on available shutter speeds and aperture values, see “Camera” (1217).

### 1 Enter [M] mode.

- Set the mode dial to [M].

### 2 Configure the setting.

- Turn the (1/2) dial to set the shutter speed (1).
- Turn the (1/2) ring to set the aperture value (2).
- When the ISO speed is fixed, an exposure level mark (4) based on your specified values is shown on the exposure level indicator for comparison to the standard exposure level (3). The exposure level mark is shown as [◀] or [▶] when the difference from standard exposure exceeds 3 stops.
- The ISO speed is determined and screen brightness changes when you press the shutter button halfway after setting the ISO speed to [AUTO]. If standard exposure cannot be obtained with your specified shutter speed and aperture value, the ISO speed is displayed in orange.



(1) (2)

(3)

(4)

Before Use

Basic Guide

Advanced Guide

Camera Basics

Auto Mode / Hybrid Auto Mode

Other Shooting Modes

P Mode

Tv, Av, M, and C Mode

Playback Mode

Wi-Fi Functions

Setting Menu

Accessories

Appendix

Index



Shutter Speed (Sec.)	Available ISO Speed (📖80)
[BULB], 30 – 1.3	[AUTO], [125] – [3200]
1 – 1/2000	[AUTO], [125] – [12800]



- After you set the shutter speed and aperture value, the exposure level may change if you adjust the zoom or recompose the shot.
- Screen brightness may change depending on your specified shutter speed and aperture value. However, screen brightness remains the same when the flash is up and the mode is set to [🔧].
- Image brightness may be affected by the Auto Lighting Optimizer (📖81). To keep the Auto Lighting Optimizer disabled in [M] mode, touch [🔧] on the Auto Lighting Optimizer setting screen to add a [✓] mark to [Disable during man expo].



- **M**: Manual
- Calculation of optimum exposure is based on the specified metering method (📖79).
- The following operations are available when ISO speed is set to [AUTO].
  - Adjust exposure by turning the exposure compensation dial.
  - Touch [✖] to lock the ISO speed. Screen brightness changes accordingly.

## Shooting Long Exposures (Bulb)

With bulb exposures, shots are exposed for as long as you hold down the shutter button.

### 1 Specify bulb exposure.

- Set the shutter speed to [BULB], following steps 1 – 2 in “Specific Shutter Speeds and Aperture Values ([M] Mode)” (📖101).

### 2 Shoot.

- Shots are exposed for as long as you hold the shutter button all the way down. The elapsed exposure time is displayed during exposure.



- Maximum continuous shooting time with this feature is 4 min. 16 sec.
- Mount the camera on a tripod or take other measures to keep it still and prevent camera shake. In this case, also disable image stabilization (📖52).



- Remote shooting (📖164) function can be used to avoid camera shake that may otherwise occur when pressing the shutter button directly.



- When [Touch Shutter] is set to [Enable], shooting is started by touching the screen once and stopped by touching it again. Be careful not to move the camera when touching the screen.

Before Use

Basic Guide

Advanced Guide

Camera Basics

Auto Mode / Hybrid Auto Mode

Other Shooting Modes

P Mode

Tv, Av, M, and C Mode

Playback Mode

Wi-Fi Functions

Setting Menu

Accessories

Appendix

Index



## Adjusting the Flash Output

▶ Still Images ▶ Movies

Choose from the three flash levels in [Tv][Av][M] modes.

### 1 Specify the flash mode.

- Press the [MENU] button, choose [Flash Settings] on the [5] tab, and then press the [5] button (30).
- Press the [▲]/[▼] buttons or turn the [DIAL] dial to choose [Flash Mode], choose [Manual], and then press the [5] button.

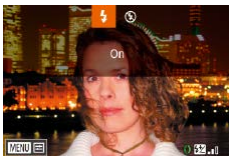

### 2 Configure the setting.

- Raise the flash, press the [▶] button and immediately turn the [DIAL] ring to choose the flash output level, and then press the [5] button.
- Once the setting is complete, the flash output level is displayed.  
[50%]: Minimum, [75%]: Medium, [100%]: Maximum



- You can also set the flash level by accessing MENU (30) and choosing [5] tab ▶ [Flash Settings] ▶ [Flash Output].
- You can also access the [Flash Settings] screen (30) when the flash is up by pressing the [▶] button and immediately pressing the [MENU] button.



- You can also access the [Flash Settings] screen (30) by pressing the [▶] button and touching [MENU].

## Recording Movies at Specific Shutter Speeds and Aperture Values

▶ Still Images ▶ Movies

Set your preferred shutter speed, exposure, aperture value, and ISO speed.

For details on available shutter speeds, see “Camera” (217). For details on available aperture values and ISO speeds, see “Aperture” (218) and “Changing the ISO Speed” (80).

### 1 Enter [Pv] mode.

- Set the mode dial to [Pv].
- Press the [5] button, choose [Pv] in the menu, and then choose [Pv] (29).

### 2 Configure the settings.

- Turn the [DIAL] dial to set the shutter speed.
- Turn the [DIAL] ring to set the aperture value.



### 3 Shoot.

- Press the movie button.
- You can also adjust settings while recording, as described in step 2.



- Some shutter speeds may cause flickering on the screen when recording under fluorescent or LED lighting, which may be recorded.

Before Use

Basic Guide

Advanced Guide

Camera Basics

Auto Mode /  
Hybrid Auto Mode

Other Shooting Modes

P Mode

Tv, Av, M, and C Mode

Playback Mode

Wi-Fi Functions

Setting Menu

Accessories

Appendix

Index





- With the ISO speed in [AUTO] mode, you can also adjust the exposure before recording by turning the exposure compensation dial.
- When the ISO speed is fixed, an exposure level mark based on your specified value is shown on the exposure level indicator for comparison to the standard exposure level. The exposure level mark is shown as [◀] or [▶] when the difference from standard exposure exceeds 3 stops.
- You can check the ISO speed in [AUTO] mode by pressing the shutter button halfway. If standard exposure cannot be obtained with your specified shutter speed and aperture value, the ISO speed is displayed in orange.



- Focus can be adjusted during recording by touching [AF] (to switch it to [MF]) and then pressing the [▲]/[▼] buttons.

## Customization for Shooting Styles

### Changing Control Ring Settings

▶ Still Images ▶ Movies

Reassign control ring functions as follows. Using the control ring is an enjoyable way to control the camera as you would a fully manual camera.



#### 1 Choose a function to assign to the [C] ring.

- Press the [RING FUNC.] button.
- Choose an option, either by pressing the [RING FUNC.] or [◀]/[▶] buttons or by turning the [C] ring or [DIAL] dial.
- Press the [OK] button to complete the setting.

#### 2 Configure the assigned function.

- Turn the [C] ring or the [DIAL] dial to configure the assigned function.



- You can also configure this setting by pressing the [RING FUNC.] button, touching an option to choose it, and then touching it again.

Before Use

Basic Guide

Advanced Guide

Camera Basics

Auto Mode / Hybrid Auto Mode

Other Shooting Modes

P Mode

Tv, Av, M, and C Mode

Playback Mode

Wi-Fi Functions

Setting Menu

Accessories

Appendix

Index



## Functions Assignable to the Control Ring

Functions you can assign to the control ring vary depending on shooting mode. These then determine which functions you can assign to the control dial.

Item	Shooting Mode			
	Av	Tv	P	
STD		Av	Tv	Step Zoom
		—	—	—
ISO		ISO	ISO	ISO
		Av	Tv	—
MF		Focus manually (📖87)		
WB +/-		Correct white balance (📖83)		
		Perform step zoom (📖41)		
		Perform seamless zoom (📖42)		
		Configure the effect of the Auto Lighting Optimizer (📖81)		
		Adjust the aspect ratio (📖49)		
C	—	Assign functions as desired (📖105)		

- ISO: ISO speed (📖80); MF: manual focus (📖87); Tv: shutter speed (📖100); Av: aperture value (📖101).
- When you assign [MF], [WB +/-], [Zoom], [Zoom], [Lighting Optimizer] or [Aspect Ratio] to the [C] ring, the functions you can assign to the [C] dial are the same as for [ISO].



- Icons labeled with [C] indicate that the function is not available in the current shooting mode or under current function conditions.
- When using [AUTO], [A-F], or [SCN], step zoom or seamless zoom can be assigned with the [C] ring (📖41).
- When in [M] or [P] mode, aperture value or shutter speed can be assigned.

## Assigning Functions to the Control Ring

► Still Images ► Movies

Assign functions to the control ring based on each shooting mode.

### 1 Choose [C].

- Following step 1 in “Changing Control Ring Settings” (📖104), choose [C] and press the [MENU] button.

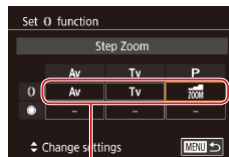

(1)

### 2 Configure the setting.

- Press the [◀][▶] buttons or turn the [C] dial to choose the shooting mode with function to assign.
- Press the [▲][▼] buttons or turn the [C] ring to choose a function to assign to the control ring (1).
- Functions you can assign to the control dial will be updated automatically.
- Press the [MENU] button to return to the shooting screen.



- On the setting screen, you can also configure the functions assigned to the control ring by touching the functions and then [MENU].
- You can also access the setting screen by choosing [C] and touching [MENU] in step 1 of “Changing Control Ring Settings” (📖104).

Before Use

Basic Guide

Advanced Guide

Camera Basics

Auto Mode / Hybrid Auto Mode

Other Shooting Modes

P Mode

Tv, Av, M, and C Mode

Playback Mode

Wi-Fi Functions

Setting Menu

Accessories

Appendix

Index



## Customizing Display Information

Customize what screen is displayed when you press the [▼] button on the shooting screen. You can also customize what information is displayed.

### 1 Access the setting screen.

- On the [CAMERA] tab, choose [Screen info/ toggle settings] in [Shooting information display], and then press the [INFO] button (p.30).

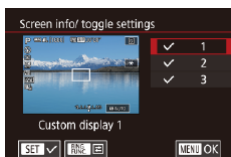

### 2 Configure the setting.

- Press the [▲][▼] buttons or turn the [DISP.] dial to choose any screen you prefer not to display, and then press the [INFO] button to remove the [✓] mark. Pressing the [INFO] button again will add the [✓] mark, which indicates that it is selected for display.
- To return to the menu screen, press the [MENU] button.



- An example of display with the options selected in step 2 is shown at left for reference.
- At least one option must be selected.

## Customizing the Information Displayed

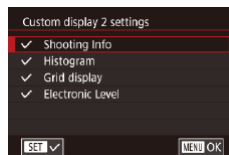

- Follow steps 1 – 2 in “Customizing Display Information” (p.106) to choose [Custom display 1] or [Custom display 2], and then press the [RING FUNC.] button.
- Press the [▲][▼] buttons or turn the [DISP.] dial to choose information to display, and then press the [INFO] button to add a [✓] mark.
- To see an example of display, press the [MENU] button to return to the [Screen info/ toggle settings] screen.



- For a smaller grid pattern, access [CAMERA] tab ▶ [Shooting information display] ▶ [Grid display].

## Assigning Functions to Buttons

▶ Still Images ▶ Movies

You can quickly and easily activate functions that you assign to the movie button or the [RING FUNC.] button.



### 1 Access the setting screen.

- Press the [MENU] button, choose [Set button] or [Set RING FUNC. button] on the [CAMERA] tab, and then press the [INFO] button (p.30).

### 2 Configure the setting.

- Press the [▲][▼][◀][▶] buttons or turn the [DISP.] dial to choose a function to assign, and then press the [INFO] button.

Before Use

Basic Guide

Advanced Guide

Camera Basics

Auto Mode /  
Hybrid Auto Mode

Other Shooting Modes

P Mode

Tv, Av, M, and C Mode

Playback Mode

Wi-Fi Functions

Setting Menu

Accessories

Appendix

Index



### 3 Use the assigned function as needed.

- To activate an assigned function, press the button you assigned it to.



- To restore default settings, choose [MENU] in [Set] button and [RING FUNC] in [Set] button.
- Icons labeled with [NO] indicate that the function is not available in the current shooting mode or under current function conditions.
- With [AF-ON], you can move and resize the AF frame by pressing the assigned button in the [1-point AF] AF frame mode (p. 90, p. 90).
- With [AF-L], each press of the button that it is assigned to adjusts and locks the focus, and [AF-L] is displayed on the screen.
- With [DISP], pressing the button that it is assigned to deactivates screen display. To restore the display, do any of the following.
  - Press any button other than the power button
  - Hold the camera in another orientation
  - Open or close the screen
  - Raise or lower the flash
- You can still record movies in [MOVIE], [4K], [4K], [4K], or [MOVIE] mode even if you assign a function to the movie button.



- You can also configure settings by touching a desired option and then touching it again or touching [SET].

## Customizing the Quick Set Menu

▶ Still Images ▶ Movies

The display of Quick Set menu items can be customized.

### Choosing Items to Include in the Menu



#### 1 Access the setting screen.

- Press the [MENU] button, choose [Quick setting menu layout] on the [CAMERA] tab, and then press the [OK] button (p. 30).

#### 2 Choose icons to include in the menu.

- Press the [LEFT] [RIGHT] buttons or turn the [INFO] ring or the [DISP] dial to choose an icon, and then press the [OK] button to label icons you want to display in the Quick Set menu with [✓].
- Selected items (labeled with a [✓]) will be included in display.
- Items without a [✓] can be configured on the [CAMERA] tab of the menu screen.

#### 3 Complete the setting.

- Press the [MENU] button, choose [OK] (either press the [LEFT] [RIGHT] buttons or turn the [INFO] ring or the [DISP] dial), and then press the [OK] button.



- Up to 11 items can be displayed in the menu.
- The screen in step 2 can also be accessed by holding down the [OK] button when the Quick Set menu is displayed.

Before Use

Basic Guide

Advanced Guide

Camera Basics

Auto Mode / Hybrid Auto Mode

Other Shooting Modes

P Mode

Tv, Av, M, and C Mode

Playback Mode

Wi-Fi Functions

Setting Menu

Accessories

Appendix

Index





- You can also choose an icon by touching it on the screen in step 2.

## Rearranging Menu Items



### 1 Access the setting screen.

- On the screen in step 2 of “Choosing Items to Include in the Menu” (107), press the **[PUNCH]** button.
- Press the **[▲]**/**[▼]** buttons or turn the **[DIAL]** ring or the **[DISK]** dial to choose the icon to replace, and then press the **[SET]** button.
- Press the **[▲]**/**[▼]** buttons or turn the **[DIAL]** ring or the **[DISK]** dial to choose the new position, and then press the **[SET]** button.

### 2 Configure the setting.

- Press the **[MENU]** button, choose **[OK]** (either press the **[◀]**/**[▶]** buttons or turn the **[DIAL]** ring or the **[DISK]** dial), and then press the **[SET]** button.



- You can also replace an icon using drag.

## Saving Shooting Settings

▶ Still Images ▶ Movies

Save commonly used shooting modes and your configured function settings for reuse. To access saved settings later, simply turn the mode dial to **[C]**. Even settings that are usually cleared when you switch shooting modes or turn the camera off (such as self-timer settings) can be retained this way.

### Settings That Can Be Saved

- Shooting modes (**[P]**, **[Tv]**, **[Av]**, and **[M]**)
- Items set in **[P]**, **[Tv]**, **[Av]**, and **[M]** modes (78 – 101)
- Shooting menu settings
- Zoom positions
- Manual focus positions (87)
- My Menu settings (109)

### 1 Enter a shooting mode with settings you want to save, and change the settings as desired.

### 2 Configure the setting.

- Press the **[MENU]** button, choose **[Save Settings]** on the **[CAMERA]** tab, and then press the **[SET]** button.

### 3 Save the settings.

- Press the **[◀]**/**[▶]** buttons or turn the **[DISK]** dial to choose **[OK]**, and then press the **[SET]** button.

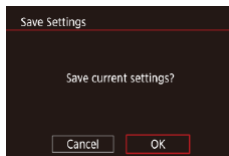

Before Use

Basic Guide

Advanced Guide

Camera Basics

Auto Mode / Hybrid Auto Mode

Other Shooting Modes

P Mode

Tv, Av, M, and C Mode

Playback Mode

Wi-Fi Functions

Setting Menu

Accessories

Appendix

Index







- To edit saved settings (except their shooting mode), choose [C], change the settings, and then repeat steps 2 – 3. These setting details are not applied in other shooting modes.



- To clear information you have saved to [C] and restore default values, turn the mode dial to [C] and choose [Reset All] (p.176).

## Saving Commonly Used Shooting Menu Items (My Menu)

► Still Images ► Movies

You can save up to six commonly used shooting menu items on the [★1] tab. By customizing the [★1] tab, you can access these items quickly from a single screen.

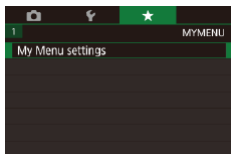

### 1 Access the setting screen.

- Press the [MENU] button, choose [My Menu settings] on the [★1] tab, and then press the [OK] button (p.30).

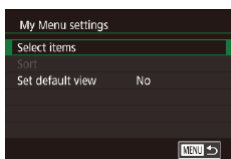

### 2 Configure the setting.

- Press the [▲][▼] buttons or turn the [DISP.] dial to choose [Select items], and then press the [OK] button.
- Press the [▲][▼] buttons or turn the [DISP.] dial to choose a menu item to save (max. six items) and then press the [OK] button to save it.
- [✓] is displayed.
- To cancel saving, press the [OK] button. [✓] is no longer displayed.
- Press the [MENU] button.

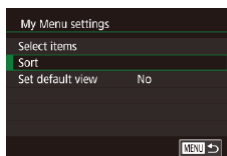

### 3 Rearrange menu items, as needed.

- Press the [▲][▼] buttons or turn the [DISP.] dial to choose [Sort], and then press the [OK] button.
- Choose a menu item to move (either press the [▲][▼] buttons or turn the [DISP.] dial), and then press the [OK] button.
- Press the [▲][▼] buttons or turn the [DISP.] dial to change the order, and then press the [OK] button.
- Press the [MENU] button.



- Grayed-out items in step 2 can also be specified, but they may not be available in some shooting modes.



- To make My Menu immediately accessible by pressing the [MENU] button in Shooting mode, set [Set default view] to [Yes].



- On the [Select items] screen for saving or clearing items, you can also touch items to select them.
- On the [Sort] screen, you can also drag items to change the display order.

Before Use

Basic Guide

Advanced Guide

Camera Basics

Auto Mode / Hybrid Auto Mode

Other Shooting Modes

P Mode

Tv, Av, M, and C Mode

Playback Mode

Wi-Fi Functions

Setting Menu

Accessories

Appendix

Index



# Playback Mode

Have fun reviewing your shots, and browse or edit them in many ways

- To prepare the camera for these operations, press the [▶] button to enter Playback mode.



- It may not be possible to play back or edit images that were renamed or already edited on a computer, or images from other cameras.

## Viewing

▶ Still Images ▶ Movies

After shooting images or movies, you can view them on the screen as follows.



### 1 Enter Playback mode.

- Press the [▶] button.
- Your last shot is displayed.



### 2 Choose images.

- To view the previous image, press the [◀] button or turn the [●] dial counterclockwise. To view the next image, press the [▶] button or turn the [●] dial clockwise.
- Press and hold the [◀][▶] buttons to browse through images quickly.

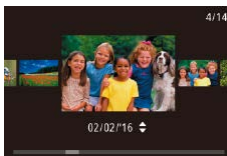

- To access this screen (Scroll Display mode), turn the [●] dial rapidly. In this mode, turn the [●] dial to browse through images.
- To return to single-image display, press the [⊙] button.
- To browse images grouped by shooting date, press the [▲][▼] buttons in Scroll Display mode.
- Movies are identified by a [SET ▶] icon. To play movies, go to step 3.

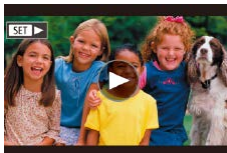

Before Use

Basic Guide

Advanced Guide

Camera Basics

Auto Mode / Hybrid Auto Mode

Other Shooting Modes

P Mode

Tv, Av, M, and C Mode

Playback Mode

Wi-Fi Functions

Setting Menu

Accessories

Appendix

Index





### 3 Play movies.

- To start playback, press the [RECALL] button to access the movie control panel, press the [▲][▼] buttons to choose [▶], and then press the [RECALL] button again.



### 4 Adjust the volume.

- Press the [▲][▼] buttons to adjust the volume.
- To adjust the volume when the volume indicator (1) is no longer displayed, press the [▲][▼] buttons.

(1)

### 5 Pause playback.

- To pause or resume playback, press the [RECALL] button.
- After the movie is finished, [SET ▶] is displayed.



- To switch to Shooting mode from Playback mode, press the shutter button halfway.
- To deactivate Scroll Display, choose MENU (M/30) ▶ [▶5] tab ▶ [Scroll Display] ▶ [Off].
- To have the most recent shot displayed when you enter Playback mode, choose MENU (M/30) ▶ [▶5] tab ▶ [Resume] ▶ [Last shot].
- To change the transition shown between images, access MENU (M/30) and choose your desired effect on the [▶5] tab ▶ [Transition Effect].

## Touch-Screen Operations

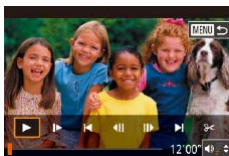
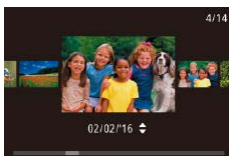
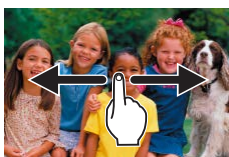

- To view the next image, drag left across the screen, and to view the previous image, drag right.

- To access Scroll Display mode, quickly drag left or right repeatedly.

- You can also browse through images in Scroll Display mode by dragging left or right.

- Touching the central image will restore single-image display.

- To browse images grouped by shooting date in Scroll Display mode, quickly drag up or down.

- To start movie playback, touch [▶] on the screen in step 2 of "Viewing" (M/110).

- To adjust the volume during movie playback, quickly drag up or down across the screen.

- To stop playback, touch the screen. The screen shown at left is displayed, and the following operations are available.

- Touch [M/110] to display the volume panel, and then touch [▲][▼] to adjust the volume. At a volume of 0, [M/110] is displayed.

- To switch frames, touch the scrollbar or drag left or right.

- To resume playback, touch [▶].

- Touch [MENU] to return to the screen in step 2 of "Viewing" (M/110).

Before Use

Basic Guide

Advanced Guide

Camera Basics

Auto Mode / Hybrid Auto Mode

Other Shooting Modes

P Mode

Tv, Av, M, and C Mode

Playback Mode

Wi-Fi Functions

Setting Menu

Accessories

Appendix



Index



## Switching Display Modes

▶ Still Images ▶ Movies

Press the [▼] button in Playback mode to switch from “No Information Display” to “Simple Information Display” to “Detailed Information Display” to “RGB Histogram/GPS Information Display”.

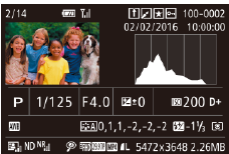
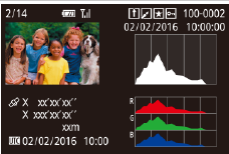
	No Information Display
	Simple Information Display
	Detailed Information Display
	RGB Histogram, GPS Information Display



- Switching display modes is not possible while the camera is connected via Wi-Fi to devices other than printers.

## Customizing the Shooting Information Displayed

Customize the information shown on each screen. Info Display 4 shows the white balance information, and Info Display 5 shows the Picture Style information.

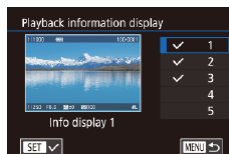
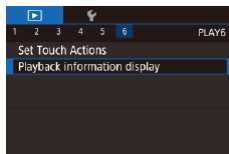

### 1 Access the setting screen.

- Choose [Playback information display] on the [▶]6] tab, and then press the [INFO] button.

### 2 Choose information to display.

- Press the [▲][▼] buttons to choose information to display, and then press the [INFO] button to add a [✓] mark.
- To return to the menu screen, press the [MENU] button.



- An example of display with the options selected in step 2 is shown at left for reference.

## Overexposure Warning (for Image Highlights)

▶ Still Images ▶ Movies

Washed-out highlights in the image flash on the screen in detailed information display (112).

Before Use

Basic Guide

Advanced Guide

Camera Basics

Auto Mode / Hybrid Auto Mode

Other Shooting Modes

P Mode

Tv, Av, M, and C Mode

Playback Mode

Wi-Fi Functions

Setting Menu

Accessories

Appendix

Index



## Histogram

▶ Still Images ▶ Movies

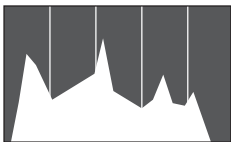

- The graph in detailed information display (📖 112) is a histogram showing the distribution of brightness in the image. The horizontal axis represents the degree of brightness, and the vertical axis, how much of the image is at each level of brightness. Viewing the histogram is a way to check exposure.
- The histogram can also be accessed while shooting (📖 106, 📖 197).

## RGB Histogram, GPS Information Display

▶ Still Images ▶ Movies

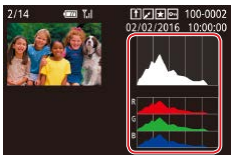

- The RGB histogram shows the distribution of shades of red, green, and blue in an image. The horizontal axis represents R, G, or B brightness, and the vertical axis, how much of the image is at that level of brightness. Viewing this histogram enables you to check image color characteristics.

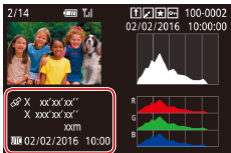

- Using a smartphone connected to the camera via Wi-Fi, you can geotag images on the camera, adding information such as latitude, longitude, and elevation (📖 164). You can review this information in the GPS information display.
- Latitude, longitude, elevation, and UTC (shooting date and time) are listed from top to bottom.



- [---] is shown instead of numerical values for items not available on your smartphone or items not recorded correctly.



- You can also display an RGB histogram at the top of the Info Display 2 – 6 screens. Choose Info Display 2 – 5 on the [Playback information display] setting screen on the [▶6] tab, press the [INFO] button, press the [▲][▼] buttons to choose [RGB], and then press the [OK] button. Note that the brightness histogram is now displayed at the bottom of the Info Display 3 screen.
- UTC: Coordinated Universal Time, essentially the same as Greenwich Mean Time
- GPS information display is not available for images that lack this information.



- You can also switch between the RGB histogram (still images only) and GPS information display by dragging the lower half of the screen upward or downward in detailed information display.

Before Use

Basic Guide

Advanced Guide

Camera Basics

Auto Mode /  
Hybrid Auto Mode

Other Shooting Modes

P Mode

Tv, Av, M, and C Mode

Playback Mode

Wi-Fi Functions

Setting Menu

Accessories

Appendix

Index



## Viewing Short Movies Created When Shooting Still Images (Digest Movies)

▶ Still Images ▶ Movies

View digest movies recorded automatically in [S] mode (136) on a day of still image shooting as follows.



### 1 Choose an image.

- Still images shot in [S] mode are labeled with [S] icon.
- Choose a still image labeled with [S] and press the [S] button.



### 2 Play the digest movie.

- Press the [▲][▼] buttons to choose [S], and then press the [S] button.
- The movie recorded automatically on the day of still image shooting is played back, from the beginning.



- After a moment, [S] will no longer be displayed when you are using the camera with information display deactivated (112).

## Viewing by Date

Digest movies can be viewed by date.

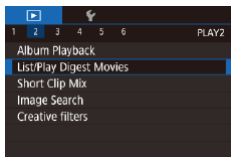

- Press the [MENU] button, choose [List/Play Digest Movies] on the [2] tab, and then touch a date (130).

## Checking People Detected in Face ID

▶ Still Images ▶ Movies

If you switch the camera to simple information display mode (112), the names of up to five detected people registered in Face ID (45) will be displayed.



- Press the [▼] button several times until simple information display is activated, and then press the [◀][▶] buttons or turn the [DISP] dial to choose an image.
- Names will be displayed on detected people.



- If you prefer not to have names displayed on images shot using Face ID, choose MENU (30) ▶ [3] tab ▶ [Face ID Info] ▶ [Name Display] ▶ [Off].

Before Use

Basic Guide

Advanced Guide

Camera Basics

Auto Mode / Hybrid Auto Mode

Other Shooting Modes

P Mode

Tv, Av, M, and C Mode

Playback Mode

Wi-Fi Functions

Setting Menu

Accessories

Appendix

Index



## Browsing and Filtering Images

### Navigating through Images in an Index

► Still Images ► Movies

By displaying multiple images in an index, you can quickly find the images you are looking for.

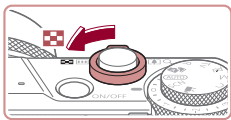







#### 1 Display images in an index.



- Move the zoom lever toward  to display images in an index. Moving the lever again will increase the number of images shown.
- To display fewer images, move the zoom lever toward [Q]. Fewer images are shown each time you move the lever.



#### 2 Choose an image.

- Turn the  dial to scroll through the images.
- Press the [][][][] buttons to choose an image.
- An orange frame is displayed around the selected image.
- Press the [] button to view the selected image in single-image display.



- To deactivate the 3D display effect (shown if you hold down the [][] buttons), choose MENU () ► [D5] tab ► [Index Effect] ► [Off].

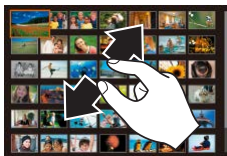

## Touch-Screen Operations







- Pinch in to switch from single-image display to index display.
- To view more thumbnails per screen, pinch in again.
- Drag up or down on the screen to scroll through displayed images.
- To view fewer thumbnails per screen, spread your fingers apart.
- Touch an image to choose it, and touch it again to view it in single-image display.

### Finding Images Matching Specified Conditions

► Still Images ► Movies

Find desired images quickly on a memory card full of images by filtering image display according to your specified conditions. You can also protect () 121) or delete () 123) these images all at once.

★ Favorites	Displays images tagged as favorites (  ) 126).
📅 Shot Date	Displays the images shot on a specific date.
👤 People	Displays images with detected faces.
📷 Still image/ Movie	Displays still images, movies, or movies shot in [  ] mode (  ) 36).
👤 Name	Displays images of a registered person (  ) 45).

Before Use

Basic Guide

Advanced Guide

Camera Basics

Auto Mode / Hybrid Auto Mode

Other Shooting Modes

P Mode

Tv, Av, M, and C Mode

Playback Mode

Wi-Fi Functions

Setting Menu

Accessories

Appendix

Index





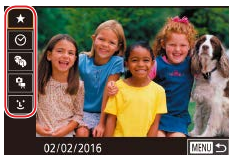

## 1 Choose the first condition.

- In single-image display, press the button, choose in the menu, and choose a condition.
- When or is selected, you can view only images matching this condition by pressing the buttons or turning the dial. To perform an action for all of these images together, press the button and go to step 3.

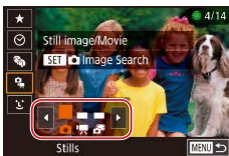

## 2 Choose the second condition and view the filtered images.

- When you have selected or as the first condition, choose the second by pressing the buttons, and then turn the dial to view only matching images.
- To switch to filtered image display, press the button and go to step 3.
- When you have selected as the first condition, press the button, and press the buttons on the next screen to choose a person.

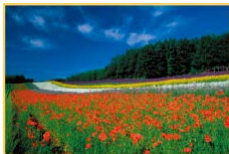

## 3 View the filtered images.

- Images matching your conditions are displayed in yellow frames. To view only these images, press the buttons, or turn the dial.
- To cancel filtered display, press the button, choose in the menu, and then press the button again.



- When the camera has found no corresponding images for some conditions, those conditions will not be available.



- To hide or view other information, press the button in step 3.
- Options for viewing the images found (in step 3) include “Navigating through Images in an Index” (115), “Magnifying Images” (119), and “Viewing Slideshows” (120). You can also apply image operations to all images found, by choosing [Protect All Images in Search] in “Protecting Images” (121) or [Select All Images in Search] in “Erasing Multiple Images at Once” (124), “Adding Images to the Print List (DPOF)” (187), or “Adding Images to a Photobook” (190).
- If you edit images and save them as new images (128 – 135), a message is displayed, and the images that were found are no longer shown.



- You can also choose conditions by touching the screens in steps 1 and 2.
- After choosing conditions, you can view images matching your conditions by touching a condition again.

Before Use

Basic Guide

Advanced Guide

Camera Basics

Auto Mode /  
Hybrid Auto Mode

Other Shooting Modes

P Mode

Tv, Av, M, and C Mode

Playback Mode

Wi-Fi Functions

Setting Menu

Accessories

Appendix

Index





## Using the Control Ring to Jump between Images

► Still Images ► Movies

Use the control ring to find and jump between desired images quickly by filtering image display according to your specified conditions.

Jump to Favorites	Displays images tagged as favorites (📖126).
Jump Shot Date	Jumps to the first image in each group of images that were shot on the same date.
Single image	Jumps by 1 image at a time.
Jump 10 Images	Jumps by 10 images at a time.
Jump 100 Images	Jumps by 100 images at a time.



### 1 Choose a condition.

- Choose a condition (or jump method) in single-image display by turning the [🔍] ring and immediately pressing the [▲][▼] buttons.

### 2 View images matching your specified condition, or jump by the specified amount.

- Turn the [🔍] ring to view only images matching the condition or jump by the specified number of images forward or back.

## Touch-Screen Operations

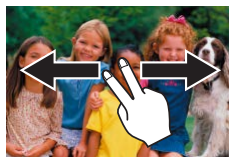

- You can also jump to the previous or next image according to your jump method chosen in step 1 of “Using the Control Ring to Jump between Images” (📖117) by dragging left or right with two fingers.

## Viewing Individual Images in a Group

► Still Images ► Movies

Images saved as source data in [📄] mode (📖68) are grouped, and only the first image is displayed. However, you can also view the images individually.



### 1 Choose a grouped image.

- Press the [◀][▶] buttons or turn the [🔍] dial to choose an image labeled with [SET].

### 2 Choose [📄].

- Press the [🔍] button, and then choose [📄] in the menu (📖29).

### 3 View images in the group individually.

- Pressing the [◀][▶] buttons or turning the [🔍] dial will display only images in the group.
- To cancel group playback, press the [🔍] button, choose [📄] in the menu, and press the [🔍] button again (📖29).

Before Use

Basic Guide

Advanced Guide

Camera Basics

Auto Mode / Hybrid Auto Mode

Other Shooting Modes

P Mode

Tv, Av, M, and C Mode

Playback Mode

Wi-Fi Functions

Setting Menu

Accessories

Appendix

Index





- During group playback (step 3), you can browse through images quickly “Navigating through Images in an Index” (📖115) and magnify them “Magnifying Images” (📖119). You can apply your actions to all images in the group at once by choosing [Protect All Images in Group] in “Protecting Images” (📖121), [All Images in Group] in “Erasing Multiple Images at Once” (📖124), [Select All in Group] in “Adding Images to the Print List (DPOF)” (📖187), or [Select All in Group] in “Adding Images to a Photobook” (📖190).
- To ungroup images so that they are displayed only as single still images, choose MENU (📖30) ► [▶]5 tab ► [Group Images] ► [Off] (📖30). However, grouped images cannot be ungrouped during individual playback.

## Editing Face ID Information

If you notice that a name is incorrect during playback, you can change it or erase it.

However, you cannot add names for people who are not detected by Face ID (names are not displayed), and for people whose names have been erased.

### Changing Names

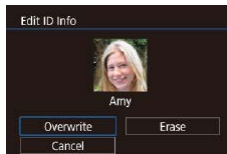
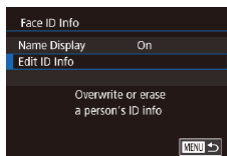

#### 1 Access the setting screen.

- Press the [MENU] button and choose [Face ID Info] on the [▶]3 tab (📖30).
- Press the [▲][▼] buttons or turn the [🌀] dial to choose [Edit ID Info], and then press the [📖] button.

#### 2 Choose an image.

- Following the procedure in “Checking People Detected in Face ID” (📖114), choose an image and press the [📖] button.
- An orange frame is displayed around the selected face. When multiple names are displayed in an image, press the [◀][▶] buttons or turn the [🌀] dial to choose the name to change, and then press the [📖] button.

#### 3 Choose the editing option.

- Press the [▲][▼][◀][▶] buttons or turn the [🌀] dial to choose [Overwrite], and then press the [📖] button.

Before Use

Basic Guide

Advanced Guide

Camera Basics

Auto Mode / Hybrid Auto Mode

Other Shooting Modes

P Mode

Tv, Av, M, and C Mode

Playback Mode

Wi-Fi Functions

Setting Menu

Accessories

Appendix

Index



#### 4 Choose the name of the person to overwrite with.

- Follow step 2 in “Overwriting and Adding Face Information” (48) to choose the name of the person you want to overwrite with.



- You can also access the [Edit ID Info] screen by touching an image on the screen in step 2, touching [SET] to display the orange frame, and then touching the face to overwrite its name.
- You can also choose editing options by touching them in step 3.

## Erasing Names

- On the screen displayed in step 3 in “Changing Names” (118), choose [Erase] and press the [OK] button.
- After [Erase?] is displayed, press the [Left][Right] buttons or turn the [Dial] to choose [OK], and then press the [OK] button.

## Image Viewing Options

### Magnifying Images

▶ Still Images ▶ Movies

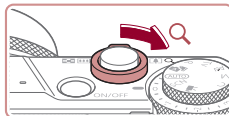

(1)

#### 1 Magnify an image.

- Moving the zoom lever toward [Q] will zoom in and magnify the image. You can magnify images up to about 10x by continuing to hold the zoom lever.
- The approximate position of the displayed area (1) is shown for reference.
- To zoom out, move the zoom lever toward [Q]. You can return to single-image display by continuing to hold it.

#### 2 Move the display position and switch images as needed.

- To move the display position, press the [Up][Down][Left][Right] buttons.
- To switch to other images while zoomed, turn the [Dial].



- You can return to single-image display from magnified display by pressing the [MENU] button.
- You can check the focus when [SET] is displayed by pressing the [OK] button to show the position in focus (Focus Check). When multiple positions are in focus, press the [OK] button repeatedly to switch to other positions.

Before Use

Basic Guide

Advanced Guide

Camera Basics

Auto Mode / Hybrid Auto Mode

Other Shooting Modes

P Mode

Tv, Av, M, and C Mode

Playback Mode

Wi-Fi Functions

Setting Menu

Accessories

Appendix

Index



## Touch-Screen Operations



- Spread your fingers apart (pinch out) to zoom in.
- You can magnify images up to about 10x by repeating this action.
- To move the display position, drag across the screen.



- Pinch in to zoom out.
- Touch **[MENU]** to restore single-image display.

## Viewing Slideshows

► Still Images ► Movies

Automatically play back images from a memory card.

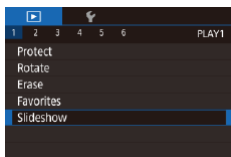

- Press the **[MENU]** button, and then choose [Slideshow] on the **[▶ 1]** tab (📖30).
- Press the **[▲][▼]** buttons or turn the **[DISP]** dial to choose [Start], and then press the **[SET]** button.
- The slideshow will start after [Loading image] is displayed for a few seconds.
- Press the **[MENU]** button to stop the slideshow.



- The camera's power-saving functions (📖27) are deactivated during slideshows.



- To pause or resume slideshows, press the **[SET]** button.
- You can switch to other images during playback by pressing the **[◀][▶]** buttons or turning the **[DISP]** dial. For fast-forward or fast-rewind, hold the **[◀][▶]** buttons down.
- You can configure slideshow repetition, display time per image, and the transition between images on the screen accessed by choosing [Set up] and pressing the **[SET]** button (📖30).



- You can also stop slideshows by touching the screen.

Before Use

Basic Guide

Advanced Guide

Camera Basics

Auto Mode /  
Hybrid Auto Mode

Other Shooting Modes

P Mode

Tv, Av, M, and C Mode

Playback Mode

Wi-Fi Functions

Setting Menu

Accessories

Appendix

Index



## Protecting Images

► Still Images ► Movies

Protect important images to prevent accidental erasure (123).



- Press the **[MENU]** button, choose **[Protect]** in the menu, and then choose **[OK]** (either press the **[Left]**/**[Right]** buttons or turn the **[Dial]**). **[Protect]** is displayed.
- To cancel protection, choose **[OFF]**. **[Protect]** is no longer displayed.



Protected images on a memory card will be erased if you format the card (169).



Protected images cannot be erased using the camera's erasure function. To erase them this way, first cancel protection.

## Using the Menu

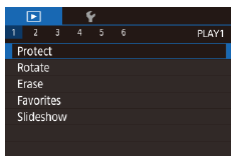

### 1 Access the setting screen.

- Press the **[MENU]** button and choose **[Protect]** on the **[1]** tab (130).

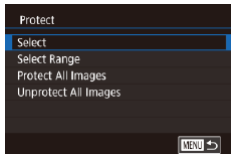

### 2 Choose a selection method.

- Choose an option as desired (130).
- To return to the menu screen, press the **[MENU]** button.

## Choosing Images Individually

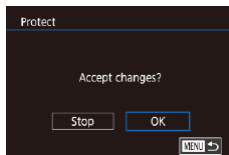

### 1 Choose **[Select]**.

- Following the procedure in “Using the Menu” (121), choose **[Select]** and press the **[MENU]** button.

### 2 Choose an image.

- Press the **[Left]**/**[Right]** buttons or turn the **[Dial]** to choose an image, and then press the **[MENU]** button. **[Protect]** is displayed.
- To cancel selection, press the **[MENU]** button again. **[Protect]** is no longer displayed.
- Repeat this process to specify other images.

### 3 Protect the image.

- Press the **[MENU]** button. A confirmation message is displayed.
- Press the **[Left]**/**[Right]** buttons or turn the **[Dial]** to choose **[OK]**, and then press the **[MENU]** button.



Images will not be protected if you switch to Shooting mode or turn the camera off before finishing the setup process in step 3.



- You can also select or clear images by touching the screen in step 2, and you can access the confirmation screen by touching **[MENU]**.
- You can also protect images by touching **[OK]** on the screen in step 3.

Before Use

Basic Guide

Advanced Guide

Camera Basics

Auto Mode / Hybrid Auto Mode

Other Shooting Modes

P Mode

Tv, Av, M, and C Mode

Playback Mode

Wi-Fi Functions

Setting Menu

Accessories

Appendix

Index



## Selecting a Range

### 1 Choose [Select Range].

- Following the procedure in “Using the Menu” (121), choose [Select Range] and press the  $\left[\text{SET}\right]$  button.

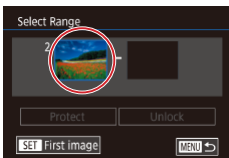

### 2 Choose a starting image.

- Press the  $\left[\text{SET}\right]$  button.



- Press the  $\left[\leftarrow\right]$ / $\left[\rightarrow\right]$  buttons or turn the  $\left[\text{DIAL}\right]$  to choose an image, and then press the  $\left[\text{SET}\right]$  button.

### 3 Choose an ending image.

- Press the  $\left[\rightarrow\right]$  button to choose [Last image], and then press the  $\left[\text{SET}\right]$  button.

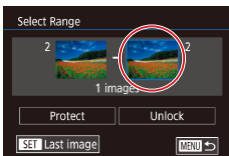

- Press the  $\left[\leftarrow\right]$ / $\left[\rightarrow\right]$  buttons or turn the  $\left[\text{DIAL}\right]$  to choose an image, and then press the  $\left[\text{SET}\right]$  button.
- Images before the first image cannot be selected as the last image.

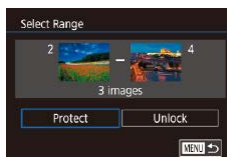

### 4 Protect the images.

- Press the  $\left[\blacktriangledown\right]$  button to choose [Protect], and then press the  $\left[\text{SET}\right]$  button.



- You can also choose the first or last image by turning the  $\left[\text{DIAL}\right]$  dial when the top screen in steps 2 and 3 is displayed.
- To cancel protection for groups of images, choose [Unlock] in step 4.



- You can also display the screen for choosing the first or last image by touching an image on the top screen in steps 2 or 3.
- You can also protect images by touching [Protect] on the screen in step 4.

## Protecting All Images at Once

### 1 Choose [Protect All Images].

- Following the procedure in “Using the Menu” (121), choose [Protect All Images] and press the  $\left[\text{SET}\right]$  button.

### 2 Protect the images.

- Press the  $\left[\leftarrow\right]$ / $\left[\rightarrow\right]$  buttons or turn the  $\left[\text{DIAL}\right]$  to choose [OK], and then press the  $\left[\text{SET}\right]$  button.

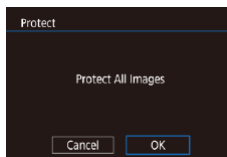

Before Use

Basic Guide

Advanced Guide

Camera Basics

Auto Mode /  
Hybrid Auto Mode

Other Shooting Modes

P Mode

Tv, Av, M, and C Mode

Playback Mode

Wi-Fi Functions

Setting Menu

Accessories

Appendix

Index



## Clearing All Protection at Once

You can clear protection from all images at once. To clear protection, choose [Unprotect All Images] in step 1 of “Protecting All Images at Once”, and then complete step 2.

## Erasing Images

▶ Still Images ▶ Movies

You can choose and erase unneeded images one by one. Be careful when erasing images, because they cannot be recovered. However, protected images (📖 121) cannot be erased.

### 1 Choose an image to erase.

- Press the [◀][▶] buttons or turn the [🔍] dial to choose an image.

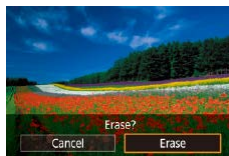

### 2 Erase the image.

- Press the [🗑️] button.
- After [Erase?] is displayed, press the [◀][▶] buttons or turn the [🔍] dial to choose [Erase], and then press the [🔍] button.
- The current image is now erased.
- To cancel erasure, press the [◀][▶] buttons or turn the [🔍] dial to choose [Cancel], and then press the [🔍] button.



- For images captured in both RAW and JPEG format, pressing the [🗑️] button while the image is displayed gives you the option of choosing [Erase RAW], [Erase JPEG], or [Erase RAW+JPEG].



- You can also erase the current image by touching [Erase] on the screen in step 2.
- Images can also be erased by using Touch Actions (📖 127).

Before Use

Basic Guide

Advanced Guide

Camera Basics

Auto Mode /  
Hybrid Auto Mode

Other Shooting Modes

P Mode

Tv, Av, M, and C Mode

Playback Mode

Wi-Fi Functions

Setting Menu

Accessories

Appendix

Index



## Erasing Multiple Images at Once

You can choose multiple images to erase at once. Be careful when erasing images, because they cannot be recovered. However, protected images (📖121) cannot be erased.

### Choosing a Selection Method

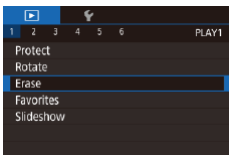

#### 1 Access the setting screen.

- Press the [MENU] button, and then choose [Erase] on the [1] tab (📖30).

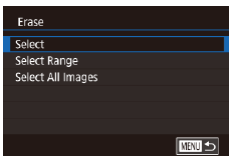

#### 2 Choose a selection method.

- Press the [▲][▼] buttons or turn the [DISP] dial to choose a selection method, and then press the [DISP] button.
- To return to the menu screen, press the [MENU] button.

## Choosing Images Individually

#### 1 Choose [Select].

- Following the procedure in “Choosing a Selection Method” (📖124), choose [Select] and press the [DISP] button.



#### 2 Choose an image.

- Once you choose an image following step 2 in “Choosing Images Individually” (📖121), [✓] is displayed.
- To cancel selection, press the [DISP] button again. [✓] is no longer displayed.
- Repeat this process to specify other images.

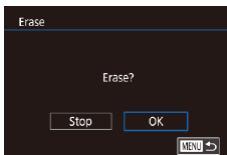

#### 3 Erase the images.

- Press the [MENU] button. A confirmation message is displayed.
- Press the [◀][▶] buttons or turn the [DISP] dial to choose [OK], and then press the [DISP] button.



- Choosing an image captured in both RAW and JPEG format will erase both versions.

Before Use

Basic Guide

Advanced Guide

Camera Basics

Auto Mode /  
Hybrid Auto Mode

Other Shooting Modes

P Mode

Tv, Av, M, and C Mode

Playback Mode

Wi-Fi Functions

Setting Menu

Accessories

Appendix

Index





## Selecting a Range

### 1 Choose [Select Range].

- Following the procedure in “Choosing a Selection Method” (124), choose [Select Range] and press the  button.

### 2 Choose images.

- Follow steps 2 – 3 in “Selecting a Range” (122) to specify images.

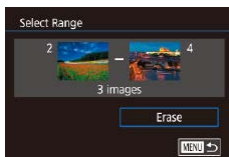

### 3 Erase the images.





- Press the  button to choose [Erase], and then press the  button.

## Specifying All Images at Once

### 1 Choose [Select All Images].

- Following the procedure in “Choosing a Selection Method” (124), choose [Select All Images] and press the  button.

### 2 Erase the images.

- Press the  or  buttons or turn the  dial to choose [OK], and then press the  button.

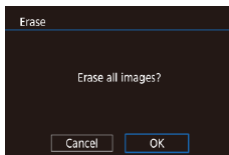

## Rotating Images

▶ Still Images ▶ Movies

Change the orientation of images and save them as follows.

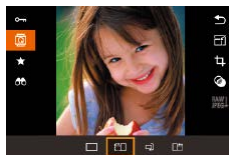

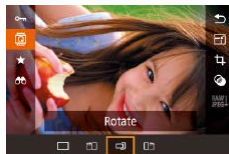

### 1 Choose [Q].

- Press the  button, and then choose  in the menu (129).



### 2 Rotate the image.

- Press the  or  button, depending on the desired direction. Each time you press the button, the image is rotated 90°. Press the  button to complete the setting.



- Rotation is not possible when [Auto Rotate] is set to [Off] (126).

## Using the Menu

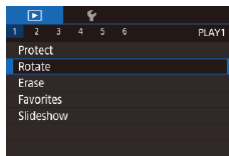

### 1 Choose [Rotate].

- Press the  button and choose [Rotate] on the  tab (130).

Before Use

Basic Guide

Advanced Guide

Camera Basics

Auto Mode /  
Hybrid Auto Mode

Other Shooting Modes

P Mode

Tv, Av, M, and C Mode

Playback Mode

Wi-Fi Functions

Setting Menu

Accessories

Appendix

Index



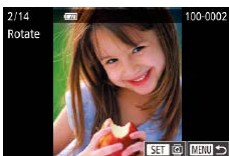

## 2 Rotate the image.

- Press the [◀][▶] buttons or turn the [DISP] dial to choose an image.
- The image is rotated 90° each time you press the [DISP] button.
- To return to the menu screen, press the [MENU] button.



- On the screen in step 2, you can also touch [SET] to rotate images or touch [MENU] to return to the menu screen.

## Deactivating Auto Rotation

Follow these steps to deactivate automatic image rotation, which rotates images based on the current camera orientation.

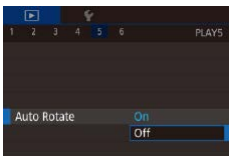

- Press the [MENU] button, choose [Auto Rotate] on the [▶]5 tab, and then choose [Off] (130).



- Images cannot be rotated (125) when you set [Auto Rotate] to [Off]. Additionally, images already rotated will be displayed in the original orientation.

## Tagging Images as Favorites

▶ Still Images ▶ Movies

You can organize images by tagging them as favorites. By choosing a category in filtered playback, you can restrict the following operations to all of those images.

- “Viewing” (110), “Viewing Slideshows” (120), “Protecting Images” (121), “Erasing Images” (123), “Adding Images to the Print List (DPOF)” (187), “Adding Images to a Photobook” (190)

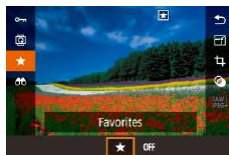

- Press the [DISP] button, and then choose [★] in the menu (29).
- To untag the image, repeat this process and choose [OFF], and then press the [DISP] button.

## Using the Menu

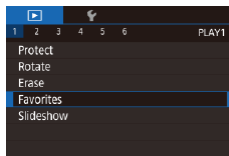

### 1 Choose [Favorites].

- Press the [MENU] button and choose [Favorites] on the [▶]1 tab (130).

### 2 Choose an image.

- Press the [◀][▶] buttons or turn the [DISP] dial to choose an image, and then press the [DISP] button. [★] is displayed.
- To untag the image, press the [DISP] button again. [★] is no longer displayed.
- Repeat this process to choose additional images.

Before Use

Basic Guide

Advanced Guide

Camera Basics

Auto Mode /  
Hybrid Auto Mode

Other Shooting Modes

P Mode

Tv, Av, M, and C Mode

Playback Mode

Wi-Fi Functions

Setting Menu

Accessories

Appendix

Index



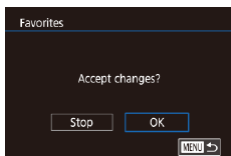

### 3 Complete the setting.

- Press the [MENU] button. A confirmation message is displayed.
- Press the [◀][▶] buttons or turn the [DISP] dial to choose [OK], and then press the [MENU] button.



- Images will not be tagged as favorites if you switch to Shooting mode or turn the camera off before finishing the setup process in step 3.



- Tagging images as favorites makes it easier to add them when creating albums (136).



- You can also select or clear current images by touching the screen in step 2.
- Images can also be tagged as favorites by using Touch Actions (127).

## Convenient Control: Touch Actions

▶ Still Images ▶ Movies

You can quickly and easily activate functions that you have assigned to four touch gestures (Touch Actions), in single-image display.

### Using Touch Actions Functions

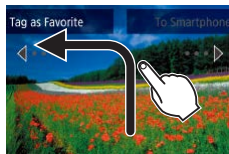

- Drag across the screen as shown.
- The function assigned to [↵] is now activated.

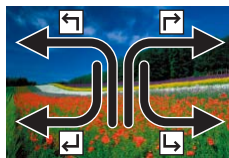

- Similarly, you can also activate functions assigned to [↶], [↷], and [↵] by dragging across the screen.
- Customize functions assigned to Touch Actions as desired.

### Changing Touch Actions Functions

Simplify your preferred camera operations by reassigning dragging patterns to them as desired.

#### 1 Access the setting screen.

- Press the [MENU] button, and then choose [Set Touch Actions] on the [6] tab (30).

Before Use

Basic Guide

Advanced Guide

Camera Basics

Auto Mode /  
Hybrid Auto Mode

Other Shooting Modes

P Mode

Tv, Av, M, and C Mode

Playback Mode

Wi-Fi Functions

Setting Menu

Accessories

Appendix

Index



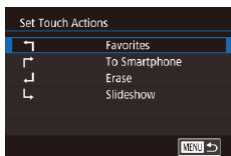

## 2 Assign a function to a Touch Action.

- Press the [▲][▼] buttons or turn the [DISP] dial to choose a dragging pattern, and then press the [SET] button.
- Press the [▲][▼] buttons or turn the [DISP] dial to choose a function to assign.

## Assignable Functions

Slideshow	Start a slideshow.
Erase	Erase an image.
Protect	Protect an image or cancel protection.
Rotate	Rotate an image.
Favorites	Tag images as favorites, or untag the image.
Next Favorite	Switch to displaying the next image tagged as a favorite.
Previous Favorite	Switch to displaying the previous image tagged as a favorite.
Next Date	Switch to displaying the first image with the next shooting date.
Previous Date	Switch to displaying the first image with the previous shooting date.
To Camera	
To Smartphone	Access the Wi-Fi connection screen.
To Computer	For Wi-Fi details, see "Wi-Fi Functions"
To Printer	(141).
To Web Service	

## Editing Still Images



- Image editing (128 – 131) is only available when the memory card has sufficient free space.



- You can access editing screens for various functions by touching an image after choosing the function in the menu.
- When [MENU] is shown on an editing screen, you can touch [MENU] instead of pressing the [MENU] button, if you prefer.
- When [SET] is shown on an editing screen, you can touch [SET] instead of pressing the [SET] button, if you prefer.

## Resizing Images

▶ Still Images ▶ Movies

Save a copy of images at a lower number of recording pixels.

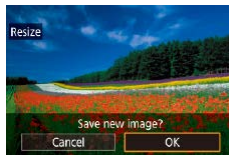

### 1 Choose an image size.

- Press the [DISP] button, choose [F] in the menu, and choose an image size (29).
- Press the [DISP] button.

### 2 Save the new image.

- After [Save new image?] is displayed, press the [◀][▶] buttons or turn the [DISP] dial to choose [OK], and then press the [DISP] button.
- The image is now saved as a new file.

Before Use

Basic Guide

Advanced Guide

Camera Basics

Auto Mode / Hybrid Auto Mode

Other Shooting Modes

P Mode

Tv, Av, M, and C Mode

Playback Mode

Wi-Fi Functions

Setting Menu

Accessories

Appendix

Index



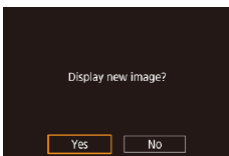

### 3 Review the new image.

- Press the [◀][▶] buttons or turn the [DISP] dial to choose [Yes], and then press the [SET] button.
- The saved image is now displayed.



- Editing is not possible for images shot at a recording pixel setting of [S2].
- RAW images cannot be edited.



- Images cannot be resized to a higher number of recording pixels.



- You can also view saved images by touching [Yes] on the screen in step 3.

## Using the Menu

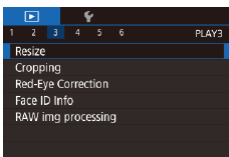

### 1 Choose [Resize].

- Press the [MENU] button and choose [Resize] on the [▶]3 tab (128).

### 2 Choose an image.

- Press the [◀][▶] buttons or turn the [DISP] dial to choose an image, and then press the [SET] button.

### 3 Choose an image size.

- Press the [◀][▶] buttons or turn the [DISP] dial to choose the size, and then press the [SET] button.



### 4 Save as a new image and review.

- Follow step 2 in “Resizing Images” (128).
- Press the [MENU] button and follow step 3 in “Resizing Images” (128).

## Cropping

▶ Still Images ▶ Movies

You can specify a portion of an image to save as a separate image file.



### 1 Access the setting screen.

- Press the [MENU] button, choose [C] in the menu, and then press the [SET] button (129).

### 2 Resize, move, and adjust the aspect ratio of the cropping frame.

- To resize the frame, move the zoom lever.
- To move the frame, press the [▲][▼][◀][▶] buttons.
- To change the frame orientation, turn the [DISP] dial to choose [C], and then press the [SET] button.
- To change the frame aspect ratio, turn the [DISP] dial to choose [C]. To switch between aspect ratios ([3:2], [16:9], [4:3], and [1:1]), press the [SET] button repeatedly.

Before Use

Basic Guide

Advanced Guide

Camera Basics

Auto Mode / Hybrid Auto Mode

Other Shooting Modes

P Mode

Tv, Av, M, and C Mode

Playback Mode

Wi-Fi Functions

Setting Menu

Accessories

Appendix

Index



### 3 Preview the cropped image.

- Turn the [DISP] dial to choose [C].
- To switch display between the cropped image and the cropping frame, press the [DISP] button repeatedly.

### 4 Save as a new image and review.

- Turn the [DISP] dial to choose [L], and then press the [DISP] button.
- Follow steps 2 – 3 in “Resizing Images” (p. 128).



- Editing is not possible for images shot at a recording pixel setting of [S2] or resized to [S2] (p. 128).
- RAW images cannot be edited.
- Cropped images cannot be cropped again.
- Cropped images cannot be resized or have Creative filters applied.



- Cropped images will have a lower number of recording pixels than uncropped images.
- While previewing the cropped image in step 3, you can resize, move, and adjust the aspect ratio of the cropping frame.
- Operations in step 2 are also possible by pressing the [MENU] button, choosing [3] tab ▶ [Cropping], pressing the [DISP] button, choosing an image, and pressing the [DISP] button again.
- If you crop still images shot using Face ID (p. 45), only the names of the people left in the cropped image will remain.



- You can also move the cropping frame in step 2 by dragging it. You can also resize frames by pinching in or out (p. 120) on the screen.
- Operations are also possible by touching [C], [L], [R], and [L] on the top of the screen in step 2.

## Applying Filter Effects

Apply effects equivalent to shooting in [L], [M], [S], [K], [C], [O], and [F] modes to images and save them as separate images.

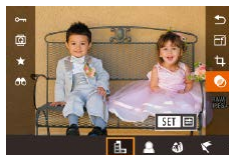

### 1 Choose an effect.

- Press the [DISP] button, choose [C] in the menu, and then choose the effect (p. 29).
- Press the [DISP] button.

### 2 Adjust the effect as needed.

- [L]: Press the [L/R] buttons to adjust contrast.
- [M]: Press the [L/R] buttons to adjust defocusing.
- [S] or [K]: Press the [L/R] buttons to adjust the level of the effect.
- [C]: Press the [L/R] buttons to adjust color saturation.
- [O]: Press the [L/R] buttons to adjust color tone.
- [F]: Move the zoom lever to resize the frame, and turn the [DISP] dial to move it.

### 3 Save as a new image and review.

- Press the [DISP] button.
- Follow steps 2 – 3 in “Resizing Images” (p. 128).

Before Use

Basic Guide

Advanced Guide

Camera Basics

Auto Mode / Hybrid Auto Mode

Other Shooting Modes

P Mode

Tv, Av, M, and C Mode

Playback Mode

Wi-Fi Functions

Setting Menu

Accessories

Appendix

Index





- [Red-Eye Correction]: To switch the orientation of the frame to vertical, press the [Left][Right] buttons on the screen in step 2. To move the frame, press the [Left][Right] buttons again. To return the frame to horizontal orientation, press the [Up][Down] buttons.
- The same operations are available by pressing the [MENU] button and choosing [2] tab ▶ [Creative filters], choosing an image, and pressing the [Red-Eye Correction] button.



- You can also adjust the effect by touching or dragging the bar on the bottom of the screen in step 2. For [Red-Eye Correction], you can also move the frame by touching or dragging across the screen.

## Correcting Red-Eye

▶ Still Images ▶ Movies

Automatically corrects images affected by red-eye. You can save the corrected image as a separate file.

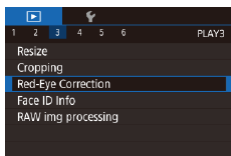

### 1 Choose [Red-Eye Correction].

- Press the [MENU] button, and then choose [Red-Eye Correction] on the [2] tab (130).

### 2 Choose an image.

- Press the [Left][Right] buttons or turn the [Dial] to choose an image.

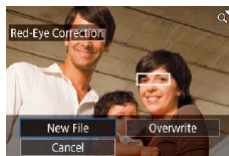

### 3 Correct the image.

- Press the [Red-Eye Correction] button.
- Red-eye detected by the camera is now corrected, and frames are displayed around corrected image areas.
- Enlarge or reduce images as needed. Follow the steps in "Magnifying Images" (119).

### 4 Save as a new image and review.

- Press the [Up][Down][Left][Right] buttons or turn the [Dial] to choose [New File], and then press the [Red-Eye Correction] button.
- The image is now saved as a new file.
- Press the [MENU] button and follow step 3 in "Resizing Images" (128).



- Some images may not be corrected accurately.
- To overwrite the original image with the corrected image, choose [Overwrite] in step 4. In this case, the original image will be erased.
- Protected images cannot be overwritten.
- RAW images cannot be edited this way.
- Red-eye correction can be applied to JPEG images also captured in RAW format, but the original image cannot be overwritten.



- You can also save images by touching [New File] or [Overwrite] on the screen in step 4.

Before Use

Basic Guide

Advanced Guide

Camera Basics

Auto Mode / Hybrid Auto Mode

Other Shooting Modes

P Mode

Tv, Av, M, and C Mode

Playback Mode

Wi-Fi Functions

Setting Menu

Accessories

Appendix

Index





# Processing RAW Images on the Camera

▶ Still Images ▶ Movies

You can process RAW images on the camera. Save RAW images as JPEG images while leaving the originals.

## 1 Choose a RAW image.

- Press the [◀][▶] buttons or turn the [DISP.] dial to choose a RAW image.



## 2 Access the setting screen.

- Press the [DISP.] button to choose [RAW] in the menu, and then choose the desired option, either by pressing the [◀][▶] buttons or turning the [DISP.] dial.
- If you chose [RAW], go to step 3.



## 3 Configure the processing method.

- If you chose [RAW], press the [DISP.] button, press the [▲][▼][◀][▶] buttons to choose an option, and then press the [DISP.] button.

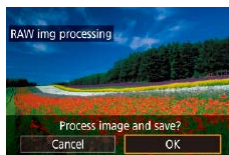

## 4 Configure advanced settings.

- Press the [◀][▶] buttons or turn the [DISP.] dial to choose the effect, and then press the [DISP.] button to return to the screen in step 3.



## 5 Save the settings.

- If you chose [RAW], press the [▲][▼][◀][▶] buttons to choose [RAW], press the [DISP.] button, press the [◀][▶] buttons or turn the [DISP.] dial to choose [OK], and then press the [DISP.] button.
- If you chose [RAW], press the [◀][▶] buttons or turn the [DISP.] dial to choose [OK], and then press the [DISP.] button.

Brightness adjustment	Adjust brightness.
White Balance	Choose the white balance.
Picture Style	Choose a Picture Style type.
Auto Lighting Optimizer	Configure the Auto Lighting Optimizer settings.
High ISO speed NR	Configure the noise reduction settings.
Image quality	Configure the image quality when creating JPEG images.



- You can also choose an effect for each option by turning the [DISP.] dial while an option is selected on the screen in step 3.
- Moving the zoom lever toward [Q] on the screen in step 3 will zoom in and magnify the image.
- To compare the image with the shot image, press the [MENU] button, and then turn the [DISP.] dial on the screen in step 3. To return to the setting screen, press the [MENU] button.
- To revert to the settings used for shooting, press the [RECALL] button on the screen in step 3.
- For functions with [INFO] displayed on the screen in step 4, you can configure more advanced settings by pressing the [▼] button.

Before Use

Basic Guide

Advanced Guide

Camera Basics

Auto Mode / Hybrid Auto Mode

Other Shooting Modes

P Mode

Tv, Av, M, and C Mode

Playback Mode

Wi-Fi Functions

Setting Menu

Accessories

Appendix

Index





## Using the Menu

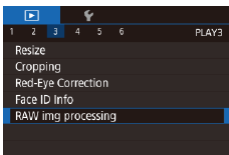

### 1 Access the setting screen.

- Press the [MENU] button, and then choose the [3] tab ► [RAW img processing] (132).

### 2 Choose a selection method.

- Choose the desired option (30).
- To return to the menu screen, press the [MENU] button.

## Choosing Images Individually

### 1 Choose [Select].

- Following the procedure in “Using the Menu” (133), choose [Select] and press the [Select] button.

### 2 Choose an image.

- Once you choose an image following step 2 in “Choosing Images Individually” (121), [✓] is displayed.
- To deselect the image, press the [Select] button again. [✓] is no longer displayed.
- Repeat this process to specify other images.
- Press the [MENU] button to go to the setting screen.



### 3 Process the images.

- Follow steps 2 – 5 in “Processing RAW Images on the Camera” (132) to process images.

## Selecting a Range

### 1 Choose [Select Range].

- Follow the procedure in “Using the Menu” (129) to choose [Select Range], and then press the [Select] button.

### 2 Choose images.

- Follow steps 2 – 3 in “Selecting a Range” (122) to choose images.

### 3 Process the images.

- Follow steps 2 – 5 in “Processing RAW Images on the Camera” (132) to process images.



- Images processed on the camera and the ones processed using Digital Photo Professional will not be exactly the same.



- Up to 500 images can be chosen at a time.
- To choose the processing method from the menu, press the [▲][▼] buttons to choose the desired option in step 3.

Before Use

Basic Guide

Advanced Guide

Camera Basics

Auto Mode /  
Hybrid Auto Mode

Other Shooting Modes

P Mode

Tv, Av, M, and C Mode

Playback Mode

Wi-Fi Functions

Setting Menu

Accessories

Appendix

Index



# Editing Movies

▶ Still Images ▶ Movies

You can remove unneeded portions from the beginning and end of movies.

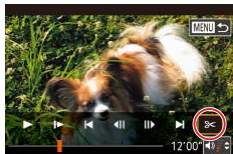

## 1 Choose [C].

- Following steps 1 – 5 in “Viewing” (110), choose [C] and press the [OK] button.
- The movie editing panel and editing bar are now displayed.

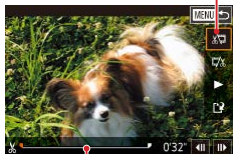

(2)

## 2 Specify portions to cut.

- (1) is the movie editing panel, and (2) is the editing bar.
- Press the [▲][▼] buttons to choose [L] or [R].
- To specify a portion to cut (indicated by [L]), press the [◀][▶] buttons or turn the [DISC] dial to move the orange [L] or [R] icon. Cut the beginning of the movie (from [L]) by choosing [L], and cut the end of the movie by choosing [R].
- If you move [L] or [R] to a position other than a [L] mark, in [L] the portion before the nearest [L] mark on the left will be cut, while in [R] the portion after the nearest [L] mark on the right will be cut.

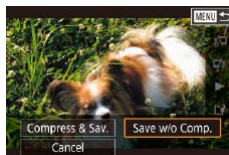
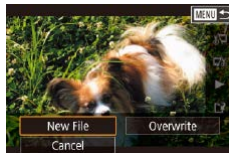

## 3 Review the edited movie.

- Press the [▲][▼] buttons to choose [▶], and then press the [DISC] button. The edited movie is now played.
- To edit the movie again, repeat step 2.
- To cancel editing, press the [MENU] button, choose [OK] (either press the [◀][▶] buttons or turn the [DISC] dial), and then press the [DISC] button.

## 4 Save the edited movie.

- Press the [▲][▼] buttons to choose [L], and then press the [DISC] button.
- Press the [▲][▼][◀][▶] buttons or turn the [DISC] dial to choose [New File], and then press the [DISC] button.
- Choose [Save w/o Comp.], and then press the [DISC] button.
- The movie is now saved as a new file.



- To overwrite the original movie with the cut one, choose [Overwrite] in step 4. In this case, the original movie will be erased.
- If the memory card lacks sufficient space, only [Overwrite] will be available.
- Movies may not be saved if the battery pack runs out while saving is in progress.
- Using a fully charged battery pack is recommended when editing movies.



- You can also edit movies by touching the movie editing panel or editing bar.

Before Use

Basic Guide

Advanced Guide

Camera Basics

Auto Mode / Hybrid Auto Mode

Other Shooting Modes

P Mode

Tv, Av, M, and C Mode

Playback Mode

Wi-Fi Functions

Setting Menu

Accessories

Appendix

Index



## Reducing File Sizes

Movie file sizes can be reduced by compressing movies as follows.

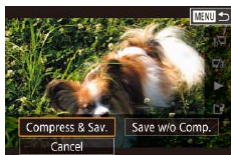

- On the screen in step 2 of “Editing Movies”, choose [M]. Choose [New File], and then press the [MENU] button.
- Choose [Compress & Sav.], and then press the [MENU] button.

### Image Quality of Compressed Movies

Before Compression	After Compression
[FHD 59.94P], [FHD 29.97P]	[FHD 29.97P]
[FHD 23.98P]	[FHD 23.98P]
[FHD 50.00P], [FHD 25.00P]	[FHD 25.00P]



- [VGA 29.97P], [VGA 25.00P] movies cannot be compressed.
- Edited movies cannot be saved in compressed format when you choose [Overwrite].
- Compressing movies to [FHD 29.97P] or [FHD 25.00P] reduces the file size while maintaining the same image quality.

## Editing Short Movies

▶ Still Images ▶ Movies

Individual chapters (clips) (136) recorded in [M] mode can be erased, as needed. Erased chapters cannot be recovered. Be sure that you want to erase the chapters before using this option.



### 1 Select the clip to erase.

- Follow steps 1 – 2 in “Viewing Short Movies Created When Shooting Still Images (Digest Movies)” (114) to play a short movie, and press the [MENU] button to access the movie control panel.
- Press the [◀][▶] buttons or turn the [DIAL] dial to choose [◀] or [▶], and then press the [MENU] button to choose a clip.

### 2 Choose [M].

- Press the [◀][▶] buttons or turn the [DIAL] dial to choose [M], and then press the [MENU] button.
- The selected clip is played back repeatedly.

### 3 Confirm erasure.

- Press the [◀][▶] buttons or turn the [DIAL] dial to choose [OK], and then press the [MENU] button.
- The clip is erased, and the short movie is overwritten.

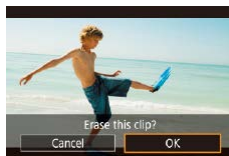

- [M] is not displayed if you select a clip when the camera is connected to a printer.

Before Use

Basic Guide

Advanced Guide

Camera Basics

Auto Mode / Hybrid Auto Mode

Other Shooting Modes

P Mode

Tv, Av, M, and C Mode

Playback Mode

Wi-Fi Functions

Setting Menu

Accessories

Appendix

Index



## Viewing Albums (Story Highlights)

▶ Still Images ▶ Movies

You can choose themes such as a date or person's name to create an album of automatically selected images that match the theme. These images are combined into a slideshow that can be saved as a short movie of about 2 – 3 minutes.

Before using this feature, make sure the battery pack is fully charged. Creating albums also requires free space on the memory card. As a guideline, use a memory card with a capacity of 16 GB or higher, and ensure at least 1 GB of free space.

### Choosing Themes for Albums

Press the [▲] button to access the home screen and choose the theme for the camera to use when selecting album elements. Note that the camera is more likely to add images tagged as favorites (📖 126) to albums.

Date	Creates an album of images shot on the same day. Images are selected from those shot on the same day as the image displayed before you access the home screen.
Person's name	Can be used to create monthly albums of people, such as albums of children as they grow up. Subjects whose Face ID information you registered before shooting may be selected for albums. Images selected are those that have the same subject shot during the same month as the image displayed before you access the home screen.
Event	A good choice for albums of vacations, parties, or other events. Images are selected from those shot during the event before and after the image displayed before you access the home screen.
Custom	Includes images based on your specified images, dates, or people registered in Face ID.

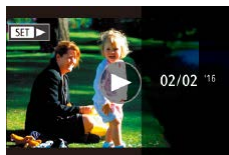
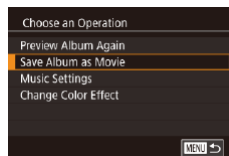
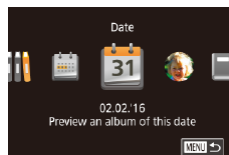

### 1 Choose an image.

- Choose an image in single-image display.
- Themes available in step 3 will vary depending on image shooting date and Face ID information.

### 2 Access the home screen.

- Press the [▲] button.
- After [Busy] is displayed, the home screen is displayed.

### 3 Preview an album.

- Press the [◀][▶] buttons to choose a person or [Date] or [Event] as the album theme, and then press the [📖] button.
- After [Loading] is displayed for a few seconds, the album is played.

### 4 Save the album.

- Press the [▲][▼] buttons to choose [Save Album as Movie], and then press the [📖] button.
- Once the album is saved, [Saved] is displayed.

### 5 Play the album (📖 110).

Before Use

Basic Guide

Advanced Guide

Camera Basics

Auto Mode /  
Hybrid Auto Mode

Other Shooting Modes

P Mode

Tv, Av, M, and C Mode

Playback Mode

Wi-Fi Functions

Setting Menu

Accessories

Appendix

Index





- Albums can include following images captured by the camera.
  - Still Images
  - Digest movies (📖36), except compressed movies
  - Short clips (📖74) of two seconds or longer, except compressed movies



- Albums cannot be saved unless there is enough space on the memory card.
- To jump to the next chapter during the preview, drag left, and to jump to the previous chapter, drag right.
- You can specify the color effect in step 4 by choosing [Change Color Effect] and pressing the [SET] button. To preview how the album looks with your selected effect applied, choose [Preview Album Again] on the screen in step 4 after pressing the [◀|▶] buttons to choose a color effect and pressing the [SET] button.
- To play saved albums, choose [List of Albums] on the Story Highlights home screen, press the [SET] button, choose a listed album, and press the [SET] button again.

## Adding Background Music to Albums

▶ Still Images ▶ Movies

Choose from seven kinds of background music to play during album playback.

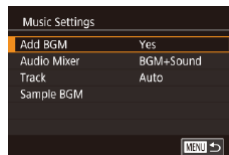

### 1 Register background music to a memory card.

- Following steps 1 – 4 in “Viewing Albums (Story Highlights)” (📖136), choose [Music Settings] and press the [SET] button.
- The screen at left is displayed when you use a new or recently formatted memory card. Choose [OK] (either press the [◀|▶] buttons or turn the [DIAL], press the [SET] button, and wait about four minutes until the seven types of music are registered to the card.
- When using a memory card with music already registered to it, go to step 2.

### 2 Create the album.

- Follow steps 1 – 3 in “Viewing Albums (Story Highlights)” (📖136) to create an album.

### 3 Configure background music settings.

- Choose the required item, press the [SET] button, and then choose an option (📖30).

### 4 Save the album.

- Follow step 4 in “Viewing Albums (Story Highlights)” (📖136) to save albums.

Before Use

Basic Guide

Advanced Guide

Camera Basics

Auto Mode / Hybrid Auto Mode

Other Shooting Modes

P Mode

Tv, Av, M, and C Mode

Playback Mode

Wi-Fi Functions

Setting Menu

Accessories

Appendix

Index





- Once albums are saved, background music cannot be added later. Background music in albums cannot be removed or changed.
- Chapters of albums with background music cannot be edited (p. 135).



- If you prefer not to add background music, set [Add BGM] to [No] on the screen in step 3.
- To use only background music instead of movie audio, set [Audio Mixer] to [BGM only] on the screen in step 3.
- To listen to a sample of the background music selected in [Track], choose [Sample BGM] on the screen in step 3 and press the button.

## Creating Your Own Albums

▶ Still Images ▶ Movies

Create your own albums by choosing desired images.

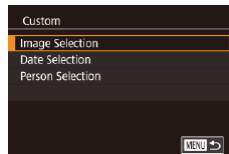

### 1 Choose to create a Custom album.

- Following steps 1 – 3 in “Viewing Albums (Story Highlights)” (p. 136), choose [Custom] and press the button.

### 2 Choose a selection method.

- Choose [Image Selection], [Date Selection], or [Person Selection], and then press the button.

### 3 Choose album elements.

- Once you select the elements for your album and press the , your selected elements are labeled with [✓].
- Press the [MENU] button after you finish selecting still images or short clips in [Image Selection], dates in [Date Selection], or people in [Person Selection].
- Press the [◀][▶] buttons or turn the dial to choose [Preview], and then press the button.

Before Use

Basic Guide

Advanced Guide

Camera Basics

Auto Mode /  
Hybrid Auto Mode

Other Shooting Modes

P Mode

Tv, Av, M, and C Mode

Playback Mode

Wi-Fi Functions

Setting Menu

Accessories

Appendix

Index



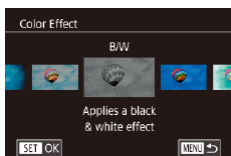
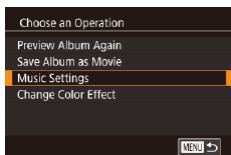

#### 4 Choose background music.

- When the screen at left is displayed, choose [Music Settings]. Add background music as described in “Adding Background Music to Albums” (137), and then press the [MENU] button.

#### 5 Choose a color effect.

- On the screen in step 4 of “Viewing Albums (Story Highlights)” (136), choose [Change Color Effect].
- Press the [◀][▶] buttons to choose a color effect, and then press the [SET] button.

#### 6 Save the album.

- Follow step 4 in “Viewing Albums (Story Highlights)” (136) to save albums.



- You can specify up to 40 files (or 10 movie files) after choosing [Image Selection]. From the second time you create a custom album, [Select images based on previous settings?] is displayed. If you choose [Yes], the previous still images or short clips are labeled with [✓], and multiple images are displayed at once.
- Up to 15 dates can be selected if you choose [Date Selection].

## Combining Short Clips

▶ Still Images ▶ Movies

Combine short clips to create a longer movie.  
Note that movies created this way are not included in Story Highlights albums (136).

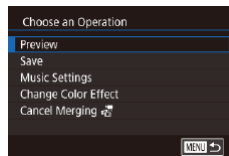
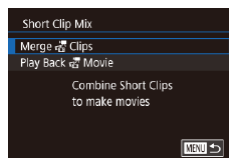

#### 1 Access the editing screen.

- Press the [MENU] button, choose [Short Clip Mix] on the [▶2] tab, and then choose [Merge Clips] (30).

#### 2 Specify clips to combine.

- Press the [◀][▶] buttons or turn the [DISP] dial to choose a clip to combine from the top of the screen, and then press the [SET] button.
- Your selected clip is displayed on the bottom of the screen.
- To cancel selection, press the [DISP] button again.
- Repeat these steps to specify other clips to combine.
- After you are finished selecting clips, press the [MENU] button.

#### 3 Preview the movie.

- Choose [Preview] and press the [DISP] button.
- After [Loading] is displayed for a few seconds, a preview of the combined clips is played.

Before Use

Basic Guide

Advanced Guide

Camera Basics

Auto Mode / Hybrid Auto Mode

Other Shooting Modes

P Mode

Tv, Av, M, and C Mode

Playback Mode

Wi-Fi Functions

Setting Menu

Accessories

Appendix

Index





#### 4 Save the movie.

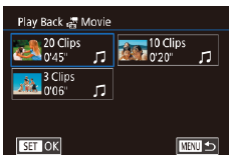







- Choose [Save], and then press the  button.
- Once the movie is saved, [Saved] is displayed.



#### 5 Play the movie.

- Choose [Play Back  Movie] on the screen in step 1 to view a list of movies you have created.
- Choose the movie to play and press the  button.



- From the second time you create a custom album, [Select images based on previous settings?] is displayed. If you choose [Yes], the editing screen is displayed with the short clips in the previously selected order.
- To play the selected clip, move the zoom lever toward  on the screen in step 2.
- To rearrange clips, press the  button on the screen in step 2, select a clip, press the  button, press the   buttons or turn the  dial, and then press the  button again.
- To apply a color effect, choose [Change Color Effect] on the screen in step 3.
- To add background music, choose [Music Settings] on the screen in step 3 ( 137).
- The image quality of movies saved is .
- Use a fully charged battery pack, if possible.

Before Use

Basic Guide

Advanced Guide

Camera Basics

Auto Mode /  
Hybrid Auto Mode

Other Shooting Modes

P Mode

Tv, Av, M, and C Mode

Playback Mode

Wi-Fi Functions

Setting Menu

Accessories

Appendix

Index





## Wi-Fi Functions

Send images wirelessly from the camera to a variety of compatible devices, and use the camera with Web services



- Before using Wi-Fi, be sure to read “Wi-Fi (Wireless LAN) Precautions” (p.224).

## Available Wi-Fi Features

You can send and receive images and control the camera remotely by connecting it to these devices and services via Wi-Fi.

- **Smartphones and Tablets**  
Send images to smartphones and tablet computers that have Wi-Fi functions. You can also shoot remotely and geotag your shots from a smartphone or tablet.  
For convenience in this manual, smartphones, tablets, and other compatible devices are collectively referred to as “smartphones”.
- **Computer**  
Use software to save camera images to a computer connected via Wi-Fi.
- **Web Services**  
Add your account information to the camera for CANON iMAGE GATEWAY online photography service or other Web services to send camera images to the services. Unsent images on the camera can also be sent to a computer or Web service via CANON iMAGE GATEWAY.
- **Printers**  
Send images wirelessly to a PictBridge-compatible printer (supporting DPS over IP) to print them.
- **Another Camera**  
Send images wirelessly between Wi-Fi-compatible Canon cameras.

Before Use

Basic Guide

Advanced Guide

Camera Basics

Auto Mode /  
Hybrid Auto Mode

Other Shooting Modes

P Mode

Tv, Av, M, and C Mode

Playback Mode

Wi-Fi Functions

Setting Menu

Accessories

Appendix

Index



## Sending Images to a Smartphone

There are several ways to connect the camera to a smartphone and send images.

- Connect via NFC (📖142)  
Simply touch an NFC-compatible Android smartphone (OS version 4.0 or later) against the camera to connect the devices.
- Connect via the Wi-Fi menu (📖144)  
You can connect the camera to a smartphone as you would connect it to a computer or other device. Multiple smartphones can be added.

Before connecting to the camera, you must install the free dedicated Camera Connect app on the smartphone. For details on this application (supported smartphones and included functions), refer to the Canon website.



- Canon Wi-Fi-compatible camera owners who use CameraWindow to connect their camera via Wi-Fi to a smartphone should consider switching to the Camera Connect mobile app.

## Sending Images to an NFC-Compatible Smartphone

Use an Android (OS version 4.0 or later) smartphone's NFC to simplify the process of installing Camera Connect and connecting to the camera. Operation when devices are initially connected via NFC varies depending on the camera mode when the devices are touched together.

- If the camera is off or in Shooting mode when the devices are touched together, you can choose and send images on the image selection screen. Once the devices are connected, you can also shoot remotely and geotag your shots (📖164). It is easy to reconnect to recent devices, which are listed in the Wi-Fi menu.
- If the camera is in Playback mode when the devices are touched together, you can choose and send images from the index display shown for image selection.

Follow the instructions in the following section for NFC-initiated connection to a camera that is off or in Shooting mode.

### Connecting via NFC When Camera Is Off or in Shooting Mode

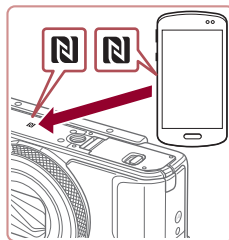

#### 1 Install Camera Connect.

- Activate NFC on the smartphone and touch the devices' N-Marks (N) together to start Google Play on the smartphone automatically. Once the Camera Connect download page is displayed, download and install the app.

Before Use

Basic Guide

Advanced Guide

Camera Basics

Auto Mode /  
Hybrid Auto Mode

Other Shooting Modes

P Mode

Tv, Av, M, and C Mode

Playback Mode

Wi-Fi Functions

Setting Menu

Accessories

Appendix

Index



## 2 Establish the connection.

- Make sure the camera is off or in Shooting mode.
- Touch the N-Mark (N) on the smartphone with Camera Connect installed against the camera's N-Mark.
- The camera screen automatically changes.
- If the [Device Nickname] screen is displayed, press the [▲][▼] buttons or turn the [DISP] dial to choose [OK], and then press the [SET] button.
- Camera Connect is started on the smartphone.
- The devices are connected automatically.

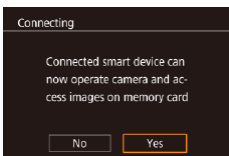
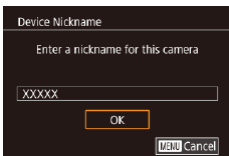

## 3 Adjust the privacy setting.

- When this screen is displayed, press the [◀][▶] buttons or turn the [DISP] dial to choose [Yes], and then press the [SET] button.
- You can now use the smartphone to browse, import, or geotag images on the camera or shoot remotely.

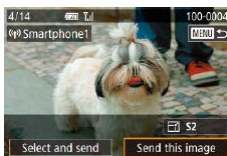

## 4 Send an image.

- Turn the [DISP] dial to choose an image to send, press the [◀][▶] buttons to choose [Send this image], and then press the [SET] button.
- [Transfer completed] is displayed after the image is sent, and the image transfer screen is displayed again.
- To end the connection, press the [MENU] button, choose [OK] on the confirmation screen (either press the [◀][▶] buttons or turn the [DISP] dial, and then press the [SET] button). You can also use the smartphone to end the connection.



- When using NFC, keep the following points in mind.
  - Avoid strong impact between the camera and smartphone. This may damage the devices.
  - Depending on the smartphone, the devices may not recognize each other immediately. In this case, try holding the devices together in slightly different positions. If connection is not established, keep the devices together until the camera screen is updated.
  - If you attempt connection when the camera is off, a message may be displayed on the smartphone reminding you to turn on the camera. If so, turn the camera on and touch the devices together again.
  - Do not place other objects between the camera and smartphone. Also, note that camera or smartphone covers or similar accessories may block communication.
- All images in the camera can be viewed from the connected smartphone when you choose [Yes] in step 3. To keep camera images private, so that they cannot be viewed from the smartphone, choose [No] in step 3.
- Once you have registered a smartphone, you can change privacy settings for it on the camera (165).

Before Use

Basic Guide

Advanced Guide

Camera Basics

Auto Mode /  
Hybrid Auto Mode

Other Shooting Modes

P Mode

Tv, Av, M, and C Mode

Playback Mode

Wi-Fi Functions

Setting Menu

Accessories

Appendix

Index





- Connections require that a memory card be in the camera.
- You can also change the camera nickname on the screen in step 2 (📖32).
- Not all NFC-compatible smartphones have an N-Mark (N). For details, refer to the smartphone user manual.
- You can also send multiple images at once and change the image size before sending (📖159).
- To disable NFC connections, choose MENU (📖30) ▶ [4] tab ▶ [Wireless settings] ▶ [Wi-Fi Settings] ▶ [NFC] ▶ [Off].

## Connecting via NFC When Camera Is in Playback Mode



- Press the [▶] button to turn the camera on.
- Touch the smartphone with Camera Connect installed (📖142) against the camera's N-Mark (N).
- Press the [▲][▼][◀][▶] buttons or turn the [DISP] dial to choose an image to send, and then press the [SEND] button. [✓] is displayed.
- To cancel selection, press the [SEND] button again. [✓] is no longer displayed.
- Repeat this process to choose additional images.
- After you finish choosing images, press the [MENU] button, choose [OK], and then press the [SEND] button.
- Press the [▲][▼][◀][▶] buttons or turn the [DISP] dial to choose [Send], and then press the [SEND] button.
- The images are now sent.



- If during connection a message on the camera requests you to enter the nickname, follow step 2 in "Connecting via NFC When Camera Is Off or in Shooting Mode" (📖142) to enter it.
- The camera does not keep a record of smartphones you connect to via NFC in Playback mode.
- You can preset images to transfer at your desired size (📖161).

## Adding a Smartphone

These steps show how to use the camera as an access point, but you can also use an existing access point (📖146).

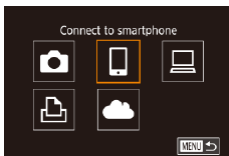
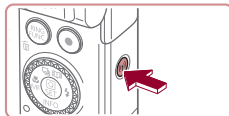

### 1 Install Camera Connect.

- For an iPhone or iPad, find Camera Connect in the App Store and download and install the app.
- For Android smartphones, find Camera Connect in Google Play and download and install the app.

### 2 Access the Wi-Fi menu.

- Press the [(W)] button.
- If the [Device Nickname] screen is displayed, choose [OK] (📖142).

### 3 Choose [ ].

- Press the [▲][▼][◀][▶] buttons or turn the [DISP] dial to choose [ ], and then press the [SEND] button.

Before Use

Basic Guide

Advanced Guide

Camera Basics

Auto Mode / Hybrid Auto Mode

Other Shooting Modes

P Mode

Tv, Av, M, and C Mode

Playback Mode

Wi-Fi Functions

Setting Menu

Accessories

Appendix

Index



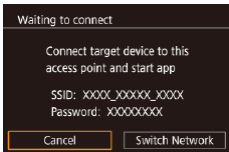
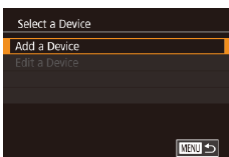

#### 4 Choose [Add a Device].

- Press the [▲][▼] buttons or turn the [DISP] dial to choose [Add a Device], and then press the [SET] button.

- The camera SSID and password are displayed.

#### 5 Connect the smartphone to the network.

- In the smartphone's Wi-Fi setting menu, choose the SSID (network name) displayed on the camera to establish a connection.
- In the password field, enter the password displayed on the camera.

#### 6 Start Camera Connect.

- Start Camera Connect on the smartphone.

#### 7 Select the camera to connect to.

- On the camera selection screen displayed on the smartphone, choose the camera to begin pairing.

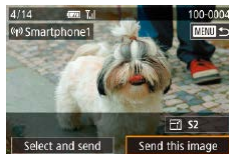
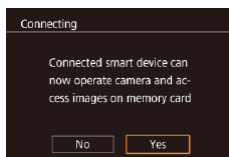

#### 8 Adjust the privacy setting.

- Press the [◀][▶] buttons or turn the [DISP] dial to choose [Yes], and then press the [SET] button.
- You can now use the smartphone to browse, import, or geotag images on the camera or shoot remotely.

#### 9 Send an image.

- Turn the [DISP] dial to choose an image to send, press the [◀][▶] buttons to choose [Send this image], and then press the [SET] button.
- [Transfer completed] is displayed after the image is sent, and the image transfer screen is displayed again.
- To end the connection, press the [MENU] button, choose [OK] on the confirmation screen (either press the [◀][▶] buttons or turn the [DISP] dial), and then press the [SET] button. You can also use the smartphone to end the connection.
- To add multiple smartphones, repeat the above procedure starting from step 1.



- All images in the camera can be viewed from the connected smartphone when you choose [Yes] in step 8. To keep camera images private, so that they cannot be viewed from the smartphone, choose [No] in step 8.
- Once you have registered a smartphone, you can change privacy settings for it on the camera (📖 165).

Before Use

Basic Guide

Advanced Guide

Camera Basics

Auto Mode / Hybrid Auto Mode

Other Shooting Modes

P Mode

Tv, Av, M, and C Mode

Playback Mode

Wi-Fi Functions

Setting Menu

Accessories

Appendix

Index





- Connections require that a memory card be in the camera.
- Once you have connected to devices via the Wi-Fi menu, recent connections will be listed first when you access the Wi-Fi menu. You can easily connect again by pressing the [▲][▼] buttons to choose the device and then pressing the [SET] button. To add a new device, display the device selection screen by pressing the [◀][▶] buttons, and then configure the setting.
- If you prefer not to display recent target devices, choose MENU (130) ▶ [4] tab ▶ [Wireless settings] ▶ [Wi-Fi Settings] ▶ [Target History] ▶ [Off].
- To connect without entering a password in step 5, choose MENU (130) ▶ [4] tab ▶ [Wireless settings] ▶ [Wi-Fi Settings] ▶ [Password] ▶ [Off]. [Password] will no longer be displayed on the SSID screen (in step 4).
- You can also send multiple images at once and change the image size before sending (159).

## Using Another Access Point

When connecting the camera to a smartphone through the Wi-Fi menu, you can also use an existing access point.

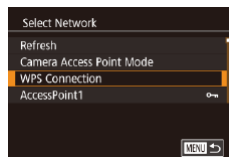
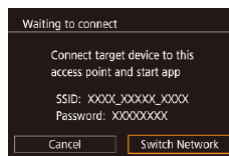

### 1 Prepare for the connection.

- Access the [Waiting to connect] screen by following steps 1 – 4 in “Adding a Smartphone” (144).

### 2 Connect the smartphone to the access point.

### 3 Choose [Switch Network].

- Press the [◀][▶] buttons or turn the [DIAL] dial to choose [Switch Network], and then press the [SET] button.
- A list of detected access points will be displayed.

### 4 Connect to the access point.

- For WPS-compatible access points, connect to the access point and choose the smartphone as described in steps 5 – 8 in “Using WPS-Compatible Access Points” (149).
- For non-WPS access points, follow steps 2 – 4 in “Connecting to Listed Access Points” (151) to connect to the access point and choose the smartphone.

### 5 Select the camera to connect to.

- On the camera selection screen displayed on the smartphone, choose the camera to begin pairing.

Before Use

Basic Guide

Advanced Guide

Camera Basics

Auto Mode / Hybrid Auto Mode

Other Shooting Modes

P Mode

Tv, Av, M, and C Mode

Playback Mode

Wi-Fi Functions

Setting Menu

Accessories

Appendix

Index



## 6 Configure the privacy settings and send images.

- Follow steps 8 – 9 in “Adding a Smartphone” (📖144) to configure the privacy settings and send images.

### ■ Previous Access Points

You can reconnect to any previous access points automatically by following step 4 in “Adding a Smartphone” (📖144).

- To use the camera as an access point, choose [Switch Network] on the screen displayed when you establish a connection, and then choose [Camera Access Point Mode].
- To switch access points, choose [Switch Network] on the screen displayed when you establish a connection, and then follow the procedure in “Using Another Access Point” (📖146) from step 4.

## Saving Images to a Computer

### ■ Preparing to Register a Computer

For detailed system requirements and compatibility information, such as computers that can be connected via Wi-Fi to the camera, including support for new operating systems, visit the Canon website.



- Windows 7 Starter and Home Basic editions are not supported.
- Windows 7 N (European version) and KN (South Korean version) require a separate download and installation of Windows Media Feature Pack.  
For details, check the following website.  
<http://go.microsoft.com/fwlink/?LinkId=159730>

### Installing the Software

Windows 7 and Mac OS X 10.9 are used here for the sake of illustration.

#### 1 Download the software.

- Visit the following site from a computer connected to the Internet.

<http://www.canon.com/icpd/>

- Choose your country or region, and then follow the instructions displayed to prepare for downloading.
- The compressed software is now downloaded to your computer.

Before Use

Basic Guide

Advanced Guide

Camera Basics

Auto Mode /  
Hybrid Auto Mode

Other Shooting Modes

P Mode

Tv, Av, M, and C Mode

Playback Mode

Wi-Fi Functions

Setting Menu

Accessories

Appendix

Index





## 2 Begin the installation.

- Double-click the downloaded file, and when the screen at left is displayed, click [Easy Installation]. Follow the on-screen instructions to complete the installation process.
- Installation may take some time, depending on computer performance and the Internet connection.
- Click [Finish] or [Restart] on the screen after installation.



- Internet access is required, and any ISP account charges and access fees must be paid separately.



- To uninstall the software, follow these steps.
  - Windows: Select [Start] menu ► [All Programs] ► [Canon Utilities], and then choose the software for uninstallation.
  - Mac OS: In the [Canon Utilities] folder within the [Applications] folder, drag the folder of the software for uninstallation to the Trash, and then empty the Trash.

## Configure the computer for a Wi-Fi connection (Windows only)

On a computer running Windows, configure the following settings before connecting the camera to the computer wirelessly.



### 1 Confirm that the computer is connected to an access point.

- For instructions on checking your network connection, refer to the computer user manual.

### 2 Configure the setting.

- Click in the following order: [Start] menu ► [All Programs] ► [Canon Utilities] ► [CameraWindow] ► [Wi-Fi connection setup].
- In the application that opens, follow the on-screen instructions and configure the setting.



- The following Windows settings are configured when you run the utility in step 2.
  - Turn on media streaming.  
This will enable the camera to see (find) the computer to access via Wi-Fi.
  - Turn on network discovery.  
This will enable the computer to see (find) the camera.
  - Turn on ICMP (Internet Control Message Protocol).  
This allows you to check the network connection status.
  - Enable Universal Plug & Play (UPnP).  
This will enable network devices to detect each other automatically.
- Some security software may prevent you from completing the settings as described here. Check the settings of your security software.

Before Use

Basic Guide

Advanced Guide

Camera Basics

Auto Mode /  
Hybrid Auto Mode

Other Shooting Modes

P Mode

Tv, Av, M, and C Mode

Playback Mode

Wi-Fi Functions

Setting Menu

Accessories

Appendix

Index





## Saving Images to a Connected Computer

Connect to your access point via Wi-Fi as follows.  
Also refer to the access point user manual.

### Confirming Access Point Compatibility

Confirm that the Wi-Fi router or base station conforms to the Wi-Fi standards in “Camera” (📖217).

Connection methods vary depending on whether the access point supports Wi-Fi Protected Setup (WPS, 📖149) or not (📖151). For non-WPS access points, check the following information.

- Network name (SSID/ESSID)  
The SSID or ESSID for the access point you use. Also called the “access point name” or “network name”.
- Network authentication / data encryption (encryption method / encryption mode)  
The method for encrypting data during wireless transmission. Check which security setting is used: WPA2-PSK (AES), WPA2-PSK (TKIP), WPA-PSK (AES), WPA-PSK (TKIP), WEP (open system authentication), or no security.
- Password (encryption key / network key)  
The key used when encrypting data during wireless transmission. Also called the “encryption key” or “network key”.
- Key index (transmit key)  
The key set when WEP is used for network authentication / data encryption. Use “1” as the setting.



- If system administrator status is needed to adjust network settings, contact the system administrator for details.
- These settings are very important for network security. Exercise adequate caution when changing these settings.



- For information on WPS compatibility and for instructions on checking settings, refer to the access point user manual.
- A router is a device that creates a network (LAN) structure for connecting multiple computers. A router that contains an internal Wi-Fi function is called a “Wi-Fi router”.
- This guide refers to all Wi-Fi routers and base stations as “access points”.
- If you use MAC address filtering on your Wi-Fi network, be sure to add the camera’s MAC address to your access point. You can check your camera’s MAC address by choosing MENU (📖30) ▶ [🔍4] tab ▶ [Wireless settings] ▶ [Wi-Fi Settings] ▶ [Check MAC Address].

### Using WPS-Compatible Access Points

WPS makes it easy to complete settings when connecting devices over Wi-Fi. You can use either Push Button Configuration Method or PIN Method for settings on a WPS supported device.

#### 1 Confirm that the computer is connected to an access point.

- For instructions on checking the connection, refer to the device and access point user manuals.

#### 2 Access the Wi-Fi menu.

- Press the [🔍] button.

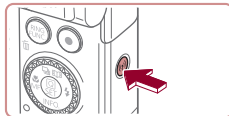

Before Use

Basic Guide

Advanced Guide

Camera Basics

Auto Mode / Hybrid Auto Mode

Other Shooting Modes

P Mode

Tv, Av, M, and C Mode

Playback Mode

Wi-Fi Functions

Setting Menu

Accessories

Appendix

Index



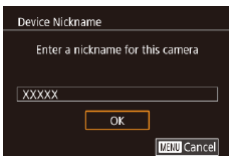

- If the [Device Nickname] screen is displayed, press the [▲][▼] buttons or turn the [●] dial to choose [OK], and then press the [SET] button.

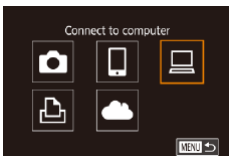

### 3 Choose [Laptop].

- Press the [▲][▼][◀][▶] buttons or turn the [●] dial to choose [Laptop], and then press the [SET] button.

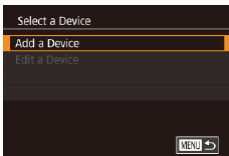

### 4 Choose [Add a Device].

- Press the [▲][▼] buttons or turn the [●] dial to choose [Add a Device], and then press the [SET] button.

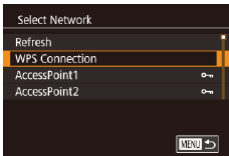

### 5 Choose [WPS Connection].

- Press the [▲][▼] buttons or turn the [●] dial to choose [WPS Connection], and then press the [SET] button.

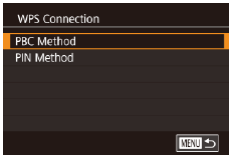

### 6 Choose [PBC Method].

- Press the [▲][▼] buttons or turn the [●] dial to choose [PBC Method], and then press the [SET] button.

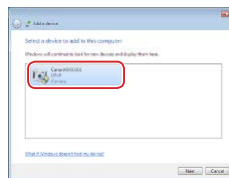
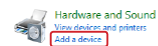
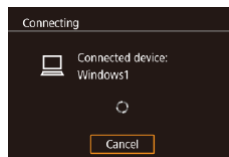
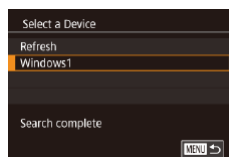
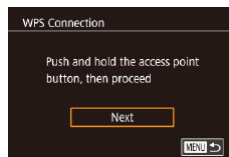

## 7 Establish the connection.

- On the access point, hold down the WPS connection button for a few seconds.
- On the camera, press the [SET] button to go to the next step.
- The camera connects to the access point and lists devices connected to it on the [Select a Device] screen.

## 8 Choose the target device.

- Choose the target device name (either press the [▲][▼] buttons or turn the [●] dial), and then press the [SET] button.

## 9 Install a driver (first Windows connection only).

- When this screen is displayed on the camera, click the Start menu on the computer, click [Control Panel], and then click [Add a device].
- Double-click the connected camera icon.
- Driver installation will begin.
- After driver installation is complete, and the camera and computer connection is enabled, the AutoPlay screen will be displayed. Nothing will be displayed on the camera screen.

Before Use

Basic Guide

Advanced Guide

Camera Basics

Auto Mode / Hybrid Auto Mode

Other Shooting Modes

P Mode

Tv, Av, M, and C Mode

Playback Mode

Wi-Fi Functions

Setting Menu

Accessories

Appendix

Index



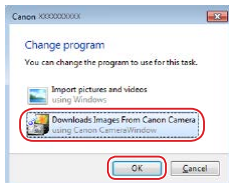

## 10 Display CameraWindow.

- Windows: Access CameraWindow by clicking [Downloads Images From Canon Camera].
- Mac OS: CameraWindow is automatically displayed when a Wi-Fi connection is established between the camera and computer.

## 11 Import images.

- Click [Import Images from Camera], and then click [Import Untransferred Images].
- Images are now saved to the Pictures folder on the computer, in separate folders named by date.
- Click [OK] in the screen that is displayed after image import is complete.
- Use Digital Photo Professional to view images you save to a computer. To view movies, use preinstalled or commonly available software compatible with movies recorded by the camera.



- Once you have connected to devices via the Wi-Fi menu, recent destinations will be listed first when you access the Wi-Fi menu. You can easily connect again by pressing the [▲][▼] buttons to choose the device and then pressing the [Wi-Fi] button. To add a new device, display the device selection screen by pressing the [◀][▶] buttons, and then configure the setting.
- If you prefer not to display recent target devices, choose MENU (130) ▶ [4] ▶ [Wireless settings] ▶ [Wi-Fi Settings] ▶ [Target History] ▶ [Off].
- You can also change the camera nickname on the screen in step 2 (132).
- When the camera is connected to a computer, the camera screen is blank.
- Mac OS: If CameraWindow is not displayed, click the [CameraWindow] icon in the Dock.
- To disconnect from the camera, turn off the camera.
- If you chose [PIN Method] in step 6, a PIN code will be displayed on the screen. Be sure to set this code in the access point. Choose a device in the [Select a Device] screen. For further details, refer to the user manual included with your access point.

## Connecting to Listed Access Points

### 1 View the listed access points.

- View the listed networks (access points) as described in steps 1 – 4 of “Using WPS-Compatible Access Points” (149).

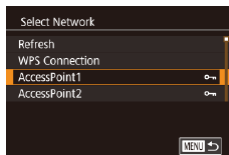

### 2 Choose an access point.

- Press the [▲][▼] buttons or turn the [Wi-Fi] dial to choose a network (access point), and then press the [Wi-Fi] button.

Before Use

Basic Guide

Advanced Guide

Camera Basics

Auto Mode / Hybrid Auto Mode

Other Shooting Modes

P Mode

Tv, Av, M, and C Mode

Playback Mode

Wi-Fi Functions

Setting Menu

Accessories

Appendix

Index



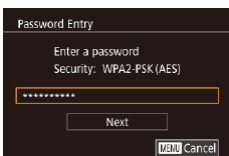

### 3 Enter the access point password.

- Press the button to access the keyboard, and then enter the password ( 32).
- Press the or turn the dial to choose [Next], and then press the button.

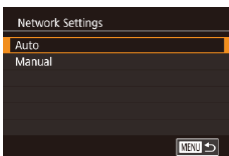

### 4 Choose [Auto].

- Press the or turn the dial to choose [Auto], and then press the button.
- To save images to a connected computer, follow the procedure from step 8 in “Using WPS-Compatible Access Points” ( 149).



- To determine the access point password, check on the access point itself or refer to the user manual.
- If no access points are detected even after you choose [Refresh] in step 2 to update the list, choose [Manual Settings] in step 2 to complete access point settings manually. Follow on-screen instructions and enter an SSID, security settings, and a password.
- When you use an access point that you have already connected to for connecting to another device, [\*] is displayed for the password in step 3. To use the same password, choose [Next] (either press the or turn the dial) and press the button.

## Previous Access Points

You can reconnect to any previous access points automatically by following step 4 in “Using WPS-Compatible Access Points” ( 149).

- To connect to a device via an access point, confirm that the target device is already connected to the access point, and then follow the procedure from step 8 in “Using WPS-Compatible Access Points” ( 149).
- To switch access points, choose [Switch Network] on the screen displayed when you establish a connection, and then either follow the procedure in “Using WPS-Compatible Access Points” ( 149) from step 5 or the procedure in “Connecting to Listed Access Points” ( 151) from step 2.

Before Use

Basic Guide

Advanced Guide

Camera Basics

Auto Mode /  
Hybrid Auto Mode

Other Shooting Modes

P Mode

Tv, Av, M, and C Mode

Playback Mode

Wi-Fi Functions

Setting Menu

Accessories

Appendix

Index



## Sending Images to a Registered Web Service

### Registering Web Services

Use a smartphone or computer to add to the camera Web services that you want to use.

- A smartphone or computer with a browser and Internet connection is required to complete camera settings for CANON iIMAGE GATEWAY and other Web services.
- Check the CANON iIMAGE GATEWAY website for details on browser (Microsoft Internet Explorer, etc.) requirements, including settings and version information.
- For information on countries and regions where CANON iIMAGE GATEWAY is available, visit the Canon website (<http://www.canon.com/cig/>).
- You must have an account with Web services other than CANON iIMAGE GATEWAY if you desire to use them. For further details, check the websites for each Web service you want to register.
- Separate ISP connection and access point fees may be applicable.



- CANON iIMAGE GATEWAY also provides user guides for downloading.

### Registering CANON iIMAGE GATEWAY

Link the camera and CANON iIMAGE GATEWAY by adding CANON iIMAGE GATEWAY as a destination Web service on the camera. Note that you will need to enter an email address used on your computer or smartphone to receive a notification message for completing linkage settings.

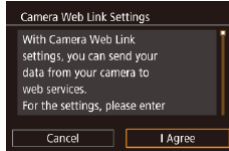
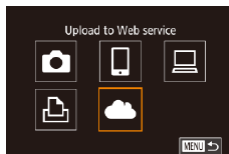
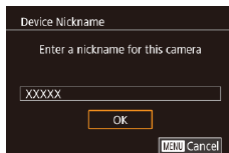
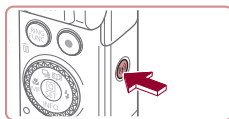

#### 1 Access the Wi-Fi menu.

- Press the  $\left[\left(\right)\right]$  button.

- If the [Device Nickname] screen is displayed, press the  $\left[\blacktriangle\right]\left[\blacktriangledown\right]$  buttons or turn the  $\left[\text{DISP}\right]$  dial to choose [OK], and then press the  $\left[\text{MENU}\right]$  button.

#### 2 Choose $\left[\text{Cloud}\right]$ .

- Press the  $\left[\blacktriangle\right]\left[\blacktriangledown\right]\left[\leftarrow\right]\left[\rightarrow\right]$  buttons or turn the  $\left[\text{DISP}\right]$  dial to choose  $\left[\text{Cloud}\right]$ , and then press the  $\left[\text{MENU}\right]$  button.

#### 3 Accept the agreement to enter an email address.

- Read the displayed content, press the  $\left[\leftarrow\right]\left[\rightarrow\right]$  buttons or turn the  $\left[\text{DISP}\right]$  dial to choose [I Agree], and then press the  $\left[\text{MENU}\right]$  button.

Before Use

Basic Guide

Advanced Guide

Camera Basics

Auto Mode /  
Hybrid Auto Mode

Other Shooting Modes

P Mode

Tv, Av, M, and C Mode

Playback Mode

Wi-Fi Functions

Setting Menu

Accessories

Appendix

Index



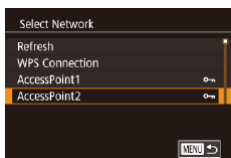

#### 4 Establish a connection with an access point.

- Connect to the access point as described in steps 5 – 7 in “Using WPS-Compatible Access Points” (📖149) or in steps 2 – 4 in “Connecting to Listed Access Points” (📖151).

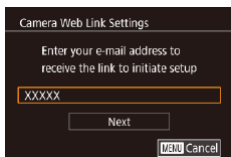

#### 5 Enter your email address.

- Once the camera is connected to CANON iMAGE GATEWAY via the access point, a screen is displayed for entering an email address.
- Enter your e-mail address, press the [◀][▶] buttons or turn the [🌀] dial to choose [Next], and then press the [📧] button.

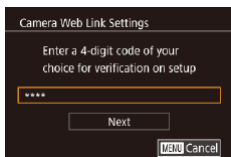

#### 6 Enter a four-digit number.

- Enter any four-digit number, press the [◀][▶] buttons or turn the [🌀] dial to choose [Next], and then press the [🔑] button.
- You will need this four-digit number later when setting up linkage with CANON iMAGE GATEWAY in step 8.

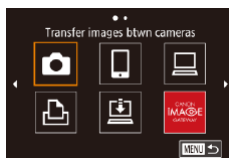
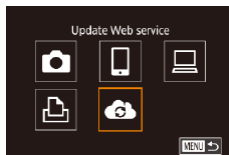
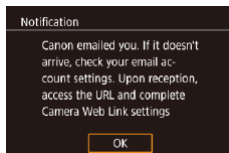

#### 7 Check for the notification message.

- Once information has been sent to CANON iMAGE GATEWAY, you will receive a notification message at the email address entered in step 5.
- The screen is displayed to notify that the e-mail notification was sent. Press the [🔑] button.
- [☁️] now changes to [☁️✓].

#### 8 Access the page in the notification message and complete camera link settings.

- From a computer or smartphone, access the page linked in the notification message.
- Follow the instructions to complete the settings on the camera link settings page.

#### 9 Complete CANON iMAGE GATEWAY settings on the camera.

- Press the [▲][▼][◀][▶] buttons or turn the [🌀] dial to choose [☁️✓], and then press the [🔑] button.
- [📖] (📖162) and CANON iMAGE GATEWAY are now added as destinations.
- You can add other Web services, as needed. In this case, follow the instructions from step 2 in “Registering Other Web Services” (📖155).

Before Use

Basic Guide

Advanced Guide

Camera Basics

Auto Mode /  
Hybrid Auto Mode

Other Shooting Modes

P Mode

Tv, Av, M, and C Mode

Playback Mode

Wi-Fi Functions

Setting Menu

Accessories

Appendix

Index





- Make sure initially that your computer or smartphone mail application is not configured to block email from relevant domains, which may prevent you from receiving the notification message.



- You can also change the camera nickname on the screen in step 1 (📄 166).
- Once you have connected to devices via the Wi-Fi menu, recent destinations will be listed first when you access the menu. Press the [◀][▶] buttons to access the device selection screen and then configure the setting.
- Once a connection destination is assigned in Touch Actions (📄 127), you can automatically reconnect to a previous destination simply by dragging across the screen with the assigned gesture.

## Registering Other Web Services

You can also add Web services besides CANON iMAGE GATEWAY to the camera.



### 1 Log in to CANON iMAGE GATEWAY and access the camera link settings page.

- From a computer or smartphone, access <http://www.canon.com/cig/> to visit CANON iMAGE GATEWAY.



### 2 Configure the Web service you want to use.

- Follow the instructions displayed on the smartphone or computer to set up the Web service.

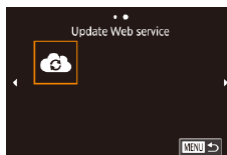

### 3 Choose [⊕].

- Press the [⊕] button.
- Press the [▲][▼][◀][▶] buttons or turn the [🌀] dial to choose [⊕], and then press the [SET] button.
- The Web service settings are now updated.



- If any configured settings change, follow these steps again to update the camera settings.

Before Use

Basic Guide

Advanced Guide

Camera Basics

Auto Mode / Hybrid Auto Mode

Other Shooting Modes

P Mode

Tv, Av, M, and C Mode

Playback Mode

Wi-Fi Functions

Setting Menu

Accessories

Appendix

Index



## Uploading Images to Web Services

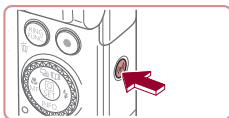

### 1 Access the Wi-Fi menu.

- Press the [Wi-Fi] button.

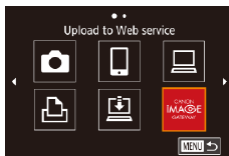

### 2 Choose the destination.

- Choose the Web service icon (either press the [▲][▼][◀][▶] buttons or turn the [DIAL] dial, and then press the [OK] button).
- If multiple recipients or sharing options are used with a Web service, choose the desired item on the [Select Recipient] screen (either press the [▲][▼] buttons or turn the [DIAL] dial, and then press the [OK] button).

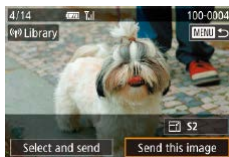

### 3 Send an image.

- Turn the [DIAL] dial to choose an image to send, press the [◀][▶] buttons to choose [Send this image], and then press the [OK] button.
- When uploading to YouTube, read the terms of service, choose [I Agree], and then press the [OK] button.
- After the image is sent, [OK] is displayed on the screen. Press the [OK] button to return to the playback screen.



- Connections require that a memory card with saved images be in the camera.
- You can also send multiple images at once, resize images, and add comments before sending (159).
- To view images uploaded to CANON iMAGE GATEWAY on a smartphone, try the dedicated Canon Online Photo Album app. Download and install the Canon Online Photo Album app for iPhones or iPads from the App Store or for Android devices from Google Play.

Before Use

Basic Guide

Advanced Guide

Camera Basics

Auto Mode /  
Hybrid Auto Mode

Other Shooting Modes

P Mode

Tv, Av, M, and C Mode

Playback Mode

Wi-Fi Functions

Setting Menu

Accessories

Appendix

Index





# Printing Images Wirelessly from a Connected Printer

Connect the camera to a printer via Wi-Fi to print as follows. These steps show how to use the camera as an access point, but you can also use an existing access point (146).

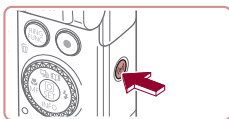

## 1 Access the Wi-Fi menu.

- Press the [Wi-Fi] button.



## 2 Choose [Printer].

- Press the [Up][Down][Left][Right] buttons or turn the [Dial] dial to choose [Printer], and then press the [OK] button.

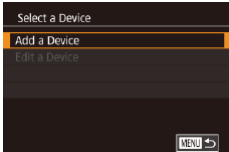

## 3 Choose [Add a Device].

- Press the [Up][Down] buttons or turn the [Dial] dial to choose [Add a Device], and then press the [OK] button.

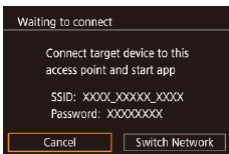

- The camera SSID and password are displayed.

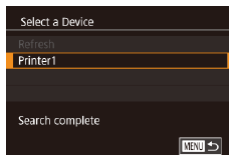

## 4 Connect the printer to the network.

- In the printer's Wi-Fi setting menu, choose the SSID (network name) displayed on the camera to establish a connection.
- In the password field, enter the password displayed on the camera.

## 5 Choose the printer.

- Choose the printer name (either press the [Up][Down] buttons or turn the [Dial] dial), and then press the [OK] button.

## 6 Choose an image to print.

- Press the [Left][Right] buttons or turn the [Dial] dial to choose an image.

## 7 Access the printing screen.

- Press the [OK] button, choose [Print] in the menu (either press the [Up][Down][Left][Right] buttons or turn the [Dial] dial), and then press the [OK] button again.

## 8 Print the image.

- For detailed printing instructions, see "Printing Images" (184).
- To end the connection, press the [Up] button at step 6, choose [OK] on the confirmation screen (either press the [Left][Right] buttons or turn the [Dial] dial), and then press the [OK] button.

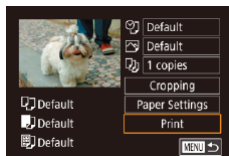

Before Use

Basic Guide

Advanced Guide

Camera Basics

Auto Mode / Hybrid Auto Mode

Other Shooting Modes

P Mode

Tv, Av, M, and C Mode

Playback Mode

Wi-Fi Functions

Setting Menu

Accessories

Appendix

Index





- Connections require that a memory card with saved images be in the camera.
- Once you have connected to devices via the Wi-Fi menu, recent destinations will be listed first when you access the Wi-Fi menu. You can easily connect again by pressing the [▲][▼] buttons to choose the device and then pressing the [☑] button. To add a new device, display the device selection screen by pressing the [◀][▶] buttons, and then configure the setting.
- If you prefer not to display recent target devices, choose MENU (30) ▶ [4] tab ▶ [Wireless settings] ▶ [Wi-Fi Settings] ▶ [Target History] ▶ [Off].
- To connect without entering a password in step 4, choose MENU (30) ▶ [4] tab ▶ [Wireless settings] ▶ [Wi-Fi Settings] ▶ [Password] ▶ [Off]. [Password] will no longer be displayed on the SSID screen (in step 3).
- To use another access point, follow steps 3 – 4 in "Using Another Access Point" (146).

## Sending Images to Another Camera

Connect two cameras via Wi-Fi and send images between them as follows.

- Only Canon-brand cameras equipped with a Wi-Fi function can be connected to wirelessly. You cannot connect to a Canon-brand camera that does not have a Wi-Fi function, even if it supports FlashAir/Eye-Fi cards.

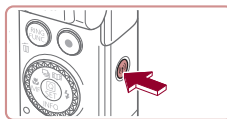

### 1 Access the Wi-Fi menu.

- Press the [Wi-Fi] button.

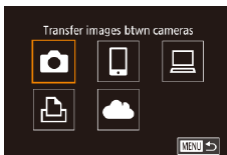

### 2 Choose [Camera].

- Press the [▲][▼][◀][▶] buttons or turn the [Dial] dial to choose [Camera], and then press the [☑] button.

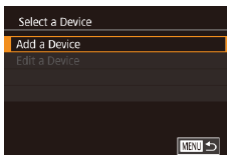

### 3 Choose [Add a Device].

- Press the [▲][▼] buttons or turn the [Dial] dial to choose [Add a Device], and then press the [☑] button.
- Follow steps 1 – 3 on the target camera too.
- Camera connection information will be added when [Start connection on target camera] is displayed on both camera screens.

Before Use

Basic Guide

Advanced Guide

Camera Basics

Auto Mode / Hybrid Auto Mode

Other Shooting Modes

P Mode

Tv, Av, M, and C Mode

Playback Mode

Wi-Fi Functions

Setting Menu

Accessories

Appendix

Index



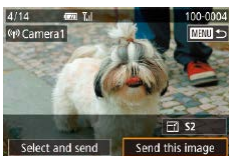

#### 4 Send an image.

- Turn the [DISP] dial to choose an image to send, press the [L] [R] buttons to choose [Send this image], and then press the [DISP] button.
- [Transfer completed] is displayed after the image is sent, and the image transfer screen is displayed again.
- To end the connection, press the [MENU] button, choose [OK] on the confirmation screen (either press the [L] [R] buttons or turn the [DISP] dial), and then press the [DISP] button.



- Connections require that a memory card be in the camera.
- Once you have connected to devices via the Wi-Fi menu, recent destinations will be listed first when you access the Wi-Fi menu. You can easily connect again by pressing the [▲] [▼] buttons to choose the device and then pressing the [DISP] button. To add a new device, display the device selection screen by pressing the [L] [R] buttons, and then configure the setting.
- If you prefer not to display recent target devices, choose MENU (F30) ► [4] tab ► [Wireless settings] ► [Wi-Fi Settings] ► [Target History] ► [Off].
- You can also send multiple images at once and change the image size before sending (159, 161).
- Once a connection destination is assigned in Touch Actions (127), you can automatically reconnect to a previous destination simply by dragging across the screen with the assigned gesture.

## Image Sending Options

You can choose multiple images to send at once and change the image recording pixel setting (size) before sending. Some Web services also enable you to annotate the images you send.

### Sending Multiple Images

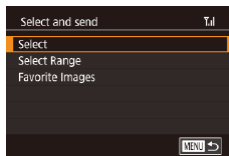
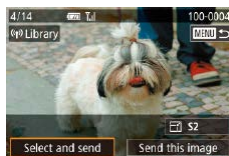

#### 1 Choose [Select and send].

- On the image transfer screen, press the [L] [R] buttons to choose [Select and send], and then press the [DISP] button.

#### 2 Choose a selection method.

- Press the [▲] [▼] buttons or turn the [DISP] dial to choose a selection method.

### Choosing Images Individually

#### 1 Choose [Select].

- Following step 2 in “Sending Multiple Images” (159), choose [Select] and press the [DISP] button.

Before Use

Basic Guide

Advanced Guide

Camera Basics

Auto Mode /  
Hybrid Auto Mode

Other Shooting Modes

P Mode

Tv, Av, M, and C Mode

Playback Mode

Wi-Fi Functions

Setting Menu

Accessories

Appendix

Index



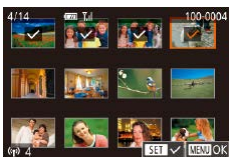

## 2 Choose an image.

- Press the [▲][▼][◀][▶] buttons to choose an image to send, and then press the [✓] button. [✓] is displayed.
- To cancel selection, press the [⊗] button again. [✓] is no longer displayed.
- Repeat this process to choose additional images.
- After you finish choosing images, press the [MENU] button.
- Press the [◀][▶] buttons or turn the [⊗] dial to choose [OK], and then press the [⊗] button.

## 3 Send the images.

- Press the [◀][▶] buttons or turn the [⊗] dial to choose [Send], and then press the [⊗] button.



- You can also choose images in step 2 by moving the zoom lever twice toward [Q] to access single-image display and then pressing the [◀][▶] buttons or turning the [⊗] dial.

## Selecting a Range

### 1 Choose [Select Range].

- Following step 2 in “Sending Multiple Images” (159), choose [Select Range] and press the [⊗] button.

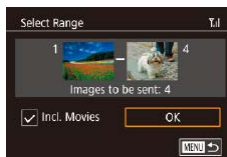

## 2 Choose images.

- Follow steps 2 – 3 in “Selecting a Range” (122) to specify images.
- To include movies, press the [▲][▼][◀][▶] buttons to choose [Incl. Movies], and then press the [⊗] button to mark the option as selected (✓).
- Press the [▲][▼][◀][▶] buttons to choose [OK], and then press the [⊗] button.

## 3 Send the images.

- Press the [◀][▶] buttons or turn the [⊗] dial to choose [Send], and then press the [⊗] button.

## Sending Favorite Images

Send only images tagged as favorites (126).

### 1 Choose [Favorite Images].

- Following step 2 in “Sending Multiple Images” (159), choose [Favorite Images] and press the [⊗] button.
- An image selection screen for favorites is displayed. If you prefer not to include an image, choose the image and press the [⊗] button to remove [✓].
- After you finish choosing images, press the [MENU] button, choose [OK], and then press the [⊗] button.

### 2 Send the images.

- Press the [◀][▶] buttons or turn the [⊗] dial to choose [Send], and then press the [⊗] button.

Before Use

Basic Guide

Advanced Guide

Camera Basics

Auto Mode / Hybrid Auto Mode

Other Shooting Modes

P Mode

Tv, Av, M, and C Mode

Playback Mode

Wi-Fi Functions

Setting Menu

Accessories

Appendix

Index





- In step 1, [Favorite Images] is not available unless you have tagged images as favorites.

## Notes on Sending Images

- Depending on the condition of the network you are using, it may take a long time to send movies. Be sure to keep an eye on the camera battery level.
- Web services may limit the number of images or length of movies you can send.
- For movies that you do not compress (135), a separate, compressed file is sent instead of the original file. Note that this may delay transmission, and the file cannot be sent unless there is enough space for it on the memory card.
- When sending movies to smartphones, note that the supported image quality varies depending on the smartphone. For details, refer to the smartphone user manual.
- On the screen, wireless signal strength is indicated by the following icons:  
[Signal strength icons] high, [Signal strength icons] medium, [Signal strength icons] low, [Signal strength icons] weak
- Sending images to Web services will take less time when resending images you have already sent that are still on the CANON iIMAGE GATEWAY server.

## Choosing the Number of Recording Pixels (Image Size)

On the image transfer screen, choose [F] by pressing the [▲][▼] buttons, and then press the [📷] button. On the screen displayed, choose the recording pixel setting (image size) by pressing the [▲][▼] buttons, and then press the [📷] button.

- To send images at original size, select [No] as the resizing option.
- Choosing [S2] will resize images that are larger than the selected size before sending.
- Movies cannot be resized.



- Image size can also be configured in MENU (30) ▶ [4] tab ▶ [Wireless settings] ▶ [Wi-Fi Settings] ▶ [Resize for Sending].

## Adding Comments

Using the camera, you can add comments to images that you send to e-mail addresses, social networking services, etc. The number of characters and symbols that can be entered may differ depending on the Web service.

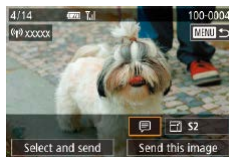

### 1 Access the screen for adding comments.

- On the image transfer screen, choose [F] by pressing the [▲][▼][◀][▶] buttons, and then press the [📷] button.

### 2 Add a comment (32).

### 3 Send the image.



- When a comment is not entered, the comment set in CANON iIMAGE GATEWAY is automatically sent.
- You can also annotate multiple images before sending them. The same comment is added to all images sent together.

Before Use

Basic Guide

Advanced Guide

Camera Basics

Auto Mode / Hybrid Auto Mode

Other Shooting Modes

P Mode

Tv, Av, M, and C Mode

Playback Mode

Wi-Fi Functions

Setting Menu

Accessories

Appendix

Index



## Sending Images Automatically (Image Sync)

Images on the memory card that have not been transferred already can be sent to a computer or Web services via CANON iMAGE GATEWAY. Note that images cannot be sent only to Web services.

### Initial Preparations

#### Preparing the Camera

Register [☰] as the destination. On the destination computer, you will install and configure Image Transfer Utility, a free software compatible with Image Sync.



#### 1 Add [☰] as a destination.

- Add [☰] as a destination, as described in “Registering CANON iMAGE GATEWAY” (📖153).
- To include a Web service as the destination, log in to CANON iMAGE GATEWAY (📖153), select your camera model, access the Web service settings screen, and choose the destination Web service in Image Sync settings. For details, refer to CANON iMAGE GATEWAY Help.

#### 2 Choose the type of images to send (only when sending movies with images).

- Press the [MENU] button, choose [Wireless settings] on the [4] tab, and then choose [Wi-Fi Settings] (📖30).
- Press the [▲][▼] buttons to choose [Image Sync], and then press the [▲][▼] buttons to choose [Stills/Movies].

#### Preparing the Computer

Install and configure the software on the destination computer.



#### 1 Install Image Transfer Utility.

- Install Image Transfer Utility on a computer connected to the Internet (📖147).
- Image Transfer Utility can also be downloaded from the Image Sync settings page of CANON iMAGE GATEWAY (📖153).

#### 2 Register the camera.

- Windows: In the taskbar, right-click [🖥️], and then click [Add new camera].
- Mac OS: In the menu bar, click [🖥️], and then click [Add new camera].
- A list of cameras linked to CANON iMAGE GATEWAY is displayed. Choose the camera from which images are to be sent.
- Once the camera is registered and the computer is ready to receive images, the icon changes to [📷].

Before Use

Basic Guide

Advanced Guide

Camera Basics

Auto Mode /  
Hybrid Auto Mode

Other Shooting Modes

P Mode

Tv, Av, M, and C Mode

Playback Mode

Wi-Fi Functions

Setting Menu

Accessories

Appendix



Index



## Sending Images

Images sent from the camera are automatically saved to the computer. If the computer that you intend to send images to is turned off, the images will be stored temporarily on the CANON iIMAGE GATEWAY server. Stored images are regularly erased, so make sure to turn on the computer and save the images.

### 1 Send images.

- Follow steps 1 – 2 in “Uploading Images to Web Services” (📖156) and choose .
- Sent images are labeled with a  icon.

### 2 Save the images to the computer.

- Images are automatically saved to the computer when you turn it on.
- Images are automatically sent to Web services from the CANON iIMAGE GATEWAY server, even if the computer is off.



- Using a fully charged battery pack is recommended when sending images.



- Even if images were imported to the computer through a different method, any images not sent to the computer via CANON iIMAGE GATEWAY will be sent to the computer.
- Sending is faster when the destination is a computer on the same network as the camera, because images are sent via the access point instead of CANON iIMAGE GATEWAY. Note that images stored on the computer are sent to CANON iIMAGE GATEWAY, so the computer must be connected to the Internet.

## Viewing Images Sent via Image Sync on a Smartphone

By installing the Canon Online Photo Album (Canon OPA) app, you can use your smartphone to view and download images sent via Image Sync while they are stored temporarily on the CANON iIMAGE GATEWAY server.

In preparation, enable smartphone access as follows.

- Make sure you have completed the settings described in “Preparing the Computer” (📖162).
- Download and install the Canon Online Photo Album app for iPhones or iPads from the App Store or for Android devices from Google Play.
- Log in to CANON iIMAGE GATEWAY (📖153), select your camera model, access the Web service settings screen, and enable viewing and downloading from a smartphone in the Image Sync settings. For details, refer to CANON iIMAGE GATEWAY Help.



- Once images stored temporarily on the CANON iIMAGE GATEWAY server have been deleted, they can no longer be viewed.
- Images you sent before enabling smartphone viewing and downloading in Image Sync settings cannot be accessed this way.



- For Canon Online Photo Album instructions, refer to Canon Online Photo Album Help.

Before Use

Basic Guide

Advanced Guide

Camera Basics

Auto Mode /  
Hybrid Auto Mode

Other Shooting Modes

P Mode

Tv, Av, M, and C Mode

Playback Mode

Wi-Fi Functions

Setting Menu

Accessories

Appendix

Index



## Using a Smartphone to View Camera Images and Control the Camera

You can do the following with the dedicated smartphone app Camera Connect.

- Browse images on the camera and save them to the smartphone
- Geotag images on the camera (📖164)
- Shoot remotely (📖164)



- Privacy settings must be configured in advance to allow image viewing on the smartphone (📖144, 📖165).

## Geotagging Images on the Camera

GPS data recorded on a smartphone using the dedicated Camera Connect application can be added to images on the camera. Images are tagged with information including the latitude, longitude, and elevation.



- Before shooting, make sure the date and time and your home time zone are set correctly, as described in “Setting the Date and Time” (📖20). Also follow the steps in “World Clock” (📖172) to specify any shooting destinations in other time zones.
- Others may be able to locate or identify you by using location data in your geotagged still images or movies. Be careful when sharing these images with others, as when posting images online where many others can view them.

## Shooting Remotely

As you check a shooting screen on your smartphone, you can use it to shoot remotely.

### 1 Choose a shooting mode.

- Turn the mode dial to choose **[P]**, **[Tv]**, **[Av]**, **[M]**, or **[C]** as the mode.

### 2 Secure the camera.

- Once remote shooting begins, the camera lens will come out. Lens motion from zooming may also move the camera out of position. Keep the camera still by mounting it on a tripod or taking other measures.

### 3 Connect the camera and smartphone (📖144).

- In the privacy settings, choose [Yes].

### 4 Choose remote shooting.

- In Camera Connect on the smartphone, choose remote shooting.
- The camera lens will come out. Keep your fingers away from the lens, and make sure no objects will obstruct it.
- Once the camera is ready for remote shooting, a live image from the camera will be displayed on the smartphone.
- At this time, a message is displayed on the camera, and all operations except pressing the power button are disabled.

### 5 Shoot.

- Use the smartphone to shoot.

Before Use

Basic Guide

Advanced Guide

Camera Basics

Auto Mode /  
Hybrid Auto Mode

Other Shooting Modes

P Mode

Tv, Av, M, and C Mode

Playback Mode

Wi-Fi Functions

Setting Menu

Accessories

Appendix

Index







- [P] mode is used for shooting in modes other than [P], [Tv], [Av], [M], and [C]. However, some Quick Set and MENU settings you have configured in advance may be changed automatically.
- Movie shooting is not available.



- Any jerky subject motion shown on the smartphone due to the connection environment will not affect recorded images.
- Captured images are not transferred to the smartphone. Use the smartphone to browse and import images from the camera.

## Editing or Erasing Wi-Fi Settings

Edit or erase Wi-Fi settings as follows.

### Editing Connection Information

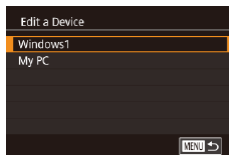
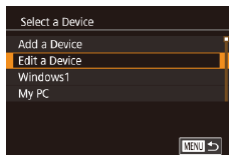
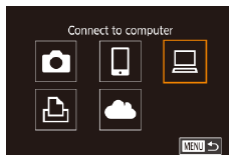

#### 1 Access the Wi-Fi menu and choose a device to edit.

- Press the [(w)] button.
- Press the [▲][▼][◀][▶] buttons or turn the [●] dial to choose the icon of a device to edit, and then press the [(w)] button.

#### 2 Choose [Edit a Device].

- Press the [▲][▼] buttons or turn the [●] dial to choose [Edit a Device], and then press the [(w)] button.

#### 3 Choose the device to edit.

- Press the [▲][▼] buttons or turn the [●] dial to choose the device to edit, and then press the [(w)] button.

#### 4 Choose the item to edit.

- Press the [▲][▼] buttons or turn the [●] dial to choose the item to edit, and then press the [(w)] button.
- The items you can change depend on the device or service.

Before Use

Basic Guide

Advanced Guide

Camera Basics

Auto Mode /  
Hybrid Auto Mode

Other Shooting Modes

P Mode

Tv, Av, M, and C Mode

Playback Mode

Wi-Fi Functions

Setting Menu

Accessories

Appendix

Index



Configurable Items	Connection				
					Web Services
[Change Device Nickname] (166)	<input type="radio"/>	<input type="radio"/>	<input type="radio"/>	<input type="radio"/>	–
[View Settings] (144)	–	<input type="radio"/>	–	–	–
[Erase Connection Info] (166)	<input type="radio"/>	<input type="radio"/>	<input type="radio"/>	<input type="radio"/>	–

O : Configurable – : Not configurable

## Changing a Device Nickname

You can change the device nickname (display name) that is displayed on the camera.

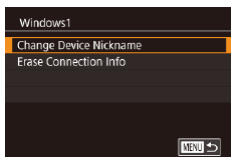

- Following step 4 in “Editing Connection Information” (165), choose [Change Device Nickname] and press the button.
- Select the input field and press the button. Use the keyboard displayed to enter a new nickname (32).

## Erasing Connection Information

Erase connection information (information about devices that you have connected to) as follows.

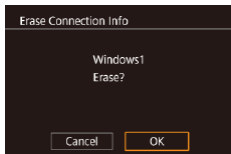

- Following step 4 in “Editing Connection Information” (165), choose [Erase Connection Info] and press the button.
- After [Erase?] is displayed, press the buttons or turn the dial to choose [OK], and then press the button.
- The connection information will be erased.

## Changing the Camera Nickname

Change the camera nickname (displayed on connected devices) as desired.

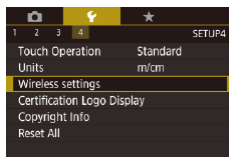

### 1 Choose [Wireless settings].

- Press the button and choose [Wireless settings] on the (30).

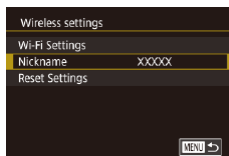

### 2 Choose [Nickname].

- Press the buttons or turn the dial to choose [Nickname], and then press the button.

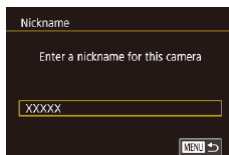

### 3 Change the nickname.

- Press the button to access the keyboard (32), and then enter a nickname.



- A message is displayed if the nickname you enter begins with a symbol or space. Press the button and enter a different nickname.
- You can also change the nickname from the [Device Nickname] screen displayed when you first use Wi-Fi. In this case, select the text box, press the button to access the keyboard, and then enter a new nickname.

Before Use

Basic Guide

Advanced Guide

Camera Basics

Auto Mode / Hybrid Auto Mode

Other Shooting Modes

P Mode

Tv, Av, M, and C Mode

Playback Mode

Wi-Fi Functions

Setting Menu

Accessories

Appendix

Index



## Returning the Wi-Fi Settings to Default

Return the Wi-Fi settings to default if you transfer ownership of the camera to another person, or dispose of it.

Resetting the Wi-Fi settings will also clear all Web service settings. Be sure that you want to reset all Wi-Fi settings before using this option.

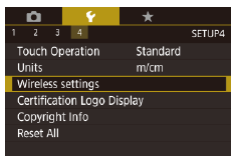

### 1 Choose [Wireless settings].

- Press the [MENU] button and choose [Wireless settings] on the [4] tab (130).

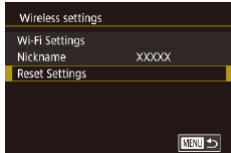

### 2 Choose [Reset Settings].

- Press the [▲][▼] buttons or turn the [DISP.] dial to choose [Reset Settings], and then press the [DISP.] button.

### 3 Restore the default settings.

- Press the [◀][▶] buttons or turn the [DISP.] dial to choose [OK], and then press the [DISP.] button.
- The Wi-Fi settings are now reset.



- To reset other settings (aside from Wi-Fi) to defaults, choose [Reset All] on the [4] tab (176).

Before Use

Basic Guide

Advanced Guide

Camera Basics

Auto Mode /  
Hybrid Auto Mode

Other Shooting Modes

P Mode

Tv, Av, M, and C Mode

Playback Mode

Wi-Fi Functions

Setting Menu

Accessories

Appendix

Index



# Setting Menu

Customize or adjust basic camera functions for greater convenience

## Adjusting Basic Camera Functions

MENU (📖30) settings on the [👉1], [👉2], [👉3], and [👉4] tabs can be configured. Customize commonly used functions as desired, for greater convenience.

### Date-Based Image Storage

Instead of saving images in folders created each month, you can have the camera create folders each day you shoot to store shots taken that day.

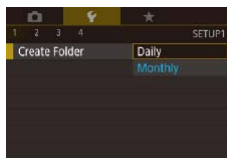

- Choose [Create Folder] on the [👉1] tab, and then choose [Daily].
- Images will now be saved in folders created on the shooting date.

### File Numbering

Your shots are automatically numbered in sequential order (0001 – 9999) and saved in folders that store up to 2,000 images each. You can change how the camera assigns file numbers.

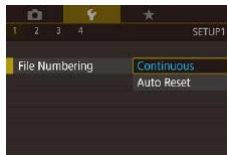

- Choose [File Numbering] on the [👉1] tab, and then choose an option.

Continuous	Images are numbered consecutively (until the 9999th shot is taken/saved) even if you switch memory cards.
Auto Reset	Image numbering is reset to 0001 if you switch memory cards, or when a new folder is created.

Before Use

Basic Guide

Advanced Guide

Camera Basics

Auto Mode / Hybrid Auto Mode

Other Shooting Modes

P Mode

Tv, Av, M, and C Mode

Playback Mode

Wi-Fi Functions

Setting Menu

Accessories

Appendix

Index





- Regardless of the option selected in this setting, shots may be numbered consecutively after the last number of existing images on newly inserted memory cards. To start saving shots from 0001, use an empty (or formatted, 169) memory card.

## Formatting Memory Cards

Before using a new memory card or a card formatted in another device, you should format the card with this camera.

Formatting erases all data on a memory card. Before formatting, copy images on the memory card to a computer, or take other steps to back them up.

### 1 Access the [Format] screen.

- Choose [Format] on the [1] tab, and then press the [OK] button.

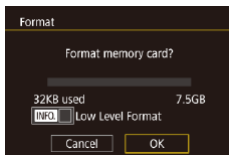

### 2 Choose [OK].

- Press the [Left][Right] buttons or turn the [Dial] dial to choose [OK], and then press the [OK] button.

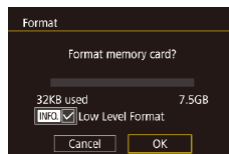

### 3 Restore the default settings.

- To begin the formatting process, press the [Up][Down] buttons or turn the [Dial] dial to choose [OK], and then press the [OK] button.
- When formatting is finished, [Memory card formatting complete] is displayed. Press the [OK] button.

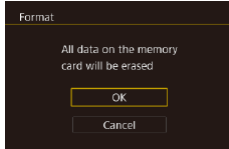

- Formatting or erasing data on a memory card only changes file management information on the card and does not erase the data completely. When transferring or disposing of memory cards, take steps to protect personal information if necessary, such as physically destroying the cards.



- The total card capacity indicated on the formatting screen may be less than the advertised capacity.

## Low-Level Formatting

Perform low-level formatting in the following cases: [Memory card error] is displayed, the camera is not working correctly, card image reading/writing is slower, continuous shooting is slower, or movie recording suddenly stops. Low-level formatting erases all data on a memory card. Before low-level formatting, copy images on the memory card to a computer, or take other steps to back them up.

- On the screen in step 2 of “Formatting Memory Cards” (169), press the [Down] button to choose [Low Level Format]. A [Checkmark] icon is displayed.
- Follow step 2 in “Formatting Memory Cards” (169) to continue with the formatting process.



- Low-level formatting takes longer than “Formatting Memory Cards” (169), because data is erased from all storage regions of the memory card.
- You can cancel low-level formatting in progress by choosing [Stop]. In this case, all data will be erased, but the memory card can be used normally.

Before Use

Basic Guide

Advanced Guide

Camera Basics

Auto Mode / Hybrid Auto Mode

Other Shooting Modes

P Mode

Tv, Av, M, and C Mode

Playback Mode

Wi-Fi Functions

Setting Menu

Accessories

Appendix

Index



## Changing the Video System

Set the video system of any television used for display. This setting determines the image quality (frame rate) available for movies.

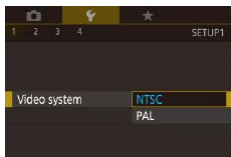

- Choose [Video system] on the [1] tab, and then choose an option.

## Electronic Level Calibration

Calibrate the electronic level if it seems ineffective in helping you level the camera.

For greater calibration accuracy, display grid lines (106) to help you level the camera in advance.

### 1 Make sure the camera is level.

- Place the camera on a flat surface, such as a table.

### 2 Calibrate the electronic level.

- Choose [Electronic Level] on the [1] tab, and then press the [OK] button.
- To adjust left/right tilt, choose [Horizontal Roll Calibration], and to adjust forward/backward tilt, choose [Vertical Pitch Calibration], followed by the [OK] button. A confirmation message is displayed.
- Choose [OK], and then press the [OK] button.

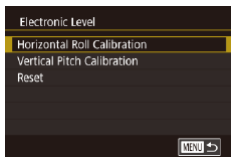

## Resetting the Electronic Level

Restore the electronic level to its original state as follows. Note that this is not possible unless you have calibrated the electronic level.

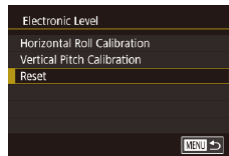

- Choose [Electronic Level] on the [1] tab, and then press the [OK] button.
- Choose [Reset], and then press the [OK] button.
- Choose [OK], and then press the [OK] button.

## Start-Up Screen

Customize the start-up screen shown after you turn the camera on as follows.

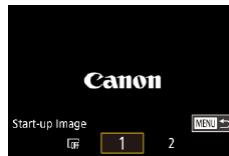

- Choose [Start-up Image] on the [1] tab, and then press the [OK] button.
- Press the [Left] [Right] buttons or turn the [Dial] dial to choose an option.

Before Use

Basic Guide

Advanced Guide

Camera Basics

Auto Mode /  
Hybrid Auto Mode

Other Shooting Modes

P Mode

Tv, Av, M, and C Mode

Playback Mode

Wi-Fi Functions

Setting Menu

Accessories

Appendix

Index



## Using Eco Mode

This function allows you to conserve battery power in Shooting mode. When the camera is not in use, the screen quickly darkens to reduce battery consumption.

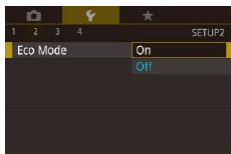

### 1 Configure the setting.

- Choose [Eco Mode] on the [F2] tab, and then choose [On].
- [ECO] is now shown on the shooting screen (197).
- The screen darkens when the camera is not used for approximately two seconds; approximately ten seconds after darkening, the screen turns off. The camera turns off after approximately three minutes of inactivity.

### 2 Shoot.

- To activate the screen and prepare for shooting when the screen is off but the lens is still out, press the shutter button halfway.

## Power-Saving Adjustment

Adjust the timing of automatic camera and screen deactivation (Auto Power Down and Display Off, respectively) as needed (27).

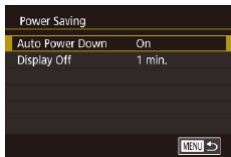

- Choose [Power Saving] on the [F2] tab, and then press the [SET] button.
- Choose an item, press the [SET] button, and then press the [▲][▼] buttons or turn the [DIAL] dial to configure the setting.



- To conserve battery power, you should normally choose [On] for [Auto Power Down] and [1 min.] or less for [Display Off].



- The [Display Off] setting is applied even if you set [Auto Power Down] to [Off].
- These power-saving functions are not available when you have set Eco mode (171) to [On].

## Screen Brightness

Adjust screen brightness as follows.



- Choose [Disp. Brightness] on the [F2] tab, press the [SET] button, and then press the [◀][▶] buttons or turn the [DIAL] dial to adjust the brightness.



- For maximum brightness, press and hold [▼] for at least one second when the shooting screen is displayed or when in single-image display. (This will override the [Disp. Brightness] setting on the [F2] tab.) To restore the original brightness, press and hold the [▼] button again for at least one second or restart the camera.

Before Use

Basic Guide

Advanced Guide

Camera Basics

Auto Mode /  
Hybrid Auto Mode

Other Shooting Modes

P Mode

Tv, Av, M, and C Mode

Playback Mode

Wi-Fi Functions

Setting Menu

Accessories

Appendix

Index



## Switching the Color of Screen Information

▶ Still Images ▶ Movies

Information displayed on the screen and menus can be changed to a color suitable for shooting under low-light conditions. Enabling this setting is useful in modes such as  (165).

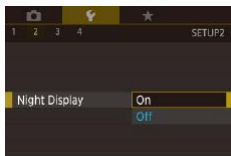

- Choose [Night Display] on the  tab, and then choose [On] (130).
- To restore the original display, choose [Off].



- You can also return the setting to [Off] by holding down the  button for at least one second on the shooting screen or in Playback mode during single-image display.







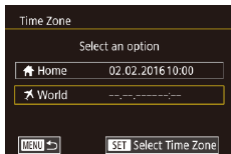

## World Clock

To ensure that your shots will have the correct local date and time when you travel abroad, simply register the destination in advance and switch to that time zone. This convenient feature eliminates the need to change the Date/Time setting manually.



Before using the world clock, be sure to set the date and time and your home time zone, as described in “Setting the Date and Time” (20).





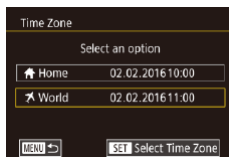





### 1 Specify your destination.







- Choose [Time Zone] on the  tab, and then press the  button.
- Press the / buttons or turn the  dial to choose , and then press the  button.
- Press the / buttons to choose the destination.



- Adjusting the date or time while in  mode (21) will automatically update your  time and date.

- To set daylight saving time (1 hour ahead), choose  by pressing the / buttons or turning the  dial, and then choose  by pressing the / buttons.
- Press the  button.





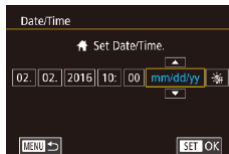

### 2 Switch to the destination time zone.

- Press the / buttons or turn the  dial to choose , and then press the  button.
-  is now shown on the shooting screen (197).

## Date and Time

Adjust the date and time as follows.



- Choose [Date/Time] on the  tab, and then press the  button.
- Press the / buttons to choose an option, and then adjust the setting, either by pressing the / buttons or turning the  dial.

Before Use

Basic Guide

Advanced Guide

Camera Basics

Auto Mode /  
Hybrid Auto Mode

Other Shooting Modes

P Mode

Tv, Av, M, and C Mode

Playback Mode

Wi-Fi Functions

Setting Menu

Accessories

Appendix

Index





## Lens Retraction Timing

The lens is normally retracted for safety about one minute after you press the [▶] button in Shooting mode (126). To have the lens retracted immediately after you press the [▶] button, set the retraction timing to [0 sec.].

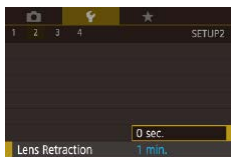

- Choose [Lens Retraction] on the [F2] tab, and then choose [0 sec.].

## Display Language

Change the display language as needed.



- Choose [Language] on the [F3] tab, and then press the [OK] button.
- Press the [▲][▼][◀][▶] buttons or turn the [DIAL] dial to choose a language, and then press the [OK] button.



- You can also access the [Language] screen in Playback mode by pressing and holding the [OK] button and immediately pressing the [MENU] button.

## Silencing Camera Operations

Silence camera sounds and movies as follows.

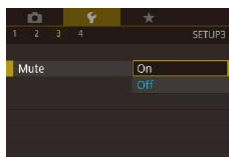

- Choose [Mute] on the [F3] tab, and then choose [On].



- Operation can also be silenced by holding down the [▼] button as you turn the camera on.
- Sound is not played during movies (110) if you mute camera sounds. To restore sound during movies, press the [▲] button or drag up across the screen. Adjust volume as needed by pressing the [▲][▼] buttons or by dragging up or down quickly.

## Adjusting the Volume

Adjust the volume of individual camera sounds as follows.

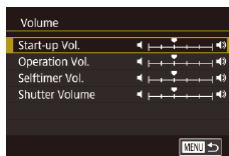

- Choose [Volume] on the [F3] tab, and then press the [OK] button.
- Choose an item, and then press the [◀][▶] buttons to adjust the volume.

Before Use

Basic Guide

Advanced Guide

Camera Basics

Auto Mode /  
Hybrid Auto Mode

Other Shooting Modes

P Mode

Tv, Av, M, and C Mode

Playback Mode

Wi-Fi Functions

Setting Menu

Accessories

Appendix

Index



## Customizing Sounds

Customize camera operating sounds as follows.

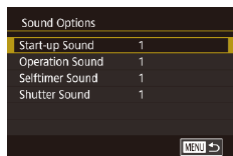

- Choose [Sound Options] on the [F3] tab, and then press the [OK] button.
- Choose an item, and then press the [▲][▼] buttons to change the sound.



- The shutter sound in digest movies recorded in [A] mode (36) cannot be changed.

## Hiding Hints and Tips

Hints and tips are normally shown when you choose Quick Set menu (29) items. If you prefer, you can deactivate this information.

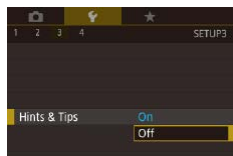

- Choose [Hints & Tips] on the [F3] tab, and then choose [Off].

## Listing Shooting Modes by Icon

List shooting modes on the selection screen by icon only, without mode names, for faster selection.

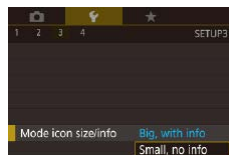

- Choose [Mode icon size/info] on the [F3] tab, and then choose [Small, no info].

## Adjusting the Touch-Screen Panel

Sensitivity of the touch-screen panel can be increased to respond to a lighter touch, or you can disable touch control.

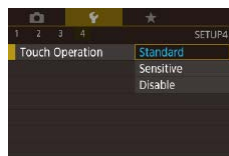

- Choose [F4] tab ► [Touch Operation], and then choose the desired option.
- To increase touch-screen panel sensitivity, choose [Sensitive], and to disable touch control, choose [Disable].

Before Use

Basic Guide

Advanced Guide

Camera Basics

Auto Mode /  
Hybrid Auto Mode

Other Shooting Modes

P Mode

Tv, Av, M, and C Mode

Playback Mode

Wi-Fi Functions

Setting Menu

Accessories

Appendix

Index



## Metric / Non-Metric Display

Change the unit of measurement shown in the zoom bar (📖34), the MF indicator (📖87), and elsewhere from m/cm to ft/in as needed.

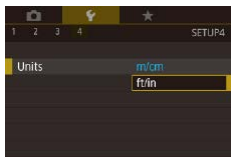

- Choose [Units] on the [F4] tab, and then choose [ft/in].

## Checking Certification Logos

Some logos for certification requirements met by the camera can be viewed on the screen. Other certification logos are printed in this guide, on the camera packaging, or on the camera body.

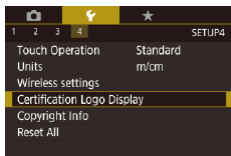

- Choose [Certification Logo Display] on the [F4] tab, and then press the [SET] button.

## Setting Copyright Information to Record in Images

To record the author's name and copyright details in images, set this information beforehand as follows.

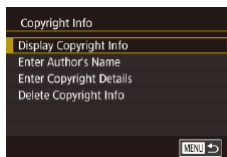

- Choose [Copyright Info] on the [F4] tab, and then press the [SET] button.
- Press the [▲][▼] buttons or turn the [DISP] dial to choose [Enter Author's Name] or [Enter Copyright Details]. Press the [SET] button to access the keyboard, and enter the name (📖32).
- Press the [MENU] button. When [Accept changes?] is displayed, press the [◀][▶] buttons or turn the [DISP] dial to choose [Yes], and then press the [SET] button.
- The information set here will now be recorded in images.



- To check the information entered, choose [Display Copyright Info] on the screen above, and then press the [SET] button.

## Deleting All Copyright Information

You can delete both the author's name and copyright details at the same time as follows.

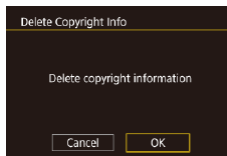

- Follow the steps in “Setting Copyright Information to Record in Images” (📖175) and choose [Delete Copyright Info].
- Press the [◀][▶] buttons or turn the [DISP] dial to choose [OK], and then press the [SET] button.



- The copyright info already recorded in images will not be deleted.

Before Use

Basic Guide

Advanced Guide

Camera Basics

Auto Mode / Hybrid Auto Mode

Other Shooting Modes

P Mode

Tv, Av, M, and C Mode

Playback Mode

Wi-Fi Functions

Setting Menu

Accessories

Appendix

Index



## Adjusting Other Settings

The following settings can also be adjusted.

- [Wireless settings] on the [4] tab (141)

## Restoring Default Camera Settings

If you accidentally change a setting, you can restore default camera settings.

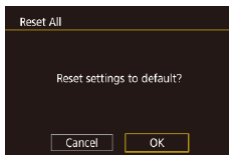

### 1 Access the [Reset All] screen.

- Choose [Reset All] on the [4] tab, and then press the [Reset] button.

### 2 Restore default settings.

- Press the [Left] [Right] buttons or turn the [Dial] dial to choose [OK], and then press the [Reset] button.
- Default settings are now restored.



- The following functions are not restored to default settings.
  - Information registered using Face ID (45)
  - [1] tab setting [Video system] (170)
  - [2] tab settings [Time Zone] (172), [Date/Time] (172), and [3] tab setting [Language] (173)
  - Custom white balance data you have recorded (83)
  - Shooting Mode
  - Exposure compensation (78) setting
  - Movie mode (72)
  - Wi-Fi settings (141)
  - Calibrated value for the electronic level (170)
  - Copyright information (175)

Before Use

Basic Guide

Advanced Guide

Camera Basics

Auto Mode /  
Hybrid Auto Mode

Other Shooting Modes

P Mode

Tv, Av, M, and C Mode

Playback Mode

Wi-Fi Functions

Setting Menu

Accessories

Appendix

Index



# Accessories

Enjoy the camera in more ways with optional Canon accessories and other compatible accessories sold separately

### Use of genuine Canon accessories is recommended.

This product is designed to achieve excellent performance when used with genuine Canon accessories. Canon shall not be liable for any damage to this product and/or accidents such as fire, etc., caused by the malfunction of non-genuine Canon accessories (e.g., a leakage and/or explosion of a battery pack). Please note that any repairs your Canon product may require as a result of such malfunction are not covered under warranty and will incur a fee. We appreciate your understanding in advance.

## System Map

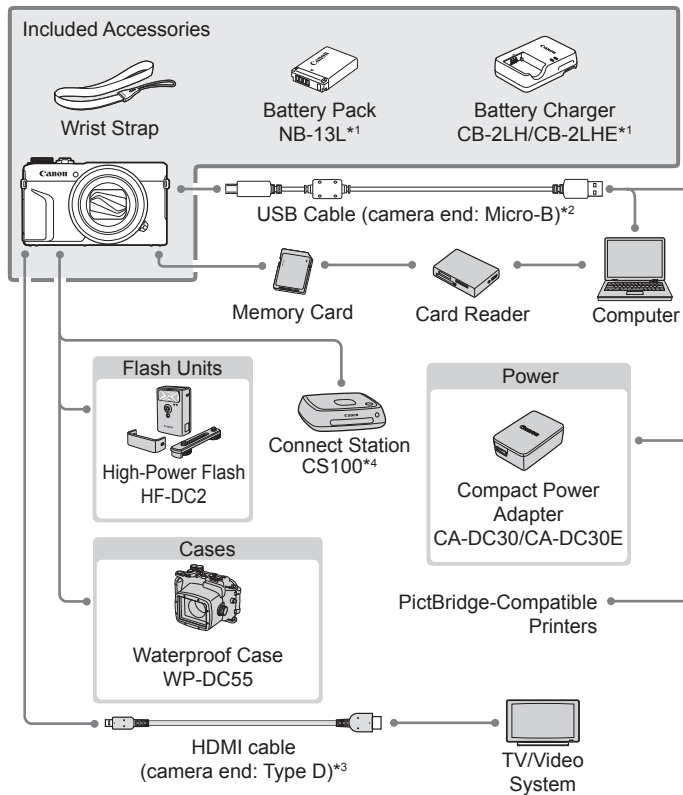

\*1 Also available for purchase separately.

\*2 A genuine Canon accessory is also available (Interface Cable IFC-600PCU).

\*3 Use a commercially available cable no longer than 2.5 m (8.2 ft.).

\*4 Use the latest firmware version.

Before Use

Basic Guide

Advanced Guide

Camera Basics

Auto Mode / Hybrid Auto Mode

Other Shooting Modes

P Mode

Tv, Av, M, and C Mode

Playback Mode

Wi-Fi Functions

Setting Menu

Accessories

Appendix

Index



## Optional Accessories

The following camera accessories are sold separately. Note that some accessories may no longer be available. Also, the availability may vary depending on the region.

### Power Supplies

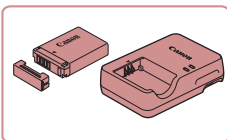

#### Battery Pack NB-13L

- Rechargeable lithium-ion battery

#### Battery Charger CB-2LH/CB-2LHE

- Charger for Battery Pack NB-13L



- The message [Battery communication error.] is displayed if you use a non-genuine Canon battery pack, and user response is required. Note that Canon shall not be liable for any damages resulting from accidents, such as malfunction or fire, that occur due to use of non-genuine Canon battery packs.
- The charger can be used in areas with 100 – 240 V AC power (50/60 Hz).
- For power outlets in a different format, use a commercially available adapter for the plug. Never use an electrical transformer designed for traveling, which may damage the battery pack.



- The battery pack includes a convenient cover which you can attach to know the charge status at a glance. Attach the cover so that ▲ is visible on a charged battery pack, and attach it so that ▲ is not visible on an uncharged battery pack.

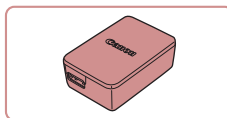

#### Compact Power Adapter CA-DC30/ CA-DC30E

- Insert the included battery pack into the camera for charging. Interface Cable IFC-600PCU (sold separately) is required to connect the adapter to the camera.

### Flash

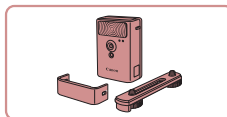

#### High-Power Flash HF-DC2

- External flash for illuminating subjects that are out of range of the built-in flash. High-Power Flash HF-DC1 can also be used.

### Other Accessories

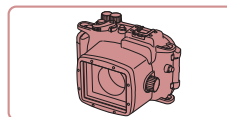

#### Waterproof Case WP-DC55

- For underwater photography at depths of up to 40 meters (130 ft.). Also useful for shooting in the rain, at the beach, or on ski slopes.

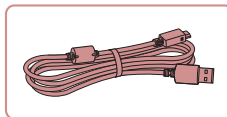

#### Interface Cable IFC-600PCU

- For connecting the camera to a computer or printer.

Before Use

Basic Guide

Advanced Guide

Camera Basics

Auto Mode /  
Hybrid Auto Mode

Other Shooting Modes

P Mode

Tv, Av, M, and C Mode

Playback Mode

Wi-Fi Functions

Setting Menu

Accessories

Appendix

Index



## Printers

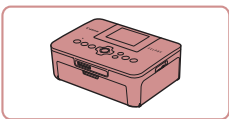

### Canon-Brand PictBridge-Compatible Printers

- Even without using a computer, you can print images by connecting the camera directly to a printer. For details, visit your nearest Canon retailer.

## Photo and Movie Storage

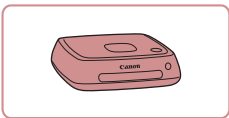

### Connect Station CS100

- A media hub for storing camera images, viewing on a connected TV, printing wirelessly on a Wi-Fi-compatible printer, sharing over the Internet, and more.

## Using Optional Accessories

### Playback on a TV

▶ Still Images ▶ Movies

You can view your shots on a TV by connecting the camera to an HDTV with a commercially available HDMI cable (not exceeding 2.5 m / 8.2 ft., with a Type D terminal on the camera end). Movies shot at an image quality of [FHD 59.94P], [FHD 29.97P], [FHD 23.98P], [FHD 29.97P], [FHD 50.00P], [FHD 25.00P], or [FHD 25.00P] can be viewed in high definition.

For details on connection or how to switch inputs, refer to the TV manual.

**1** Make sure the camera and TV are off.

**2** Connect the camera to the TV.

- On the TV, insert the cable plug fully into the HDMI input as shown.

- On the camera, open the terminal cover and insert the cable plug fully into the camera terminal.

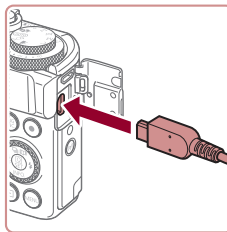
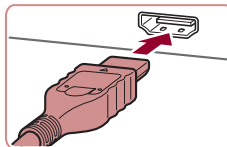

Before Use

Basic Guide

Advanced Guide

Camera Basics

Auto Mode /  
Hybrid Auto Mode

Other Shooting Modes

P Mode

Tv, Av, M, and C Mode

Playback Mode

Wi-Fi Functions

Setting Menu

Accessories

Appendix

Index



### 3 Turn the TV on and switch to external input.

- Switch the TV input to the external input you connected the cable to in step 2.



### 4 Turn the camera on.

- Press the [▶] button.
- Images from the camera are now displayed on the TV. (Nothing is displayed on the camera screen.)
- When finished, turn off the camera and TV before disconnecting the cable.



- Touch-screen operations are not supported while the camera is connected to a television.



- Some information may not be available when using a TV as the display (198).
- Camera operating sounds are not played while the camera is connected to an HDTV.
- When the camera and TV are connected, you can also shoot while previewing shots on the larger screen of the TV. To shoot, follow the same steps as when using the camera screen. However, MF-Point Zoom (87), MF Peaking (88) and Night Display (172) are not available.

## Inserting and Charging the Battery Pack

Charge the battery pack by using the supplied battery pack with an optional Compact Power Adapter CA-DC30/CA-DC30E and Interface Cable IFC-600PCU.

### 1 Insert the battery pack.

- Follow step 1 in “Inserting the Battery Pack and Your Memory Card” (19) to open the cover.
- Insert the battery pack as described in step 2 of “Inserting the Battery Pack and Your Memory Card” (19).
- Follow step 4 in “Inserting the Battery Pack and Your Memory Card” (19) to close the cover.

### 2 Connect the compact power adapter to the camera.

- With the camera turned off, open the cover (1). Hold the smaller plug of the interface cable (sold separately) facing as shown and insert the plug fully into the camera terminal (2).
- Insert the larger plug of the interface cable into the compact power adapter.

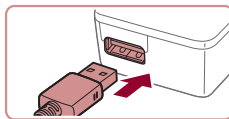
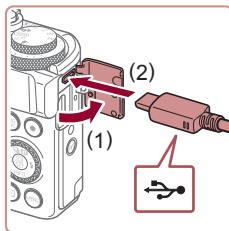

Before Use

Basic Guide

Advanced Guide

Camera Basics

Auto Mode /  
Hybrid Auto Mode

Other Shooting Modes

P Mode

Tv, Av, M, and C Mode

Playback Mode

Wi-Fi Functions

Setting Menu

Accessories

Appendix

Index





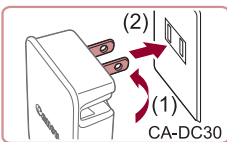

### 3 Charge the battery pack.

- **CA-DC30:** Flip out the plug (1) and plug the compact power adapter into a power outlet (2).
- **CA-DC30E:** Plug the power cord into the compact power adapter, then plug the other end into a power outlet.

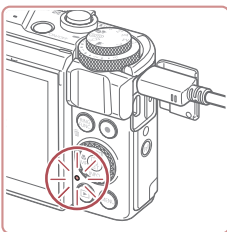
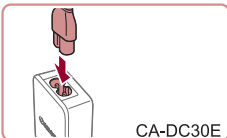

- Charging begins and the USB charge lamp lights up.
- The lamp turns off when charging finishes.
- Remove the compact power adapter from the power outlet and the interface cable from the camera.



- To protect the battery pack and keep it in optimal condition, do not charge it continuously for more than 24 hours.
- When charging another battery, ensure that the interface cable is removed from the camera before replacing the battery to charge.



- For details on charging time and the number of shots and recording time possible with a fully charged battery pack, see “Number of Shots/Recording Time, Playback Time” (180).
- You can view images even while the battery is charging, by turning the camera on and entering Playback mode (124). However, you cannot shoot while the battery is charging.
- If the USB charge lamp does not light up, remove the interface cable and insert the cable again.
- Charged battery packs gradually lose their charge, even when they are not used. Charge the battery pack on (or immediately before) the day of use.
- The charger can be used in areas with 100 – 240 V AC power (50/60 Hz). For power outlets in a different format, use a commercially available adapter for the plug. Never use an electrical transformer designed for traveling, which may damage the battery pack.

### Using a Computer to Charge the Battery

You can also charge the battery pack by inserting the larger plug of the interface cable into a computer’s USB terminal in step 2 of “Inserting and Charging the Battery Pack” (180). For details about USB connections on the computer, refer to the computer user manual.



- Charging is not possible when the camera is off.
- With some computers, battery charging may require the memory card to be in the camera. Insert the memory card in the camera (119) before connecting the cable to the computer’s USB port.

Before Use

Basic Guide

Advanced Guide

Camera Basics

Auto Mode / Hybrid Auto Mode

Other Shooting Modes

P Mode

Tv, Av, M, and C Mode

Playback Mode

Wi-Fi Functions

Setting Menu

Accessories

Appendix

Index



## Using the Software

To utilize the features of the following software, download the software from the Canon website and install it on your computer.

- CameraWindow
  - Import images to your computer
  - Register Picture Styles saved on the computer to the camera
- Image Transfer Utility
  - Set up Image Sync (📖162) and receive images
- Map Utility
  - Use a map to view GPS information that has been added to images
- Digital Photo Professional
  - Browse, process and edit RAW images
- Picture Style Editor
  - Edit Picture Styles and create and save Picture Style files



- To view and edit movies on a computer, use preinstalled or commonly available software compatible with movies recorded by the camera.



- Image Transfer Utility can also be downloaded from the Image Sync settings page of CANON IMAGE GATEWAY.

## Computer Connections via a Cable

### Checking Your Computer Environment

For detailed system requirements and compatibility information on computers for using the software, including support for new operating systems, visit the Canon website.

### Installing the Software

For software installation instructions, see “Installing the Software” (📖147).

## Saving Images to a Computer

Using a USB cable (sold separately; camera end: Micro-B), you can connect the camera to the computer and save images to the computer.

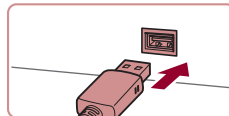
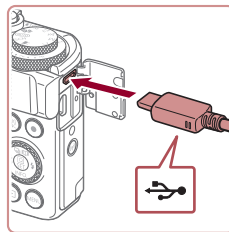

### 1 Connect the camera to the computer.

- With the camera turned off, open the cover. With the smaller plug of the cable in the orientation shown, insert the plug fully into the camera terminal.
- Connect the larger cable plug to the computer. For details on computer connections, refer to the computer user manual.

Before Use

Basic Guide

Advanced Guide

Camera Basics

Auto Mode /  
Hybrid Auto Mode

Other Shooting Modes

P Mode

Tv, Av, M, and C Mode

Playback Mode

Wi-Fi Functions

Setting Menu

Accessories

Appendix

Index



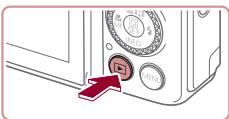

## 2 Turn the camera on to access CameraWindow.

- Press the [▶] button.
- Mac OS: CameraWindow is displayed when a connection is established between the camera and computer.
- Windows: Follow the steps introduced below.
- In the screen that is displayed, click the change program link of [📷].
- Choose [Downloads Images From Canon Camera] and then click [OK].

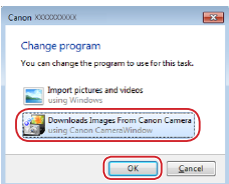

- Double-click [📷].

## 3 Save the images to the computer.

- Click [Import Images from Camera], and then click [Import Untransferred Images].
- Images are now saved to the Pictures folder on the computer, in separate folders named by date.
- After images are saved, close CameraWindow, press the [▶] button to turn the camera off, and unplug the cable.
- To view images you save to a computer, use preinstalled or commonly available software compatible with images captured by the camera.

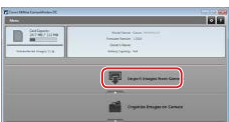

- Windows 7: If the screen in step 2 is not displayed, click the [📷] icon in the taskbar.
- Mac OS: If CameraWindow is not displayed after step 2, click the [CameraWindow] icon in the Dock.
- Although you can save images to a computer simply by connecting your camera to the computer without using the software, the following limitations apply.
  - It may take a few minutes after you connect the camera to the computer until camera images are accessible.
  - Images shot in vertical orientation may be saved in horizontal orientation.
  - RAW images (or JPEG images recorded with RAW images) may not be saved.
  - Image protection settings may be cleared from images saved to a computer.
  - Some problems may occur when saving images or image information, depending on the operating system version, the software in use, or image file sizes.

Before Use

Basic Guide

Advanced Guide

Camera Basics

Auto Mode /  
Hybrid Auto Mode

Other Shooting Modes

P Mode

Tv, Av, M, and C Mode

Playback Mode

Wi-Fi Functions

Setting Menu

Accessories

Appendix

Index



## Printing Images

▶ Still Images ▶ Movies

Print your shots and configure a variety of settings used for your printer or photo printing services by connecting the camera to a PictBridge-compatible printer with a cable.

A Canon SELPHY CP printer is used in this example of PictBridge printing. Also refer to your printer user manual.

### Easy Print

▶ Still Images ▶ Movies

Print your shots by connecting the camera to a PictBridge-compatible printer with a USB cable (sold separately; camera end: Micro-B).

#### 1 Make sure the camera and printer are off.

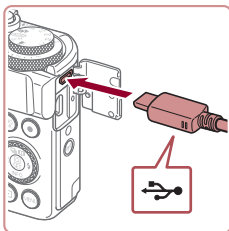

#### 2 Connect the camera to the printer.

- Open the terminal cover. Holding the smaller cable plug in the orientation shown, insert the plug fully into the camera terminal.
- Connect the larger cable plug to the printer. For other connection details, refer to the printer manual.

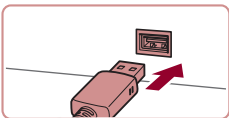

#### 3 Turn the printer on.

#### 4 Choose an image.

- Press the [◀][▶] buttons or turn the [DISP.] dial to choose an image.

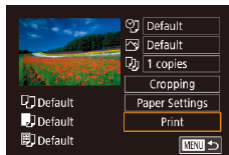
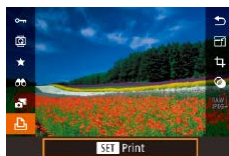

#### 5 Access the printing screen.

- Press the [DISP.] button, choose [▶], and press the [DISP.] button again.

#### 6 Print the image.

- Press the [▲][▼] buttons or turn the [DISP.] dial to choose [Print], and then press the [DISP.] button.
- Printing now begins.
- To print other images, repeat the above procedures starting from step 4 after printing is finished.
- When you are finished printing, turn the camera and printer off and disconnect the cable.



- For Canon-brand PictBridge-compatible printers (sold separately), see "Printers" (179).

Before Use

Basic Guide

Advanced Guide

Camera Basics

Auto Mode /  
Hybrid Auto Mode

Other Shooting Modes

P Mode

Tv, Av, M, and C Mode

Playback Mode

Wi-Fi Functions

Setting Menu

Accessories

Appendix

Index



## Configuring Print Settings

▶ Still Images ▶ Movies

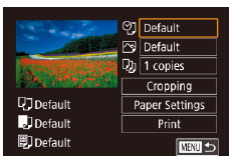

### 1 Access the printing screen.

- Follow steps 1 – 5 in “Easy Print” (184) to access this screen.

### 2 Configure the settings.

- Press the [▲][▼] buttons or turn the [DISP] dial to choose an item, and then press the [SET] button. On the next screen, choose an option (either press the [▲][▼] buttons or turn the [DISP] dial), and then press the [SET] button to return to the printing screen.

🗨️	Default	Matches current printer settings.
	Date	Prints images with the date added.
	File No.	Prints images with the file number added.
	Both	Prints images with both the date and file number added.
📄	Off	–
	On	Uses information from the time of shooting to print under optimal settings.
	Red-Eye1	Corrects red-eye.
🖨️	No. of Copies	Choose the number of copies to print.
Cropping	–	Specify a desired image area to print (185).
Paper Settings	–	Specify the paper size, layout, and other details (186).

## Cropping Images before Printing

▶ Still Images ▶ Movies

By cropping images before printing, you can print a desired image area instead of the entire image.

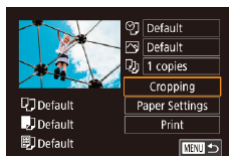

### 1 Choose [Cropping].

- After following step 1 in “Configuring Print Settings” (185) to access the printing screen, choose [Cropping] and press the [SET] button.
- A cropping frame is now displayed, indicating the image area to print.

### 2 Adjust the cropping frame as needed.

- To resize the frame, move the zoom lever.
- To move the frame, press the [▲][▼][◀][▶] buttons.
- To rotate the frame, turn the [DISP] dial.
- When finished, press the [SET] button.

### 3 Print the image.

- Follow step 6 in “Easy Print” (184) to print.



- Cropping may not be possible at small image sizes, or at some aspect ratios.

Before Use

Basic Guide

Advanced Guide

Camera Basics

Auto Mode / Hybrid Auto Mode

Other Shooting Modes

P Mode

Tv, Av, M, and C Mode

Playback Mode

Wi-Fi Functions

Setting Menu

Accessories

Appendix

Index



## Choosing Paper Size and Layout before Printing

▶ Still Images ▶ Movies

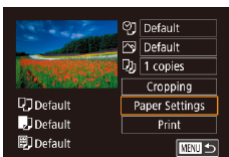

### 1 Choose [Paper Settings].

- After following step 1 in “Configuring Print Settings” (185) to access the printing screen, choose [Paper Settings] and press the [OK] button.

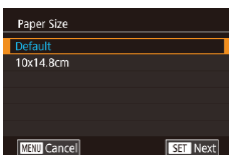

### 2 Choose a paper size.

- Press the [▲][▼] buttons or turn the [DIAL] dial to choose an option, and then press the [OK] button.

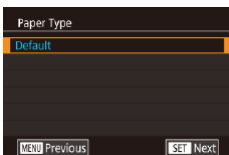

### 3 Choose a type of paper.

- Press the [▲][▼] buttons or turn the [DIAL] dial to choose an option, and then press the [OK] button.

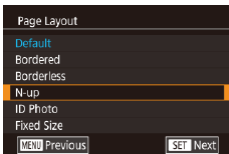

### 4 Choose a layout.

- Press the [▲][▼] buttons or turn the [DIAL] dial to choose an option.
- When choosing [N-up], press the [OK] button. On the next screen, choose the number of images per sheet (either press the [▲][▼] buttons or turn the [DIAL] dial), and then press the [OK] button.

### 5 Print the image.

## Available Layout Options

Default	Matches current printer settings.
Bordered	Prints with blank space around the image.
Borderless	Borderless, edge-to-edge printing.
N-up	Choose how many images to print per sheet.
ID Photo	Prints images for identification purposes. Only available for images with a recording pixel setting of L and an aspect ratio of 3:2.
Fixed Size	Choose the print size. Choose from 3.5 x 5 in., postcard, or wide-format prints.

## Printing ID Photos

▶ Still Images ▶ Movies

### 1 Choose [ID Photo].

- Following steps 1 – 4 in “Choosing Paper Size and Layout before Printing” (186), choose [ID Photo] and press the [OK] button.



### 2 Choose the long and short side length.

- Press the [▲][▼] buttons or turn the [DIAL] dial to choose an item, and then press the [OK] button. On the next screen, choose the length (either press the [▲][▼] buttons or turn the [DIAL] dial), and then press the [OK] button.

Before Use

Basic Guide

Advanced Guide

Camera Basics

Auto Mode /  
Hybrid Auto Mode

Other Shooting Modes

P Mode

Tv, Av, M, and C Mode

Playback Mode

Wi-Fi Functions

Setting Menu

Accessories

Appendix

Index





### 3 Choose the printing area.

- Press the [▲][▼] buttons or turn the [DISP] dial to choose [Cropping], and then press the [SET] button.
- Follow step 2 in “Cropping Images before Printing” (📖185) to choose the printing area.

### 4 Print the image.

## ■ Printing Movie Scenes

▶ Still Images ▶ Movies

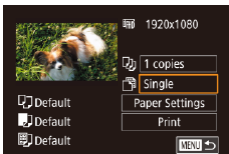

### 1 Access the printing screen.

- Follow steps 1 – 5 in “Easy Print” (📖184) to choose a movie. The screen at left is displayed.

### 2 Choose a printing method.

- Press the [▲][▼] buttons to choose [Print], and then press the [SET] button. On the next screen, choose an option (either press the [▲][▼] buttons or turn the [DISP] dial), and then press the [SET] button to return to the printing screen.

### 3 Print the image.

## Movie Printing Options

Single	Prints the current scene as a still image.
Sequence	Prints a series of scenes, a certain interval apart, on a single sheet of paper. You can also print the folder number, file number, and elapsed time for the frame by setting [Caption] to [On].



- To cancel printing in progress, press the [DISP] button, choose [OK], and then press the [SET] button again.
- After displaying a scene to print as described in steps 2 – 5 of “Viewing” (📖110), you can also access the screen in step 1 here by pressing the [◀][▶] buttons to choose [Print] in the movie control panel and then pressing the [SET] button.

## ■ Adding Images to the Print List (DPOF)

▶ Still Images ▶ Movies

Batch printing (📖189) and ordering prints from a photo development service can be set up on the camera. Choose up to 998 images on a memory card and configure relevant settings, such as the number of copies, as follows. The printing information you prepare this way will conform to DPOF (Digital Print Order Format) standards.



- RAW images cannot be included in print list.

Before Use

Basic Guide

Advanced Guide

Camera Basics

Auto Mode / Hybrid Auto Mode

Other Shooting Modes

P Mode

Tv, Av, M, and C Mode

Playback Mode

Wi-Fi Functions

Setting Menu

Accessories

Appendix

Index



## Configuring Print Settings

▶ Still Images ▶ Movies

Specify the printing format, whether to add the date or file number, and other settings as follows. These settings apply to all images in the print list.

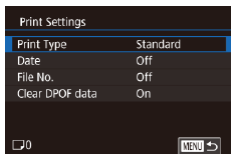

- Press the [MENU] button, choose [Print settings] on the [▶]4 tab, and then press the [OK] button.
- Press the [▲][▼] buttons or turn the [DISP] dial to choose [Print Settings], and then press the [OK] button. On the next screen, choose and configure items as needed (📖30).

Print Type	Standard	One image is printed per sheet.
	Index	Smaller versions of multiple images are printed per sheet.
	Both	Both standard and index formats are printed.
Date	On	Images are printed with the shooting date.
	Off	–
File No.	On	Images are printed with the file number.
	Off	–
Clear DPOF data	On	All image print list settings are cleared after printing.
	Off	–



- Not all of your DPOF settings may be applied in printing by the printer or photo development service, in some cases.
- [!] may be displayed on the camera to warn you that the memory card has print settings that were configured on another camera. Changing the print settings using this camera may overwrite all previous settings.



- Specifying [Index] will prevent you from choosing [On] for both [Date] and [File No.] at the same time.
- Index printing is not available on some Canon-brand PictBridge-compatible printers (sold separately).
- The date is printed in a format matching setting details in [Date/Time] on the [▶]2 tab (📖21).

## Setting Up Printing for Individual Images

▶ Still Images ▶ Movies

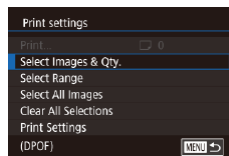

### 1 Choose [Select Images & Qty.].

- Press the [MENU] button, choose [Print settings] on the [▶]4 tab, and then press the [OK] button.
- Press the [▲][▼] buttons or turn the [DISP] dial to choose [Select Images & Qty.], and then press the [OK] button (📖30).

### 2 Choose an image.

- Press the [◀][▶] buttons or turn the [DISP] dial to choose an image, and then press the [OK] button.
- You can now specify the number of copies.
- If you specify index printing for the image, it is labeled with a [✓] icon. To cancel index printing for the image, press the [OK] button again. [✓] is no longer displayed.

Before Use

Basic Guide

Advanced Guide

Camera Basics

Auto Mode / Hybrid Auto Mode

Other Shooting Modes

P Mode

Tv, Av, M, and C Mode

Playback Mode

Wi-Fi Functions

Setting Menu

Accessories

Appendix

Index







### 3 Specify the number of prints.

- Press the [▲][▼] buttons or turn the [DISP] dial to specify the number of prints (up to 99).
- To set up printing for other images and specify the number of prints, repeat steps 2 – 3.
- Printing quantity cannot be specified for index prints. You can only choose which images to print, by following step 2.
- When finished, press the [MENU] button to return to the menu screen.

## Setting Up Printing for a Range of Images

▶ Still Images ▶ Movies

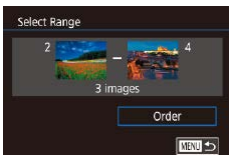

- Following step 1 in “Setting Up Printing for Individual Images” (📖188), choose [Select Range] and press the [DISP] button.
- Follow steps 2 – 3 in “Selecting a Range” (📖122) to specify images.
- Press the [▲][▼] buttons to choose [Order], and then press the [DISP] button.

## Setting Up Printing for All Images

▶ Still Images ▶ Movies

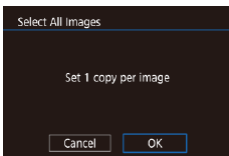

- Following step 1 in “Setting Up Printing for Individual Images” (📖188), choose [Select All Images] and press the [DISP] button.
- Press the [◀][▶] buttons or turn the [DISP] dial to choose [OK], and then press the [DISP] button.

## Clearing All Images from the Print List

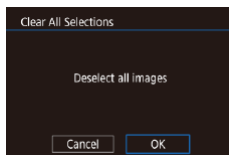

- Following step 1 in “Setting Up Printing for Individual Images” (📖188), choose [Clear All Selections] and press the [DISP] button.
- Press the [◀][▶] buttons or turn the [DISP] dial to choose [OK], and then press the [DISP] button.

## Printing Images Added to the Print List (DPOF)

▶ Still Images ▶ Movies

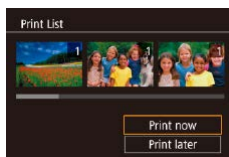

- When images have been added to the print list (📖187 – 📖189), this screen is displayed after you connect the camera to a PictBridge-compatible printer. Press the [▲][▼] buttons to choose [Print now], and then simply press the [DISP] button to print the images in the print list.
- Any DPOF print job that you temporarily stop will be resumed from the next image.

Before Use

Basic Guide

Advanced Guide

Camera Basics

Auto Mode /  
Hybrid Auto Mode

Other Shooting Modes

P Mode

Tv, Av, M, and C Mode

Playback Mode

Wi-Fi Functions

Setting Menu

Accessories

Appendix

Index



## Adding Images to a Photobook

▶ Still Images ▶ Movies

Photobooks can be set up on the camera by choosing up to 998 images on a memory card and using CameraWindow to import them to your computer (182), where they are copied to their own folder. This is convenient when ordering printed photobooks online or printing photobooks with your own printer.

### Choosing a Selection Method

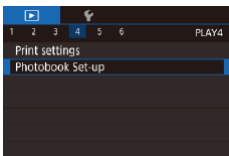

- Press the [MENU] button, choose [Photobook Set-up] on the [▶] tab, and then choose how you will select images.



- [!] may be displayed on the camera to warn you that the memory card has print settings that were configured on another camera. Changing the print settings using this camera may overwrite all previous settings.

### Adding Images Individually

▶ Still Images ▶ Movies

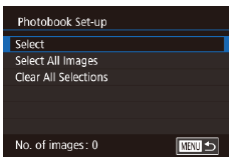

#### 1 Choose [Select].

- Following the procedure in “Choosing a Selection Method” (190), choose [Select] and press the [OK] button.



#### 2 Choose an image.

- Press the [◀][▶] buttons or turn the [DIAL] dial to choose an image, and then press the [OK] button.
- [✓] is displayed.
- To remove the image from the photobook, press the [OK] button again. [✓] is no longer displayed.
- Repeat this process to specify other images.
- When finished, press the [MENU] button to return to the menu screen.

### Adding All Images to a Photobook

▶ Still Images ▶ Movies

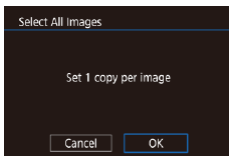

- Following the procedure in “Choosing a Selection Method” (190), choose [Select All Images] and press the [OK] button.
- Press the [◀][▶] buttons or turn the [DIAL] dial to choose [OK], and then press the [OK] button.

### Removing All Images from a Photobook

▶ Still Images ▶ Movies

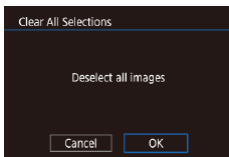

- Following the procedure in “Choosing a Selection Method” (190), choose [Clear All Selections] and press the [OK] button.
- Press the [◀][▶] buttons or turn the [DIAL] dial to choose [OK], and then press the [OK] button.

Before Use

Basic Guide

Advanced Guide

Camera Basics

Auto Mode /  
Hybrid Auto Mode

Other Shooting Modes

P Mode

Tv, Av, M, and C Mode

Playback Mode

Wi-Fi Functions

Setting Menu

Accessories

Appendix

Index



# Appendix

Helpful information when using the camera

## Troubleshooting

If you think there is a problem with the camera, first check the following. If the items below do not solve your problem, contact a Canon Customer Support Help Desk.

### Power

Nothing happens when the power button is pressed.

- Confirm that the battery pack is charged (18).
- Confirm that the battery pack is inserted facing the correct way (19).
- Confirm that the memory card/battery cover is fully closed (19).
- Dirty battery terminals reduce battery performance. Try cleaning the terminals with a cotton swab and reinserting the battery pack a few times.

The battery pack runs out of power quickly.

- Battery performance decreases at low temperatures. Try warming the battery pack a little by putting it in your pocket, for example, ensuring that the terminals do not touch any metal objects.
- Dirty battery terminals reduce battery performance. Try cleaning the terminals with a cotton swab and reinserting the battery pack a few times.
- If these measures do not help and the battery pack still runs out of power soon after charging, it has reached the end of its life. Purchase a new battery pack.

The lens is not retracted.

- Do not open the memory card/battery cover while the camera is on. Close the cover, turn the camera on, and then turn it off again (19).

The battery pack is swollen.

- Battery swelling is normal and does not pose any safety concerns. However, if battery swelling prevents the battery pack from fitting in the camera, contact a Canon Customer Support Help Desk.

### Display on a TV

Camera images look distorted or are not displayed on a TV (179).

Before Use

Basic Guide

Advanced Guide

Camera Basics

Auto Mode /  
Hybrid Auto Mode

Other Shooting Modes

P Mode

Tv, Av, M, and C Mode

Playback Mode

Wi-Fi Functions

Setting Menu

Accessories

Appendix

Index



## Shooting

Cannot shoot.

- In Playback mode (📖110), press the shutter button halfway (📖27).

Strange display on the screen under low light (📖29).

Strange display on the screen when shooting.

- Note that the following display problems are not recorded in still images but are recorded in movies.
  - The screen may flicker and horizontal banding may appear under fluorescent or LED lighting.

Full-screen display is not available while shooting (📖97).

⚡ flashes on the screen when the shutter button is pressed, and shooting is not possible (📖37).

📷 is displayed when the shutter button is pressed halfway (📖37).

- Set [IS Mode] to [Continuous] (📖52).
- Raise the flash and set the flash mode to ⚡ (📖95).
- Increase the ISO speed (📖80).
- Mount the camera on a tripod or take other measures to keep it still. Additionally, you should set [IS Mode] to [Off] when using a tripod or other means to secure the camera (📖52).

Shots are out of focus.

- Press the shutter button halfway to focus on subjects before pressing it all the way down to shoot (📖27).
- Make sure subjects are within focusing range (📖219).
- Set [AF-assist Beam] to [On] (📖53).
- Confirm that unneeded functions such as macro are deactivated.
- Try shooting with focus lock or AF lock (📖90, 📖94).

Shots are blurry.

- Blurring may occur more often when Touch Shutter is used to shoot, depending on shooting conditions. Hold the camera still when shooting.

No AF frames are displayed and the camera does not focus when the shutter button is pressed halfway.

- To have AF frames displayed and the camera focus correctly, try composing the shot with higher-contrast subject areas centered before you press the shutter button halfway. Otherwise, try pressing the shutter button halfway repeatedly.

Subjects in shots look too dark.

- Raise the flash and set the flash mode to ⚡ (📖95).
- Adjust brightness by using exposure compensation (📖78).
- Adjust brightness by using the Auto Lighting Optimizer (📖81).
- Use AE lock or spot metering (📖78, 📖79).

Subjects look too bright, highlights are washed-out.

- Lower the flash and set the flash mode to ☀️ (📖34).
- Adjust brightness by using exposure compensation (📖78).
- Use AE lock or spot metering (📖78, 📖79).
- Reduce the lighting on subjects.

Shots look too dark despite the flash firing (📖37).

- Shoot within flash range (📖217).
- Adjust brightness by using flash exposure compensation or changing the flash output level (📖96, 📖103).
- Increase the ISO speed (📖80).

Subjects in flash shots look too bright, highlights are washed-out.

- Shoot within flash range (📖217).
- Lower the flash and set the flash mode to ☀️ (📖34).
- Adjust brightness by using flash exposure compensation or changing the flash output level (📖96, 📖103).

White spots appear in flash shots.

- This is caused by light from the flash reflecting off dust or airborne particles.

Shots look grainy.

- Lower the ISO speed (📖80).
- High ISO speeds in some shooting modes may cause grainy images (📖55).

Subjects are affected by red-eye.

- Set [Red-Eye Lamp] to [On] (📖54). The red-eye reduction lamp (📖4) will light up for flash shots. For best results, have subjects look at the red-eye reduction lamp. Also try increasing the lighting in indoor scenes and shooting at closer range.
- Edit images using red-eye correction (📖131).

Before Use

Basic Guide

Advanced Guide

Camera Basics

Auto Mode /  
Hybrid Auto Mode

Other Shooting Modes

P Mode

Tv, Av, M, and C Mode

Playback Mode

Wi-Fi Functions

Setting Menu

Accessories

Appendix

Index



Recording to the memory card takes too long, or continuous shooting is slower.

- Use the camera to perform low-level formatting of the memory card (📖169).

Shooting settings or Quick Set menu settings are not available.

- Available setting items vary by shooting mode. Refer to "Functions Available in Each Shooting Mode", "Quick Set Menu", and "Shooting Tab" (📖200 – 📖206).

The Babies or Children icon is not displayed.

- The Babies and Children icons will not be displayed if the birthday is not set in face information (📖45). If the icons still are not displayed even when you set the birthday, re-register face information (📖45), or make sure that the date/time is set correctly (📖172).

Touch AF or Touch Shutter does not work.

- Touch AF or Touch Shutter will not work if you touch the edges of the screen. Touch closer to the center of the screen.

## Shooting Movies

The elapsed time shown is incorrect, or recording is interrupted.

- Use the camera to format the memory card, or switch to a card that supports high-speed recording. Note that even if the elapsed time display is incorrect, the length of movies on the memory card corresponds to the actual recording time (📖169, 📖220).

🚫 is displayed and shooting stops automatically.

- The camera's internal memory buffer filled up as the camera could not record to the memory card quickly enough. Try one of the following measures.
  - Use the camera to perform low-level formatting of the memory card (📖169).
  - Lower the image quality (📖50).
  - Switch to a memory card that supports high-speed recording (📖220).

Zooming is not possible.

- Zooming is not possible in 📷 mode (📖65).
- Zooming is not possible when shooting movies in 📹 (📖62) and 📺 (📖74) modes.

Subjects look distorted.

- Subjects that pass in front of the camera quickly may look distorted. This is not a malfunction.

Linear noise is recorded.

- Linear noise may be recorded if lights or other sources of bright light are visible on the shooting screen in an otherwise dark scene. Recompose the shot so that the bright light source is not visible on the shooting screen or nearby.

## Playback

Playback is not possible.

- Image or movie playback may not be possible if a computer is used to rename files or alter the folder structure.

Playback stops, or audio skips.

- Switch to a memory card that you have performed low-level formatting on with the camera (📖169).
- There may be brief interruptions when playing movies copied to memory cards that have slow read speeds.
- When movies are played on a computer, frames may be dropped and audio may skip if computer performance is inadequate.

Sound is not played during movies.

- Adjust the volume (📖24) if you have activated [Mute] (📖173) or the sound in the movie is faint.
- No sound is played for movies shot in 📹 (📖62), 📺 (📖68, 📖74), or 📺 (📖74) mode because audio is not recorded in these modes.

Cannot access the Story Highlights home screen by pressing the [▲] button.

- Home screen display is not possible when connected to a printer. Disconnect the camera from the printer.
- Home screen display is not possible during Wi-Fi connections. End the Wi-Fi connection.

A desired subject icon for an album is not displayed on the Story Highlights home screen.

- In simple information display mode (📖112), choose an image that shows the name of the person for the album before accessing the Story Highlights home screen (📖136).

## Memory Card

The memory card is not recognized.

- Restart the camera, with the memory card in it (📖26).

Before Use

Basic Guide

Advanced Guide

Camera Basics

Auto Mode / Hybrid Auto Mode

Other Shooting Modes

P Mode

Tv, Av, M, and C Mode

Playback Mode

Wi-Fi Functions

Setting Menu

Accessories

Appendix

Index



## Computer

### Cannot transfer images to a computer.

- When attempting to transfer images to the computer via a cable, try reducing the transfer speed as follows.
  - Press the [▶] button to enter Playback mode. Hold the [MENU] button down as you press the [▲] and [⊞] buttons at the same time. On the next screen, press the [◀][▶] buttons to choose [B], and then press the [⊞] button.

## Wi-Fi

### Cannot access the Wi-Fi menu by pressing the [Wi-Fi] button.

- The Wi-Fi menu cannot be accessed while the camera is connected to a printer or computer via a cable. Disconnect the cable.

### Cannot add a device/destination.

- A total of 20 items of connection information can be added to the camera. Erase unneeded connection information from the camera first, and then add new devices/destinations (165).
- Use a computer or smartphone to register Web services (153).
- To add a smartphone, first install the dedicated application Camera Connect on your smartphone (142).
- To add a computer, first install the software CameraWindow on your computer. Also check your computer and Wi-Fi environment and settings (147, 149).
- Do not use the camera near sources of Wi-Fi signal interference, such as microwave ovens, Bluetooth devices, or other equipment operating on the 2.4 GHz band.
- Bring the camera closer to the other device you are trying to connect to (such as the access point), and make sure there are no objects between the devices.

### Cannot connect to the access point.

- Confirm that the access point channel is set to a channel supported by the camera (217). Note that instead of auto channel assignment, it is advisable to specify a supported channel manually.

### Cannot send images.

- The destination device has insufficient storage space. Increase the storage space on the destination device and resend the images.
- The write-protect switch of the memory card in the destination camera is set to the locked position. Slide the write-protect switch to the unlocked position.
- RAW images cannot be sent. For images captured in both JPEG and RAW format, only the JPEG version is sent. However, RAW images can be sent using Image Sync.
- Images are not sent to CANON iIMAGE GATEWAY or other Web services if you move or rename image files or folders on the computer that received images sent using Image Sync via an access point (162). Before moving or renaming these image files or folders on the computer, make sure the images have already been sent to CANON iIMAGE GATEWAY or other Web services.

### Cannot resize images for sending.

- Images cannot be resized to be bigger than the recording pixel setting of their original size.
- Movies cannot be resized.

### Images take a long time to send./The wireless connection is disrupted.

- Multiple images may take a long time to send. Try resizing the image to reduce sending time (161).
- Movies may take a long time to send.
- Do not use the camera near sources of Wi-Fi signal interference, such as microwave ovens, Bluetooth devices, or other equipment operating on the 2.4 GHz band. Note that images may take a long time to send even when [Wi-Fi] is displayed.
- Bring the camera closer to the other device you are trying to connect to (such as the access point), and make sure there are no objects between the devices.

### No notification message is received on a computer or smartphone after adding CANON iIMAGE GATEWAY to the camera.

- Make sure the email address you entered is correct, and try adding the destination again.
- Check the email settings on the computer or smartphone. If they are configured to block email from certain domains, you may not be able to receive the notification message.

### Want to erase Wi-Fi connection information before disposing of the camera or giving it to someone else.

- Reset the Wi-Fi settings (167).

## Before Use

## Basic Guide

## Advanced Guide

### Camera Basics

### Auto Mode / Hybrid Auto Mode

### Other Shooting Modes

### P Mode

### Tv, Av, M, and C Mode

### Playback Mode

### Wi-Fi Functions

### Setting Menu

### Accessories

## Appendix

## Index



## On-Screen Messages

If an error message is displayed, respond as follows.

### Shooting or Playback

#### No memory card

- The memory card may be inserted facing the wrong way. Reinsert the memory card facing the correct way (119).

#### Memory card locked

- The write-protect switch of the memory card is set to the locked position. Switch the write-protect switch to the unlocked position (119).

#### Cannot record!

- Shooting was attempted without a memory card in the camera. To shoot, insert a memory card facing the correct way (119).

#### Memory card error (169)

- If the same error message is displayed even after you have formatted a supported memory card (12) and have inserted it facing the correct way (119), contact a Canon Customer Support Help Desk.

#### Insufficient space on card

- There is not enough free space on the memory card to shoot (34, 55, 77, 100) or edit images (128). Either erase unneeded images (123) or insert a memory card with enough free space (119).

#### Touch AF unavailable

- Touch AF is not available in the current shooting mode (200).

#### Touch AF canceled

- The subject selected for Touch AF can no longer be detected (93).

#### Charge the battery (18)

#### No Image.

- The memory card does not contain any images that can be displayed.

#### Protected! (121)

Unidentified Image/Incompatible JPEG/Image too large./Cannot play back MOV/Cannot play back MP4

- Unsupported or corrupt images cannot be displayed.
- It may not be possible to display images that were edited or renamed on a computer, or images shot with another camera.

Cannot magnify!/Cannot rotate/Cannot modify image/Cannot modify/ Cannot assign to category/Unselectable image./No identification information

- The following functions may be unavailable for images that were renamed or already edited on a computer, or images shot with another camera. Note that starred (\*) functions are not available for movies. Edit ID Info (118)\*, Magnify (119)\*, Rotate (125)\*, Favorites (126), Edit (128)\*, Print List (187)\*, and Photobook Set-up (190)\*.

#### Invalid selection range

- When specifying a range for image selection (122, 125, 189), you attempted to choose an initial image that was after the final image, or vice-versa.

#### Exceeded selection limit

- More than 998 images were selected for Print List (187) or Photobook Set-up (190). Choose 998 images or less.
- Print List (187) or Photobook Set-up (190) settings could not be saved correctly. Reduce the number of selected images and try again.
- You attempted to choose more than 500 images in Protect (121), Erase (123), Favorites (126), Print List (187), or Photobook Set-up (190).

#### Naming error!

- The folder could not be created or images could not be recorded, because the highest supported folder number (999) for storing images on the card has been reached and the highest supported image number (9999) for images in folders has been reached. On the [1] tab, change [File Numbering] to [Auto Reset] (168), or format the memory card (169).

#### Lens Error

- This error may occur if the lens is held while it is moving, or when the camera is used in dusty or sandy locations.
- Frequent display of this error message may indicate camera damage. In this case, contact a Canon Customer Support Help Desk.

Before Use

Basic Guide

Advanced Guide

Camera Basics

Auto Mode /  
Hybrid Auto Mode

Other Shooting Modes

P Mode

Tv, Av, M, and C Mode

Playback Mode

Wi-Fi Functions

Setting Menu

Accessories

Appendix

Index



### A camera error was detected (*error number*)

- If this error message is displayed immediately after a shot, the image may not have been saved. Switch to Playback mode to check for the image.
- Frequent display of this error message may indicate camera damage. In this case, write down the error number (*Exx*) and contact a Canon Customer Support Help Desk.

### File Error

- Correct printing (📖184) may not be possible for photos from other cameras or images that have been altered using computer software, even if the camera is connected to the printer.

### Print error

- Check the paper size setting (📖186). If this error message is displayed when the setting is correct, restart the printer and complete the setting on the camera again.

### Ink absorber full

- Contact a Canon Customer Support Help Desk to request assistance with ink absorber replacement.

## Wi-Fi

### Connection failed

- No access points were recognized. Check the access point settings (📖149).
- A device could not be found. Turn the camera off and on again, and retry the connection.
- Check the device you want to connect to and make sure it is ready for connection.

### Cannot determine access point

- The WPS buttons on numerous access points were pressed simultaneously. Try reconnecting again.

### No access points found

- Check to make sure that the access point is turned on.
- When connecting to an access point manually, make sure that you entered the correct SSID.

### Incorrect password/Incorrect Wi-Fi security settings

- Check the access point security settings (📖149).

### IP address conflict

- Reset the IP address so that it does not conflict with another.

### Disconnected/Receiving failed/Sending failed

- You may be in an environment where Wi-Fi signals are obstructed.
- Avoid using the camera's Wi-Fi function around microwave ovens, Bluetooth devices, and other devices that operate on the 2.4 GHz band.
- Bring the camera closer to the other device you are trying to connect to (such as the access point), and make sure there are no objects between the devices.
- Check the connected device to make sure it is not experiencing errors.

### Sending failed

#### Memory card error

- If the same error message is displayed even when you have inserted a formatted memory card facing the correct way, contact a Canon Customer Support Help Desk.

### Receiving failed

#### Insufficient space on card

- There is not enough free space on the memory card in the target camera to receive images. Erase images to create space on the memory card, or insert a memory card with sufficient space.

### Receiving failed

#### Memory card locked

- The write-protect switch of the memory card in the camera to receive the images is set to the locked position. Slide the write-protect switch to the unlocked position.

### Receiving failed

#### Naming error!

- When the highest folder number (999), and the highest image number (9999) have been reached on the receiving camera, images cannot be received.

### Insufficient space on server

- Delete unnecessary images uploaded to CANON iMAGE GATEWAY to create space.
- Save the images sent via Image Sync (📖162) to your computer.

### Check network settings

- Check to make sure your computer can connect to the Internet with the current network settings.

Before Use

Basic Guide

Advanced Guide

Camera Basics

Auto Mode /  
Hybrid Auto Mode

Other Shooting Modes

P Mode

Tv, Av, M, and C Mode

Playback Mode

Wi-Fi Functions

Setting Menu

Accessories

Appendix

Index





# On-Screen Information

## Shooting (Information Display)

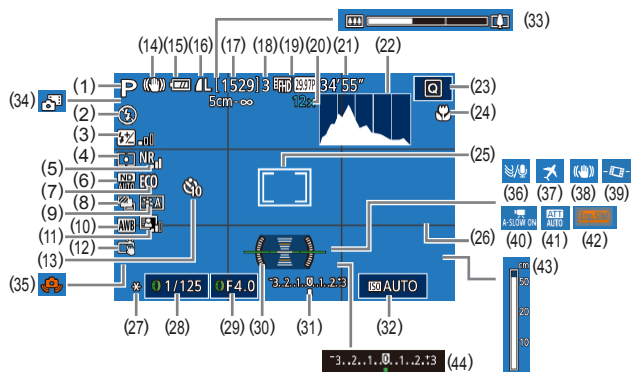

- (1) Shooting mode (200), Scene icon (38)
- (2) Flash mode (95)
- (3) Flash exposure compensation / Flash output level (96, 103)
- (4) Metering method (79)
- (5) High ISO speed NR (80)
- (6) ND Filter (81)
- (7) Eco mode (171)
- (8) Drive Mode (44), AEB shooting (81), Focus bracketing (88)
- (9) Picture Style (84)
- (10) White balance (82)
- (11) Auto Lighting Optimizer (81)
- (12) Touch Shutter (44)
- (13) Self-timer (42)
- (14) IS mode icon (40)
- (15) Battery level (197)
- (16) Still image compression (97), Recording pixel setting (97)
- (17) Recordable shots (220)
- (18) Maximum continuous shots
- (19) Movie quality (50)
- (20) Zoom magnification (41), Digital tele-converter (89)

- (21) Remaining time (220)
- (22) Histogram (113)
- (23) Quick Set menu (29)
- (24) Focus range (87, 87), AF lock (94)
- (25) AF frame (89), Spot AE point frame (79)
- (26) Grid lines (106)
- (27) AE lock (78), FE lock (96)
- (28) Shutter speed (100, 101)
- (29) Aperture value (101)
- (30) Electronic level (51)
- (31) Exposure level (101)
- (32) ISO speed (80)
- (33) Zoom bar (34)
- (34) Hybrid Auto mode (36)
- (35) Camera shake warning (37)
- (36) Wind filter (73)
- (37) Time zone (172)
- (38) Image stabilization (52)
- (39) Auto Level (52)
- (40) Auto slow shutter (73)
- (41) Attenuator (74)
- (42) Expo. simulation (78)
- (43) MF indicator (87)
- (44) Exposure compensation (78)

## Battery Level

An on-screen icon or message indicates the battery charge level.

Display	Details
	Sufficient charge
	Slightly depleted, but sufficient
	Nearly depleted. Charge the battery pack soon.
[Charge the battery]	Depleted. Charge the battery pack immediately.

Before Use

Basic Guide

Advanced Guide

Camera Basics

Auto Mode / Hybrid Auto Mode

Other Shooting Modes

P Mode

Tv, Av, M, and C Mode

Playback Mode

Wi-Fi Functions

Setting Menu

Accessories

Appendix

Index



## Playback (Detailed Information Display)

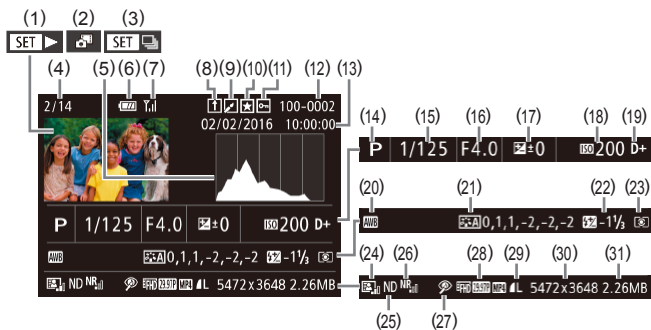

- |  |  |
|--|--|
| (1) Movies (📖34, 📖110)                             | (16) Aperture value (📖101, 📖101)   |
| (2) Digest movies (📖114)                           | (17) Exposure compensation level (📖78)                                   |
| (3) Group playback (📖117)                          | (18) ISO speed (📖80)   |
| (4) Current image no. / Total no. of images        | (19) Highlight tone priority (📖82)                                       |
| (5) Histogram (📖113)                               | (20) White balance (📖82)   |
| (6) Battery level (📖197)                           | (21) White balance correction (📖83), Picture Style setting details (📖84) |
| (7) Wi-Fi signal strength (📖161)                   | (22) Flash (📖95), Flash exposure compensation (📖96)                      |
| (8) Image Sync (📖162)                              | (23) Metering method (📖79)   |
| (9) Image editing (📖128), Movie compression (📖135) | (24) Auto Lighting Optimizer (📖81)                                       |
| (10) Favorites (📖126)                              | (25) ND filter (📖81), Short clip playback effect (📖74)                   |
| (11) Protection (📖121)                             | (26) High ISO speed NR (📖80)   |
| (12) Folder number - File number (📖168)            | (27) Focus range (📖87, 📖87), Red-eye correction (📖131)                   |
| (13) Shooting date/time (📖20)                      |  |
| (14) Shooting mode (📖200)                          |  |
| (15) Shutter speed (📖100, 📖101)                    |  |

- |  |   |
|--|---|
| (28) Image quality / Frame rate (movies) (📖50), Group playback (📖117)  | (30) Still images: Recording pixel setting (📖220)<br>Movies: Playback time (📖220) |
| (29) Compression (image quality) (📖97) / Recording pixels (📖50), Digest movies (📖36), RAW (📖98), MP4 (movies), Albums (📖136) | (31) File size  |



- Some information may not be displayed when viewing images on a TV (📖179).

Before Use

Basic Guide

Advanced Guide

Camera Basics

Auto Mode / Hybrid Auto Mode

Other Shooting Modes

P Mode

Tv, Av, M, and C Mode

Playback Mode

Wi-Fi Functions

Setting Menu

Accessories











Appendix

Index



## Summary of Movie Control Panel

The following operations are available on the movie control panel, accessed as described in “Viewing” (110).

	Touch to display the volume panel, and then touch [▲][▼] to adjust the volume. At a volume of 0, [🔇] is displayed.
	Play
	Slow Motion (To adjust the playback speed, press the [◀][▶] buttons or turn the [🌀] dial. No sound is played.)
	Skip Backward* or Previous Clip (135) (To continue skipping backward, keep holding down the [⏮] button.)
	Previous Frame (For fast-rewind, keep holding down the [⏮] button.)
	Next Frame (For fast-forward, keep holding down the [⏭] button.)
	Skip Forward* or Next Clip (135) (To continue skipping forward, keep holding down the [⏭] button.)
	Erase Clip (displayed when a digest movie is selected, 135)
	Edit (134)
	Shown when the camera is connected to a PictBridge-compatible printer (184).

\* Displays the frame approx. 4 sec. before or after the current frame.



- During movie playback, you can skip back or forward (or to the previous or next clip) by pressing the [◀][▶] buttons.

Before Use

Basic Guide

Advanced Guide

Camera Basics

Auto Mode /  
Hybrid Auto Mode

Other Shooting Modes

P Mode

Tv, Av, M, and C Mode

Playback Mode

Wi-Fi Functions

Setting Menu

Accessories

Appendix

Index





Function		Shooting Mode																												
		C	M	Av	Tv	P		AUTO																						
Av/Tv Settings (, )	Aperture Value	*1	O	O	-	-	-	-	-	-	-	-	-	-	-	-	-	-	-	-	-	-	-	-	-	-	-	-	-	
	Shutter Speed	*1	O	-	O	-	-	-	-	-	-	-	-	-	-	-	-	-	-	-	-	-	-	-	-	-	-	-	-	
	BULB	*1	O	-	-	-	-	-	-	-	-	-	-	-	-	-	-	-	-	-	-	-	-	-	-	-	-	-	-	
Program Shift ()		*1	*3	*3	*3	O	-	-	-	-	-	-	-	-	-	-	-	-	-	-	-	-	-	-	-	-	-	-	-	
AE Lock/FE Lock in Standby*4 (, )		*1	O	O	O	O	-	-	-	-	-	-	-	-	-	-	-	-	-	-	-	-	-	-	-	O	O	O	-	O
AE Lock (during recording), Exposure Compensation (, )		*1	O	O	O	O	-	-	-	O	O	O	O	O	-	O	O	O	O	O	O	O	O	O	O	O	O	O	-	O
AF Lock (when assigned to the Ring function selector) ()		*1	O	O	O	O	-	-	-	O	O	O	O	O	-	O	O	O	O	O	O	O	O	O	O	O	O	-	O	
AF Lock (when assigned to the movie button) ()		*1	O	O	O	O	-	-	-	O	O	O	O	O	-	O	O	O	O	O	O	O	O	O	O	O	-	-	-	
AF Lock by touch during recording ()		*1	O	O	O	O	-	-	-	O	O	-	-	-	O	O	-	O	O	-	-	-	-	O	O	-	O	-	O	
Optical Zoom		*1	O	O	O	O	O	O	O	O	O	-	-	-	O	O	O	O	O	O	O	O	O	O	O	O	O	O	O	O
Focus Range (, )		*1	O	O	O	O	O	O	O	O	O	O	O	O	O	O	O	O	O	O	O	O	O	O	O	O	O	O	O	O
		*1	O	O	O	O	-	-	O	O	-	-	-	O	O	O	O	O	O	O	O	O	O	O	O	-	-	O	O	
	/	-	-	-	-	-	-	-	-	-	-	-	-	-	-	-	-	-	-	-	-	-	-	-	O	-	-	-	-	
	MF	*1	O	O	O	O	-	-	-	O	O	-	O	O	O	O	O	O	O	O	O	O	O	O	O	O	-	O	O	O

O Available or set automatically. - Not available.

Before Use

Basic Guide

Advanced Guide

Camera Basics

Auto Mode /  
Hybrid Auto Mode

Other Shooting Modes

P Mode

Tv, Av, M, and C Mode

Playback Mode

Wi-Fi Functions

Setting Menu

Accessories

Appendix

Index



Function	Shooting Mode						Camera																Video								
	C	M	Av	Tv	P	AUTO	1	2	3	4	5	6	7	8	9	10	11	12	13	14	15	16	17	18	19	20	21	22	23	24	
Manual Focus Switching When Recording Movies (72)	*1	○	○	○	○	-	-	-	○	○	-	○	○	-	○	○	○	○	○	○	-	○	○	○	○	-	○	○	○	-	○
Move the AF Frame (90)	Center	*1	○	○	○	○	-	-	-	○	○	○	○	○	○	○	○	○	○	○	-	○	○	○	-	○	○	○	○	○	○
	Periphery	*1	○	○	○	○	-	-	-	○	○	○	*5	*5	*5	○	○	-	○	○	-	-	-	-	○	○	-	○	○	○	-
Touch AF (93)	*1	○	○	○	○	○	○	○	○	○	○	*5	*5	*5	○	○	-	○	○	-	-	-	-	○	○	-	○	○	○	-	
Face Select (93)	*1	○	○	○	○	○	○	○	○	○	○	-	-	-	○	○	-	○	○	-	○	○	○	○	-	-	○	○	○	-	
Touch Shutter (44)	*1	○	○	○	○	○	○	○	○	○	○	-	-	-	○	○	*6	○	○	-	○	○	○	○	○	*6	-	-	-	-	
Change Shooting Information Display (29)	*1	○	○	○	○	○	○	○	○	○	○	○	○	○	○	○	○	○	○	○	-	○	○	○	○	○	○	○	○	○	-

\*1 Options vary depending on the assigned shooting mode.

\*2 Not available, but switches to [1/2] in some cases.

\*3 To maintain the optimum exposure, ISO speed in addition to the aperture value or shutter speed may be automatically changed.

\*4 FE lock not available in [3] flash mode.

\*5 Only when [MF] is selected.

\*6 Only available for shooting. Subject designation not available.

○ Available or set automatically. - Not available.

Before Use

Basic Guide

Advanced Guide

Camera Basics

Auto Mode /  
Hybrid Auto Mode

Other Shooting Modes

P Mode

Tv, Av, M, and C Mode

Playback Mode

Wi-Fi Functions

Setting Menu

Accessories

Appendix

Index



















Function		Shooting Mode		CAMERA																VIDEO																																																																																																																																																																																																																																																																																																																																																																																																																																																																																																																																																																																																																																																																																																																																																																																																																																																																																																																																																																																																																																																																																																																																																																																																																																																																																																																																																																																																																																																																																																																													
				C	M	Av	Tv	P	AUTO	1	2	3	4	5	6	7	8	9	10	11	12	13	14	15	16	17	18	19	20	21	22	23	24	25	26	27	28	29	30	31	32	33	34	35	36	37	38	39	40	41	42	43	44	45	46	47	48	49	50	51	52	53	54	55	56	57	58	59	60	61	62	63	64	65	66	67	68	69	70	71	72	73	74	75	76	77	78	79	80	81	82	83	84	85	86	87	88	89	90	91	92	93	94	95	96	97	98	99	100	101	102	103	104	105	106	107	108	109	110	111	112	113	114	115	116	117	118	119	120	121	122	123	124	125	126	127	128	129	130	131	132	133	134	135	136	137	138	139	140	141	142	143	144	145	146	147	148	149	150	151	152	153	154	155	156	157	158	159	160	161	162	163	164	165	166	167	168	169	170	171	172	173	174	175	176	177	178	179	180	181	182	183	184	185	186	187	188	189	190	191	192	193	194	195	196	197	198	199	200	201	202	203	204	205	206	207	208	209	210	211	212	213	214	215	216	217	218	219	220	221	222	223	224	225	226	227	228	229	230	231	232	233	234	235	236	237	238	239	240	241	242	243	244	245	246	247	248	249	250	251	252	253	254	255	256	257	258	259	260	261	262	263	264	265	266	267	268	269	270	271	272	273	274	275	276	277	278	279	280	281	282	283	284	285	286	287	288	289	290	291	292	293	294	295	296	297	298	299	300	301	302	303	304	305	306	307	308	309	310	311	312	313	314	315	316	317	318	319	320	321	322	323	324	325	326	327	328	329	330	331	332	333	334	335	336	337	338	339	340	341	342	343	344	345	346	347	348	349	350	351	352	353	354	355	356	357	358	359	360	361	362	363	364	365	366	367	368	369	370	371	372	373	374	375	376	377	378	379	380	381	382	383	384	385	386	387	388	389	390	391	392	393	394	395	396	397	398	399	400	401	402	403	404	405	406	407	408	409	410	411	412	413	414	415	416	417	418	419	420	421	422	423	424	425	426	427	428	429	430	431	432	433	434	435	436	437	438	439	440	441	442	443	444	445	446	447	448	449	450	451	452	453	454	455	456	457	458	459	460	461	462	463	464	465	466	467	468	469	470	471	472	473	474	475	476	477	478	479	480	481	482	483	484	485	486	487	488	489	490	491	492	493	494	495	496	497	498	499	500	501	502	503	504	505	506	507	508	509	510	511	512	513	514	515	516	517	518	519	520	521	522	523	524	525	526	527	528	529	530	531	532	533	534	535	536	537	538	539	540	541	542	543	544	545	546	547	548	549	550	551	552	553	554	555	556	557	558	559	560	561	562	563	564	565	566	567	568	569	570	571	572	573	574	575	576	577	578	579	580	581	582	583	584	585	586	587	588	589	590	591	592	593	594	595	596	597	598	599	600	601	602	603	604	605	606	607	608	609	610	611	612	613	614	615	616	617	618	619	620	621	622	623	624	625	626	627	628	629	630	631	632	633	634	635	636	637	638	639	640	641	642	643	644	645	646	647	648	649	650	651	652	653	654	655	656	657	658	659	660	661	662	663	664	665	666	667	668	669	670	671	672	673	674	675	676	677	678	679	680	681	682	683	684	685	686	687	688	689	690	691	692	693	694	695	696	697	698	699	700	701	702	703	704	705	706	707	708	709	710	711	712	713	714	715	716	717	718	719	720	721	722	723	724	725	726	727	728	729	730	731	732	733	734	735	736	737	738	739	740	741	742	743	744	745	746	747	748	749	750	751	752	753	754	755	756	757	758	759	760	761	762	763	764	765	766	767	768	769	770	771	772	773	774	775	776	777	778	779	780	781	782	783	784	785	786	787	788	789	790	791	792	793	794	795	796	797	798	799	800	801	802	803	804	805	806	807	808	809	810	811	812	813	814	815	816	817	818	819	820	821	822	823	824	825	826	827	828	829	830	831	832	833	834	835	836	837	838	839	840	841	842	843	844	845	846	847	848	849	850	851	852	853	854	855	856	857	858	859	860	861	862	863	864	865	866	867	868	869	870	871	872	873	874	875	876	877	878	879	880	881	882	883	884	885	886	887	888	889	890	891	892	893	894	895	896	897	898	899	900	901	902	903	904	905	906	907	908	909	910	911	912	913	914	915	916	917	918	919	920	921	922	923	924	925	926	927	928	929	930	931	932	933	934	935	936	937	938	939	940	941	942	943	944	945	946	947	948	949	950	951	952	953	954	955	956	957	958	959	960	961	962	963	964	965	966	967	968	969	970	971	972	973	974	975	976	977	978	979	980	981	982	983	984	985	986	987	988	989	990	991	992	993	994	995	996	997	998	999	1000	1001	1002	1003	1004	1005	1006	1007	1008	1009	1010	1011	1012	1013	1014	1015	1016	1017	1018	1019	1020	1021	1022	1023	1024	1025	1026	1027	1028	1029	1030	1031	1032	1033	1034	1035	1036	1037	1038	1039	1040	1041	1042	1043	1044	1045	1046	1047	1048	1049	1050	1051	1052	1053	1054	1055	1056	1057	1058	1059	1060	1061	1062	1063	1064	1065	1066	1067	1068	1069	1070	1071	1072	1073	1074	1075	1076	1077	1078	1079	1080	1081	1082	1083	1084	1085	1086	1087	1088	1089	1090	1091	1092	1093	1094	1095	1096	1097	1098	1099	1100	1101	1102	1103	1104	1105	1106	1107	1108	1109	1110	1111	1112	1113	1114	1115	1116	1117	1118	1119	1120	1121	1122	1123	1124	1125	1126	1127	1128	1129	1130	1131	1132	1133	1134	1135	1136	1137	1138	1139	1140	1141	1142	1143	1144	1145	1146	1147	1148	1149	1150	1151	1152	1153	1154	1155	1156	1157	1158	1159	1160	1161	1162	1163	1164	1165	1166	1167	1168	1169	1170	1171	1172	1173	1174	1175	1176	1177	1178	1179	1180	1181	1182	1183	1184	1185	1186	1187	1188	1189	1190	1191	1192	1193	1194	1195	1196	1197	1198	1199	1200	1201	1202	1203	1204	1205	1206	1207	1208	1209	1210	1211	1212	1213	1214	1215	1216	1217	1218	1219	1220	1221	1222	1223	1224	1225	1226	1227	1228	1229	1230	1231	1232	1233	1234	1235	1236	1237	1238	1239	1240	1241	1242	1243	1244	1245	1246	1247	1248	1249	1250	1251	1252	1253	1254	1255	1256	1257	1258	1259	1260	1261	1262	1263	1264	1265	1266	1267	1268	1269	1270	1271	1272	1273	1274	1275	1276	1277	1278	1279	1280	1281	1282	1283	1284	1285	1286	1287	1288	1289	1290	1291	1292	1293	1294	1295	1296	1297	1298	1299	1300	1301	1302	1303	1304	1305	1306	1307	1308	1309	1310	1311	1312	1313	1314	1315	1316	1317	1318	1319	1320	1321	1322	1323	1324	1325	1326	1327	1328	1329	1330	1331	1332	1333	1334	1335	1336	1337	1338	1339	1340	1341	1342	1343	1344	1345	1346	1347	1348	1349	1350	1351	1352	1353	1354	1355	1356	1357	1358	1359	1360	1361	1362	1363	1364	1365	1366	1367	1368	1369	1370	1371	1372	1373	1374	1375	1376	1377	1378	1379	1380	1381	1382	1383	1384	1385	1386	1387	1388	1389	1390	1391	1392	1393	1394	1395	1396	1397	1398	1399	1400	1401	1402	1403	1404	1405	1406	1407	1408	1409	1410	1411	1412	1413	1414	1415	1416	1417	1418	1419	1420	1421	1422	1423	1424	1425	1426	1427	1428	1429	1430	1431	1432	1433	1434	1435	1436	1437	1438	1439	1440	1441	1442	1443	1444	1445	1446	1447	1448	1449	1450	1451	1452	1453	1454	1455	1456	1457	1458	1459	1460	1461	1462	1463	1464	1465	1466	1467	1468	1469	1470	1471	1472	1473	1474	1475	1476	1477	1478	1479	1480



Function		Shooting Mode																										
		C	M	Av	Tv	P	AUTO	Self-Timer	Interval	Time-Lapse	Movie	Star	Time-Lapse	Movie	Star	Time-Lapse	Movie	Star	Time-Lapse	Movie	Star	Time-Lapse	Movie	Star	Time-Lapse	Movie		
Self-Timer (📖42)		See "Quick Set Menu" (📖203).																										
 Star Time-Lapse Movie Setting (📖68)	Save	Enable/ Disable	-	-	-	-	-	-	-	-	-	-	-	-	-	-	-	-	-	-	-	-	-	-	-	-	-	
	Effect* <sup>3</sup>		-	-	-	-	-	-	-	-	-	-	-	-	-	-	-	-	-	-	-	-	-	-	-	-	-	
	Shot Interval	15 sec./30 sec./ 1 min.* <sup>4</sup>	-	-	-	-	-	-	-	-	-	-	-	-	-	-	-	-	-	-	-	-	-	-	-	-	-	
	Frame Rate	NTSC:  / / PAL:  / 	-	-	-	-	-	-	-	-	-	-	-	-	-	-	-	-	-	-	-	-	-	-	-	-	-	-
	Shooting Time	60 min./90 min./ 120 min./ Unlimited	-	-	-	-	-	-	-	-	-	-	-	-	-	-	-	-	-	-	-	-	-	-	-	-	-	-
	Auto exposure	Lock to 1st shot/ For each shot	-	-	-	-	-	-	-	-	-	-	-	-	-	-	-	-	-	-	-	-	-	-	-	-	-	-

O Available or set automatically. – Not available.

- Before Use
- Basic Guide
- Advanced Guide
- Camera Basics
- Auto Mode / Hybrid Auto Mode
- Other Shooting Modes
- P Mode
- Tv, Av, M, and C Mode
- Playback Mode
- Wi-Fi Functions
- Setting Menu
- Accessories
- Appendix
- Index









## Set Up Tab

Tab	Item	Reference Page
☛1	Create Folder	📖 168
	File Numbering	📖 168
	Format	📖 169
	Video system	📖 170
	Electronic Level	📖 51
	Start-up Image	📖 170
	Eco Mode	📖 171
☛2	Power Saving	📖 27
	Disp. Brightness	📖 171
	Night Display	📖 172
	Time Zone	📖 172
	Date/Time	📖 172
	Lens Retraction	📖 173

Tab	Item	Reference Page
☛3	Language 	📖 173
	Mute	📖 173
	Volume	📖 173
	Sound Options	📖 174
	Hints & Tips	📖 174
	Mode icon size/info	📖 174
☛4	Touch Operation	📖 174
	Units	📖 175
	Wireless settings	📖 141
	Certification Logo Display	📖 175
	Copyright Info	📖 175
	Reset All	📖 176

## My Menu Tab

Tab	Item	Reference Page
★1	My Menu settings	📖 109

Before Use

Basic Guide

Advanced Guide

Camera Basics

Auto Mode /  
Hybrid Auto Mode

Other Shooting Modes

P Mode

Tv, Av, M, and C Mode

Playback Mode

Wi-Fi Functions

Setting Menu

Accessories

Appendix

Index



## Playback Tab

Tab	Item	Reference Page
▶ 1	Protect	📖 121
	Rotate	📖 125
	Erase	📖 123
	Favorites	📖 126
	Slideshow	📖 120
▶ 2	Album Playback	📖 136
	List/Play Digest Movies	📖 114
	Short Clip Mix	📖 139
	Image Search	📖 115
	Creative filters	📖 130
▶ 3	Resize	📖 128
	Cropping	📖 129
	Red-Eye Correction	📖 131
	Face ID Info	📖 114
	RAW img processing	📖 132
▶ 4	Print settings	📖 188
	Photobook Set-up	📖 190

Tab	Item	Reference Page
▶ 5	Transition Effect	📖 110
	Index Effect	📖 115
	Scroll Display	📖 110
	Group Images	📖 117
	Auto Rotate	📖 126
	Resume	📖 110
▶ 6	Image jump with 🗣️	📖 117
	Set Touch Actions	📖 127
	Playback information display	📖 112

Before Use

Basic Guide

Advanced Guide

Camera Basics

Auto Mode /  
Hybrid Auto Mode

Other Shooting Modes

P Mode

Tv, Av, M, and C Mode

Playback Mode

Wi-Fi Functions

Setting Menu

Accessories

Appendix

Index



## Handling Precautions

- The camera is a high-precision electronic device. Avoid dropping it or subjecting it to strong impact.
- Never bring the camera near magnets, motors, or other devices that generate strong electromagnetic fields. The electromagnetic wave may cause malfunction or erase image data.
- If water droplets or dirt adheres to the camera or screen, wipe with a dry soft cloth, such as an eyeglass cloth. Do not rub hard or apply force.
- Never use cleaners containing organic solvents to clean the camera or screen.
- Use a blower brush to remove dust from the lens. If cleaning is difficult, contact a Canon Customer Support Help Desk.
- To prevent condensation from forming on the camera after sudden changes in temperature (when the camera is transferred from cold to warm environments), put the camera in an airtight, resealable plastic bag and let it gradually adjust to the temperature before removing it from the bag.
- If condensation does form on the camera, stop using it immediately. Continuing to use the camera in this state may damage it. Remove the battery pack and memory card, and wait until the moisture has evaporated before resuming use.
- Store unused battery packs in a plastic bag or other container. To maintain battery performance if you will not use the battery pack for some time, about once a year charge it and then use the camera until it runs out of power before storing the battery pack.

## Specifications

### Camera

#### Image Sensor

##### Camera Effective Pixels

(Image processing may cause a decrease

in the number of pixels.) ..... Approx. 20.1 megapixels

Total Pixels..... Approx. 20.9 megapixels

Image Size..... 1.0 type

#### Lens

##### Focal Length

(35mm film equivalent) ..... 8.8 – 36.8 mm (24 – 100 mm)

Zoom Magnification ..... 4.2x

Step Zoom ..... 24, 28, 35, 50, 85, 100 mm

#### Digital zoom

Magnification..... Approx. 4x

##### Max. Magnification

(digital x optical zoom)..... Approx. 17x

##### Focal Length

(max. telephoto, 35mm film equivalent) .... Equivalent to approx. 400 mm

#### Screen (Monitor)

Type ..... TFT color liquid crystal

Screen Size ..... 3.0 type

Effective Pixels ..... Approx. 1,040,000 dots

#### Continuous Shooting (CIPA compliant)

##### Speed

(Varies depending on the subject,  
zoom position, and other shooting factors,  
as well as memory card brands.)

ONE SHOT H: Approx. 8.0 shots/  
sec. (max. 30 shots)

ONE SHOT L: Approx. 4.0 shots/  
sec.

SERVO H: Approx. 5.4 shots/sec.  
(max. 46 shots)

SERVO L: Approx. 4.0 shots/sec.

Before Use

Basic Guide

Advanced Guide

Camera Basics

Auto Mode /  
Hybrid Auto Mode

Other Shooting Modes

P Mode

Tv, Av, M, and C Mode

Playback Mode

Wi-Fi Functions

Setting Menu

Accessories

Appendix

Index



<b>Built-In Flash</b>	
Flash Range (Wide angle end).....	50 cm – 7.0 m (1.6 – 23 ft.)
Flash Range (Telephoto end) .....	40 cm – 4.0 m (1.3 – 13 ft.)
<b>Shutter Speed</b>	
Auto Mode (automatic settings).....	1 – 1/2000 sec.
Range in all shooting modes	
Max. ....	30 sec.
Min. ....	1/2000 sec.
Speed (unit: sec.).....	Tv, M modes
	(BULB) 30, 25, 20, 15, 13, 10,
	8, 6, 5, 4, 3.2, 2.5, 2, 1.6, 1.3, 1,
	0.8, 0.6, 0.5, 0.4, 0.3, 1/4, 1/5,
	1/6, 1/8, 1/10, 1/13, 1/15, 1/20,
	1/25, 1/30, 1/40, 1/50, 1/60, 1/80,
	1/100, 1/125, 1/160, 1/200, 1/250,
	1/320, 1/400, 1/500, 1/640, 1/800,
	1/1000, 1/1250, 1/1600, 1/2000
	Speeds in ( ) for M mode only
	Cannot be set 1/6 or slower in
	Manual movie mode
<b>Aperture</b>	
F number .....	1.8 – 11 (W)
	2.8 – 11 (T)
<b>AF</b>	
AF method .....	Face+Tracking AF (number of AF
	frames: max. 31), Single-point AF
File Format.....	Design rule for Camera File
	system (DCF) compliant; DPOF
	(version 1.1) compatible

<b>Data Type (Still Images)</b>	
Image File Format.....	Exif 2.3 (DCF 2.0)
Image Types .....	JPEG, RAW (Canon original: 14-bit, CR2)

<b>Data Type (Movies)</b>	
Recording Format.....	MP4
Video.....	MPEG-4 AVC/H.264
Audio.....	MPEG-4 AAC LC (stereo)

<b>Power Source</b>	
Battery Pack .....	NB-13L

<b>Interface</b>	
Wired .....	Hi-Speed USB (Micro), HDMI (Type D)
Wireless.....	Wi-Fi
	Specifications: IEEE 802.11b/g/n
	Frequency: 2.4 GHz
	Channels: 1 – 11
	Security: WEP, WPA-PSK (AES/TKIP), WPA2-PSK (AES/TKIP)
	NFC

<b>Operating Environment</b>	
Temperature.....	0 – 40 °C (32 – 104 °F)

<b>Dimensions (CIPA compliant)</b>	
(W x H x D) .....	105.5 x 60.9 x 42.2 mm (4.15 x 2.40 x 1.66 in.)

<b>Weight (CIPA compliant)</b>	
Including Battery Pack, Memory Card .....	Approx. 319 g (approx. 11.3 oz.)
Camera Body Only .....	Approx. 294 g (approx. 10.4 oz.)

Before Use

Basic Guide

Advanced Guide

Camera Basics

Auto Mode /  
Hybrid Auto Mode

Other Shooting Modes

P Mode

Tv, Av, M, and C Mode

Playback Mode

Wi-Fi Functions

Setting Menu

Accessories

Appendix

Index









## Number of Shots/Recording Time, Playback Time

Number of Shots (CIPA compliant)	Approx. 265 shots
Number of Shots in Eco Mode	Approx. 355 shots
Movie Recording Time (CIPA compliant)* <sup>1</sup>	Approx. 55 min.
Movie Recording Time (Continuous Shooting)* <sup>2</sup>	Approx. 1 hr. 30 min
Playback Time* <sup>3</sup>	Approx. 5 hr.

- \*1 Total time when shooting repeatedly under the following conditions:  
 - In **[AUTO]** mode, with all other settings set to defaults  
 - With recording, stopping, zooming, and turning the camera on and off
- \*2 Total time when shooting repeatedly under the following conditions:  
 - In **[AUTO]** mode, with all other settings set to defaults  
 - Without zooming or other operations  
 - Automatically stop/resume after the time or capacity per recording is reached
- \*3 Time when playing back a slideshow of still images.

## Shooting Range

Shooting Mode	Focus Range	Maximum Wide Angle (  )	Maximum Telephoto (  )
<b>AUTO*</b>	—	5 cm – ∞ (2.0 in. – infinity)	40 cm – ∞ (1.3 ft. – infinity)
Other modes		5 cm – ∞ (2.0 in. – infinity)	40 cm – ∞ (1.3 ft. – infinity)
		5 cm – 50 cm (2.0 in. – 1.6 ft.)	—
		5 cm – 50 cm (2.0 in. – 1.6 ft.)	—
		1.5 m – 20 m (5.0 – 65.6 ft.)	1.5 m – 20 m (5.0 – 65.6 ft.)

\* Same with manual focus enabled.

Before Use

Basic Guide

Advanced Guide

Camera Basics

Auto Mode /  
Hybrid Auto Mode

Other Shooting Modes

P Mode

Tv, Av, M, and C Mode

Playback Mode

Wi-Fi Functions

Setting Menu

Accessories

Appendix

Index



## Number of Shots per Memory Card

The number of shots at an aspect ratio (📖49) of 3:2 per memory card is as follows. Note that the number of shots available varies by aspect ratio.

Number of shots per 16 GB memory card (approx. shots)

L	📐L	1786
	📐L	2999
M	📐M	3982
	📐M	6656
S1	📐S1	6073
	📐S1	11043
S2		7712
RAW		525

- The values in the table are based on Canon measurement conditions and may change depending on the subject, memory card and camera settings.

## Recording Time per Memory Card

Size	Frame Rate/ Video System	Recording Time per 16 GB Memory Card (Approx.)	Recording Time for Individual Movies (Approx.)
📐FHD (1920 x 1080)	📐FHD 59.94P (NTSC) 📐FHD 50.00P (PAL)	59 min. 30 sec.	29 min. 59 sec.
	📐FHD 29.97P, 📐FHD 23.98P *(NTSC) 📐FHD 25.00P (PAL)	1 hour 26 min. 5 sec.	29 min. 59 sec.
📐HD (1280 x 720)	📐HD 29.97P (NTSC) 📐HD 25.00P (PAL)	4 hours 5 min. 15 sec.	29 min. 59 sec.
📐VGA (640 x 480)	📐VGA 29.97P (NTSC) 📐VGA 25.00P (PAL)	10 hours 22 min. 35 sec.	1 hour

\* Actual frame rate: 23.976 fps.

- The values in the table are based on Canon measurement conditions and may change depending on the subject, memory card and camera settings.
- Recording times for individual movies are based on memory cards rated at an SD speed class of 10. Recording may stop when cards rated at lower speed classes are used. Recording will also stop automatically when the file size reaches 4 GB, or when the card becomes full.

Before Use

Basic Guide

Advanced Guide

Camera Basics

Auto Mode /  
Hybrid Auto Mode

Other Shooting Modes

P Mode

Tv, Av, M, and C Mode

Playback Mode

Wi-Fi Functions

Setting Menu

Accessories

Appendix

Index





## Battery Pack NB-13L

---

Type:	Rechargeable lithium-ion battery
Nominal Voltage:	3.6 V DC
Nominal Capacity:	1250 mAh
Charging Cycles:	Approx. 300 times
Operating Temperatures:	0 – 40 °C (32 – 104 °F)

## Battery Charger CB-2LH/CB-2LHE

---

Rated Input:	100 – 240 V AC (50/60 Hz) 0.09 A (100 V) – 0.06 A (240 V)
Rated Output:	4.2 V DC, 0.7 A
Charging Time:	Approx. 2 hr. 10 min. (when using NB-13L)
Operating Temperatures:	5 – 40 °C (41 – 104 °F)

## Compact Power Adapter CA-DC30/CA-DC30E

---

Rated Input:	100 – 240 V AC (50/60 Hz) 0.07 A (100 V) – 0.045 A (240 V)
Rated Output:	5.0 V DC, 0.55 A
Charging Time:	Approx. 5 hr.* (Charged with NB-13L inserted in the camera) * Charging time varies considerably depending on the remaining battery power.
Operating Temperatures:	5 – 40 °C (41 – 104 °F)

- Size, weight, and number of shots available are based on measurement guidelines of the Camera & Imaging Products Association (CIPA).
- Under some shooting conditions, the number of shots and recording time may be less than mentioned above.
- Number of shots/time with a fully charged battery pack.

Before Use

Basic Guide

Advanced Guide

Camera Basics

Auto Mode /  
Hybrid Auto Mode

Other Shooting Modes

P Mode

Tv, Av, M, and C Mode

Playback Mode

Wi-Fi Functions

Setting Menu

Accessories

Appendix

Index



# Index

## A

Accessories 178  
AEB shooting 81  
AE lock 78  
AF frames 89  
AF lock 94  
AF method 89  
Aspect ratio 49  
Auto lighting optimizer 81  
AUTO mode (shooting mode) 22, 34  
Av (shooting mode) 101

## B

Background defocus (shooting mode) 63  
Batteries → Date/time (date/time battery)  
Battery charger 2, 178  
Battery pack  
    Charging 18  
    Eco mode 171  
    Level 197  
    Power saving 27

## C

Camera  
    Reset all 176  
Camera access point mode 147  
Camera Connect 142  
CameraWindow 182  
CANON iMAGE GATEWAY 153  
Clock 33  
Color (white balance) 82  
Compression 97

Connecting via an access point 149  
Continuous shooting 39, 44  
Creative filters 130  
Cropping 129, 185  
C (shooting mode) 105  
Custom white balance 83

## D

Date/time  
    Changing 21  
    Date/time battery 21  
    Settings 20  
    World clock 172  
Defaults → Reset all  
Digital tele-converter 89  
Digital zoom 41  
Display language 22  
DPOF 187  
Dragging 17

## E

Eco mode 171  
Editing  
    Cropping 129  
    Red-eye correction 131  
    Resizing images 128  
Editing or erasing connection information 165  
Electronic level 51  
Erasing 123  
Erasing all 124  
Error messages 195  
Exposure  
    AE lock 78

Compensation 78  
FE lock 96

## F

Face ID 45  
Face select 93  
Favorites 126  
FE lock 96  
File numbering 168  
Fireworks (shooting mode) 56  
Fish-eye effect (shooting mode) 60  
Flash  
    Deactivating flash 95  
    Flash exposure compensation 96  
    On 95  
    Slow synchro 95  
Focus bracketing 88  
Focus check 119  
Focusing  
    AF frames 89  
    AF lock 94  
    MF peaking 88  
    Servo AF 91  
    Touch AF 93  
Focus lock 90  
Focus range  
    Macro 87  
    Manual focus 87  
    Quick 57  
    Underwater macro 57

## G

Geotagging images 164  
GPS information display 113  
Grainy B/W (shooting mode) 64  
Grid lines 106

## H

Handheld nightscene (shooting mode) 56  
HDMI cable 179  
High dynamic range (shooting mode) 60  
High ISO speed noise reduction 80  
Hybrid Auto (shooting mode) 36

## I

iFrame movies (movie mode) 76  
Image quality → Compression  
Images  
    Display period 54  
    Erasing 123  
    Playback → Viewing  
    Protecting 121  
Image stabilization 52, 99  
Image Sync 162  
Indicator 33, 53, 54  
ISO speed 80

## J

Jump display 117

## M

M (shooting mode) 101  
Macro (focus range) 87  
Magnified display 119  
Manual focus (focus range) 87  
Manual (movie mode) 103  
Memory cards 2  
    Recording time 220  
Menu  
    Basic operations 30  
    Table 200  
Metering method 79

Before Use

Basic Guide

Advanced Guide

Camera Basics

Auto Mode /  
Hybrid Auto Mode

Other Shooting Modes

P Mode

Tv, Av, M, and C Mode

Playback Mode

Wi-Fi Functions

Setting Menu

Accessories

Appendix

Index



Miniature effect (shooting mode) 62  
Movies

- Editing 134
- Image quality (recording pixels/  
frame rate) 50
- Recording time 220

## N

ND filter 81

## P

- P (shooting mode) 77
- Package contents 2
- Panning (shooting mode) 59
- Photobook set-up 190
- PictBridge 179, 184
- Playback → Viewing
- Portrait (shooting mode) 56
- Power 178 → Battery charger,  
→ Battery pack
- Power saving 27
- Printing 184 → Printing
- Program AE 77
- Protecting 121

## Q

- Quick (focus range) 57
- Quick Set menu  
Table 203

## R

- RAW 98
- RAW img processing 132
- Recording pixels (image size) 97
- Red-eye correction 131
- Remote shooting 164
- Reset all 176

Resizing images 128  
Rotating 125

## S

- Saving images to a computer 182
- Screen
  - Display language 22
  - Icons 197, 198
  - Menu → Quick Set menu, Menu
- SD/SDHC/SDXC memory cards
  - Memory cards
- Searching 115
- Self portrait (shooting mode) 58
- Self-timer 42
  - 2-second self-timer 43
  - Customizing the self-timer 43
- Sending images 158
- Sending images to another camera 158
- Sending images to a smartphone 142
- Sending images to Web services 153
- Servo AF 91
- Shooting
  - Shooting date/time → Date/time
  - Shooting information 106, 197
- Short clips (movie mode) 74
- Slideshow 120
- Soft focus (shooting mode) 64
- Software
  - Installation 147, 182
  - Saving images to a computer 182
- Sounds 173
- Standard (movie mode) 72
- Star (shooting mode) 65
  - Star nightscape (shooting mode) 66

Star time-lapse movie (shooting  
mode) 68

Star trails (shooting mode) 67

Story Highlights 136

Strap 2

## T

- Terminal 179, 184
- Time-lapse movie (shooting mode) 74
- Touch Actions 127
- Touch AF 93
- Touching 17
- Touch-screen panel 17
- Touch Shutter 44
- Toy camera effect (shooting mode) 63
- Traveling with the camera 172
- Troubleshooting 191
- TV display 179
- Tv (shooting mode) 100

## U

- Underwater macro (focus range) 57
- Underwater (shooting mode) 57

## V

- Viewing 24
  - Image search 115
  - Index display 115
  - Jump display 117
  - Magnified display 119
  - Single-image display 24
  - Slideshow 120
  - TV display 179

## W

- White balance (color) 82

Wi-Fi functions 141

Wi-Fi menu 144

Wind filter 73

World clock 172

Wrist strap → Strap

## Z

- Zoom 22, 35, 41

Before Use

Basic Guide

Advanced Guide

Camera Basics

Auto Mode /  
Hybrid Auto Mode

Other Shooting Modes

P Mode

Tv, Av, M, and C Mode

Playback Mode

Wi-Fi Functions

Setting Menu

Accessories

Appendix

Index



## Wi-Fi (Wireless LAN) Precautions

- Countries and Regions Permitting WLAN Use
  - Use of WLAN is restricted in some countries and regions, and illegal use may be punishable under national or local regulations. To avoid violating WLAN regulations, visit the Canon website to check where use is allowed.  
Note that Canon cannot be held liable for any problems arising from use in other countries and regions.
- Doing any of the following may incur legal penalties:
  - Altering or modifying the product
  - Removing the certification labels from the product
- According to foreign exchange and foreign trade law regulations, export permission (or service transaction permission) from the Japanese government is necessary to export strategic resources or services (including this product) outside Japan.
- Because this product includes American encryption software, it falls under U.S. Export Administration Regulations, and cannot be exported to or brought into a country under U.S. trade embargo.
- Be sure to make notes of the wireless LAN settings you use. The wireless LAN settings saved to this product may change or be erased due to incorrect operation of the product, the effects of radio waves or static electricity, or accident or malfunction. Be sure to make notes of wireless LAN settings as a precaution. Please note that Canon accepts no responsibility for direct or indirect damages or loss of earnings resulting from a degradation or disappearance of content.
- When transferring this product to another person, disposing of it, or sending it for repair, be sure to note the wireless LAN settings and reset the product to its default settings (erase settings) if necessary.
- Canon will not make compensation for damages resulting from loss or theft of the product.  
Canon accepts no responsibility for damages or loss resulting from unauthorized access or use of target devices registered on this product due to loss or theft of the product.

- Be sure to use the product as directed in this guide.  
Be sure to use the wireless LAN function of this product within the guidelines noted in this guide. Canon accepts no responsibility for damages or loss if the function and product are used in ways other than as described in this guide.
- Do not use the wireless LAN function of this product near medical equipment or other electronic equipment.  
Use of the wireless LAN function near medical equipment or other electronic equipment may affect operation of those devices.

## Radio Wave Interference Precautions

- This product may receive interference from other devices that emit radio waves. To avoid interference, be sure to use this product as far away as possible from such devices, or avoid using the devices at the same time as this product.

## Security Precautions

Because Wi-Fi uses radio waves to transmit signals, security precautions more stringent than when using a LAN cable are required. Keep the following points in mind when using Wi-Fi.

- Only use networks you are authorized to use.  
This product searches for Wi-Fi networks in the vicinity and displays the results on the screen. Networks you are not authorized to use (unknown networks) may also be displayed. However, attempting to connect to or using such networks could be regarded as unauthorized access. Be sure to use only networks you are authorized to use, and do not attempt to connect to other unknown networks.

Before Use

Basic Guide

Advanced Guide

Camera Basics

Auto Mode /  
Hybrid Auto Mode

Other Shooting Modes

P Mode

Tv, Av, M, and C Mode

Playback Mode

Wi-Fi Functions

Setting Menu

Accessories

Appendix

Index



If security settings have not been properly set, the following problems may occur.

- **Transmission monitoring**  
Third parties with malicious intent may monitor Wi-Fi transmissions and attempt to acquire the data you are sending.
- **Unauthorized network access**  
Third parties with malicious intent may gain unauthorized access to the network you are using to steal, modify, or destroy information. Additionally, you could fall victim to other types of unauthorized access such as impersonation (where someone assumes an identity to gain access to unauthorized information) or springboard attacks (where someone gains unauthorized access to your network as a springboard to cover their tracks when infiltrating other systems).

To prevent these types of problems from occurring, be sure to thoroughly secure your Wi-Fi network.

Only use this camera's Wi-Fi function with a proper understanding of Wi-Fi security, and balance risk and convenience when adjusting security settings.



The camera can print to PictBridge-compatible printers via Wi-Fi. PictBridge technical standards make it easy to connect digital cameras, printers, and other devices directly. Additionally, a new standard called DPS over IP enables PictBridge connections in network environments, and the camera is also compatible with this standard.

## Trademarks and Licensing

- Microsoft and Windows are trademarks or registered trademarks of Microsoft Corporation in the United States and/or other countries.
- Macintosh and Mac OS are trademarks of Apple Inc., registered in the U.S. and other countries.
- App Store, iPhone, and iPad are trademarks of Apple Inc.
- The SDXC logo is a trademark of SD-3C, LLC.
- HDMI, the HDMI logo and High-Definition Multimedia Interface are trademarks or registered trademarks of HDMI Licensing, LLC.
- The iFrame logo and the iFrame symbol are trademarks of Apple Inc.
- Wi-Fi®, Wi-Fi Alliance®, WPA™, WPA2™ and Wi-Fi Protected Setup™ are trademarks or registered trademarks of the Wi-Fi Alliance.
- The N-Mark is a trademark or registered trademark of NFC Forum, Inc. in the United States and in other countries.
- All other trademarks are the property of their respective owners.
- This device incorporates exFAT technology licensed from Microsoft.
- This product is licensed under AT&T patents for the MPEG-4 standard and may be used for encoding MPEG-4 compliant video and/or decoding MPEG-4 compliant video that was encoded only (1) for a personal and non-commercial purpose or (2) by a video provider licensed under the AT&T patents to provide MPEG-4 compliant video. No license is granted or implied for any other use for MPEG-4 standard.

## Disclaimer

- Unauthorized reproduction of this guide is prohibited.
- All measurements based on Canon testing standards.
- Information subject to change without notice, as are product specifications and appearance.
- Illustrations and screenshots in this guide may differ slightly from the actual equipment.
- The above items notwithstanding, Canon cannot be held liable for any loss arising from the use of this product.

Before Use

Basic Guide

Advanced Guide

Camera Basics

Auto Mode /  
Hybrid Auto Mode

Other Shooting Modes

P Mode

Tv, Av, M, and C Mode

Playback Mode

Wi-Fi Functions

Setting Menu

Accessories

Appendix

Index

