

# Canon

# *PowerShot* SX70 HS

## Advanced User Guide

Contents

Camera Basics

Shooting

Playback

Wireless Features

Function Settings

Accessories

Tips on Using the Camera

Index

ENGLISH

## Preliminary Notes and Legal Information

- Take and review some test shots initially to make sure the images were recorded correctly. Please note that Canon Inc., its subsidiaries and affiliates, and its distributors are not liable for any consequential damages arising from any malfunction of a camera or accessory, including memory cards, that result in the failure of an image to be recorded or to be recorded in a way that is machine readable.
- The user's unauthorized photographing or recording (video and/or sound) of people or copyrighted materials may invade the privacy of such people and/or may violate others' legal rights, including copyright and other intellectual property rights. Note that restrictions may apply even when such photographing or recording is intended solely for personal use.
- The camera warranty is valid only in the area of purchase. In case of camera problems while abroad, return to the area of purchase before contacting a Customer Support Help Desk.
- Although the screen is produced under extremely high-precision manufacturing conditions and more than 99.99% of the pixels meet design specifications, in rare cases some pixels may be defective or may appear as red or black dots. This does not indicate camera damage or affect recorded images.
- When the camera is used over an extended period, it may become warm. This does not indicate damage.

# Introduction

- To jump to the beginning of a chapter, click the chapter title along the right side of the top page.
- For basic page navigation, click the icons at the bottom of each page.
  - 🏠: Go to the top page
  - ↶: Return to the previous page
  - ⏪: Go back a page
  - ⏩: Go forward a page
- Instructions in this guide apply to the camera under default settings.
- Tabs such as **P** identify which modes are used in the shooting instructions. Some features are also available in other modes.
- For tips that make the camera easier to use, click the  icon.

## Text Conventions

- In this guide, icons are used to represent the corresponding camera buttons and dials on which they appear or which they resemble.
- The following camera controls are represented by icons.



- On-screen icons and text are indicated in brackets.
- Numbers in some figures and illustrations correspond to numbers in the steps.
-  xx: Pages with related information (in this example, “xx” represents a page number)
- For convenience, all supported memory cards are simply referred to as the “memory card”.

# Contents

Preliminary Notes and Legal Information .....	2
Introduction .....	3
Text Conventions .....	3
Common Camera Operations .....	15
Safety Instructions.....	18
<b>Camera Basics .....</b>	<b>21</b>
Getting Ready .....	22
Attaching the Strap .....	22
Charging the Battery Pack.....	23
Preparing a Memory Card .....	24
Inserting/Removing the Battery Pack and Memory Card .....	25
Setting the Date, Time, Time Zone, and Language .....	27
Holding the Camera .....	29
Trying the Camera Out.....	30
Shooting .....	30
Viewing .....	32
Part Names .....	33
Front .....	33
Back.....	34
Viewfinder .....	35
Adjusting the Screen Angle .....	36
Indicator Display.....	37
Setting a Shooting Mode.....	38
Configuring Camera Features.....	39
Quick Control Screen .....	39
Menu Screen .....	40
Features Available on the Quick Control Screen .....	42
Menu Settings .....	43



Shooting Mode Screen.....	45
Frames on the Shooting Screen .....	46
Shooting Display Options .....	47
Playback Display Options .....	48
Switching Histograms .....	49
On-Screen Keyboard .....	50
<b>Shooting.....</b>	<b>51</b>
Shooting with Camera-Determined Settings (Auto Mode/Hybrid Auto Mode).....	52
Shooting in Hybrid Auto Mode .....	54
Shooting Panoramas (Panorama Mode).....	55
Shooting Subjects in Motion (Sports Mode).....	56
Shooting Specific Scenes (Special Scene Mode).....	57
Shooting Yourself under Optimal Settings (Self Portrait Mode).....	60
Shooting with Image Effects (Creative Filters Mode).....	61
Shots Resembling Miniature Models (Miniature Effect).....	64
Recording a Variety of Movies (Movie Mode) .....	65
Recording Movies at Specific Shutter Speeds and Aperture Values (Movie Manual Exposure) .....	65
Shooting in Program AE (P Mode).....	67
Shooting at Specific Shutter Speeds (Tv Mode).....	68
Shooting at Specific Aperture Values (Av Mode) .....	69
Shooting at Specific Shutter Speeds and Aperture Values (M Mode).....	70
Zooming In Closer on Subjects (Digital Zoom) .....	71
Locking Image Brightness / Exposure (AE Lock).....	72
Easily Reacquiring Subjects after Manual Zooming (Framing Assist – Seek).....	73
Display Area Options.....	74

Auto Zooming in Response to Subject Movement (Auto Zoom) .....	75
Adjusting the Constant Face Display Size.....	76
Avoiding Lost Subjects after Zooming In (Framing Assist – Lock).....	77
Disabling Centered Subject Display .....	78
Shooting Close-Ups (Macro).....	79
Shooting in Manual Focus Mode.....	80
Easily Identifying the Focus Area (MF Peaking).....	81
Shooting with AF Lock.....	82
Changing Image Quality.....	83
Capturing in RAW Format.....	83
Changing the Aspect Ratio.....	84
Changing the Image Display Period after Shots .....	85
Changing the Flash Mode .....	86
Locking Brightness / Exposure in Flash Photography (FE Lock).....	87
Configuring Flash Settings .....	88
Adjusting Flash Exposure Compensation.....	88
Adjusting Flash Output .....	89
Changing the Flash Timing.....	90
Reducing Red-Eye .....	90
Configuring Safety FE .....	91
Continuous Shooting.....	92
Using the Self-Timer .....	93
Adding a Date Stamp.....	94
Adjusting Image Brightness (Exposure Compensation).....	95
Auto Exposure Bracketing (AEB Shooting) .....	96
Changing the ISO Speed .....	98
Adjusting ISO Auto Settings .....	98

Auto Correction of Brightness and Contrast (Auto Lighting Optimizer) .....	99
Changing the Metering Method.....	100
Setting the Metering Timer .....	101
Configuring Exposure Simulation.....	102
Capturing Natural Colors (White Balance).....	103
Custom White Balance .....	104
Customizing Colors (Style Settings).....	105
Shooting with Servo AF.....	106
Choosing the AF Method.....	107
Choosing Subjects to Focus On (Tracking AF).....	107
Moving the AF Point .....	109
Changing the Focus Setting.....	110
Configuring the AF-Assist Beam .....	111
Changing the IS Mode Settings .....	112
Correcting Severe Camera Shake.....	112
Using Auto Level .....	113
Using Digital Tele-Converter .....	114
Storing the Zoom or MF Position .....	115
Changing Movie Recording Size.....	116
Configuring Sound Recording Settings .....	117
Adjusting the Recording Volume .....	117
Wind Filter .....	118
Attenuator .....	118
Configuring Movie Servo AF .....	119
Using Auto Slow Shutter .....	120
Miniature Model Effect in Movies (Miniature Effect Movie) .....	121
Recording Video Snapshots.....	122
Recording Time-Lapse Movies.....	124

Configuring Information Display for HDMI Output.....	125
Setting the Type of Digest Movie .....	126
<b>Playback.....</b>	<b>127</b>
Viewing.....	128
Magnifying Images.....	129
Viewing Digest Movies .....	130
Finding Images in an Index.....	131
Editing Movies.....	132
Removing the Beginning/End of Movies.....	132
Extracting Frames of 4K Movies as Stills .....	134
Editing Digest Movies .....	135
Protecting Images .....	136
Protecting Multiple Images .....	136
Rotating Images.....	138
Erasing Images .....	139
Erasing Multiple Images at Once.....	139
Adding Images to Print Orders (DPOF) .....	141
Printing Images Added to the Print Order (DPOF) .....	142
Adding Images to a Photobook.....	143
Correcting Red-Eye.....	144
Cropping.....	145
Resizing Images.....	147
Rating Images .....	148
Viewing Slideshows .....	149
Finding Images Matching Specified Conditions .....	150
Finding Images with the Main Dial .....	151
Combining Video Snapshots.....	152
Starting Playback from the Last Image Displayed .....	154

<b>Wireless Features .....</b>	<b>155</b>
Available Wireless Features.....	156
Saving Camera Images to a Smartphone .....	158
Connecting to Smartphones via Wi-Fi with the Wi-Fi Button.....	161
Restricting Image Viewing .....	164
Features Used with Smartphones.....	165
Sending Images to a Smartphone Automatically as You Shoot...	165
Shooting Remotely as You View a Live Image on the Smartphone .....	165
Controlling the Camera from a Smartphone.....	166
Geotagging Images as You Shoot .....	166
Connecting to Printers via Wi-Fi.....	167
Establishing a Connection via an Access Point.....	169
Sending Images to a Computer Automatically .....	171
Uploading Images to Web Services .....	174
Registering Web Services .....	174
Uploading Images to Web Services.....	178
Reconnecting via Wi-Fi .....	179
Ending Wi-Fi Connections.....	180
Clearing Information of Devices Paired via Bluetooth.....	181
Changing or Deleting Connection Settings .....	182
<b>Function Settings.....</b>	<b>183</b>
Selecting and Creating Folders.....	184
Changing File Numbering .....	185
Configuring Auto Rotation of Vertical Images.....	186
Formatting Memory Cards .....	187
Configuring the Feature Guide.....	188
Using Eco Mode.....	189
Adjusting Power-Saving Features.....	190

Adjusting Screen Brightness .....	191
Adjusting the Date, Time, and Time Zone .....	192
Changing the Language .....	193
Setting the Video System .....	194
Adjusting Beeping .....	195
Adjusting the Volume .....	196
Setting the HDMI Output Resolution .....	197
Customizing Zoom Button Functions .....	198
Switching AF Point Selector and AE Lock Button Functions....	199
Customizing Shooting Information Display .....	200
Setting a Priority for Shooting Display Performance .....	201
Setting the Display Mode .....	202
Lens Retraction Timing .....	203
Setting Reverse Display .....	204
Setting Start-up Screen Display .....	205
Metric / Non-Metric Display .....	206
Configuring Custom Functions .....	207
Customizing Buttons .....	208
Custom Shooting Modes (C1/C2) .....	209
Restoring Default Camera Settings.....	210
Setting Copyright Information to Record in Images .....	211
Downloading Manuals/Software from a QR Code .....	212
Displaying Certification Logos.....	213
Saving Commonly Used Shooting Menu Items (My Menu) .....	214
Renaming My Menu Tabs .....	215
Deleting a My Menu Tab .....	215
Deleting All My Menu Tabs .....	216
Deleting All Added Items.....	216
Customizing My Menu Display .....	217

<b>Accessories .....</b>	<b>218</b>
Optional Accessories.....	219
Power Supplies.....	219
Others.....	219
Printers .....	220
Using Optional Accessories .....	221
Playback on a TV.....	221
Using a Lens Hood (Sold Separately) .....	222
Using Lens Filters (Sold Separately) .....	223
Shooting Remotely .....	224
Using a Remote Switch (Sold Separately) .....	225
Using an External Microphone .....	225
Saving Images to a Computer.....	226
Printing Images .....	227
<b>Tips on Using the Camera.....</b>	<b>229</b>
Camera Basics.....	230
Handling Precautions .....	230
Getting Ready.....	230
Holding the Camera.....	231
Viewfinder .....	232
Adjusting the Screen Angle .....	232
Configuring Camera Features .....	232
Frames on the Shooting Screen.....	232
Playback Display Options.....	233
Shooting.....	234
Shooting with Camera-Determined Settings	
(Auto Mode/Hybrid Auto Mode) .....	234
Shooting Panoramas (Panorama Mode).....	237
Shooting Subjects in Motion (Sports Mode) .....	238
Shooting Specific Scenes (Special Scene Mode) .....	238
Recording a Variety of Movies (Movie Mode).....	239

Shooting in Program AE (P Mode).....	240
Shooting at Specific Shutter Speeds (Tv Mode).....	241
Shooting at Specific Aperture Values (Av Mode).....	241
Shooting at Specific Shutter Speeds and Aperture Values (M Mode) .....	241
Zooming In Closer on Subjects (Digital Zoom).....	242
Locking Image Brightness / Exposure (AE Lock) .....	242
Easily Reacquiring Subjects after Manual Zooming (Framing Assist – Seek) .....	243
Auto Zooming in Response to Subject Movement (Auto Zoom).....	243
Avoiding Lost Subjects after Zooming In (Framing Assist – Lock) .....	244
Shooting Close-Ups (Macro) .....	245
Shooting in Manual Focus Mode .....	245
Changing Image Quality .....	245
Changing the Flash Mode .....	246
Locking Brightness / Exposure in Flash Photography (FE Lock).....	246
Configuring Flash Settings .....	246
Continuous Shooting .....	247
Using the Self-Timer .....	247
Adding a Date Stamp .....	248
Adjusting Image Brightness (Exposure Compensation).....	248
Changing the ISO Speed.....	248
Auto Correction of Brightness and Contrast (Auto Lighting Optimizer).....	249
Capturing Natural Colors (White Balance) .....	249
Shooting with Servo AF .....	250
Choosing the AF Method.....	250
Changing the IS Mode Settings.....	251
Using Digital Tele-Converter .....	251
Storing the Zoom or MF Position.....	251







Changing Movie Recording Size .....	252
Configuring Sound Recording Settings .....	252
Configuring Movie Servo AF .....	252
Using Auto Slow Shutter .....	252
Miniature Model Effect in Movies (Miniature Effect Movie).....	253
Recording Video Snapshots .....	253
Recording Time-Lapse Movies .....	254
Playback.....	255
Viewing .....	255
Magnifying Images .....	255
Viewing Digest Movies.....	255
Editing Movies .....	256
Protecting Images.....	257
Erasing Images.....	257
Adding Images to Print Orders (DPOF).....	258
Adding Images to a Photobook .....	258
Correcting Red-Eye .....	258
Cropping .....	258
Resizing Images .....	258
Rating Images .....	259
Viewing Slideshows.....	259
Finding Images Matching Specified Conditions.....	259
Combining Video Snapshots .....	259
Wireless Features .....	260
Saving Camera Images to a Smartphone .....	260
Features Used with Smartphones .....	261
Connecting to Printers via Wi-Fi.....	262
Sending Images to a Computer Automatically.....	262
Uploading Images to Web Services.....	262
Function Settings .....	264
Selecting and Creating Folders .....	264
Changing File Numbering.....	264

Formatting Memory Cards.....	264
Adjusting Power-Saving Features .....	265
Adjusting Screen Brightness .....	265
Customizing Shooting Information Display.....	265
Configuring Custom Functions .....	265
Custom Shooting Modes (C1/C2).....	266
Restoring Default Camera Settings .....	266
Setting Copyright Information to Record in Images.....	266
Saving Commonly Used Shooting Menu Items (My Menu).....	267
Accessories.....	268
Optional Accessories .....	268
Using Optional Accessories.....	268
Troubleshooting .....	270
On-Screen Information.....	274
When Shooting.....	274
During Playback .....	276
Precautions for Wireless Features.....	278
Security Precautions.....	279
Third-Party Software .....	280
Personal Information and Security Precautions.....	283
Trademarks and Licensing.....	284
Disclaimer .....	285
Index .....	286

# Common Camera Operations

## Shoot

---

- Use camera-determined settings (Auto Mode, Hybrid Auto Mode)
  -  52,  54
- Shoot yourself under optimal settings (Self Portrait)
  -  60
- Shoot panoramas (Panoramic Shot)
  -  55

Shooting people well



Portraits  
( 57)

Matching specific scenes



Sports  
( 56)



Handheld  
Night Scene  
( 57)



Fireworks  
( 57)



Food  
( 57)



15



## Applying special effects



Smooth Skin

(📖57)



Monochrome

(📖61)



Soft Focus

(📖61)



Fish-Eye Effect

(📖61)



Like Oil Paintings

(📖61)



Like Watercolor Paintings

(📖61)



Toy Camera Effect

(📖61)



Miniature Effect

(📖64, 📖121)

- Focus on faces
  - 📖52, 📖57, 📖107
- Without using the flash (Flash Off)
  - 📖86
- Include yourself in the shot (Self-Timer)
  - 📖93
- Add a date stamp
  - 📖94
- Movie clips and photos together
  - 📖54





## ▶ View

- View images
  - 📖128
- Automatic playback (Slide Show)
  - 📖149
- On a TV
  - 📖221





16



- Browse through images quickly
  -  131,  150,  151
- Erase images
  -  139

## Record/View Movies

---

- Record movies
  -  52,  65
- View movies
  -  128

## Print

---

- Print pictures
  -  141,  167,  227





## Save

---

- Save images to a computer
  -  226

## Use Wi-Fi Features

---

- Send images to a smartphone
  -  158,  165
- Print pictures
  -  167
- Share images online
  -  174
- Send images to a computer
  -  171

# Safety Instructions

- Be sure to read these instructions in order to operate the product safely.
- Follow these instructions to prevent injury or harm to the operator of the product or others.



## WARNING

Denotes the risk of serious injury or death.

- Keep the product out of the reach of young children.  
A strap wrapped around a person's neck may result in strangulation.
- Use only power sources specified in this instruction manual for use with the product.
- Do not disassemble or modify the product.
- Do not expose the product to strong shocks or vibration.
- Do not touch any exposed internal parts.
- Stop using the product in any case of unusual circumstances such as the presence of smoke or a strange smell.
- Do not use organic solvents such as alcohol, benzine or paint thinner to clean the product.
- Do not get the product wet. Do not insert foreign objects or liquids into the product.
- Do not insert foreign objects or liquids into the product.
- Do not use the product where flammable gases may be present.  
This may cause electric shock, explosion or fire.
- For products featuring a viewfinder, do not look through the viewfinder at strong light sources such as the sun on a bright day or lasers and other strong artificial light sources.  
This may harm your vision.
- Observe the following instructions when using commercially available batteries or provided battery packs.
  - Use batteries/battery packs only with their specified product.
  - Do not heat batteries/battery packs or expose them to fire.
  - Do not charge batteries/battery packs using non-authorized battery chargers.
  - Do not expose the terminals to dirt or let them come into contact with metallic pins or other metal objects.
  - Do not use leaking batteries/battery packs.
  - When disposing of batteries/battery packs, insulate the terminals with tape or other means.

This may cause electric shock, explosion or fire.

If a battery/battery pack leaks and the material contacts your skin or clothing, flush the exposed area thoroughly with running water. In case of eye contact, flush thoroughly with copious amounts of clean running water and seek immediate medical assistance.



- Observe the following instructions when using a battery charger or AC adapter.
  - Periodically remove any dust buildup from the power plug and power outlet using a dry cloth.
  - Do not plug in or unplug the product with wet hands.
  - Do not use the product if the power plug is not fully inserted into the power outlet.
  - Do not expose the power plug and terminals to dirt or let them come into contact with metallic pins or other metal objects.
  - Do not touch the battery charger or AC adapter connected to a power outlet during lightning storms.
  - Do not place heavy objects on the power cord. Do not damage, break or modify the power cord.
  - Do not wrap the product in cloth or other materials when in use or shortly after use when the product is still warm in temperature.
  - Do not leave the product connected to a power source for long periods of time.

This may cause electric shock, explosion or fire.

- Do not allow the product to maintain contact with the same area of skin for extended periods of time during use.

This may result in low-temperature contact burns, including skin redness and blistering, even if the product does not feel hot. The use of a tripod or similar equipment is recommended when using the product in hot places and for people with circulation problems or less sensitive skin.

- Follow any indications to turn off the product in places where its use is forbidden.

Not doing so may cause other equipment to malfunction due to the effect of electromagnetic waves and even result in accidents.



## CAUTION

Denotes the risk of injury.

- Do not fire the flash near the eyes.

It may hurt the eyes.

- Strap is intended for use on the body only. Hanging the strap with any product attached on a hook or other object may damage the product. Also, do not shake the product or expose the product to strong impacts.

- Do not apply strong pressure on the lens or allow an object to hit it.

This may cause injury or damage to the product.

- Flash emits high temperatures when fired. Keep fingers, any other part of your body, and objects away from the flash unit while taking pictures.

This may cause burns or malfunction of the flash.

- Do not leave the product in places exposed to extremely high or low temperatures.

The product may become extremely hot/cold and cause burns or injury when touched.

## CAUTION

Denotes the possibility of property damage.

- Do not aim the camera at intense light sources, such as the sun on a clear day or an intense artificial light source.

Doing so may damage the image sensor or other internal components.

- When using the camera on a sandy beach or at a windy location, be careful not to allow dust or sand to enter the camera.
- Wipe off any dust, grime, or other foreign matter on the flash with a cotton swab or cloth.

The heat emitted from the flash may cause foreign matter to smoke or the product to malfunction.

- Remove and store the battery pack/batteries when you are not using the product. Any battery leakage that occurs may cause product damage.
- Before you discard the battery pack/batteries, cover the terminals with tape or other insulators.

Contacting other metal materials may lead to fire or explosions.

- Unplug any battery charger used with the product when not in use. Do not cover with a cloth or other objects when in use.

Leaving the unit plugged in for a long period of time may cause it to overheat and distort, resulting in fire.

- Do not leave any dedicated battery packs near pets. Pets biting the battery pack could cause leakage, overheating, or explosion, resulting in product damage or fire.

- If your product uses multiple batteries, do not use batteries that have different levels of charge together, and do not use old and new batteries together. Do not insert the batteries with the + and – terminals reversed.

This may cause the product to malfunction.

- When card reading/writing is in progress, do not turn the camera off, open the memory card/battery cover, or shake or hit the camera.

Doing so may corrupt images or damage the camera or memory card.

- Do not force the memory card into the camera facing the wrong way.

This could damage the camera.



# Camera Basics

Basic information and instructions, from initial preparations to shooting and playback.

## Getting Ready

### ● Attaching the Strap

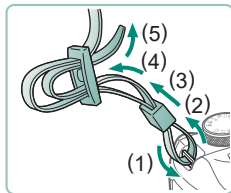

- 1** Attach the included strap to the strap mount.

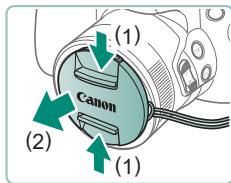

- 2** Attach the lens cap to the strap.

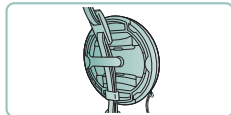
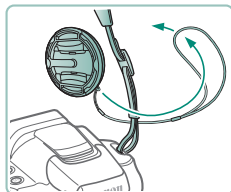

## ● Charging the Battery Pack

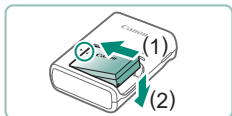

**1** Insert the battery pack in the charger.

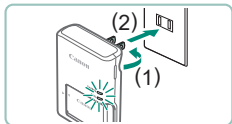

**2** Charge the battery pack.

- Lamp colors
  - Charging: Orange
  - Fully charged: Green



**3** Remove the battery pack.

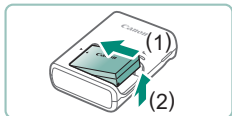

## ● Preparing a Memory Card

---

Use the following memory cards (sold separately), in any capacity.

- SD memory cards\*<sup>1</sup>
- SDHC memory cards\*<sup>1\*2</sup>
- SDXC memory cards\*<sup>1\*2</sup>



\*1 Cards conforming to SD standards. However, not all memory cards have been verified to work with the camera.

\*2 UHS-I memory cards are also supported.

## ● Inserting/Removing the Battery Pack and Memory Card

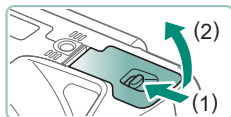

**1** Open the cover.

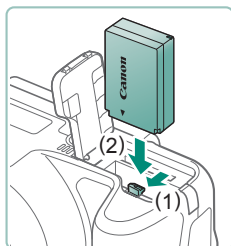

**2** Insert the battery pack.

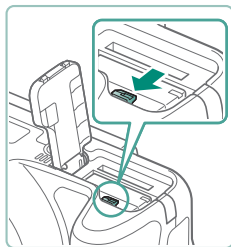

To remove:

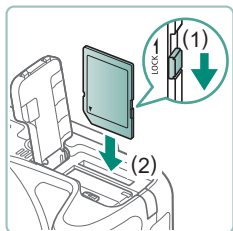

**3** Insert the memory card.

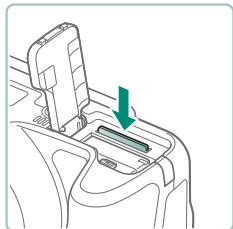

To remove:

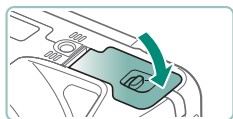

**4** Close the cover.



## ● Setting the Date, Time, Time Zone, and Language

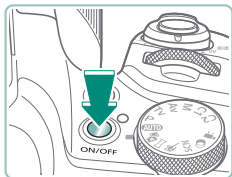

1 Turn the camera on.

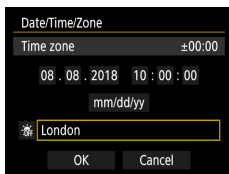

2 Set the time zone.

- ◀/▶ buttons to choose a time zone →  
Ⓢ button

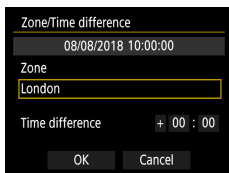

- Ⓢ button

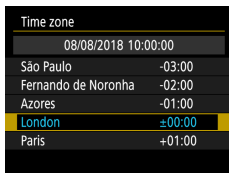

- ▲/▼ buttons to choose a time zone →  
Ⓢ button → ◀/▶ buttons to choose [OK]  
→ Ⓢ button

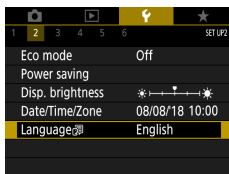
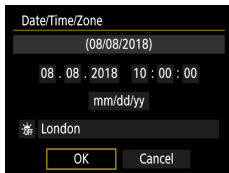
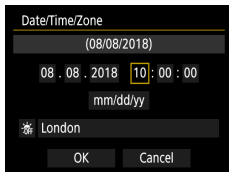

### 3 Set the date and time.

- ◀/▶ buttons to choose the date or time  
→ ⌚ button → ▲/▼ buttons to adjust → ⌚ button
- Choose [OK] → ⌚ button

### 4 Set the display language.

- ▲/▼ buttons to choose [Language] → ⌚ button
- ▲/▼/◀/▶ buttons to choose a language  
→ ⌚ button





## Holding the Camera



- Place the strap around your neck.
- When shooting, keep your arms close to your body and hold the camera securely to prevent it from moving.





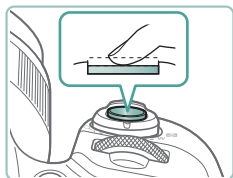

## 4 Focus (press halfway).

- The camera beeps after focusing.
- An AF point is displayed around positions in focus.

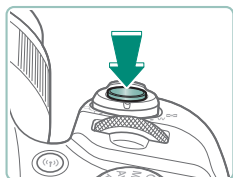

## 5 Shoot (press fully).

### When recording movies:

- [●REC] is displayed during recording.
- To stop movie recording, press the movie recording button again.

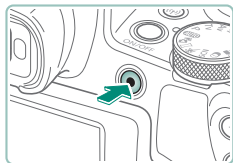

## Viewing

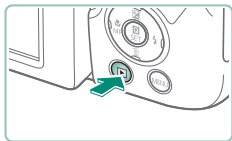

1 Press the  button.



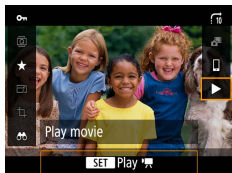

2 Choose images.

- Movies are labeled with .



**When playing movies:**



-  button (twice)
- Press the  buttons to adjust the volume.

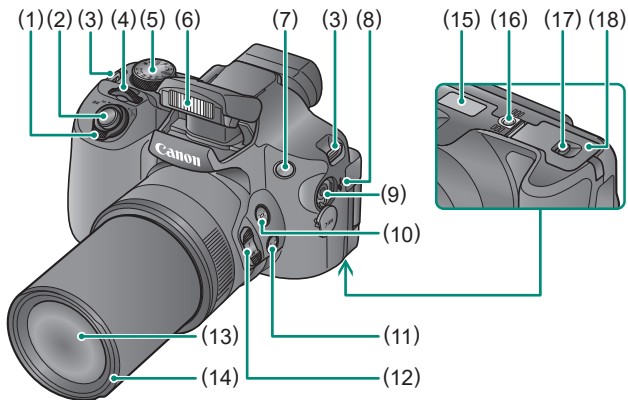

# Part Names

## Front



- |  |   |
|--|---|
| (1) Zoom lever<br>Shooting: <b>T</b> (telephoto) /<br><b>W</b> (wide angle)<br>Playback: <b>Q</b> (magnify) / <b>☐</b> (index) | (9) External microphone IN terminal   |
| (2) Shutter button   | (10)  (Framing Assist – Seek) button |
| (3) Strap mount  | (11)  (Framing Assist – Lock) button |
| (4) Main dial  | (12) Zoom button  |
| (5) Mode dial  | (13) Lens   |
| (6) Flash  | (14) Lens hood/filter adapter mount   |
| (7) Lamp   | (15) Serial number  |
| (8) Speaker  | (16) Tripod socket  |
|  | (17) Memory card/battery cover lock   |
|  | (18) Memory card/battery cover  |

## Back

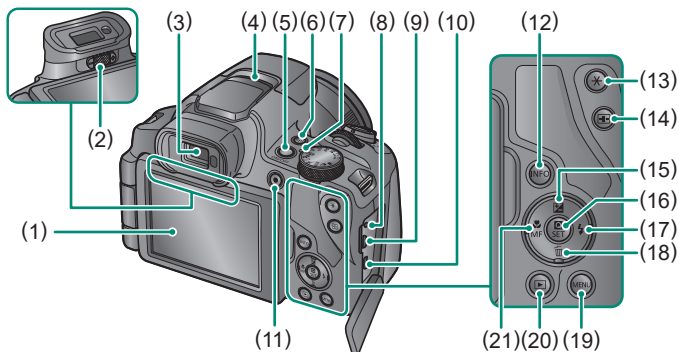

- (1) **Screen**  
Opens to the left about 180° and rotates up and down.
- (2) **Dioptic adjustment knob**
- (3) **Viewfinder**
- (4) **Microphone**
- (5) **Power button**
- (6) **(Wi-Fi) button**
- (7) **Indicator**
- (8) **Remote switch terminal**
- (9) **DIGITAL terminal**
- (10) **HDMI™ terminal**
- (11) **Movie recording button**  
Movies can also be recorded in modes other than Movie mode.
- (12) **INFO button**
- (13) **✳ (AE lock) button**
- (14) **▣ (AF point selector) button**
- (15) **⊠ (Exposure compensation) / ▲ Up button**
- (16) **⊞ (Quick Control) button**  
Displays the Quick Control screen. Also used to confirm selected settings.
- (17) **⚡ (Flash) / ▶ Right button**
- (18) **🗑 (Single-image erase) / ▼ Down button**
- (19) **MENU button**  
Used to display menu screens.
- (20) **▶ (Playback) button**
- (21) **🌸 (Macro) / MF (Manual focus) / ◀ Left button**

# Viewfinder

Using the viewfinder helps you concentrate on keeping subjects in focus.

## 1 Switch the display mode.

- To use the viewfinder, activate it by holding it near your eye.



## 2 Adjust the diopter.

- Adjust it with the screen open.



## Adjusting the Screen Angle

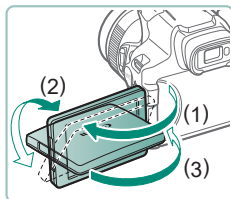

- Toward (1): The screen opens to about 180°.
- Toward (2): The screen swivels about 180°.
- (3): Tilt the screen toward the front to close it.





## Indicator Display

The indicator on top remains lit or blinks depending on camera status.

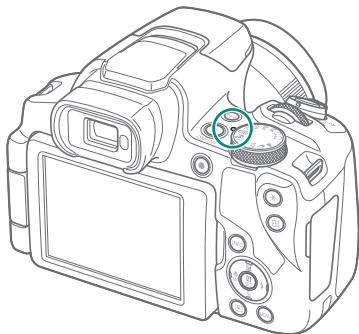





Color	Indicator Status	Camera Status
Green	On	<ul style="list-style-type: none"><li>● Recording stills to the memory card, or reading stills from the card</li></ul>
	Slow blinking	<ul style="list-style-type: none"><li>● Display off</li></ul>
	Blinking	<ul style="list-style-type: none"><li>● Recording movies to the memory card, or reading movies from the card</li><li>● Transmitting via Wi-Fi</li></ul>

## Setting a Shooting Mode

Use the mode dial to access each shooting mode.



- (1) Tv Mode **Tv**  
Set the shutter speed before shooting (📖68).
- (2) P Mode **P**  
Set a variety of settings before shooting (📖67).
- (3) Auto Mode **AUTO**  
Fully automatic shooting, with camera-determined settings (📖52).
- (4) Hybrid Auto Mode   
Automatically record a clip of the scene before each shot (📖54).
- (5) Panorama Mode   
Create panoramas combining a series of shots (📖55).
- (6) Sports Mode   
Shoot continuously as the camera focuses on moving subjects (📖56).
- (7) Av Mode **Av**  
Set the aperture value before shooting (📖69).
- (8) M Mode **M**  
Set the shutter speed and aperture value before shooting to obtain the desired exposure (📖70).
- (9) C1 / C2 Mode **C1 / C2**  
Save commonly used shooting modes and your configured function settings for reuse (📖209).
- (10) Movie Mode   
Record a variety of movies (📖65).
- (11) Creative Filters Mode   
Add a variety of effects to images when shooting (📖61).
- (12) Special Scene Mode **SCN**  
Shoot with settings for specific scenes (📖57).

# Configuring Camera Features

## Quick Control Screen



1 Press the **SET** button.

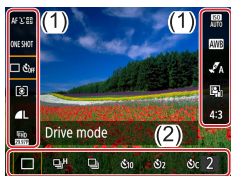

- (1) Setting items
- (2) Setting options



2 Choose a setting item.



3 Choose a setting option.

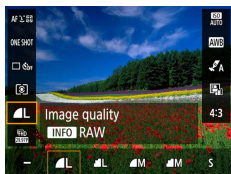

- Configure items labeled with a **[INFO]** icon by pressing the **INFO** button.



## 4 Complete the setting.



## Menu Screen

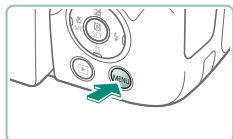

## 1 Press the MENU button.

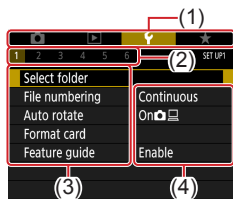

## 2 Choose a tab.

- (1) Main tab
- (2) Sub-tab
- (3) Setting items
- (4) Setting options

- Use the zoom lever to choose a main tab.

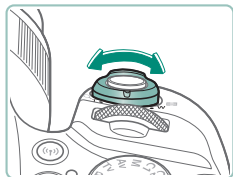

- Use the buttons or dial to choose a sub-tab.

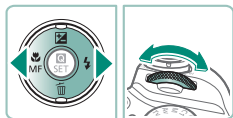



### 3 Choose a setting item.

- Some items are selected with the ▲/▼ buttons on a different screen, after you press the  button initially.



### 4 Choose a setting option.



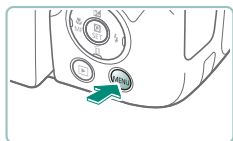

### 5 Complete the setting.



### 6 Return to the shooting screen.

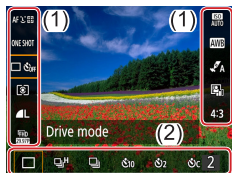









## Features Available on the Quick Control Screen



Press the  button on shooting or playback screens to access the Quick Control screen, where you can adjust settings. Choose a setting item on the right or left to display setting options for it on the bottom.

- (1) Setting items  
(2) Setting options

The following settings are available in **P** mode. Available setting items and options vary by shooting mode.

	AF method	Choose an auto focus (AF) mode for the scene you are shooting.
	AF operation	Choose <b>[SERVO]</b> to keep subjects in focus while you press the shutter button halfway.
	Drive mode*	Set up continuous shooting or the self-timer.
	Metering mode	Choose how brightness is measured.
	Image quality*	Choose the size (number of pixels) and compression (quality) of your shots.
	Movie rec. size*	Choose the recording size and frame rate for movies.
	ISO speed	Choose the ISO speed.
	White balance	Shoot with natural-looking colors under specific types of lighting.
	Style settings	Choose color tone, contrast, and other image details.
	Auto Lighting Optimizer	Choose the level of auto correction for brightness and contrast.
<b>4:3</b>	Still img aspect ratio*	Choose the aspect ratio for stills.









\* Also available in **AUTO** mode.

# Menu Settings

Use menu screens to configure a variety of camera features. To access menu screens, press the **MENU** button. Setting items are organized into four main groups and multiple tabs for each group.

You can configure the following setting items on menu screens. Available setting items vary by shooting mode.





## Shooting settings

- Shooting mode
- Image quality
- Still img aspect ratio
- Image review
- Flash settings
- Drive mode
- Date stamp 
- Expo.comp./AEB
-  ISO speed settings
-  ISO speed settings
- Auto Lighting Optimizer
- Metering mode
- Metering timer
- Expo. simulation
- White balance
- Custom White Balance
- WB Shift/Bkt.
- Style settings
- HDMI info disp
- AF operation
- AF method
- Continuous AF
- AF-assist beam firing
- MF peaking settings
- Safety MF
- MF-point zoom
- IS settings
-  Auto level
- Digital zoom
- Recall zoom/MF settings
- Digest type
-  Display area
-  Auto zoom
-  Centering
- Movie rec. size
- Sound recording
- Movie Servo AF
-  Auto slow shutter
- Video snapshot
- Time-lapse movie
- Remote control

## ▶ Playback settings

- Protect images
- Rotate image
- Erase images
- Print order
- Photobook Set-up
- Red-eye correction
- Cropping
- Resize
- Rating
- Slide show
- Set image search conditions
- Image jump w/ 
- Create album
- Histogram disp
- View from last seen

## 🔧 Function settings

- Select folder
- File numbering
- Auto rotate
- Format card
- Feature guide
- Eco mode
- Power saving
- Disp. brightness
- Date/Time/Zone
- Language 
- Video system
- Beep
- Volume
- HDMI resolution
-  button function
- Switch   button
- Shooting info. disp.
- Disp. performance
- Display settings
- Lens retraction
- Reverse display
- Start-up image
- Units
- Wireless communication settings
- GPS settings
- Custom Functions (C.Fn)
- Custom shooting mode (C1, C2)
- Reset camera
- Copyright information
- Manual/software URL
- Certification Logo Display
- Firmware

## ★ My Menu

- Add My Menu tab
- Delete all My Menu tabs
- Delete all items
- Menu display





## Shooting Mode Screen

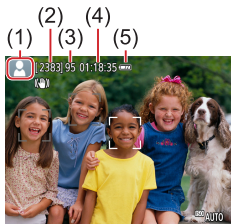

- (1) Shooting mode / Scene icon
- (2) Recordable shots
- (3) Maximum continuous shots
- (4) Movie recording time available
- (5) Battery level

## Frames on the Shooting Screen

Frames for focusing (AF points) are displayed on the shooting screen.

White frame	Displayed around the subject or person's face detected as the main subject.
Green frame	Displayed after the camera focuses when you press the shutter button halfway.
Blue frame	Displayed as the camera continues to focus on moving subjects. Displayed as long as you press the shutter button halfway.
Yellow frame	Displayed if the camera cannot focus when you press the shutter button halfway.



# Shooting Display Options

You can switch shooting screen display to view other information.

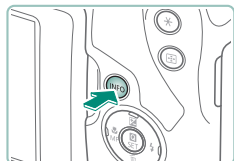

1 Press the INFO button.

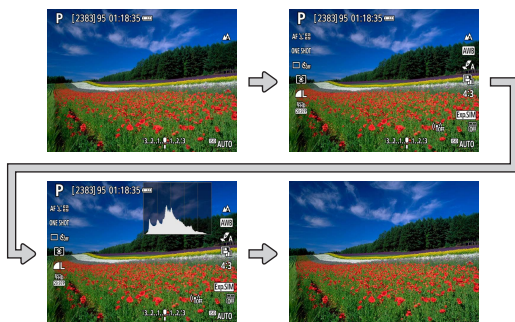

# Playback Display Options

You can switch playback screen display to view other information.

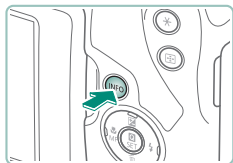

1 Press the **INFO** button.

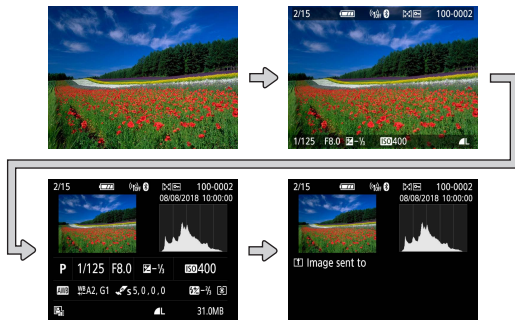

## Switching Histograms

You can switch between displaying a brightness histogram (for checking the general exposure level and overall gradation) and an RGB histogram (for checking saturation and gradation of red, green, and blue).

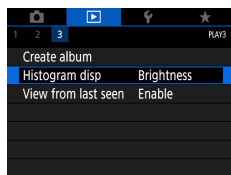

### 1 [Histogram disp]



# On-Screen Keyboard

Use the on-screen keyboard to enter information. Use the ▲/▼/◀/▶ buttons to choose a key, and then press the  button.

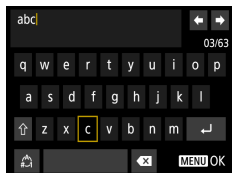

## Moving the cursor

- [←]/[→]

## Switching input modes

- [↑]: Switch to uppercase
- [↻]: Switch to numbers or symbols

## Deleting characters

- [←X]

## Entering line breaks

- [↵]

## Returning to the previous screen

- MENU button

# Shooting

Easily shoot in simple modes, or take more sophisticated shots using a variety of features.



## Shooting with Camera-Determined Settings (Auto Mode/Hybrid Auto Mode)

Use Auto mode for fully automatic selection of the optimal settings for the scene, based on the subject and shooting conditions determined by the camera.



**1** Enter AUTO mode.

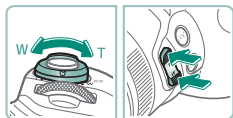

**2** Zoom in or out, as needed.

- Move the zoom lever or press the zoom buttons as you watch the screen.

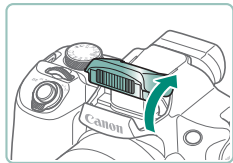

**When using the flash:**

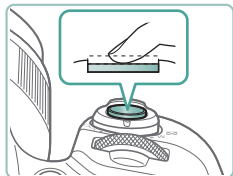

**3** Focus (press halfway).







- The camera beeps after focusing.
- An AF point is displayed around positions in focus.



#### 4 Shoot (press fully).

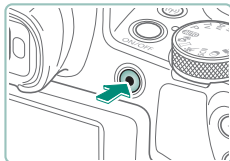

#### When recording movies:

- [●REC] is displayed during recording.
- To stop movie recording, press the movie recording button again.





## Shooting in Hybrid Auto Mode

Also record 2–4 second clips of scenes before each shot automatically, just by shooting stills. Each clip, which ends with the still image and a shutter sound, forms an individual chapter. The camera creates a short digest movie of the day by combining the clips.

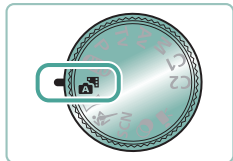

**1** Enter  mode.

**2** Focus and shoot.





# Shooting Panoramas (Panorama Mode)

Create a panorama combining shots captured continuously as you move the camera one direction while holding the shutter button all the way down.

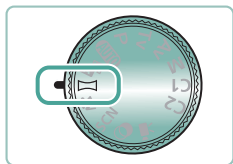

**1** Enter  mode.

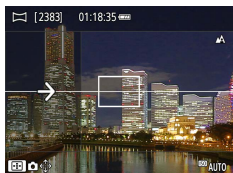

**2** Choose a shooting direction.

- Use the  button to choose the direction you will shoot.
- An arrow is displayed showing the direction to move the camera.

**3** Press the shutter button halfway.

- Keeping the shutter button halfway down, focus on the subject.

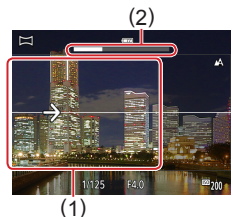

**4** Shoot.

- Holding the shutter button all the way down, move the camera at a constant speed in the direction of the arrow.
- The area displayed clearly (1) is captured.
- A shooting progress indicator (2) is displayed.
- Shooting stops when you release the shutter button, or when the progress indicator is completely white.





# Shooting Subjects in Motion (Sports Mode)

Shoot continuously as the camera focuses on moving subjects.

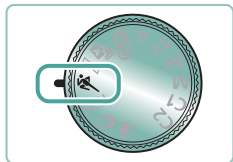

**1** Enter  mode.



**2** Focus.

- While you are pressing the shutter button halfway, the camera will continue to adjust focus and image brightness where the blue frame is displayed.

**3** Shoot.

- Hold the shutter button all the way down to shoot continuously.







## Shooting Specific Scenes (Special Scene Mode)

Choose a mode matching the shooting scene, and the camera will automatically configure the settings for optimal shots. Try taking some test shots first to make sure you obtain the desired results.

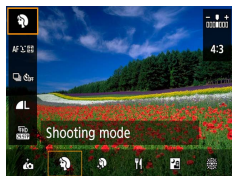

**1** Enter SCN mode.



**2**  button →  → choose an option

**3** Shoot.





 Self Portrait

For self-portraits, customizable image processing includes skin smoothing as well as brightness and background adjustment to make yourself stand out.

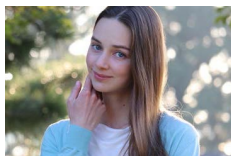

 Portrait

Capture subjects that stand out against a blurred background, with smooth skin tone and soft-looking hair.



 Smooth skin

Process images to make skin look smoother.



 Food

Adjust color tones to make food look fresh and vibrant.





 Handheld Night Scene

Take beautiful shots of evening scenes or portraits with evening scenery in the background.



 Fireworks

Vivid shots of fireworks.





## Shooting Yourself under Optimal Settings (Self Portrait Mode)

1 Choose [Auto].

2 Configure the settings.

- INFO button → ▲/▼ buttons to choose [Brightness] or [Smooth skin effect] → ◀/▶ buttons to set the level → Ⓢ button
- Use the ◀ button to set [Background blur].

3 Open the screen.

4 Shoot.

- Hold the camera steady as you shoot, because the camera shoots twice and processes the images when you press the shutter button all the way down with background blur set to [Auto].

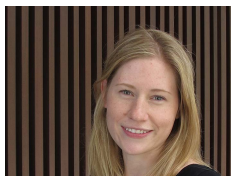
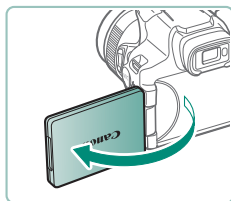
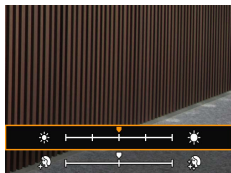





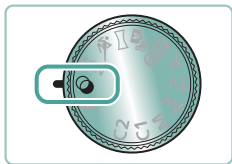

## Shooting with Image Effects (Creative Filters Mode)

Add a variety of effects to images when shooting. Try taking some test shots first to make sure you obtain the desired results.

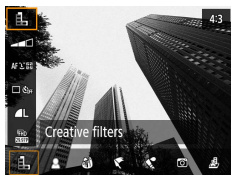

**1** Enter  mode.



**2**  button →  → choose an option

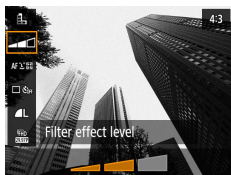

**3** Choose an effect level.

- Use the   buttons to set the level.

**4** Shoot.





 Grainy B/W

Take black and white shots with a rough, gritty feeling.



 Soft focus

Shoot with a simulated soft focus filter effect, for a gentle ambiance.

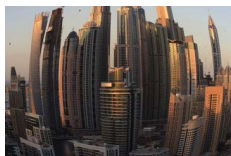

 Fish-eye effect

Shoot with the distorting effect of a fish-eye lens.



 Art bold effect

Make subjects look more substantial, like subjects in oil paintings.



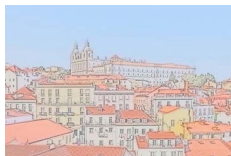

 Water painting effect

Soften colors, for photos resembling watercolor paintings.



 Toy camera effect

Shoot images that resemble shots from a toy camera, with vignetting and different color overall.



 Miniature effect

Create the effect of a miniature model, by blurring image areas outside a selected area.





## Shots Resembling Miniature Models (Miniature Effect)



- 1 Choose [MENU].
- 2 Set the area to keep in focus (scene frame).
  - INFO button → ▲/▼ buttons to move the frame → [SET] button
- 3 Set the position in focus (AF point).
  - ▲/▼/◀/▶ buttons to move the AF point → [SET] button
- 4 Shoot.





## Recording a Variety of Movies (Movie Mode)

Full-featured mode offers miniature effect movies ( 121), video snapshots ( 122), time-lapse movies ( 124), and more.



**1** Enter mode.

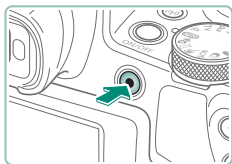

**2** Start recording.

- [●REC] is displayed during recording.
- To stop movie recording, press the movie recording button again.



## Recording Movies at Specific Shutter Speeds and Aperture Values (Movie Manual Exposure)

Set the shutter speed, aperture value, and ISO speed before recording.

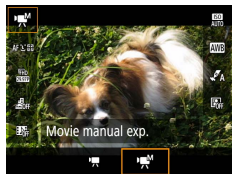

**1** button → → choose

- Press the button.



65





**2** Set the ISO speed.

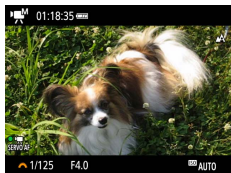

**3** Set the shutter speed and aperture value.

- Shutter speed:  dial
- Aperture value:  button →  dial

**4** Start recording.





## Shooting in Program AE (P Mode)

Shutter speed and aperture value are automatically adjusted to suit subject brightness.

**P** mode offers flexibility in setting AF operation, metering modes, and several other features.

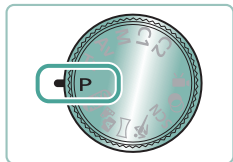

**1** Enter **P** mode.

**2** Configure each feature as needed.

**3** Shoot.





## Shooting at Specific Shutter Speeds (Tv Mode)

Set the shutter speed before shooting. The camera automatically adjusts the aperture value to suit your shutter speed.

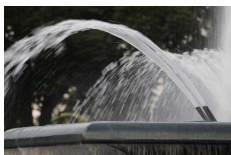

Slow



Fast



**1** Enter **Tv** mode.

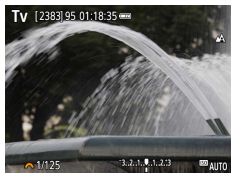

**2** Set the shutter speed.



**3** Shoot.



68







## Shooting at Specific Aperture Values (Av Mode)

Set the aperture value before shooting. The camera automatically adjusts the shutter speed to suit your aperture value.

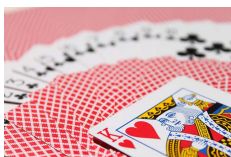

Small value



Large value



**1** Enter **Av** mode.



**2** Set the aperture value.



**3** Shoot.





# Shooting at Specific Shutter Speeds and Aperture Values (M Mode)

Set the shutter speed and aperture value before shooting to obtain the desired exposure.



**1** Enter **M** mode.

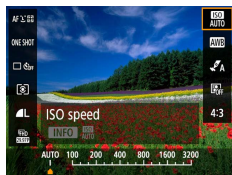

**2**  button → set the ISO speed



**3** Set the shutter speed and aperture value.

- Shutter speed:  dial
- Aperture value:  button →  dial

**4** Shoot.





## Zooming In Closer on Subjects (Digital Zoom)

When distant subjects are too far away to enlarge using the optical zoom, use digital zoom for up to about 260x enlargement.

AUTO

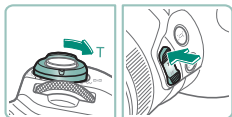

### 1 Press the zoom lever or zoom button toward **T**.

- Keep pressing the lever or button.
- Zooming stops at the largest zoom factor before the image becomes noticeably grainy, which is then indicated on the screen.

### 2 Press toward **T** again.

- The camera zooms in even closer on the subject.
- (1) is the current zoom factor.

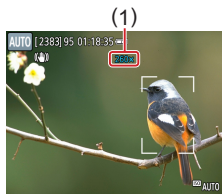

71





## Locking Image Brightness / Exposure (AE Lock)

Exposure can be locked when shooting stills and recording movies, or focus and exposure can be set separately.



Without AE lock



AE lock

P

- 1 Aim at a subject for fixed exposure.
- 2 Press the **[\*]** button.

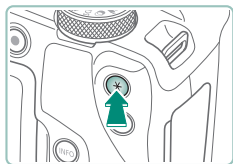

- **[\*]** is displayed, and the exposure is locked.
  - This setting is unlocked automatically after the metering timer (📖 101) runs out.
- 3 **Compose the shot and shoot.**
    - AE is unlocked once **[\*]** is no longer displayed.



72





## Easily Reacquiring Subjects after Manual Zooming (Framing Assist – Seek)

If you lose track of a subject while zoomed in, you can find it more easily by temporarily zooming out.

AUTO



### 1 Press and hold the button.

- The camera zooms out and displays a white frame around the area shown before you pressed the  button.

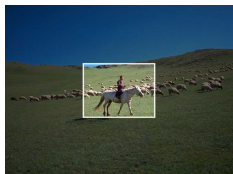

### 2 Aim the camera so that the subject enters the white frame.



### 3 Release the button.

- The camera zooms in to fill the screen with the area that was in the white frame in step 2.



73





## Display Area Options

The area shown after the  button is pressed can be adjusted.

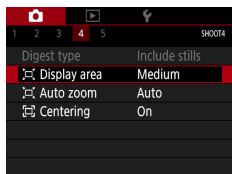

### 1 [Display area]







# Auto Zooming in Response to Subject Movement (Auto Zoom)

The camera automatically zooms in and out to keep a detected face (📖 107) at a constant size. If the person moves closer, the camera automatically zooms out, and vice versa. This size can also be adjusted.

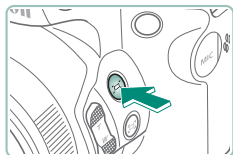
AUTO



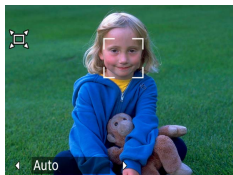

## 1 Press and release the button quickly.

-  is displayed.
- A white frame is displayed around the detected face, and the camera zooms in and out to keep the subject on the screen.
- When multiple faces are detected, a white frame is displayed around the main subject's face and up to two gray frames around other faces.



## 2 Shoot.

- Auto zooming is canceled when you press the  button again, and  Auto: off is displayed.



75





## Adjusting the Constant Face Display Size

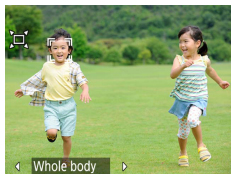

- With [Auto: on], press the ◀/▶ buttons to choose the desired option.
- The camera zooms automatically to keep faces at the specified size.

Auto	Auto zoom to prevent subjects from moving off the screen. When multiple faces are detected, the camera zooms to keep these subjects on the screen.
Face	Keep faces large enough to show facial expressions clearly.
Upper body	Keep faces small enough to show the person's upper body.
Whole body	Keep faces small enough to show the person's entire body.
Manual	Keep faces at the size specified by moving the zoom lever. Release the zoom lever once the desired size has been obtained.









## Avoiding Lost Subjects after Zooming In (Framing Assist – Lock)

The camera can reduce camera shake after you zoom in and can center your subject to help you avoid losing it.

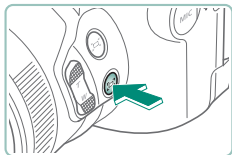
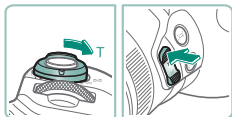
AUTO



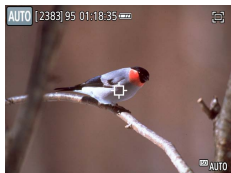

### 1 Zoom in toward the telephoto end and press the button.

-  is displayed, and the camera applies image stabilization for shooting at the telephoto end.



### 2 Choose a subject to keep near the center.

-  is displayed in the center of the screen.
- Aim the camera so that  is on the subject, and then press the  button or press the shutter button halfway.



77



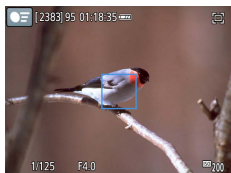

- The subject is tracked to keep it near the center of the screen.

### 3 Shoot.



## Disabling Centered Subject Display

Centered display of detected subjects can be disabled. In this case as well, image stabilization for zoomed-in subjects is applied.

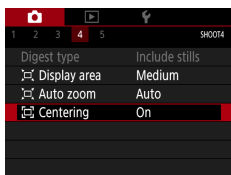

### 1 Centering] → [Off]



## Shooting Close-Ups (Macro)

To restrict the focus to subjects at close range, set the camera to [🌻].

P

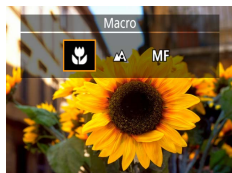

**1** Press the ◀ button to choose [🌻].

**2** Shoot.



79





# Shooting in Manual Focus Mode

When focusing is not possible in AF mode, use manual focus. To make focusing easier, magnify the display.

P



## 1 Set the camera to manual focus.

- Use the ◀ button to choose [MF].
- [MF] and the MF indicator are displayed.



## 2 Focus.

- Using the MF indicator (1, which shows distance and focal position) as a guide, press and hold the ▲/▼ buttons to set the general focal position.
- Briefly press the ▲/▼ buttons to fine-tune the focal position as you watch the magnified display. To adjust the magnification, press the ▶ button.
- To move the enlarged area, press the [ ] button and then use the ▲/▼/◀/▶ buttons. To return it to the center, press the INFO button.

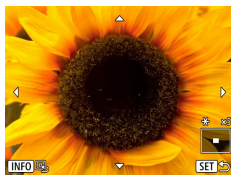

## 3 Shoot.





## Easily Identifying the Focus Area (MF Peaking)

Edges of subjects in focus are displayed in color to make manual focusing easier. You can adjust the colors and the sensitivity (level) of edge detection.

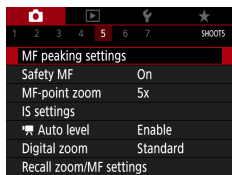

**1**  [MF peaking settings] → [Peaking] → [On]

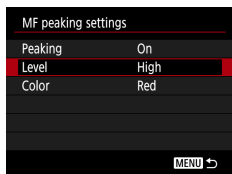

**2** Configure the settings.





## Shooting with AF Lock

The focus can be locked. After you lock the focus, the focal position will not change even when you release your finger from the shutter button.

P



### 1 Lock the focus.

- With the shutter button pressed halfway, press the ◀ button.
- The focus is now locked, and [MF] and the MF indicator are displayed.

### 2 Compose the shot and shoot.

- To unlock the focus, press the ◀ button again, and choose [▲] or [▼].





## Changing Image Quality

Choose from five combinations of size (pixel count) and compression (image quality). Also specify whether to capture images in RAW format.

AUTO

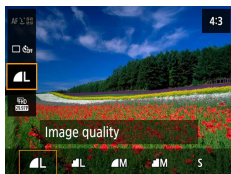

- 1  button →  → choose an option



## Capturing in RAW Format

The camera can capture images in JPEG and RAW format. RAW images are “raw” data, before processing to create JPEGs.

P

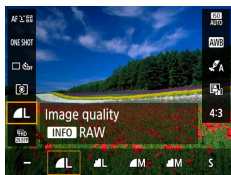

- 1  → press the INFO button

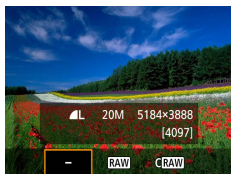

- 2 Choose the method of shooting in RAW.



83





## Changing the Aspect Ratio

The image aspect ratio (ratio of width to height) can be changed.



4:3



3:2

AUTO



- 1  button → [4:3] → choose an option



84







## Changing the Image Display Period after Shots

How long images are shown after shots is adjustable.

AUTO

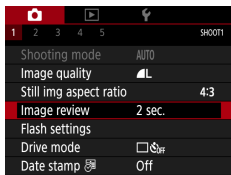

### 1 [Image review]

Off	No image display after shots.
2 sec., 4 sec., 8 sec.	Images are displayed for the specified time. Even while the shot is displayed, you can prepare for the next shot by pressing the shutter button halfway again.
Hold	Images are displayed until you press the shutter button halfway.





## Changing the Flash Mode

You can change the flash mode to match the shooting scene.

P

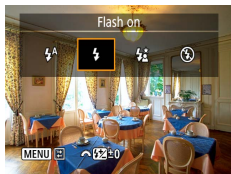

- 1 Press the **▶** button to choose a flash mode.

Auto flash	Fires automatically in low-light conditions.
Flash on	Fires for each shot.
Slow synchro	Fires to illuminate the main subject (such as people) while shooting at a slower shutter speed to illuminate backgrounds out of flash range.
Flash off	For shooting without the flash.





# Locking Brightness / Exposure in Flash Photography (FE Lock)

Retain the flash output level.



FE lock



Without FE lock (overexposed)

P

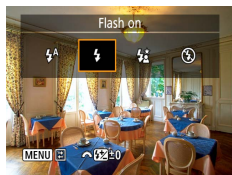

**1** Raise the flash and set it to [⚡] or [⚡\*].

**2** Aim at a subject for fixed exposure.



**3** Press the ✖ button.



- The flash fires, a circle is displayed showing the metering range, and [⚡\*] is displayed, indicating that the flash output level has been retained.

**4** Compose the shot and shoot.



87





## Configuring Flash Settings

Several flash settings are available.

P

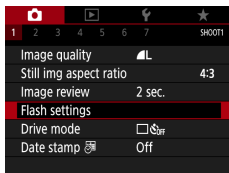

### 1 [Flash settings]



## Adjusting Flash Exposure Compensation

You can adjust the flash exposure from  $-2$  to  $+2$  stops, in  $1/3$ -stop increments.



Set toward -



Set toward +

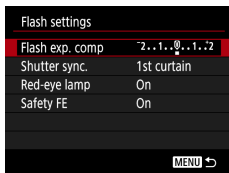

### 1 [Flash exp. comp]



88





## 2 Set the amount of compensation.

- ◀▶ buttons

## Adjusting Flash Output

Choose from three flash levels in **Tv/Av/M** modes.



Flash output: Minimum



Flash output: Maximum

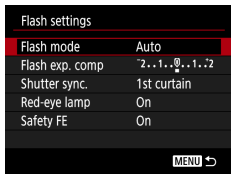

## 1 [Flash mode] → [Manual]

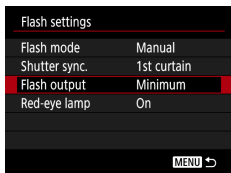

## 2 [Flash output]





## Changing the Flash Timing

The timing of flash firing relative to shutter release is adjustable.



1st curtain



2nd curtain

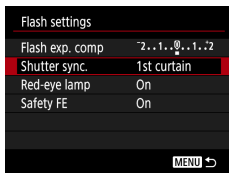

### 1 [Shutter sync.]

1st curtain	The flash fires immediately after the shutter opens.
2nd curtain	The flash fires immediately before the shutter closes.



## Reducing Red-Eye

To help prevent red-eye, the camera can illuminate the red-eye reduction lamp before firing the flash in low-light shots.

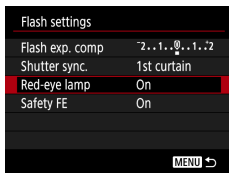

### 1 [Red-eye lamp]



## Configuring Safety FE

To ensure suitable exposure in flash photography under unfavorable exposure conditions, the camera can automatically adjust the shutter speed, aperture value, and ISO speed.

Flash settings	
Flash exp. comp	2..1..0..1..2
Shutter sync.	1st curtain
Red-eye lamp	On
Safety FE	On

MENU ↩

### 1 [Safety FE]





# Continuous Shooting

Hold the shutter button all the way down to shoot continuously.

AUTO



1  button →  OFF →  or 

## 2 Shoot.

- The camera shoots continuously as long as you hold the shutter button all the way down.







## Using the Self-Timer

With the self-timer, you can include yourself in group photos or other timed shots. The camera will shoot about 10 seconds after you press the shutter button all the way down. By setting the timer to two seconds, you can also avoid any camera shake from pressing the shutter button.

AUTO



1  button → [ ]  → [] or []

### 2 Shoot.

- Focus on the subject and press the shutter button all the way down.
- Once you start the self-timer, the lamp will blink and the camera will play a self-timer sound.





## Adding a Date Stamp

The camera can add the shooting date to images, in the lower-right corner. However, note that date stamps cannot be edited or removed, so confirm beforehand that the date and time are correct (📖27).

AUTO

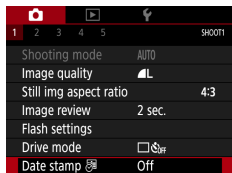

1 [Date stamp ] → [Date] or [Date & time]

2 Shoot.

- As you take shots, the camera adds the shooting date or time to the lower-right corner of images.



94





## Adjusting Image Brightness (Exposure Compensation)

Standard exposure set by the camera for stills or movies can be adjusted in 1/3-stop increments in a range of  $\pm 3$  stops.



Set toward -



Set toward +

P



### 1 Set the exposure compensation.

- ▲ button →  dial

### 2 Compose the shot and shoot.



95





## Auto Exposure Bracketing (AEB Shooting)

Three images are captured at different exposure levels. Bracketing width is adjustable in 1/3-stop increments in a range of  $\pm 2$  stops, centered on the exposure compensation level.



Underexposure



Overexposure

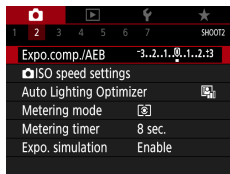

### 1 [Expo.comp./AEB]

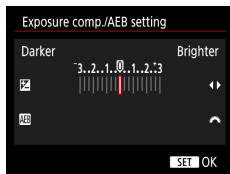

### 2 Configure the settings.

- Exposure compensation: ◀▶ buttons
- AEB:  dial





### 3 Shoot.

- Over a series of three images captured as you press the shutter button, exposure is adjusted relative to the level set in step 2, from standard exposure to underexposure to overexposure.
- When  [Drive mode] is set to [High speed continuous] or [Low speed continuous], three images are captured each time you hold the shutter button all the way down, before the camera stops shooting.





## Changing the ISO Speed

Set the ISO speed to [AUTO] for automatic adjustment to suit the shooting mode and conditions. Otherwise, set a higher ISO speed for higher sensitivity, or a lower value for lower sensitivity.

P

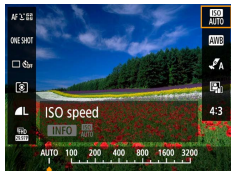

- 1 button → → choose an option



## Adjusting ISO Auto Settings

You can limit the maximum ISO speed set automatically.

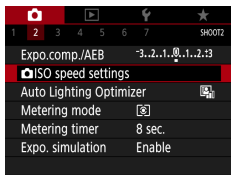

- 1 [Camera ISO speed settings] → [Max for Auto]



98





## Auto Correction of Brightness and Contrast (Auto Lighting Optimizer)

Correct brightness and contrast automatically to avoid images that are too dark or have too little or too much contrast.



 Low



 High

P

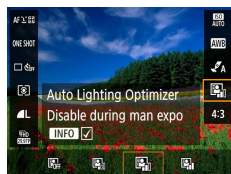

- 1  button →  → choose an option



99





## Changing the Metering Method

Adjust the metering method (how brightness is measured) to suit shooting conditions.

P



1 button → → choose an option

Evaluative metering	For typical shooting conditions, including backlit shots. Automatically adjusts exposure to match the shooting conditions.
Spot metering	Metering restricted to within the  (Spot AE Point frame), displayed in the center of the screen.
Center-weighted average	Determines the average brightness of light across the entire image area, calculated by treating brightness in the central area as more important.



100







## Setting the Metering Timer

You can adjust the metering timer period, which determines how long exposure is displayed (AE lock).

P

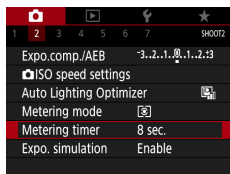

### 1 [Metering timer]



101





## Configuring Exposure Simulation

With exposure simulation, image brightness more closely matches the actual brightness (exposure) of your shots. Image brightness changes in response to exposure compensation. Do not use this feature if you prefer image display at standard brightness, which is usually easier to see.

P

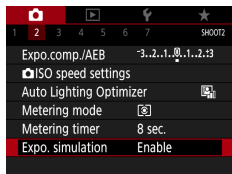

### 1 [Expo. simulation]





## Capturing Natural Colors (White Balance)

By adjusting white balance (WB), you can make image colors look more natural for the scene you are shooting.



Daylight



Cloudy



Tungsten light

P



- 1 button → **[AWB]** → choose an option

### To adjust white balance

- INFO button → ▲/▼/◀/▶ buttons

### To set white balance bracketing

- INFO button → dial
- Three images are captured per shot, each with different color tones.



103





## Custom White Balance

For image colors that look natural under the light in your shot, adjust white balance to suit the light source where you are shooting. Set the white balance under the same light source that will illuminate your shot.



### 1 Shoot a white object.

- Focus and shoot with a plain white object filling the screen.
- Press the  button.

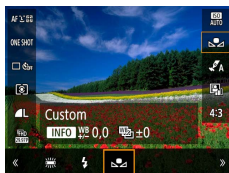

### 2 [AWB] →

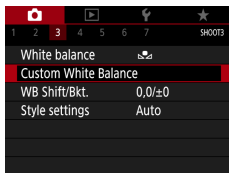

### 3 [Custom White Balance]



### 4 Load the white data.

- Select your image from step 1 →  button → [OK]
- Use the **MENU** button to return to the shooting screen.







## Customizing Colors (Style Settings)

Choose color settings that express scenes or subjects well.

P



1  button → [A] → choose an option

To adjust contrast, saturation, or other settings

• [S] → INFO button → choose an option → ◀/▶ buttons



105





## Shooting with Servo AF

Focus and exposure are maintained where the blue AF point is displayed while you press the shutter button halfway. This helps you avoid missing shots of subjects in motion.

P



1  button → [ONE SHOT] → [SERVO]

2 Press the shutter button halfway to focus.

3 Press all the way down to shoot.



106





## Choosing the AF Method

Choose a method of auto focusing (AF) for the subject and scene you are shooting.

P

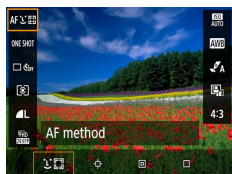

- 1 button → [AF ] → choose an option

+Tracking	Shoot with the focus on the face of the main subject, as determined by the camera. Subjects are tracked within a certain range.
Tracking AF	Shoot after choosing a subject to focus on.
Spot AF	Autofocus with an AF point smaller than for 1-point AF.
1-point AF	The camera focuses using a single AF point. Effective for reliable focusing.



## Choosing Subjects to Focus On (Tracking AF)

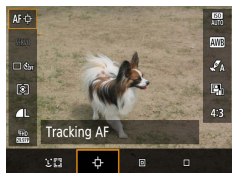

- 1 []
  - [] is displayed in the center of the screen.



107



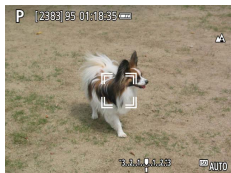

## 2 Choose a subject to focus on.

- Aim the camera so that [□] is on the desired subject, and then press the [ ] button.
- When the subject is detected, [ ] is displayed. Even if the subject moves, the camera will continue to track the subject within a certain range.
- If no subject is detected, [□] is displayed.
- To cancel subject selection, press the [ ] button again.

## 3 Shoot.

- Press the shutter button halfway. [ ] changes to a blue [ ], which follows the subject as the camera continues to adjust the focus and exposure (Servo AF) (106).
- Press the shutter button all the way down to shoot.
- Even after your shot, [ ] is still displayed and the camera continues to track the subject.







## Moving the AF Point

The AF point can be moved when the AF method is [1-point AF] or [Spot AF].



**1** Press the  button.

**2** Move the AF point.

- Move: ▲/▼/◀/▶ buttons or  dial
- Center (original position): **INFO** button





## Changing the Focus Setting

Continuous AF constantly focuses on subjects the camera is aimed at, even when the shutter button is not pressed. This setting can be changed to limit autofocusing to the moment you press the shutter button halfway.

P

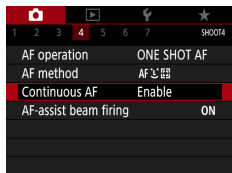

### 1 [Continuous AF]

Enable	Helps avoid missing sudden photo opportunities, because the camera constantly focuses on subjects until you press the shutter button halfway.
Disable	Conserves battery power, because the camera does not focus constantly. However, this may delay focusing.





## Configuring the AF-Assist Beam

The lamp lights up to help you focus when you press the shutter button halfway in low-light conditions. You can configure whether the beam is activated.

AUTO

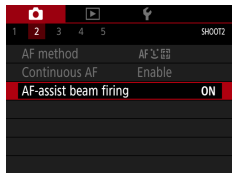

### 1 [AF-assist beam firing]



111





## Changing the IS Mode Settings

Image stabilization is adjustable.

P

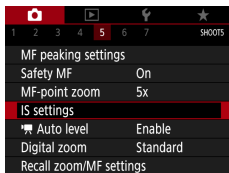

1 [IS settings] → [IS mode]

Off	Deactivates image stabilization.
On	Optimal image stabilization for the shooting conditions is automatically applied.
Shoot only	Image stabilization is active only at the moment of shooting.



## Correcting Severe Camera Shake

Counteract severe camera shake, such as when recording movies while moving. The portion of images displayed changes more than for [Standard], and subjects are further enlarged.

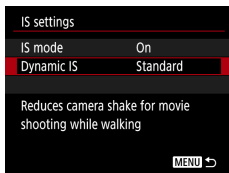

1 [Dynamic IS] → [High]



112





## Using Auto Level

Auto leveling helps keep movies straight as you record them. Once recording begins, the display area may narrow, and subjects may be enlarged.

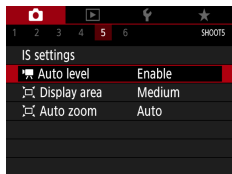

### 1 [Auto level]







## Using Digital Tele-Converter

The focal length of the lens can be increased by approximately 1.6x or 2.0x. This can reduce camera shake because the shutter speed is faster than it would be if you zoomed (including using digital zoom) in to the same zoom factor.

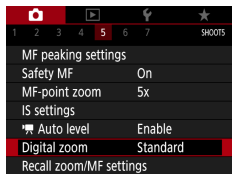
P



- 1  [Digital zoom] → [1.6x] or [2.0x]
  - The view is enlarged and the zoom factor is displayed.





## Storing the Zoom or MF Position

The zoom position and manual focal position can be stored by the camera. Shooting resumes from these positions the next time the camera starts up.

P

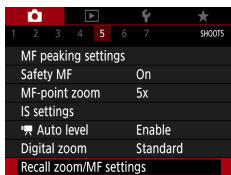

1  [Recall zoom/MF settings]

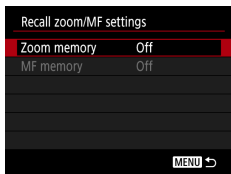

2 Configure the settings.



115





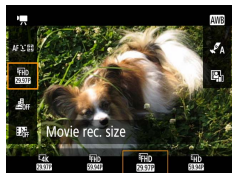

## Changing Movie Recording Size

Adjust the movie recording size. The frame rate indicates how many frames are recorded per second, and available options depend on the NTSC or PAL setting.



1  button →  → choose an option



116







# Configuring Sound Recording Settings

Several sound recording settings are available.

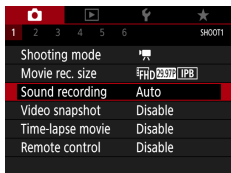

## 1 [Sound recording]

## Adjusting the Recording Volume

When set to [Auto], the recording level (volume) is automatically adjusted during recording. If you prefer to adjust the level manually to suit the scene, change it to [Manual].

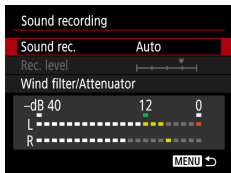

## 1 [Sound rec.] → [Manual]

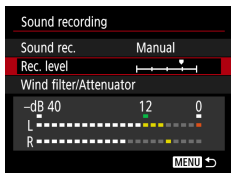

## 2 [Rec. level]

- button → buttons





## Wind Filter

Noise from windy recording sites can be reduced with the wind filter. If there is no wind, recordings may sound unnatural when this option is used. In this case, set [Wind filter] to [Disable].

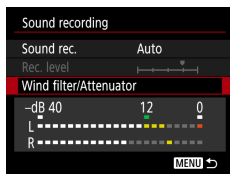

- 1 [Wind filter/Attenuator] → [Wind filter]

## Attenuator

The attenuator can prevent audio distortion at noisy recording sites. Three options are available: [Enable], [Disable], or [Auto] for automatic activation/deactivation as needed.

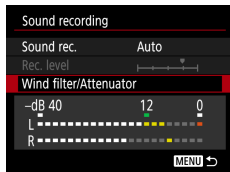

- 1 [Wind filter/Attenuator] → [Attenuator]





## Configuring Movie Servo AF

Specify whether to keep subjects in focus when recording movies.

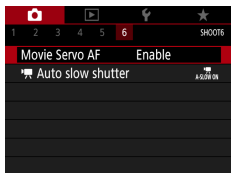

### 1 [Movie Servo AF]

Enable	Keeps subjects in focus, even when the shutter button is not pressed halfway.
Disable	Focus remains constant as movies are recorded.





## Using Auto Slow Shutter

Specify whether to reduce the shutter speed automatically under low light when recording [FHD 59.94P], [FHD 59.94P], [FHD 50.00P], or [FHD 50.00P] movies.

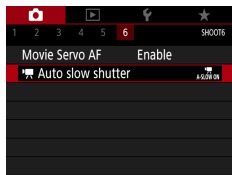

### 1 [Auto slow shutter]

Enable	Enables you to record movies that are brighter and less affected by image noise by automatically reducing the shutter speed to 1/30 sec. under low light.
Disable	Enables you to record movies with smoother, more natural movement, less affected by subject shake than when set to [Enable]. Note that under low light, movies may be darker than when set to [Enable].



120







## Miniature Model Effect in Movies (Miniature Effect Movie)

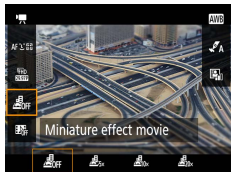

 Miniature effect movie

Creates the effect of a miniature model in movies, by blurring image areas outside a selected area.



- 1  button → [ OFF] → choose an option

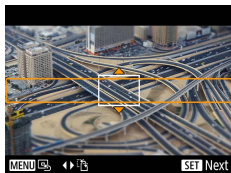

- 2 Set the area to keep in focus (scene frame).

- INFO button → ▲/▼ buttons to move the frame →  button

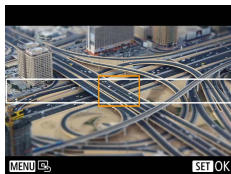

- 3 Set the position in focus (AF point).

- ▲/▼/◀/▶ buttons to move the AF point →  button

- 4 Start recording.

- Press the shutter button halfway to focus, and then press the movie recording button.



121





# Recording Video Snapshots

Record a series of 4, 6, or 8 sec. video snapshots, and the camera will combine them to create a video snapshot album that shows these highlights of your trip or event.



Video snapshot	
Video snapshot	Enable
Album settings	New album
Playback time	4 sec.
Playback effect	1x speed
Show confirm msg	Enable
Time required	4 sec.
MENU ↶	

**1**  [Video snapshot] → [Video snapshot] → [Enable]

**2** Configure the settings.

Playback time	Choose the video snapshot playback time.
Playback effect	Choose the video snapshot playback effect.
Show confirm msg	Choose whether to display a confirmation message after each video snapshot is recorded.

- The time required to record a video snapshot ([Time required]) is displayed, based on [Playback time] and [Playback effect].
- After your first video snapshot is recorded, in [Album settings], you can choose which album to save your next video snapshot to.



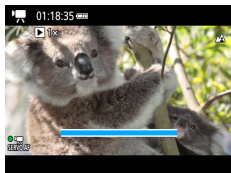

### 3 Start recording.

- Press the **MENU** button to return to the shooting screen, and then press the movie recording button.
- A bar showing the elapsed time is displayed, and recording stops automatically when finished.

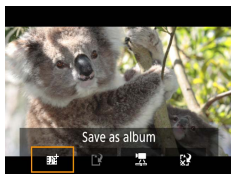

### 4 Save to an album.

- This message is not displayed if you set [Show confirm msg] to [Disable] in step 2, and the video snapshot is automatically saved to the album you selected in [Album settings] in step 2.
- Repeat steps 3–4 as needed.

### 5 Stop recording video snapshots.

-  button → [MENU] → [Off]



123





# Recording Time-Lapse Movies

Time-lapse movies combine images that are shot automatically at a specified interval. Any gradual changes of the subject (such as changes in a landscape) are played back in fast motion.

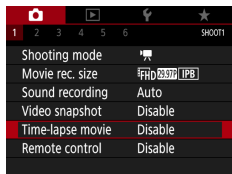

1 📷 [Time-lapse movie] → [Time-lapse] → [Scene \*]

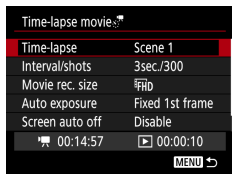

2 Configure the settings.

- Set the shooting interval and other settings.

3 Start recording.

- Use the **MENU** button to return to the shooting screen.
- Press the shutter button halfway to focus, and then press the movie recording button.







## Configuring Information Display for HDMI Output

Specify whether to show on-screen information over images in HDMI output.

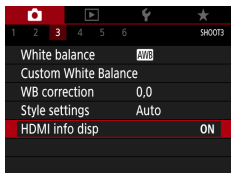

### 1 [HDMI info disp]

With info	Information display is included in HDMI output as movies are recorded. No image is shown on the camera. Movies can be recorded on the camera.
Clean / 4K output	HDMI output consists only of 4K content, without information display. On the camera, information display is shown over images. Movies cannot be recorded on the camera.
Clean / FHD output	HDMI output consists only of Full HD content, without information display. On the camera, information display is shown over images. Movies cannot be recorded on the camera.





## Setting the Type of Digest Movie

Specify whether digest movies recorded in  mode include stills.

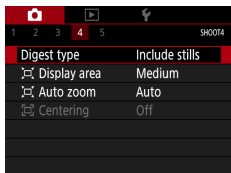

### 1 [Digest type]

Include stills	Digest movies include both stills and clips.
No stills	Digest movies include only clips. Stills are not recorded in the movies.



# Playback

Enjoy browsing through your shots, and find and edit images in several ways.

- To prepare the camera for these operations, press the  button to switch to playback.



# Viewing

After shooting stills or movies, you can view them on the screen as follows.

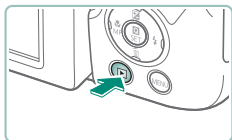

1 Press the  button.



2 Choose images.



- Movies are labeled with **[SET]** .

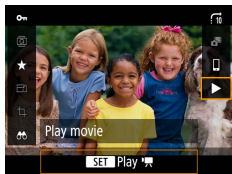

## Playing movies

-  button (twice)
- Press the / buttons to adjust the volume.



128





# Magnifying Images

Images you play back can be magnified.





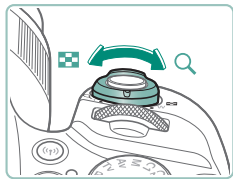

**1** Choose images.

**2** Magnify or reduce images.

- Magnify: Zoom lever toward 
- Reduce: Zoom lever toward 



- Move the display position:    



## Viewing Digest Movies

A short movie of scenes when you shoot in  mode is created automatically. Playing a digest movie shows the scenes captured that day.



1 Choose **[SET ** images.

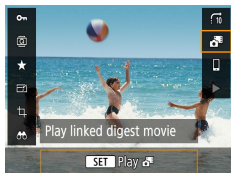

2  button → 

- The digest movie recorded automatically on the day of still shooting is played back from the beginning.



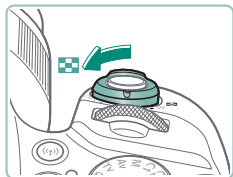

## Finding Images in an Index

By displaying multiple images in an index, you can quickly find the images you are looking for.



### 1 Move the zoom lever toward .

- Display more images: Zoom lever toward 
- Display fewer images: Zoom lever toward 

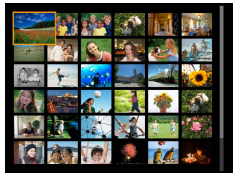

### 2 Find the images.

- ▲/▼/◀/▶ buttons or  dial

### 3 Choose an image.

-  button



# Editing Movies

## ● Removing the Beginning/End of Movies

You can remove unneeded portions from the beginning and end of movies (except digest movies (📖54) and video snapshots (📖122)).

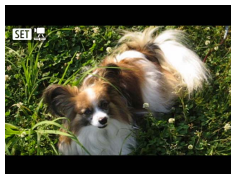

**1** Choose a [SET] 📺 movie.

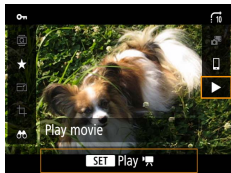

**2** ⏸ button → ▶]

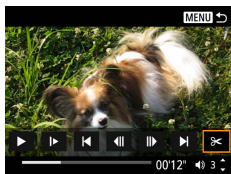

**3** Choose [⏮].

- During playback, press the ⏸ button to choose [⏮].
- The movie editing panel and editing bar are displayed.







#### 4 Specify portions to cut.

- Choose [V] or [W].
- To view the portions you can cut (identified by [S] on the screen), press the ◀/▶ buttons to move [L] or [R]. At the position to cut, press the [SET] button.

#### 5 Review the edited movie.

- Playback: ▶
- Cancel editing: MENU button

#### 6 Save the movie.

- [L] → [New file]
- Save a compressed version: [W] → [OK]

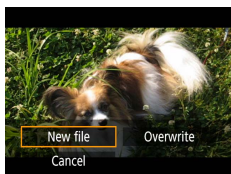



## ● Extracting Frames of 4K Movies as Stills

Frames of your choice in [4K 29.97P] or [4K 25.00P] movies can be saved as stills.

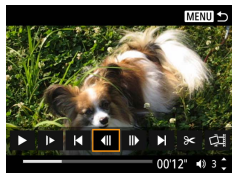

### 1 Choose a frame to extract.

- During playback, press the [⏸] button, and then use [⏮] or [⏭] to choose a frame.

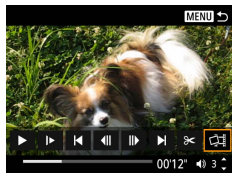

### 2 Save the image.

- [📷] → [OK]





## Editing Digest Movies

Individual chapters (clips) (📖54) recorded in **[SET]** mode can be erased. Be careful when erasing clips, because they cannot be recovered.



**1** Choose **[SET]** images.

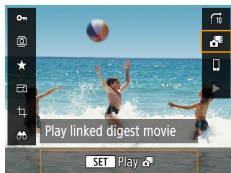

**2** **[SET]** button → **[📷]**

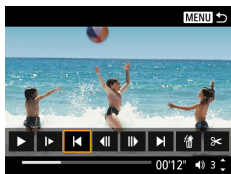

**3** Choose a clip.

- During playback, press the **[SET]** button, and then use **[⏪]** or **[⏩]** to choose a clip.

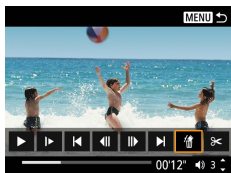

**4** Erase the selected clip.

- **[🗑️]** → [OK]



135



## Protecting Images

Important images can be selected and protected to prevent accidental erasure from the camera.

Protected images are labeled with a  icon.

- 1 Choose an image.
- 2  button →  → [Enable]

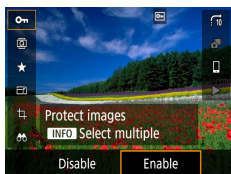

## Protecting Multiple Images

You can choose multiple images to protect at once.



- 1  [Protect images]

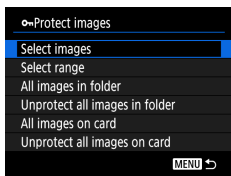

- 2 Choose images.



### Selecting images individually

- [Select images] → choose an image →  
 button → **MENU** button

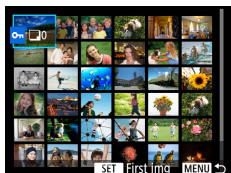

### Selecting a range

- [Select range] → choose the first image  
 →  button → choose the last image →  
 button → **MENU** button

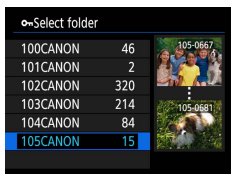

### Selecting all images in a folder

- [All images in folder] → choose a folder  
 → [OK]

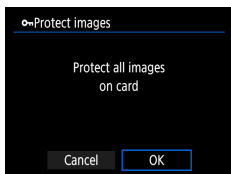

### Selecting all images on a card



- [All images on card] → [OK]

## Rotating Images



Change the orientation of images and save them.

**1** Choose an image.

**2**  button →  → choose an option

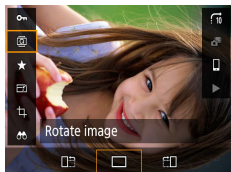



## Erasing Images

Unneeded images can be erased. Be careful when erasing images, because they cannot be recovered.

**1** Choose an image.

**2** Press the ▼ button.

- Choose the erasure option →  button



## Erasing Multiple Images at Once

You can choose multiple images to erase at once.

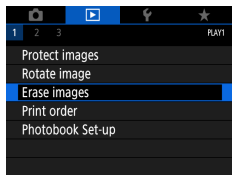

**1**  [Erase images]

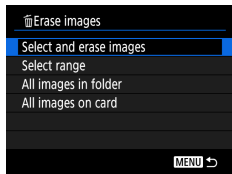

**2** Choose images.





### Selecting images individually

- [Select and erase images] → choose an image → button
- The image is labeled with [✓].
- **MENU** button → [OK]

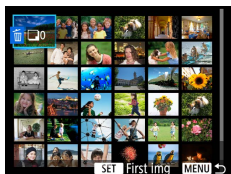

### Selecting a range

- [Select range] → choose the first image → button → choose the last image → button → **MENU** button → [OK]

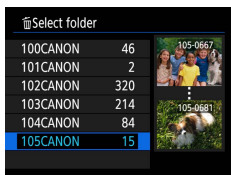

### Selecting all images in a folder

- [All images in folder] → choose a folder → [OK]

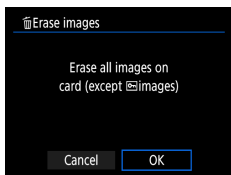

### Selecting all images on a card

- [All images on card] → [OK]





## Adding Images to Print Orders (DPOF)

Set up batch printing (up to 400 images) or ordering prints from a photo development service (up to 998 images) by choosing the images on a memory card and the number of copies. The printing information you prepare this way will conform to DPOF (Digital Print Order Format) standards.

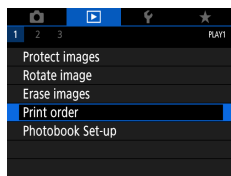

### 1 ▶ [Print order]

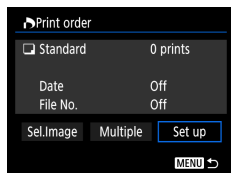

### 2 Add images to the print list.

#### Choosing images.

- [Sel. Image] or [Multiple] → choose images and the number of copies
- Press the **MENU** button to return to the printing screen.

#### Other settings

- [Set up] → choose an item → choose an option
- Press the **MENU** button to return to the printing screen.



## ● Printing Images Added to the Print Order (DPOF)

### 1 Connect the camera to a PictBridge-compatible printer.

- The playback screen is displayed.
-  button → [Print order]

### 2 Print the images.

- [Print] → [OK]

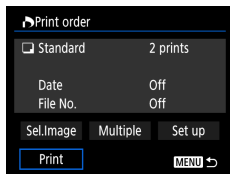

# Adding Images to a Photobook

Photobooks can be set up by choosing up to 998 images on a memory card.

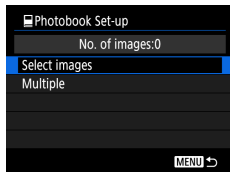
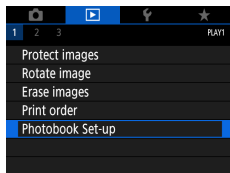

## 1 ▶ [Photobook Set-up]

## 2 Choose images.

### Choosing images individually

- [Select images] → choose an image →  button → **MENU** button

### Selecting a range

- [Multiple] → [Select range] → choose the first image →  button → choose the last image →  button → **MENU** button

### Selecting all images in a folder

- [Multiple] → [All images in folder] → choose a folder → [OK]

### Selecting all images on a card

- [Multiple] → [All images on card] → [OK]





## Correcting Red-Eye



Automatically corrects images affected by red-eye. You can save the corrected image as a separate file.

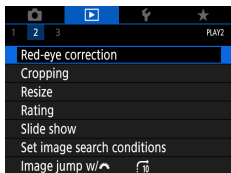

**1**  [Red-eye correction]

**2** Choose an image.

**3** Press the  button.

**4** Save the image.





# Cropping



















You can specify a portion of an image to save as a separate image file.



1  button → [ ]





2 Adjust the cropping area.

- Reduce the frame: Zoom lever toward 
- Enlarge the frame: Zoom lever toward 
- Move the frame:     buttons
- Straighten the image:  dial →  →  button →  dial
- Change the aspect ratio:  dial →  →  button
- Preview the image:  dial →  →  button





### 3 Save the image.

-  dial →  → [OK]







## Resizing Images

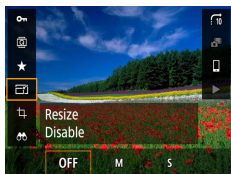

Save a smaller version of an image, with fewer pixels.



**1**  button →  → choose an option

**2** Save the image.







# Rating Images

Organize images by rating them on a scale of 1 – 5.

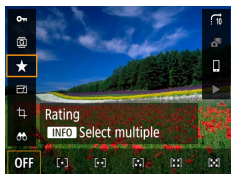
- 1 Choose an image.
- 2  button → [★] → choose an option

- Choose multiple images: **INFO** button → choose an item



- [Select range]: Choose the first image →  button → choose the last image →  button → **MENU** button →  dial to set the rating → [OK]

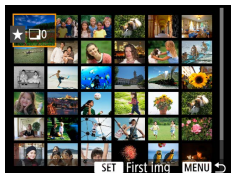

- [All images on card]:  dial to set the rating → [OK]

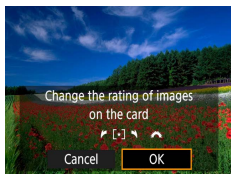





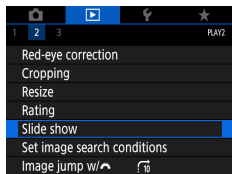

## Viewing Slideshows

Automatically play back images from a memory card.



1  [Slide show] → [Start]



149



# Finding Images Matching Specified Conditions

Find images quickly on a memory card full of images by filtering image display according to your specified conditions.

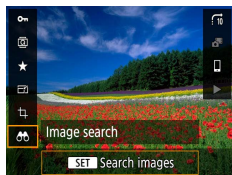

1 button →

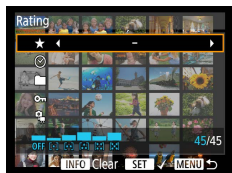

2 Specify conditions.

- Item: ▲/▼ buttons
- Option: ◀/▶ buttons



3 Complete the setting.

- MENU button → [OK]
- Matching images are displayed in yellow frames.

### To cancel filtered display



- button → → INFO button → MENU button → [OK]

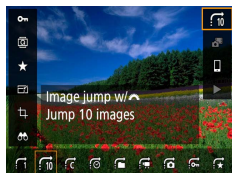

## Finding Images with the Main Dial

Use the  dial to find and jump between images quickly according to your specified conditions.



**1**  button → [] → choose an option



**2** Find the images.

●  dial

# Combining Video Snapshots

Combine video snapshots to create a new movie (album).

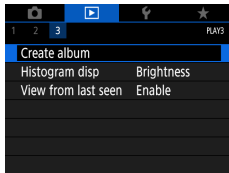

## 1 [Create album]

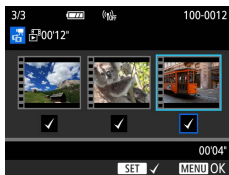

## 2 Specify video snapshots.

- Choose a movie (an existing album) →  button → **MENU** button → [OK]

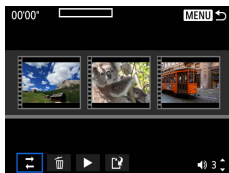

## 3 Edit the album.

- Video snapshots in the movie selected in step 2 are displayed.
- Choose an item in the editing menu at the bottom and press the  button.
- Along the top of the screen, choose video snapshots to edit, and edit them as needed.



Rearrange video snapshots	Rearrange video snapshots. Choose a video snapshot to move and press the  button. To move it, use the   buttons.
Remove video snapshot	Choose video snapshots to exclude from the new album. Video snapshots labeled with a  icon are not included in the new album, but they are not deleted from the original album.
Play video snapshot	Play the selected video snapshot.
Finish editing	Exit album editing.

#### 4 Exit editing.

- Press the **MENU** button to return to the editing menu.
- Choose to exit editing.

#### 5 Save the album.

- Choose [Save].
- To add background music, choose [Background music].
- Choose [Preview] to preview the album you edited.





## Starting Playback from the Last Image Displayed

You can specify whether to show the last image displayed when you switch to the playback screen.

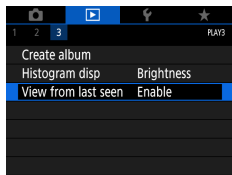

1  [View from last seen]

Enable	The last image displayed on the playback screen is displayed.
Disable	The most recent image is displayed.



# Wireless Features

Send images wirelessly to a variety of compatible devices, or share them via Web services.



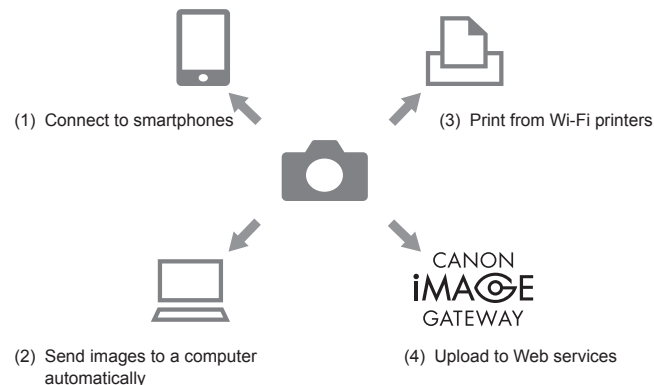

Before using wireless features, be sure to read “Precautions for Wireless Features” (📖278).

## Available Wireless Features



- (1) Connect to smartphones (📖158, 📖165)  
Control the camera remotely and browse images on the camera over a Wi-Fi connection by using the dedicated Camera Connect app on smartphones or tablets.  
You can also geotag images and use other features when connected by Bluetooth<sup>®\*</sup>.  
For convenience in this guide, smartphones, tablets, and other compatible devices are collectively referred to as “smartphones”.  
\* Bluetooth low energy technology (hereafter referred to as “Bluetooth”)
- (2) Send images to a computer automatically (📖171)  
With Image Transfer Utility 2, camera images can be automatically sent to a computer connected via Wi-Fi.



- (3)  Print from Wi-Fi printers  167  
Print images over a Wi-Fi connection from printers compatible with PictBridge (wireless LAN) technology.
- (4)  Upload to Web services  174  
Share images with friends or family on social media or the CANON iMAGE GATEWAY online photo service for Canon customers after you complete member registration (free of charge).

## Saving Camera Images to a Smartphone

Images on the camera can be saved to a Bluetooth enabled smartphone connected via Wi-Fi.

Prepare the smartphone as follows.

- The free dedicated Camera Connect app must be installed on the smartphone.
- For details on this app (supported smartphones and included functions), refer to the Canon website.
- Camera Connect can be installed from Google Play or the App Store. You can also access Google Play or the App Store from a QR code that you can display on the camera when registering the smartphone on the camera.
- Use the latest version of the smartphone OS.
- Activate Bluetooth and Wi-Fi on the smartphone. Note that pairing with the camera is not possible from the smartphone's Bluetooth settings screen.

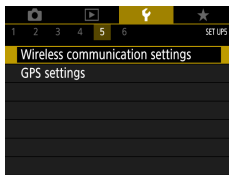

### 1 [Wireless communication settings]

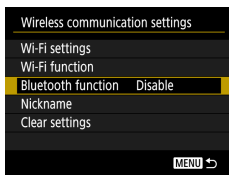

### 2 [Bluetooth function]

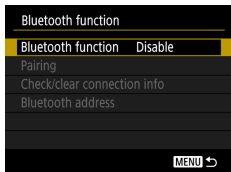

**3** [Bluetooth function] →  
[Smartphone]

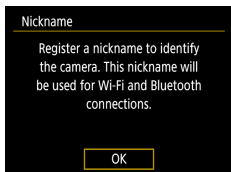

**4** Press the button.

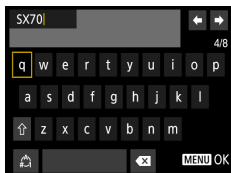

**5** Enter a nickname and press the  
MENU button.

- To use the nickname displayed, press the MENU button.

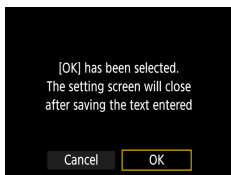

**6** [OK]

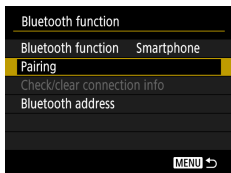

**7** [Pairing]

Install Camera Connect on the smartphone. Display QR code for download site?

Do not display

Android

iOS

Pairing

Pairing in progress.  
Use Canon app/software on the smartphone to finish pairing.

Cancel



Pairing

Connect to this smartphone:  
XXXXX

Cancel

OK

Pairing

Paired with:  
XXXXX

OK

## 8 [Do not display]

## 9 Start Camera Connect on the smartphone.

## 10 Touch the nickname of the camera for pairing.

## 11 Touch [Pair] (iOS only).

## 12 On the camera, choose [OK].

## 13 Press the button.

- Pairing is now complete, and the camera is connected to the smartphone via Bluetooth.



#### 14 In Camera Connect, touch [Images on camera].

- A Wi-Fi connection is established automatically.
- In iOS, choose [Join] when a message is displayed to confirm camera connection.

#### 15 Confirm that the devices are connected via Wi-Fi.

- Images on the camera are listed on the smartphone.
- [Wi-Fi on] is displayed on the camera.



#### 16 Save images on the camera to the smartphone.

- Choose listed camera images and save them to the smartphone.



## Connecting to Smartphones via Wi-Fi with the Wi-Fi Button

You can also establish a Wi-Fi connection with smartphones from the button.

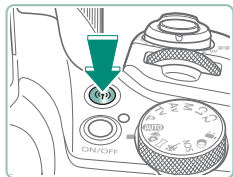

#### 1 Press the button.

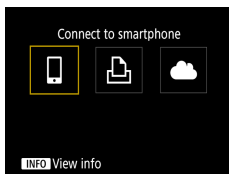

## 2 Register a nickname.

- If the [Nickname] screen is displayed, register a nickname (📖 158).

## 3

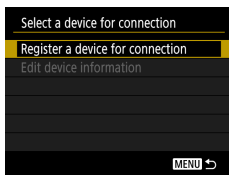

## 4 [Register a device for connection]

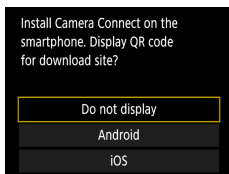

## 5 [Do not display]

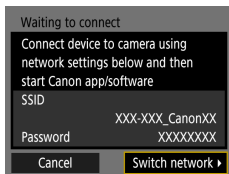

## 6 Check the SSID and password.



## 7 Connect the smartphone to the camera.

- In the smartphone's Wi-Fi setting menu, choose the SSID (network name) displayed on the camera to establish a connection.
- In the password field on the smartphone, enter the password displayed on the camera.

## 8 Start Camera Connect on the smartphone.

## 9 Select the camera to connect to.

- In the [Cameras] list in Camera Connect, touch the camera to connect to via Wi-Fi.

## 10 Establish a Wi-Fi connection.

- [OK] → button
- Wi-Fi on] is displayed on the camera.
- The main Camera Connect screen is displayed on the smartphone.
- The devices are now connected via Wi-Fi.

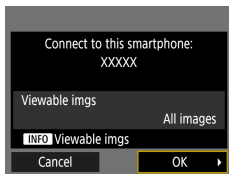

## Restricting Image Viewing

Restrict the images that can be sent to the smartphone or browsed from the smartphone.



- 1** While disconnected from Wi-Fi, press the button.
- 2**
- 3** Choose [Edit device information], and then choose the smartphone.
- 4** Choose [Viewable imgs], and then specify which images can be viewed.





## Features Used with Smartphones

The features described below are available over a wireless connection with smartphones.

Pair the camera with a smartphone via Bluetooth as described in steps 1–13 of “Saving Camera Images to a Smartphone” (📖 158), and connect via Wi-Fi as described in steps 1–15.

### ● Sending Images to a Smartphone Automatically as You Shoot

Your shots can be automatically sent to a smartphone connected via Wi-Fi.



- 1 [Wireless communication settings] → [Wi-Fi settings] → [Send to smartphone after shot]
- 2 [Auto send] → [Enable]
  - Choose a size in [Size to send].
- 3 Shoot.
  - Your shots are sent to the smartphone.

### ● Shooting Remotely as You View a Live Image on the Smartphone

As you view a live image on a smartphone connected via Wi-Fi, you can shoot remotely.



- 1 Start Camera Connect.
- 2 Touch [Remote live view shooting].



## Controlling the Camera from a Smartphone

You can control the camera by using a smartphone paired via Bluetooth as a remote control.



### 1 Start Camera Connect.

- If connected via Wi-Fi, end the connection.

### 2 Touch [Bluetooth remote controller].

## Geotagging Images as You Shoot

Your shots can be geotagged using GPS information (such as latitude, longitude, and elevation) from a smartphone paired via Bluetooth. On the playback screen, you can check the location information added to your shots. On the smartphone, activate location services.



### 1 Start Camera Connect.

- If connected via Wi-Fi, end the connection.



### 2 ☰ [GPS settings]

### 3 [GPS via mobile] → [Enable]

### 4 Shoot.

- Before shooting, confirm that [Bluetooth] and [GPS] icons are shown on the camera.
- Your shots are now geotagged.
- From now on, shots you take with Camera Connect running will be geotagged.



## Connecting to Printers via Wi-Fi

Images on the camera can be printed on a printer connected to the camera via Wi-Fi.

**1** Press the button.

**2**



**3** [Register a device for connection]



**4** Check the SSID and password.

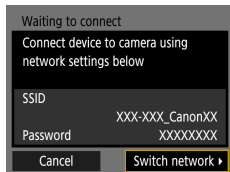



## 5 Connect to the camera from the printer.

- In the printer's Wi-Fi setting menu, choose the SSID (network name) displayed on the camera to establish a connection.
- In the password field on the printer, enter the password displayed on the camera.

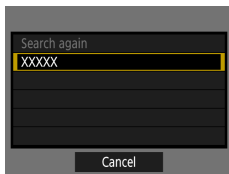

## 6 Choose the printer.

- Choose the printer to connect to via Wi-Fi and press the button.
- Images on the memory card are displayed after the devices are connected via Wi-Fi.

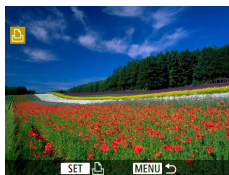

## 7 Choose an image to print.

- Choose an image and press the button.
- Select or specify the items displayed, and then print.

## Establishing a Connection via an Access Point

The camera can connect to an access point that a printer is connected to, to print via the access point.

Connect the devices near the access point, because you will need to press the WPS button.

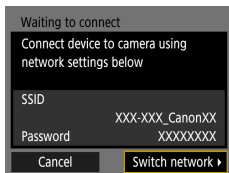

- 1 In step 4 of “Connecting to Printers via Wi-Fi” (📖 167), choose [Switch network].

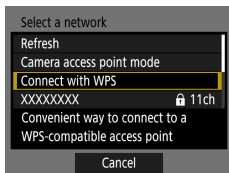

- 2 [Connect with WPS]

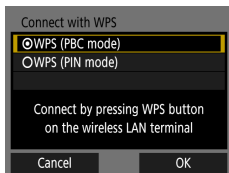

- 3 [WPS (PBC mode)] → [OK]



- 4 Press the WPS button on the access point.

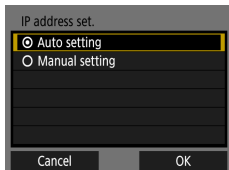

## 5 [Auto setting] → [OK]

- The camera will connect to the access point.

## 6 Go to step 6 of “Connecting to Printers via Wi-Fi” (📖167).



## Sending Images to a Computer Automatically

Images on the camera can be automatically sent to a computer connected to an access point (also set up for camera Wi-Fi connections) when the camera is within range, as when you bring the camera home after shooting.

### Connecting via Wi-Fi



#### 1 Connect the computer to the access point.

- Install Image Transfer Utility 2 on the computer.

#### 2 Start Image Transfer Utility 2.

#### 3 In Image Transfer Utility 2, access the pairing settings screen.

- The screen to set up pairing is shown when you follow the instructions displayed the first time Image Transfer Utility 2 starts up.

#### 4 [Wireless communication settings] → [Wi-Fi settings]

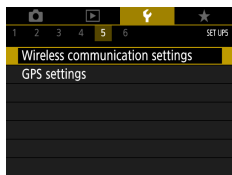

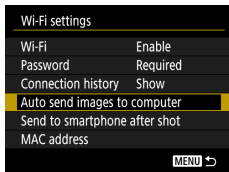

**5** [Auto send images to computer] → [Auto send] → [Enable]

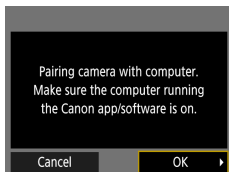

**6** [OK]

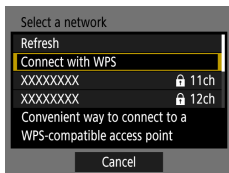

**7** [Connect with WPS] → [WPS (PBC mode)] → [OK]



**8** Press the WPS button.

- Press the WPS button on the access point to allow the camera to connect.

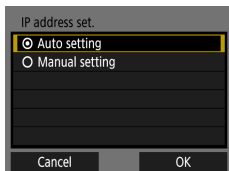

**9** [Auto setting] → [OK]



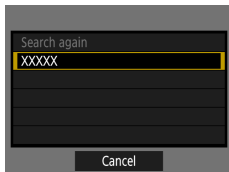

## 10 Choose a computer.

- Choose a computer for auto image transfer and press the  button.



## 11 On the computer, choose the camera for pairing.

- Camera nicknames are shown on the pairing screen in Image Transfer Utility 2.
- Choose the camera to connect to and click [Pairing] to connect the computer and camera.

### Setting Up Auto Image Transfer

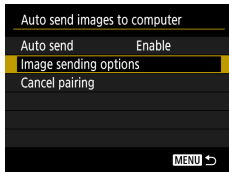

## 12 Specify the sending options.

- For [Auto send images to computer] in step 5, choose [Image sending options] and specify the transfer conditions.

## 13 Turn the camera off.

### Sending Images Automatically

- Following the sending options in step 12, images on the camera are automatically sent to the computer you are logged in to when you bring the camera within range of the access point and turn the camera on.



## Uploading Images to Web Services

### ● Registering Web Services

Use a smartphone or computer to add your Web services to the camera.

- A smartphone or computer with a browser and Internet connection is required to complete camera settings for CANON iMAGE GATEWAY and other Web services.
- Visit the CANON iMAGE GATEWAY website for details on versions of browsers (such as Internet Explorer) and settings required for CANON iMAGE GATEWAY access.
- For information on countries and regions where CANON iMAGE GATEWAY is available, visit the Canon website (<http://www.canon.com/cig/>).
- For CANON iMAGE GATEWAY instructions and setting details, refer to the help information for CANON iMAGE GATEWAY.
- To use Web services other than CANON iMAGE GATEWAY, you must have an account with them. For further details, check the websites for each Web service you want to register.
- Separate ISP connection and access point fees may apply.

## ■ Registering CANON IMAGE GATEWAY

Link the camera and CANON IMAGE GATEWAY by adding CANON IMAGE GATEWAY as a destination Web service on the camera.

Connect the devices near the access point, because you will need to press the WPS button.

Note that you will need to enter an email address used on your computer or smartphone to receive a notification message for completing linkage settings.

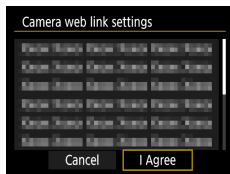
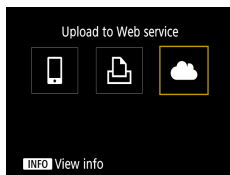

**1** Press the ((?)) button.

**2** [☁]

**3** Accept the agreement to enter an email address.

- Read the agreement displayed and choose [I Agree].

**4** Establish a connection with an access point.

- [Connect with WPS] → [WPS (PBC mode)] → [OK]
- Press the WPS button on the access point.
- Choose [Auto setting] on the camera's [IP address set.] screen.

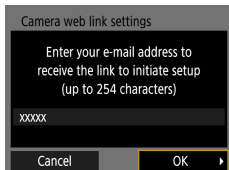

## 5 Enter your email address.

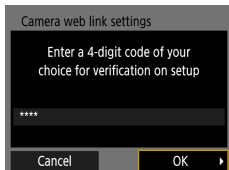

## 6 Enter a four-digit number of your choice.

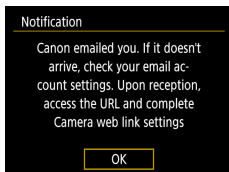

## 7 Check for the notification message.

- [OK]
- [] now changes to [].

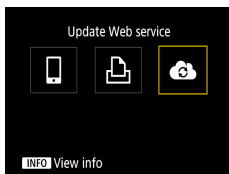

## 8 Access the page in the notification message and complete camera link settings.

- Follow the instructions to complete the settings on the camera link settings page.





## 9 Choose

- CANON iMAGE GATEWAY is now added as a destination Web service.



## ■ Registering Other Web Services

You can also add Web services besides CANON iMAGE GATEWAY to the camera.



### 1 Log in to CANON iMAGE GATEWAY and access the camera link settings page.

- <http://www.canon.com/cig/>

### 2 Follow the on-screen instructions to complete settings for Web services you want to use.

### 3 Press the button to choose .

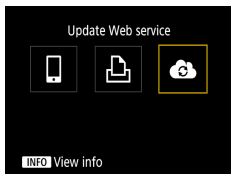

## ● Uploading Images to Web Services

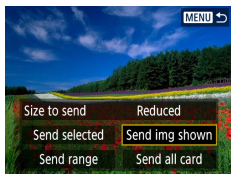

**1** Press the ((P)) button.

**2** Choose the destination.

- Choose a Web service icon.
- If a Web service offers multiple recipients or sharing options, choose an item on the screen displayed for selecting recipients.

**3** Send an image.

- Choose sending options and upload the image.
- When uploading to YouTube, read the terms of service and choose [I Agree].
- After the image is sent, [OK] is displayed. Press the ((P)) button to return to the playback screen.



## Reconnecting via Wi-Fi

Reconnecting to devices or Web services via Wi-Fi is possible once the connection settings are registered.

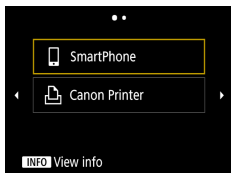

**1** Press the ((?)) button.

**2** From the past connections, choose a destination.

- If your destination is not shown, press the ◀/▶ buttons to switch to other screens.
- For Web services, the connection is now complete.

**3** Prepare the other device.

- Prepare the other device by following the instructions displayed.

## Ending Wi-Fi Connections

- 1 Press the ((⌘)) button.
- 2 [Disconnect,exit] → [OK]

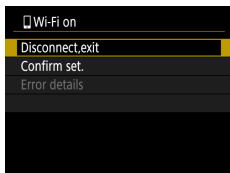



## Clearing Information of Devices Paired via Bluetooth

Before pairing with a different smartphone, clear the information about any connected smartphones.



- 1** [Wireless communication settings] → [Bluetooth function]
- 2** Choose [Check/clear connection info], and then press the **INFO** button.
- 3** Prepare the smartphone.
  - In the Bluetooth system settings, clear the registered camera information.

# Changing or Deleting Connection Settings

Connection settings saved on the camera can be changed or deleted. Before changing or deleting connection settings, end the Wi-Fi connection.

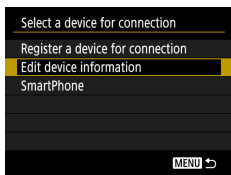
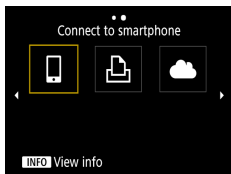
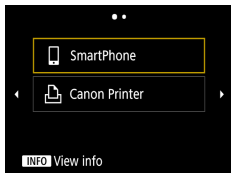

## 1 Press the ((?)) button.

## 2 Choose an item.



- On the screen at left, you can switch to other screens by pressing the ◀/▶ buttons.
- On the screen at left, choose an item with connection settings to delete or change.

## 3 Choose [Edit device information].

- On the screen displayed, choose a device with connection settings to change, and then change the nickname or other information.

# Function Settings

Make the camera easier to use by customizing or adjusting basic functions.

- These settings are configured on the  and  menu tabs. Customize commonly used functions, for greater convenience.
- These instructions apply to the camera in **P** mode.

# Selecting and Creating Folders

You can select or create folders where images are saved. New folders can be created by selecting [Create folder] on the folder selection screen.

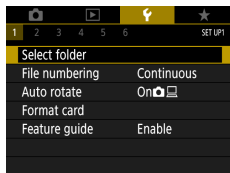

## 1 [Select folder]

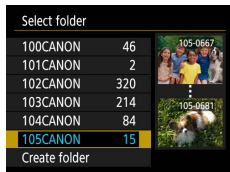

## 2 Configure the settings.

- Select folders: simply select a folder
- Create folders: [Create folder] → [OK]



## Changing File Numbering

Your shots are automatically numbered in sequential order (0001–9999) and saved in folders that store up to 9,999 images each. You can change how the camera assigns file numbers.

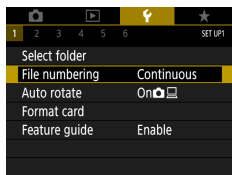

1 [File numbering] → [Numbering] or [Manual reset]

Continuous	Images are numbered consecutively (until the 9999th shot is taken/saved) even if you switch memory cards or folders.
Auto reset	Image numbering is reset to 0001 if you switch memory cards, or when a new folder is created.
Manual reset	Creates a new folder and starts numbering images from 0001.



## Configuring Auto Rotation of Vertical Images

You can change the auto rotation setting that straightens images shot in vertical orientation when they are displayed.

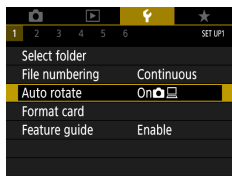

### 1 [Auto rotate]

On	Automatically rotate images during playback on both the camera and computers.
On	Automatically rotate images during playback on computers.
Off	Do not automatically rotate images.

## Formatting Memory Cards

Before using a new memory card or a card formatted in another device, you should format the card with this camera.

Low-level formatting may be helpful if the camera is not working correctly, reading/writing of images on the memory card is slower, continuous shooting is slower, or movie recording suddenly stops.

Both regular and low-level formatting erase all data on a memory card, which cannot be recovered.

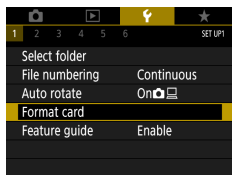

### 1 [Format card]

- Format: [OK]
- Low-level format: **INFO** button to select  → [OK]

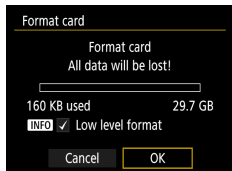
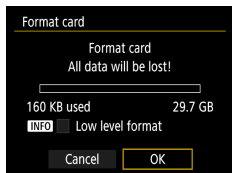

## Configuring the Feature Guide

Specify whether to display feature guidance when items are selected on the Quick Control screen.

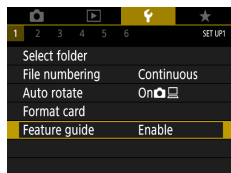

### 1 [Feature guide]



## Using Eco Mode

This function allows you to conserve battery power in shooting modes. When the camera is not in use, the screen darkens to save battery life.

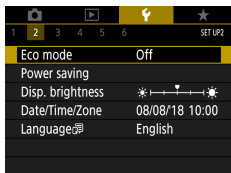

### 1 [Eco mode]

On	<p>The screen darkens when the camera is not used for approximately two seconds; approximately ten seconds after darkening, the screen turns off. The camera turns off after approximately three minutes of inactivity.</p> <p>To activate the screen and prepare for shooting when the screen is off but the lens is still out, press the shutter button halfway.</p>
Off	Do not use Eco mode.

# Adjusting Power-Saving Features

The timing of automatic deactivation of the camera, screen, and viewfinder can be adjusted in [Auto power off], [Display off], and [Viewfinder off].

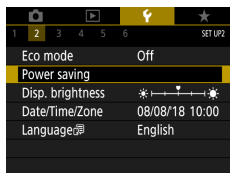

## 1 [Power saving]

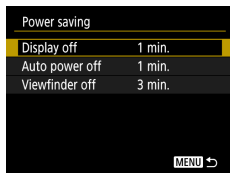

## 2 Configure the settings.



# Adjusting Screen Brightness

Viewfinder and screen brightness can be adjusted. You can adjust viewfinder brightness as you look through the viewfinder.

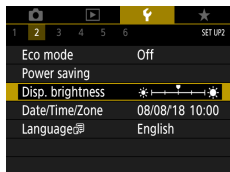

## 1 [Disp. brightness]



## 2 Configure the settings.

- buttons → button



# Adjusting the Date, Time, and Time Zone

Adjust the date and time.

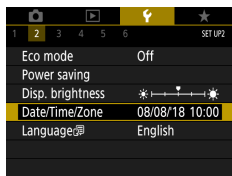

## 1 [Date/Time/Zone]

## 2 Configure the settings.

- Follow steps 2–3 in “Setting the Date, Time, Time Zone, and Language” ( 27) to adjust the settings.

# Changing the Language

The current display language can be changed.

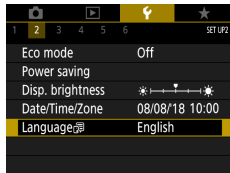

## 1 [Language

## 2 Configure the settings.

- ▲/▼/◀/▶ buttons to choose a language  
→ button

## Setting the Video System

Set the video system of any television used for display. This setting determines the image quality (frame rate) available for movies.

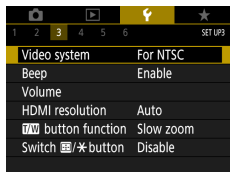

### 1 [Video system]

NTSC	For areas using the NTSC TV system, such as North America, Japan, South Korea, and Mexico.
PAL	For areas using the PAL TV system, such as Europe, Russia, China, and Australia.

## Adjusting Beeping

Specify whether the camera plays sounds when you press the shutter button halfway or use the self-timer.

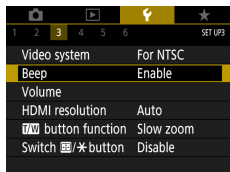

### 1 [Beep]

# Adjusting the Volume

Adjust the volume of individual camera sounds.

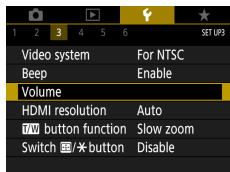

## 1 [Volume]

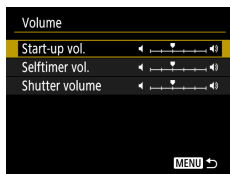

## 2 Configure the settings.

- button → buttons



## Setting the HDMI Output Resolution

Set the output resolution used for camera images when connected to a television or external recording device with an HDMI cable.

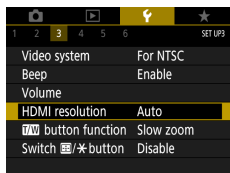

### 1 [HDMI resolution]

Auto	Images are automatically displayed at optimal resolution for connected televisions.
1080p	Output at 1080p resolution. Select if you prefer to avoid display or delay issues when switching resolution.

## Customizing Zoom Button Functions

Zoom button functions are customizable.

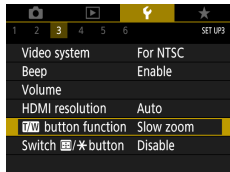

1 [T/W] button function]

Slow zoom	Zoom at low speed.
Fast zoom	Zoom at high speed.
Set MF dist	Set the focal position used in manual focusing.

## Switching AF Point Selector and AE Lock Button Functions

Functions performed by the and button can be switched.

1	2	3	4	5	6	SET UP3
		Video system				For NTSC
		Beep				Enable
		Volume				
		HDMI resolution				Auto
		button function				Slow zoom
		Switch / button				Disable

1 [Switch / button] → [Enable]

# Customizing Shooting Information Display

You can customize the details and screens of information shown on the camera or in the viewfinder when you shoot. The type of histogram and grid display are also customizable.

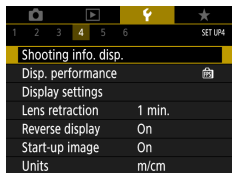

**1** [Shooting info. disp.] → [Shooting info disp settings]

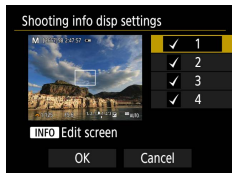

**2** Press the ▲/▼ buttons and select screens.

- For screens you prefer not to display, press the button to clear [✓].
- To edit the screen, press the **INFO** button.

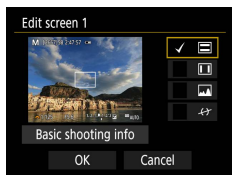

**3** Edit the screen.

- Use the ▲/▼ buttons to navigate items.
- Use the button to add a [✓] next to items to display.
- Choose [OK] to apply your settings.



## Setting a Priority for Shooting Display Performance

You can select the performance option to prioritize in shooting screen display for stills.

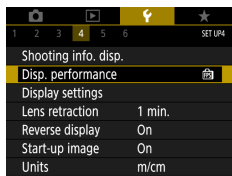

### 1 [Disp. performance]

Power saving	Screen display consumes less power.
Smooth	Even quick-moving subjects are displayed smoothly.

## Setting the Display Mode

You can select the display mode for shooting screens.

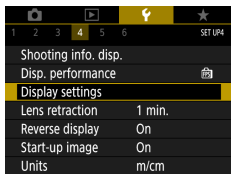

- 1 [Display settings] → [Display control]

Auto	Normally use the screen for display, but switch to the viewfinder when you look through it.
Manual	With [Manual display], you can restrict display to the screen or viewfinder.

## Lens Retraction Timing

The lens is normally retracted for safety about one minute after you press the button in shooting modes. To have the lens retracted immediately after you press the button, set the retraction timing to [0 sec.].

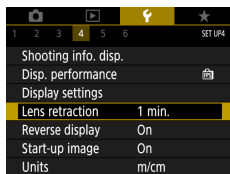

### 1 [Lens retraction]

## Setting Reverse Display

Specify whether to display a mirror image when shooting with the screen rotated around toward the front.

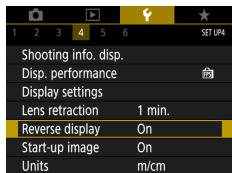

### 1 [Reverse display]



## Setting Start-up Screen Display

Specify whether to display the start-up screen when you turn the camera on.

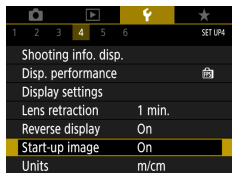

### 1 [Start-up image]

## Metric / Non-Metric Display

Change the unit of measurement shown in the zoom bar (71, 242), MF indicator (80), and elsewhere from m/cm to ft/in.

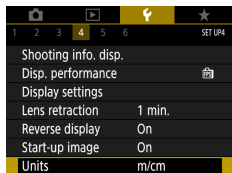

1 [Units]

# Configuring Custom Functions

Configure Custom Functions for advanced camera customization.

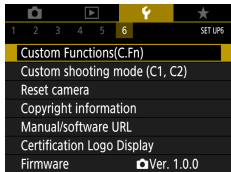

## 1 [Custom Functions (C.Fn)]

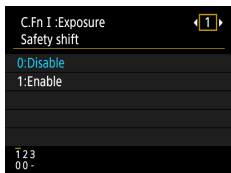

## 2 Choose an item.

- ◀▶ buttons → button

## 3 Configure the settings.

C.Fn I:Exposure Safety shift	Set to [1:Enable] for automatic adjustment of the shutter speed and aperture value to bring the exposure level closer to standard exposure if standard exposure would not be available otherwise under your specified shutter speed or aperture value in <b>Tv</b> or <b>Av</b> mode.
C.Fn II:Others Dial direction during Tv/Av	The  dial direction for adjusting the shutter speed or aperture value can be changed.
C.Fn II:Others Custom Controls	Customize functions of buttons, such as the shutter button.



## Customizing Buttons

Customize functions of buttons, such as the shutter button.

(AE lock button) and (Framing Assist – Lock button) settings apply to **P/Tv/Av/M/C1C2** modes.

(shutter button half-press) and (movie recording button) settings apply to **P/Tv/Av/M/C1C2** modes.



### 1 [C.Fn II:Others Custom Controls]



### 2 Choose a button.



### 3 Choose a function.



## Custom Shooting Modes (C1/C2)

Save commonly used shooting modes and your configured function settings for reuse. To access saved settings later, simply turn the mode dial to **C1** or **C2**. Even settings that are usually cleared when you switch shooting modes or turn the camera off (such as self-timer settings) can be retained this way.

### Settings That Can Be Saved

- Shooting modes (**P/Tv/Av/M**)
- Items set in **P/Tv/Av/M** modes
- Shooting menu settings
- Zoom positions
- Manual focus positions (📖80)

**1** Enter a shooting mode with settings you want to save, and change the settings as desired.

**2** [Custom shooting mode (C1, C2)]

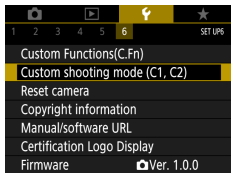

**3** [Register settings]

- Choose a custom shooting mode to save the settings to.

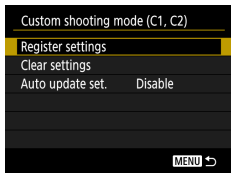



# Restoring Default Camera Settings

Restore default camera settings in **P/Tv/Av/M** modes.

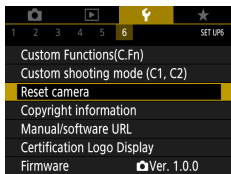

## 1 [Reset camera]

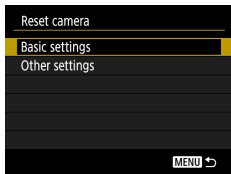

- Clear basic settings: [Basic settings] → [OK]

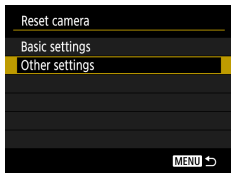

- Clear other settings: [Other settings] → choose an item → [OK]



210



## Setting Copyright Information to Record in Images

Your specified author's name and copyright details can be recorded in your shots.

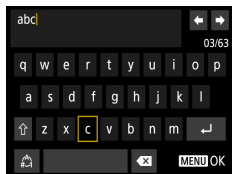
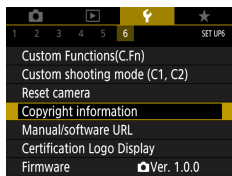

1 [Copyright information] → [Enter author's name] or [Enter copyright details]

- Enter a name → **MENU** button → [OK]



## Downloading Manuals/Software from a QR Code

A QR code can be displayed on the camera screen to access a webpage for downloading instruction manuals and software.

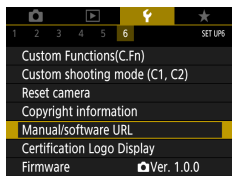

### 1 [Manual/software URL]



## Displaying Certification Logos

Some logos for certification requirements met by the camera can be viewed on the screen.

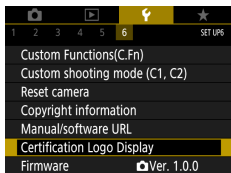

### 1 [Certification Logo Display]

## Saving Commonly Used Shooting Menu Items (My Menu)

You can save up to six commonly used shooting menu items on the ★ tab. By customizing the ★ tab, you can access these items quickly from a single screen.

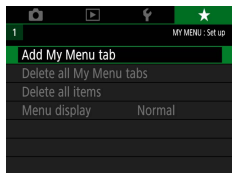

**1** ★ [Add My Menu tab] → [OK]

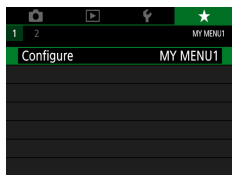

**2** [Configure]

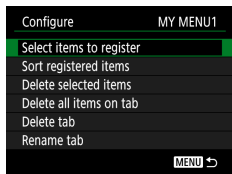

**3** [Select items to register]

- Choose an item → [OK]
- Your selected items are added to the My Menu tab.

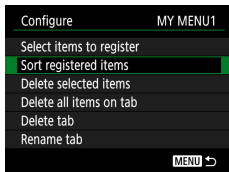

## To rearrange the items

- [Sort registered items] → choose an item to move → ▲/▼ buttons to move →  button



## Renaming My Menu Tabs

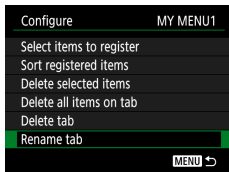

### 1 [Rename tab]

### 2 Change the tab name.

- Enter a tab name → **MENU** button → [OK]

## Deleting a My Menu Tab

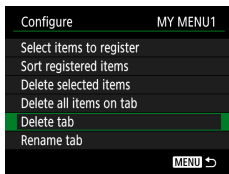

### 1 [Delete tab]

## Deleting All My Menu Tabs

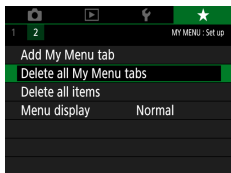

1 ★ [Delete all My Menu tabs]

## Deleting All Added Items

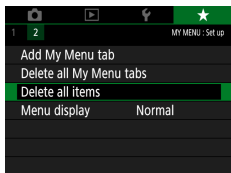

1 ★ [Delete all items]

## ● Customizing My Menu Display

Specify which screen is displayed when the **MENU** button is pressed in shooting modes.

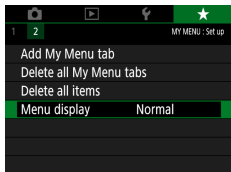

### 1 ★ [Menu display]

Normal display	Display the most recent menu, as shown for your previous operation.
Display from My Menu tab	Start display from ★ tab screens.
Display only My Menu tab	Restrict display to ★ tab screens.

# Accessories

Enjoy the camera in more ways with optional Canon accessories and other compatible accessories sold separately.

## Use of genuine Canon accessories is recommended.

This product is designed to achieve excellent performance when used with genuine Canon accessories.

Canon shall not be liable for any damage to this product and/or accidents such as fire, etc., caused by the malfunction of non-genuine Canon accessories (e.g., a leakage and/or explosion of a battery pack). Please note that any repairs your Canon product may require as a result of such malfunction are not covered under warranty and will incur a fee.

## Optional Accessories

The following camera accessories are sold separately. Note that availability varies by area, and some accessories may no longer be available.

### Power Supplies

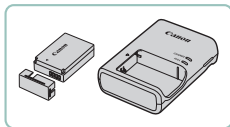

#### Battery Pack LP-E12

- Rechargeable lithium-ion battery

#### Battery Charger LC-E12 Series

- Charger for Battery Pack LP-E12



### Others

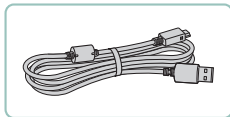

#### Interface Cable IFC-600PCU

- For connecting the camera to a computer or printer



#### Wireless Remote Control BR-E1

- Bluetooth enabled wireless remote control

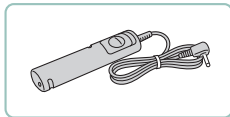

#### Remote Switch RS-60E3

- Enables remote shutter button operation (pressing the button halfway or all the way down).



### Lens Hood LH-DC90

- Prevents extraneous light outside the angle of view from entering the lens and causing flares or ghosting, which reduce image quality.



### Filter Adapter FA-DC67A

- Adapter required when mounting a 67 mm filter.

### Canon Lens Filter (67 mm dia.)

- Protects the lens and enables a variety of shooting effects.



## Printers

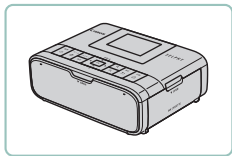

### Canon PictBridge-Compatible Printers

- Even without using a computer, you can print images by connecting the camera directly to a printer.



## Using Optional Accessories

### ● Playback on a TV

You can view your shots on a TV by connecting the camera to an HDTV with a commercially available HDMI cable (not exceeding 2.5 m / 8.2 ft., with a Type D terminal on the camera end). You can also shoot while previewing shots on the larger screen of the TV.

For details on connection or how to switch inputs, refer to the TV manual.

- 1 Make sure the camera and TV are off.**
- 2 Connect the camera to the TV.**

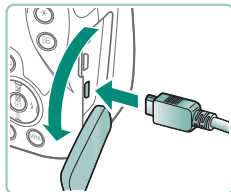
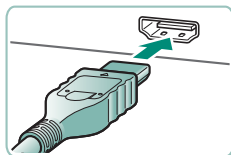

- 3 Turn the TV on and switch TV input to the connected terminal.**
- 4 Switch to playback.**

- Images from the camera are now displayed on the TV. (Nothing is displayed on the camera screen.)

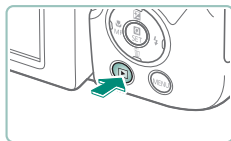

## Using a Lens Hood (Sold Separately)

For wide-angle shots of backlit subjects without using the flash, attach optional Lens Hood LH-DC90 (sold separately) to prevent light outside the angle of view from entering the lens.

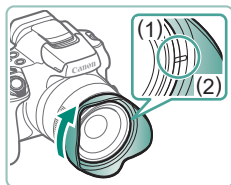

### 1 Attach the lens hood.

- Make sure the camera is off.
- Align the lens hood mark (2) with the camera mark (1), and turn the lens hood in the direction of the arrow until it locks in place.
- To remove the lens hood, turn it in the opposite direction.

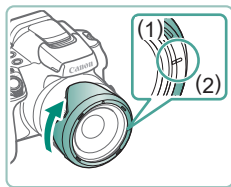
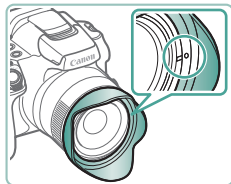

- To attach the lens hood inverted (as shown) when the hood is not used, align the lens hood mark (2) with the camera mark (1), and turn the lens hood in the direction of the arrow until it locks in place.



## Using Lens Filters (Sold Separately)

Attaching a lens filter to the camera protects the lens and allows you to shoot with various effects. To attach a lens filter, you will need Filter Adapter FA-DC67A (sold separately).

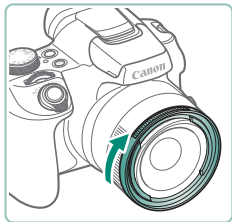

### 1 Attach the filter adapter.

- Make sure the camera is off.
- Align the notches on the camera and the filter adapter and turn the adapter in the direction of the arrow until locked.
- To remove the filter adapter, turn it in the opposite direction.

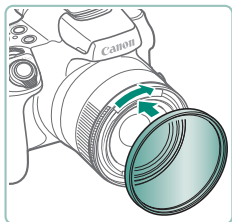

### 2 Attach a filter.

- Turn the filter in the direction of the arrow to attach it to the camera.
- Make sure not to attach the filter too tightly. Doing so could prevent removal of the filter and damage the camera.



## Shooting Remotely

Wireless Remote Control BR-E1 (sold separately) can be used to shoot. Also refer to the wireless remote control instruction manual for additional information.

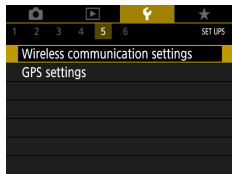

### 1 Pair the devices.

- [Wireless communication settings] → [Bluetooth function] (twice) → [Remote] → [Pairing]

### 2 Hold down both the W and T buttons on the BR-E1 for at least three seconds.

- The devices are now paired.

### 3 Set up the camera for remote shooting.

- Stills: [Stills] button → [OFF] → [Remote]
- Movies: [Movie] mode → [Remote control] → [Enable]

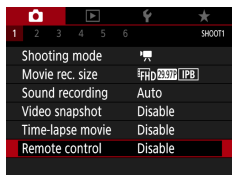

### 4 Shoot.

- For movie recording, set the remote control's release mode/movie shooting switch to [Movie] and press the release button.



## Using a Remote Switch (Sold Separately)

An optional Remote Switch RS-60E3 (sold separately) can be used to avoid camera shake that may otherwise occur when pressing the shutter button directly. This optional accessory is convenient when shooting at slow shutter speeds.

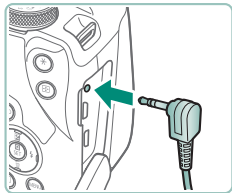

### 1 Connect the remote switch.

- Make sure the camera is off.
- Open the terminal cover and insert the remote switch plug.

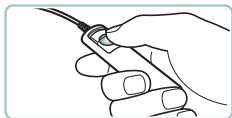

### 2 Shoot.

- To shoot, turn the camera on and press the release button on the remote switch.

## Using an External Microphone

To record with an external microphone (📖 33), connect a commercially available external microphone with a mini plug (3.5 mm diameter) to the external microphone IN terminal. Note that the built-in microphone is not used for recording when an external microphone is connected.

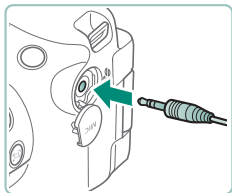

### 1 Open the cover and connect the external microphone.



## Saving Images to a Computer

Using Interface Cable IFC-600PCU or a USB cable (both sold separately; camera end: Micro-B), you can connect the camera to a computer and save images to the computer. For details on computer connections, refer to the computer user manual.

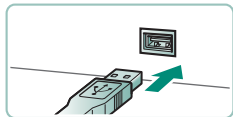
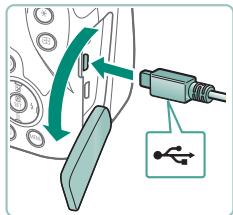

- 1 Make sure the camera is off.**
- 2 Connect the camera to the computer.**
- 3 Turn the camera on.**
- 4 Save the images to the computer.**
  - To open images, use preinstalled or commonly available software.

## Printing Images

Print your shots by connecting the camera to a PictBridge-compatible printer with a USB cable (sold separately; camera end: Micro-B). A Canon SELPHY CP series compact photo printer is used here for the sake of illustration. Screens displayed and available functions vary by printer. Also refer to the printer manual for additional information.

**1** Make sure the camera and printer are off.

**2** Connect the camera to the printer.

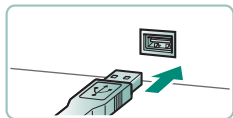
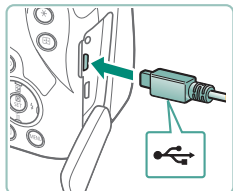

**3** Turn the printer on.

**4** Switch to playback and choose an image.

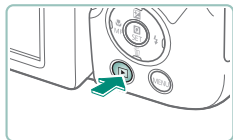



## 5 Access the printing screen.

-  button → [Print image]

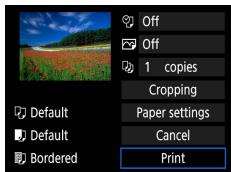

## 6 [Print]



# Tips on Using the Camera

Tips that make the camera easier to use.

# Camera Basics

Learn about setting up the camera and performing basic camera operations.

## ● Handling Precautions

- The camera is a high-precision electronic device. Avoid dropping it or subjecting it to strong impact.
- Never bring the camera near magnets, motors, or other devices that generate strong electromagnetic fields. Strong electromagnetic fields may cause malfunction or erase image data.
- If water droplets or dirt adheres to the camera or screen, wipe with a dry soft cloth, such as an eyeglass cloth. Do not rub hard or apply force.
- Never use cleaners containing organic solvents to clean the camera or screen.
- Use a blower brush to remove dust from the lens. If cleaning is difficult, contact a Customer Support Help Desk.
- Store unused battery packs in a plastic bag or other container. To maintain battery performance if you will not use the battery pack for some time, about once a year charge it and then use the camera until it runs out of power before storing the battery pack.

## ● Getting Ready

### ■ Charging the Battery Pack

- To protect the battery pack and keep it in optimal condition, do not charge it continuously for more than 24 hours.
- The charger can be used in areas with 100–240 V AC power (50/60 Hz). For power outlets in a different format, use a commercially available adapter for the plug. Never use an electrical transformer designed for traveling, which may damage the battery pack.



- Charged battery packs gradually lose their charge, even when they are not used. Charge the battery pack on (or immediately before) the day of use.

## ■ Inserting/Removing the Battery Pack and Memory Card

- If you insert the battery pack facing the wrong way, it cannot be locked into the correct position. Always confirm that the battery pack is facing the right way and locks when inserted.
- Before using a new memory card or a card formatted in another device, you should format the card with this camera.
- Recording is not possible on memory cards with a write-protect switch when the switch is in the locked position. Slide the switch to unlock it.

## ■ Setting the Date, Time, Time Zone, and Language

- Set the current date, time, and zone correctly if the [Date/Time/Zone] screen is displayed when you turn the camera on. Information you specify this way is recorded in image properties when you shoot, and it is used when you manage images by shooting date or print images showing the date.
- To set daylight saving time (1 hour ahead), set [☀️] to [☀️] on the [Date/Time/Zone] screen.
- If the date/time/zone settings have been cleared, set them again correctly.

## ● Holding the Camera

- If you have raised the flash, do not rest your fingers on it.

## Viewfinder

---

- The viewfinder display and camera screen cannot be activated at the same time.
- Some aspect ratio settings will cause black bars to be displayed on the top and bottom or left and right edges of the screen. These areas are not recorded.

## Adjusting the Screen Angle

---

- To protect the screen, always keep it closed and facing the camera body when the camera is not in use.
- Do not force the screen open any wider, which may damage the camera.

## Configuring Camera Features

---

### Quick Control Screen

---

- You can also choose options by turning the  dial.
- You can also configure Quick Control features from the Menu screen.

## Frames on the Shooting Screen

---

- Try shooting in **P** mode if no frames are displayed, if frames are not displayed around desired subjects, or if frames are displayed in the background or similar areas.

## Playback Display Options

---

- Overexposed highlights blink over the information display image when you access screens showing detailed information.
- A graph called a brightness histogram on the top of screens with detailed information shows the distribution of brightness in images. The horizontal axis represents the degree of brightness, and the vertical axis, how much of the image is at each level of brightness. Viewing this histogram enables you to check exposure.

### Switching Histograms

---

- When switched to the RGB display option, an RGB histogram showing the red, green, and blue distribution in images appears on screens with detailed information. The horizontal axis represents R, G, or B brightness, and the vertical axis, how much of the image is at that level of brightness. Viewing this histogram enables you to check image color characteristics.

# Shooting

Learn about a variety of shooting modes for stills and movies.

## ● Shooting with Camera-Determined Settings (Auto Mode/Hybrid Auto Mode)

### ■ Still Images

- A blinking [📷] icon warns that images are more likely to be blurred by camera shake. In this case, mount the camera on a tripod or take other measures to keep it still.
- If your shots are dark despite the flash firing, move closer to the subject.
- To assist in focusing, the lamp may be activated when you press the shutter button halfway in low-light conditions.
- Although you can shoot again before the shooting screen is displayed, your previous shot may determine the focus, brightness, and colors used.

### ■ Movies

- The black bars on the top and bottom of the screen are not recorded.
- When you recompose shots, the focus, brightness, and colors will be automatically adjusted.
- Recording stops automatically when the memory card becomes full or a single recording reaches approx. 29 minutes and 59 seconds.
- Although the camera may become warm when recording movies repeatedly over an extended period, this does not indicate a problem.
- Keep your fingers away from the microphone while recording movies. Blocking the microphone may prevent audio from being recorded or may cause the recording to sound muffled.
- Audio is recorded by the built-in microphone in stereo.



- Avoid touching camera controls other than the movie recording button when recording movies, because sounds made by the camera will be recorded.
- Once movie recording begins, the image display area changes and subjects are enlarged to allow for correction of significant camera shake. To record subjects at the same size shown before recording, adjust the image stabilization setting.
- During movie recording, lens operating noises from auto focusing may also be recorded. If you prefer not to record sound, choose  [Sound recording] → [Disable].
- Individual movies that exceed 4 GB may be divided into multiple files. Automatic playback of divided movie files one after another is not supported. Play each movie separately.

## Scene Icons

---

- In **AUTO**/ modes, shooting scenes determined by the camera are indicated by the icon displayed, and corresponding settings are automatically selected for optimal focusing, subject brightness, and color.
- Try shooting in **P** mode if the scene icon does not match actual shooting conditions, or if it is not possible to shoot with your expected effect, color, or brightness.

## Image Stabilization Icons

- Optimal image stabilization for the shooting conditions (Intelligent IS) is automatically applied, and the following icons are displayed.

	Image stabilization for still images (Normal)
	Image stabilization for still images when panning (Panning)*
	Image stabilization for angular camera shake and shift-shake in macro shots (Hybrid IS). For movies,  is displayed and  image stabilization is also applied.
	Image stabilization for movies, reducing strong camera shake, as when recording while walking (Dynamic)
	Image stabilization for slow camera shake, as when recording movies at telephoto (Powered)
	No image stabilization, because the camera is mounted on a tripod or held still by other means. However, during movie recording,  is displayed, and image stabilization to counteract wind or other sources of vibration is used (Tripod IS).

- \* Displayed when you pan, following moving subjects with the camera. When you follow subjects moving horizontally, image stabilization only counteracts vertical camera shake, and horizontal stabilization stops. Similarly, when you follow subjects moving vertically, image stabilization only counteracts horizontal camera shake.

## Shooting in Hybrid Auto Mode

- For more impressive digest movies, aim the camera at subjects about four seconds before shooting still images.
- Battery life is shorter in this mode than in **AUTO** mode, because digest movies are recorded for each shot.
- A digest movie may not be recorded if you shoot a still image immediately after turning the camera on, choosing mode, or operating the camera in other ways.



- Any sounds and vibrations from your camera or lens operations will be recorded in digest movies.
- Digest movie image quality is [EFFECT] 29.97P for NTSC or [EFFECT] 25.00P for PAL. This varies depending on the video system setting.
- Sounds are not played when you press the shutter button halfway or trigger the self-timer.
- Digest movies are saved as separate movie files in the following cases even if they were recorded on the same day in  mode.
  - The digest movie file size reaches approximately 4 GB, or the total recording time reaches approximately 29 minutes and 59 seconds.
  - The digest movie is protected.
  - Daylight saving time, video system, time zone, or copyright information settings are changed.
- Recorded shutter sounds cannot be modified or erased.

## ● Shooting Panoramas (Panorama Mode)

- In some scenes, expected images may not be saved, and images may not look as expected.
- Shooting may stop midway if you move the camera too slowly or quickly. However, the panorama created up to that point will still be saved.
- Images created from shots in  mode are large. Use a computer or other device to reduce panorama images if you will print them by inserting a memory card in a Canon printer. If panoramas are not compatible with certain software or Web services, try resizing them on a computer.
- The following subjects and scenes may not be stitched correctly.
  - Subjects that are moving
  - Subjects that are nearby
  - Scenes where the contrast varies greatly
  - Scenes with long stretches of the same color or pattern, such as the sea or sky

## ● Shooting Subjects in Motion (Sports Mode)

---



- Shots may look grainy because the ISO speed is increased to suit the shooting conditions.
- There may be a delay after continuous shooting before you can shoot again.
- Shooting may slow down depending on shooting conditions, camera settings, and the zoom position.
- Continuous shooting is not available in  Auto mode.

## ● Shooting Specific Scenes (Special Scene Mode)

---



### Self Portrait

---

- Areas other than people's skin may be modified, depending on the shooting conditions.
- [Smooth skin effect] settings specified in  mode are not applied in  mode.
- [Background blur] is set to [Off] and cannot be changed in  flash mode when you have raised the flash.

### Smooth Skin

---

- Areas other than people's skin may be modified, depending on the shooting conditions.
- Setting details in  mode are not applied in  mode.

### Food

---

- These color tones may not look suitable when applied to people.
- In flash photography, [Color tone] changes to the standard setting.

## Handheld Night Scene

---

- Image noise is reduced by combining consecutive shots into a single image.
- Hold the camera steady as it shoots continuously.
- There will be a delay before you can shoot again, as the camera processes and combines the images.
- Shots may look grainy because the ISO speed is increased to suit the shooting conditions.
- Excessive motion blur or certain shooting conditions may prevent you from obtaining the desired results.
- Try to keep the camera still when using the flash, because the shutter speed may be slower.









## Fireworks

---

- Mount the camera on a tripod or take other measures to keep it still and prevent camera shake. Additionally, you should set [IS mode] to [Off] when using a tripod or other means to secure the camera.
- Although no frames are displayed when you press the shutter button halfway, optimal focus is still determined.

## Recording a Variety of Movies (Movie Mode)

---

- Black bars are displayed on the top and bottom edges of the screen in  mode. The black bars indicate image areas not recorded.
- In  mode, the image display area narrows and subjects are enlarged.
- Exposure can be adjusted during recording by pressing the  button and then pressing the / buttons.
- To switch between recording with auto focus and a fixed focus, press the  button before or during recording. (Auto focus is indicated by a green  in the upper left of the  icon.)  
Note that this icon is not displayed when  [Movie Servo AF] is set to [Disable].

## ■ Recording Movies at Specific Shutter Speeds and Aperture Values (Movie Manual Exposure)

---

- Some shutter speeds may cause flickering on the screen when recording under fluorescent or LED lighting, which may be recorded.
- When the ISO speed is fixed, you can compare your specified value (where the exposure level indicator moves) to the standard exposure level by pressing the shutter button halfway. The exposure level indicator appears as [◀] or [▶] when the difference from standard exposure exceeds 3 stops.
- You can check the ISO speed in [AUTO] mode by pressing the shutter button halfway. If standard exposure cannot be obtained with your specified shutter speed and aperture value, the exposure level indicator moves, indicating the difference from standard exposure. The exposure level indicator appears as [◀] or [▶] when the difference from standard exposure exceeds 3 stops.

## ● Shooting in Program AE (P Mode)

---

- **P**: Program AE; AE: Auto Exposure
- If standard exposure cannot be obtained when you press the shutter button halfway, the shutter speed and aperture value blink in white. In this case, try adjusting the ISO speed or activating the flash (if subjects are dark), which may enable standard exposure.
- Movies can be recorded in **P** mode as well, by pressing the movie recording button. However, some items on Quick Control and Menu screens may be automatically adjusted for movie recording.
- After you press the shutter button halfway, you can adjust the combination of shutter speed and aperture value by turning the  dial (Program Shift).

## ● Shooting at Specific Shutter Speeds (Tv Mode)

---

- **Tv**: Time value
- We recommend deactivating image stabilization when shooting at slow shutter speeds on a tripod.
- With shutter speeds of 1.3 seconds or slower, ISO speed is [100] and cannot be changed.
- Blinking display of the aperture value when you press the shutter button halfway indicates that the standard exposure has not been obtained. Adjust the shutter speed until the aperture value is displayed in white.

## ● Shooting at Specific Aperture Values (Av Mode)

---

- **Av**: Aperture value (size of the opening made by the diaphragm in the lens)
- Blinking display of the shutter speed when you press the shutter button halfway indicates that the standard exposure has not been obtained. Adjust the aperture value until the shutter speed is displayed in white.

## ● Shooting at Specific Shutter Speeds and Aperture Values (M Mode)

---

- **M**: Manual
- When the ISO speed is fixed, you can compare your specified value (where the exposure level indicator moves) to the standard exposure level by pressing the shutter button halfway. The exposure level indicator appears as [◀] or [▶] when the difference from standard exposure exceeds 3 stops.
- After you set the shutter speed and aperture value, the exposure level indicator may change if you adjust the zoom or recompose the shot.
- When the ISO speed is fixed, screen brightness may change depending on your specified shutter speed and aperture value. However, screen brightness remains the same when the flash is up and the mode is set to [⚡].

- Exposure may not be as expected when the ISO speed is set to [AUTO], because the ISO speed is adjusted to ensure standard exposure relative to your specified shutter speed and aperture value.
- Image brightness may be affected by Auto Lighting Optimizer. To keep the Auto Lighting Optimizer disabled in **M** mode, add a [✓] mark to [Disable during man expo] on the Auto Lighting Optimizer setting screen.
- Calculation of standard exposure is based on the specified metering method.
- To adjust exposure when ISO speed is set to [AUTO], select a level by pressing the ▲ button on the exposure level indicator.
- With shutter speeds of 1.3 seconds or slower, ISO speed is [100] and cannot be changed.

## ● Zooming In Closer on Subjects (Digital Zoom)





- Using the zoom lever or zoom button will show the current position on the zoom bar. The zoom bar is color-coded to indicate the zoom range.
  - White range: optical zoom range where the image will not appear grainy.
  - Yellow range: digital zoom range where the image is not noticeably grainy (ZoomPlus).
  - Blue range: digital zoom range where the image will appear grainy.
- No blue range is displayed under certain pixel count settings, and you can zoom in to the maximum level in one zoom operation.
- To deactivate digital zoom, choose  [Digital zoom] → [Off].

## ● Locking Image Brightness / Exposure (AE Lock)

- AE: Auto Exposure

## ● Easily Reacquiring Subjects after Manual Zooming (Framing Assist – Seek)

---

- Some shooting information is not displayed while the camera is zoomed out.
- The white frame (which roughly shows the area displayed before you pressed the  button) is not displayed if you press the  button when recording movies. Also note that zooming and the corresponding camera operating sounds are recorded.
- To shoot at the zoom factor of the guideline screen in the white frame, press the shutter button all the way down.
- You can adjust the zoom factor that the camera reverts to when you release the  button by moving the zoom lever to resize the white frame while you hold the  button.
- The zoom factor cannot be changed with the  button after you press the shutter button all the way down in self-timer mode.

## ● Auto Zooming in Response to Subject Movement (Auto Zoom)

---









- With [ Auto: on], some shooting information is not displayed, and some shooting settings cannot be configured.
- A face may not be displayed at a constant size relative to the screen at some zoom factors, or if the person's head is tilted or facing the camera indirectly.
- Because the camera prioritizes zooming to keep subjects on the screen, it may not be possible to maintain a constant face display size, depending on subject movement and shooting conditions.
- When a detected subject moves toward the edge of the screen, the camera zooms out to keep the subject on the screen.
- When no face is detected, the camera zooms to a certain level and stops zooming until a face is detected.

- During movie recording, zooming and the corresponding camera operating sounds are recorded.
- Auto zooming to keep multiple subjects on the screen is not performed during movie recording, even if faces are detected.
- Auto zooming is not performed during continuous shooting.
- The zoom factor cannot be changed after you press the shutter button all the way down in self-timer mode.

## ■ Adjusting the Constant Face Display Size

- You can zoom in or out with the zoom lever or zoom button when [Face], [Upper body], or [Whole body] is selected, but the original zoom factor will be restored in a few seconds after you release the lever or button.
- You can clear your specified face size during movie recording by pressing the  button.



## ● Avoiding Lost Subjects after Zooming In (Framing Assist – Lock)

-  is displayed once the subject is detected after you press the  button when  is displayed in the center of the screen.
- After you recompose a shot,  may be displayed in gray if image stabilization becomes less effective and the subject cannot be centered. If so, zoom in again, press the  button, and repeat the process for choosing a subject to center.
- Image stabilization may change the composition of shots after movie recording begins.
- Some subjects and shooting conditions may prevent you from obtaining the expected results.
- No image stabilization icon is shown when you press the  button.
- To fine-tune the size of subjects gradually, move the zoom lever while  is displayed.
- The  button has no effect when  [Drive mode] is set to [High speed continuous] or [Low speed continuous], or when connected via Wi-Fi.



## ● Shooting Close-Ups (Macro)

---

- If the flash fires, vignetting may occur.
- In the yellow bar display area below the zoom bar,  will turn gray and the camera will not focus.
- To prevent camera shake, try mounting the camera on a tripod and choosing  [Drive mode] → .

## ● Shooting in Manual Focus Mode

---

- To focus more accurately, try attaching the camera to a tripod to stabilize it.
- You can also adjust the focal position with the  dial.
- You can start manual focus with magnified display (MF-point zoom).
- Press the shutter button halfway to have the camera fine-tune the focal position (Safety MF).





## ■ Easily Identifying the Focus Area (MF Peaking)

---

- Colors displayed for MF peaking are not recorded in your shots.

## ● Changing Image Quality



---

-  and  indicate different levels of image quality depending on the extent of compression. At the same size (pixel count),  offers higher image quality. Although  images have slightly lower image quality, more fit on a memory card.

## ■ Capturing in RAW Format



---

- RAW shooting is available in **P/Tv/Av/M/C1/C2** modes.
- **[RAW]** produces RAW images with maximum image quality. **[CRAW]** produces RAW images with more compact file sizes.
- RAW image data cannot be used as-is for viewing on a computer or printing. You must first use the Canon application Digital Photo Professional to convert images to ordinary JPEG or TIFF files.

- The file extension for JPEG images is .JPG, and the extension for RAW images is .CR3. File names of JPEG and RAW images captured together have the same image number.
- You can also configure this setting in  [Image quality]. To capture images in both JPEG and RAW format simultaneously, choose [RAW] or [CRAW] in [RAW].
- Only JPEG images are captured when [RAW] is set to [-] on the  [Image quality] screen, and only RAW images are captured when [JPEG] is set to [-].



## ● Changing the Flash Mode

---

- If the flash fires, vignetting may occur.
- In [] mode, mount the camera on a tripod or take other measures to keep it still and prevent camera shake. Additionally, you should set [IS mode] to [Off] when using a tripod or other means to secure the camera.
- In [] mode, even after the flash fires, ensure that the main subject does not move until the shutter sound is finished playing.

## ● Locking Brightness / Exposure in Flash Photography (FE Lock)

---

- FE: Flash Exposure
- [] blinks when standard exposure is not possible, even if you press the  button to fire the flash. Enable FE lock by pressing the  button when subjects are within flash range.

## ● Configuring Flash Settings

---

- You can also access the [Flash settings] screen by pressing the  button and immediately pressing the **MENU** button.

## ■ Changing the Flash Timing

---

- [1st curtain] is used whenever the shutter speed is 1/100 or faster, even if you select [2nd curtain].

## ■ Configuring Safety FE

---

- Shots may be captured using settings different from the values displayed when you press the shutter button halfway.

## ● Continuous Shooting

---

- During continuous shooting in **AUTO** mode, focus is locked at the position determined when you pressed the shutter button halfway.
- Shooting may stop momentarily or continuous shooting may slow down depending on shooting conditions and camera settings.
- As more shots are taken, shooting may slow down.
- There may be a delay before you can shoot again, depending on shooting conditions, the type of memory card, and how many shots you took continuously.
- Shooting may slow down if the flash fires.
- Screen display in continuous shooting differs from the images actually captured and may look out of focus.
- Fewer continuous shots may be available under some shooting conditions or camera settings.

## ● Using the Self-Timer

---

- Even when set, the self-timer has no effect if you press the movie recording button to start recording.
- More time is required between shots when the flash fires or when you have specified to take many shots. Shooting will stop automatically when the memory card becomes full.

## ● Adding a Date Stamp

---

- Shots taken without adding a date stamp can be printed with one as follows.  
However, adding a date stamp this way to images that already have one may cause it to be printed twice.
  - Print using printer functions
  - Use camera DPOF print settings to print

## ● Adjusting Image Brightness (Exposure Compensation)

---

### ■ Auto Exposure Bracketing (AEB Shooting)

---

- To clear the AEB setting, set the AEB amount to 0, following the configuration procedure.
- AEB shooting is available only in **P/Tv/Av/M/C1/C2** modes without using the flash.
- If exposure compensation is already in use, the value specified for that function is treated as the standard exposure level for AEB.

## ● Changing the ISO Speed

---

- Although choosing a lower ISO speed may reduce image graininess, there may be a greater risk of subject and camera shake in some shooting conditions.
- Choosing a higher ISO speed will increase shutter speed, which may reduce subject and camera shake and enable sufficient flash illumination for subjects farther away. However, shots may look grainy.



## ● Auto Correction of Brightness and Contrast (Auto Lighting Optimizer)

---

- This feature may increase image noise under some shooting conditions.
- When the effect of Auto Lighting Optimizer is too strong and images become too bright, set it to [Auto] or [Off].
- Images may still be bright or the effect of exposure compensation may be weak under a setting other than [Off] if you use a darker setting for exposure compensation or flash exposure compensation. For shots at your specified brightness, set this feature to [Off].
- Fewer continuous shots may be available when this setting is set to [Auto].

## ● Capturing Natural Colors (White Balance)

---

- Any correction level you set is retained even if you change the white balance option.
- On the advanced settings screen for correction, B is for blue, A for amber, M for magenta, and G for green.
- One level of blue/amber correction is equivalent to about 5 mireds on a color temperature conversion filter. (Mired: Color temperature unit representing color temperature conversion filter density)

## ■ Custom White Balance

---

- Capturing a white subject that is too bright or dark may prevent you from setting the white balance correctly.
- Choose [Cancel] to choose a different image. Choose [OK] to use that image for loading white data, but note that it may not produce a suitable white balance.
- Instead of a white object, a gray chart or 18% gray reflector (commercially available) can produce a more accurate white balance.
- The current white balance and related settings are disregarded when you capture a white subject.

## ● Shooting with Servo AF

---

- The camera may not be able to shoot while focusing, even if you press the shutter button all the way down. Keep holding down the shutter button as you follow the subject.
- Exposure is not locked in Servo AF mode when you press the shutter button halfway but is determined the moment you shoot.
- Continuous shooting with auto focus is possible by specifying Servo AF. Note that continuous shooting is slower at this time.
- Depending on the distance to the subject and the subject's speed, the camera may not be able to achieve correct focus.





## ● Choosing the AF Method

---

- Focusing may take longer or be incorrect when subjects are dark or lack contrast, or in very bright conditions.

### Tracking

---

- After you aim the camera at the subject, a white frame is displayed around the face of the main subject as determined by the camera.
- If no faces are detected when you aim the camera at people, pressing the shutter button halfway displays green frames around other areas in focus.
- With the following subjects, faces may not be detected.
  - Subjects that are distant or extremely close
  - Subjects that are dark or light
  - Faces in profile, at an angle, or partly hidden
- The camera may misinterpret non-human subjects as faces.
- Pressing the  button displays [Face select: On], and a face frame  is shown around the face detected as the main subject. Press the  button again to switch the face frame  to another detected face. Once you cycle through all detected faces, [Face select: Off] is displayed and Face Select is canceled.

## Tracking AF

---

- [AF operation] is set to [SERVO] and cannot be changed.
- Tracking may not be possible when subjects are too small or move too rapidly, or when subject color or brightness matches that of the background too closely.
-  is not available.
- To set to [MF], press the ◀ button and choose [MF].

## Moving the AF Point

---

- You can also return the AF point to the original position in the center by holding down the  button.

## Changing the IS Mode Settings

---

- The [IS mode] setting changes to [On] for movie recording, even if [Shoot only] is set.
- If image stabilization cannot prevent camera shake, mount the camera on a tripod or take other measures to hold it still. Additionally, you should set [IS mode] to [Off] when using a tripod or other means to secure the camera.

## Using Digital Tele-Converter

---

- The shutter speed at maximum telephoto (when you move the zoom lever or zoom button all the way toward **T**) may match the speed when zooming in to enlarge subjects with digital zoom.

## Storing the Zoom or MF Position



---

- By choosing  [Recall zoom/MF settings] → [MF memory] → [On] before manually focusing, you can retain the manual focus status for the next time you turn on the camera.
- In **C1/C2** mode, the camera returns to the zoom position where settings were registered.

- Restoring the zoom position is only available in **P/Tv/Av/M** modes.
- With [Auto: on], the camera does not retain the zoom position from automatic zooming when the  button is pressed.

## ● Changing Movie Recording Size

---

- [4K 29.97P] and [4K 25.00P] are only available in  mode.
- Subjects appear larger with [4K 29.97P] or [4K 25.00P] than for other movie recording sizes.
- If the camera temporarily overheats during extended 4K recording,  is displayed and recording stops. At this time, movie recording will be unavailable, even if you press the movie recording button. Following the instructions displayed, either choose a movie recording size other than [4K 29.97P] or [4K 25.00P] or turn off the camera to let it cool down before you resume recording.

## ● Configuring Sound Recording Settings

---

### ■ Adjusting the Recording Volume

---

- To restore the original recording volume, choose [Auto] on the recording screen.

## ● Configuring Movie Servo AF

---

- To keep the focus at a specific position, or if you prefer not to record mechanical sounds from the lens, you can temporarily stop Movie Servo AF by pressing the  button.





## ● Using Auto Slow Shutter

---

- Set to [Disable] when shooting moving subjects under low light, or when afterimages such as trails may occur.





## ● Miniature Model Effect in Movies (Miniature Effect Movie)

- You can also move the AF point with the  dial.
- Sound is not recorded.
- To make people and objects in the scene move quickly during playback, choose [, , or ] before recording the movie. The scene will resemble a miniature model.
- Estimated playback speed and time for a movie recorded for one minute are as follows.

Speed	Playback Time
5x	Approx. 12 sec.
10x	Approx. 6 sec.
20x	Approx. 3 sec.

## ● Recording Video Snapshots

- Video snapshots are saved to a new album when the recording time of the current album exceeds 5 min.
- The indicated playback time per video snapshot is only a guideline.
- Set the movie recording size to [] or [].
- Any video snapshots that you manually stop recording are saved as normal movies.
- No sound is recorded when you set [Playback effect] to [2x speed] or [1/2x speed].

## ● Recording Time-Lapse Movies



---

- As you configure the items, the time required [🕒] and movie playback time [▶] are displayed.
- Set [Screen auto off] to [Disable] to keep the screen on for 30 minutes after you start shooting. Set it to [Enable] to turn the screen off about 10 seconds after the first frame is captured.
- Do not disturb the camera while recording.
- To cancel recording, press the movie recording button again.
- Fast-moving subjects may look distorted in movies.
- Sound is not recorded.

# Playback

Learn about viewing your stills and movies on the camera.

## Viewing

- Pressing the  button when the camera is off starts playback, and pressing it again turns the camera off.
- The lens is retracted after about a minute during playback. You can turn the camera off when the lens is retracted by pressing the  button.
- To switch to a shooting mode during playback, press the shutter button halfway, press the movie recording button, or turn the mode dial.
- It may not be possible to play back or edit images that were renamed or already edited on a computer.
- To pause or resume movies, press the  button.
- Lines indicating the aspect ratio are displayed when you view RAW images. These lines are shown on the top and bottom of images shot at an aspect ratio of [3:2] [16:9] and on the left and right of images shot at an aspect ratio of [1:1].

## Magnifying Images







- When viewing a magnified image, you can switch to other images while maintaining magnified display by turning the  dial.













## Viewing Digest Movies

- After a moment, [SET ] will no longer be displayed when you are using the camera with information display deactivated.



## Editing Movies

### Removing the Beginning/End of Movies

- When you are specifying portions to cut, moving  to a position not identified with a  icon will cut from the beginning to the nearest  mark on the left (for ) or from the nearest  mark on the right to the end (for )
- To erase and overwrite the original movie with the edited one, choose [Overwrite] on the screen for saving edited movies.
- If the memory card lacks sufficient space, only [Overwrite] will be available.
- Movies may not be saved if the battery pack runs out while saving is in progress.
- When editing movies, you should use a fully charged battery pack.
- Image quality after compression when you choose [Save compressed version] is as follows.

Before Compression	After Compression
 ,  , 	
 ,  , 	
	
	

### Editing Digest Movies

- After [Erase this clip?] is displayed, the chapter is erased and the digest movie is overwritten when you choose [OK] and press the  button.
- Albums created when recording video snapshots can also be edited. Albums created with  [Create album] cannot be edited.

## Protecting Images

- Protected images on a memory card will be erased if you format the card.
- Protected images cannot be erased using the camera's erasure function. To erase them this way, first cancel protection.
- You can choose [All found images] or [Unprotect all found] by using [Protect images] or button → → **INFO** button when results are displayed for your specified image search conditions.
  - Choose [All found images] to protect all found images.
  - Choose [Unprotect all found] to clear protection of all found images.
- To cancel protection and remove display, press the button again when is displayed on the screen after you have chosen [Protect images] → [Select images].

## Erasing Images

- Protected images cannot be erased.
- During display of images captured in both RAW and JPEG format, pressing the button displays [Erase **RAW**], [Erase JPEG], and [Erase **RAW**+JPEG]. Choose an option to erase the image.
- You can choose [All found images] by using [Erase images] when results are displayed for your specified image search conditions.
  - Choose [All found images] to erase all found images.
- To clear selection and remove display, press the button again when is displayed on the screen after you have chosen [Erase images] → [Select images].

## Erasing Multiple Images at Once

- Choosing an image captured in both RAW and JPEG format will erase both versions.

## ■ Adding Images to Print Orders (DPOF)

---

- RAW images and movies cannot be selected.
- Not all of your DPOF settings may be applied in printing by the printer or photo development service, in some cases.
- Setting [Date] to [On] may cause some printers to print the date twice.

## ■ Adding Images to a Photobook

---

- RAW images and movies cannot be selected.



## ■ Correcting Red-Eye

---

- Once red-eye is corrected, frames are displayed around corrected image areas.
- Some images may not be corrected accurately.

## ■ Cropping

---



- RAW images cannot be edited.
- Cropped images cannot be cropped again.
- Cropped images cannot be resized.
- Cropped images will have a lower pixel count than uncropped images.
- While previewing the cropped image, you can adjust the cropping frame size, position, and aspect ratio.
- You can also specify the cropping frame size, position, orientation, and aspect ratio by choosing  [Cropping], choosing an image, and pressing the  button.

## ■ Resizing Images





---

- RAW images cannot be edited.

## Rating Images

- By viewing only images with a specified rating, you can restrict the following operations to all images with that rating.
  - Viewing, protecting, erasing, or adding images to a print list or photobook, viewing slideshows
- To remove ratings, press the  button, choose [OFF] in the [★] setting item, and then press the  button.
- When rating images using  [Rating], you can apply a rating to all images in a folder.

## Viewing Slideshows

- After you start playback and [Loading image] is displayed, the slideshow starts in a few seconds.
- Press the **MENU** button to stop the slideshow.
- The camera's power-saving functions are deactivated during slideshows.
- To pause or resume slideshows, press the  button.
- You can switch to other images during playback by pressing the   buttons. For fast-forward or fast-rewind, hold the   buttons down.
- On the slideshow start screen, you can choose [Set up] to configure slideshow repetition, display time per image, and the transition between images.

## Finding Images Matching Specified Conditions

- You can apply protection or ratings exclusively to the found images in yellow frames by pressing the  button.
- If you edit images and save them as new images, a message is displayed, and the images that were found are no longer shown.





## Combining Video Snapshots

- Albums created with  [Create album] cannot be edited.

## Wireless Features

Learn about wireless camera features.

### ● Saving Camera Images to a Smartphone

- Any active Bluetooth connections will be lost if you remove the camera battery pack. The connection will be reestablished when you insert the battery pack and turn on the camera.
- Battery life may be shorter when you use the camera after pairing with a smartphone, because power is consumed even when the camera is off.
- Before bringing the camera to places where the use of electronic devices is restricted, disable active Bluetooth communication (which is used even when the camera is off) by choosing  [Wireless communication settings] → [Bluetooth function] (twice) → [Disable].
- To turn off Wi-Fi signal transmission, choose  [Wireless communication settings] → [Wi-Fi settings] → [Wi-Fi] → [Disable].
- You can change the camera nickname in  [Wireless communication settings] → [Nickname].
- You can send images to a smartphone connected via Wi-Fi or paired via Bluetooth (Android devices only) by choosing the images from the camera's playback screen. Press the  button and choose .

### ■ Restricting Image Viewing

- Remote live view shooting in Camera Connect is not possible unless [Viewable imgs] is set to [All images].





## ● Features Used with Smartphones

### ■ Shooting Remotely as You View a Live Image on the Smartphone

- If the camera temporarily overheats during extended 4K recording or full HD recording at a high frame rate, [🔥] is displayed and recording stops. At this time, movie recording will be unavailable, even if you press the movie recording button. Following the instructions displayed, either choose a movie recording size other than [4K 29.97P], [4K 25.00P], [FHD 59.94P], or [FHD 50.00P] or turn off the camera to let it cool down before you resume recording.

### ■ Geotagging Images as You Shoot

- The location information added to movies is acquired initially, when you start recording.
- Shots may not be geotagged immediately after the camera is turned on.
- Others may be able to locate or identify you by using location data in your geotagged still images or movies. Be careful when sharing these images with others, as when posting images online where many others can view them.
- By accessing playback screens with detailed information, you can check location information added to your shots. Latitude, longitude, elevation, and UTC (shooting date and time) are listed from top to bottom.
- UTC: Coordinated Universal Time, essentially the same as Greenwich Mean Time
- [---] is shown instead of numerical values for items not available on your smartphone or items not recorded correctly.

## ● Connecting to Printers via Wi-Fi

---

### ■ Establishing a Connection via an Access Point

---

- The PIN code displayed when you choose [WPS (PIN mode)] in [Connect with WPS] is entered on the access point. Choose a device on the [Select a device for connection] screen. For further details, refer to the user manual included with your access point.

## ● Sending Images to a Computer Automatically

---

### Sending Images Automatically

---

- When using auto image transfer, ensure that the battery pack has sufficient charge. Power saving on the camera is deactivated.
- Any images captured after auto image transfer are not sent to the computer then. They are sent automatically when the camera is restarted.
- If auto image transfer to a computer does not begin automatically, try restarting the camera.
- To stop sending images automatically, choose [Auto send images to computer] → [Auto send] → [Disable].

## ● Uploading Images to Web Services

---

### Registering CANON iIMAGE GATEWAY

---

- Make sure initially that your computer or smartphone mail application is not configured to block email from relevant domains, which may prevent you from receiving the notification message.

### Registering Other Web Services

---

- If any configured settings change, update camera settings by registering affected Web services on the camera.

## ■ Uploading Images to Web Services

---

- To view images uploaded to CANON iMAGE GATEWAY on a smartphone, try the dedicated Canon Online Photo Album app. Download and install the Canon Online Photo Album app for iPhones or iPads from the App Store or for Android devices from Google Play.

# Function Settings

Learn about setting up basic camera functions.

## Selecting and Creating Folders

- Folders are named as in 100CANON, with a three-digit folder number followed by five letters or numbers.
- Folders with numbers in the range 100–999 can be created.

## Changing File Numbering

- Regardless of the option selected in this setting, shots may be numbered consecutively after the last number of existing images on newly inserted memory cards. To start saving shots from 0001, use an empty (or formatted) memory card.

## Formatting Memory Cards

- Formatting or erasing data on a memory card only changes file management information on the card and does not erase the data completely. When disposing of or transferring ownership of memory cards, take steps to protect personal information if necessary, as by physically destroying cards.
- The total card capacity indicated on the formatting screen may be less than the advertised capacity.
- Low-level formatting takes longer than initial formatting, because data is erased from all storage regions of the memory card.
- You can cancel low-level formatting in progress by choosing [Cancel]. In this case, all data will be erased, but the memory card can be used normally.



## ● Adjusting Power-Saving Features

---

- To conserve battery power, you should normally choose  [Power saving] → [Display off] and [Auto power off] → [1 min.] or less.
- The [Display off] setting is applied even if you set [Auto power off] to [Disable].
- [Display off] and [Auto power off] are not available when Eco mode is set to [On].







## ● Adjusting Screen Brightness

---

- For maximum brightness (regardless of the  [Disp. Brightness] setting), press and hold the **INFO** button for at least one second from the shooting screen or during single-image display. To restore the original brightness, press and hold the **INFO** button again for at least one second or restart the camera.



## ● Customizing Shooting Information Display

---

- To make the grid pattern smaller, choose  [Shooting info. disp.] → [Grid display].
- To switch from a brightness histogram to an RGB histogram or adjust the display size, choose  [Shooting info. disp.] → [Histogram disp].
- The electronic level is not displayed when  [AF method] is set to [AF   ].

## ● Configuring Custom Functions

---

- To restore  [Custom Functions (C.Fn)] defaults (except [Custom Controls] settings), choose  [Reset camera] → [Other settings] → [Custom function (C.Fn)] → [OK].



## ■ Customizing Buttons

---

- To restore [Custom Controls] defaults, choose  [Reset camera] → [Other settings] → [Custom Controls] → [OK].

## ● Custom Shooting Modes (C1/C2)

---

- To edit saved settings (other than shooting mode), choose **C1** or **C2**, change the settings, and then choose  [Custom shooting mode (C1, C2)] → [Register settings] again. These setting details are not applied in other shooting modes.
- To reset saved settings to their defaults, choose  [Custom shooting mode (C1, C2)] → [Clear settings], and then choose the custom shooting mode.
- To automatically update your saved settings with any changes to settings that you make while shooting in **C1/C2** mode, set  [Custom shooting mode (C1, C2)] → [Auto update set.] → [Enable].



## ● Restoring Default Camera Settings

---

- Basic settings such as [Language ] and [Date/Time/Zone] are not restored to defaults.

## ● Setting Copyright Information to Record in Images

---

- To check the information entered, choose  [Copyright information] → [Display copyright info].
- You can delete both the registered author's name and copyright details at the same time by choosing  [Copyright information] → [Delete copyright information], but copyright information already recorded in images is not deleted.

## ● Saving Commonly Used Shooting Menu Items (My Menu)

---

- You can add up to [★5] My Menu tabs.
- Grayed-out items can also be specified for your added My Menu tabs, but they may not be available in some shooting modes.
- Choosing [Configure] → [Delete all items on tab] → [OK] on your added My Menu tab will delete all items added to the tab.

# Accessories

Learn about accessories.

## Optional Accessories

### Power Supplies

- The battery charger can be used in areas with 100 – 240 V AC power (50/60 Hz).
- For power outlets in a different format, use a commercially available adapter for the plug. Never use an electrical transformer designed for traveling, which may damage the battery pack.

### Others

- A lens filter and lens cap cannot be attached to the camera at the same time.

## Using Optional Accessories

### Playback on a TV

- Some information may not be displayed when viewing images on a TV.
- During HDMI output, display of the next image may take some time if you switch between 4K and HD movies, or movies of different frame rates.

### Using a Lens Hood (Sold Separately)

- Vignetting may occur if you use the flash when the lens hood is attached.
- A lens hood and filter adapter cannot be attached to the camera at the same time.





## ■ Using Lens Filters (Sold Separately)

- We recommend the use of genuine Canon filters (67 mm dia.).
- When not using auto focus to shoot, set the manual focus option [Safety MF] to [On].
- If you use the flash with the filter adapter attached, portions of the image may appear darker.
- When using the filter adapter, be sure to use only one filter at a time. Attaching multiple filters may cause them to fall off, and it may damage the camera or filter adapter.
- Do not grip the filter adapter tightly.
- Remove the filter adapter when not using a filter.
- A lens hood and filter adapter cannot be attached to the camera at the same time.

## ■ Shooting Remotely

- Auto power off is triggered in about two minutes, even if you have set it for one minute.
- To clear pairing information, choose  [Wireless communication settings] → [Bluetooth function] → [Check/clear connection info] and then press the **INFO** button.

## ■ Using an External Microphone

- Any attenuator settings you have configured are also applied to recording with the external microphone.
- Connecting an external microphone will deactivate [Wind filter].

# Troubleshooting

If you think there is a problem with the camera, first check the following. If the issue persists, contact a Customer Support Help Desk.

## ■ Power

---

Nothing happens when the power button is pressed.

- Dirty battery terminals reduce battery performance. Try cleaning the terminals with a cotton swab and reinserting the battery pack a few times.

The battery pack runs out of power quickly.

- Battery performance decreases at low temperatures. Try warming the battery pack a little by putting it in your pocket, for example, ensuring that the terminals do not touch any metal objects.
- Dirty battery terminals reduce battery performance. Try cleaning the terminals with a cotton swab and reinserting the battery pack a few times.
- If these measures do not help and the battery pack still runs out of power soon after charging, it has reached the end of its useful life. Purchase a new battery pack.

The battery pack is swollen.

- Battery swelling is normal and does not pose any safety concerns. However, if battery swelling prevents the battery pack from fitting in the camera, contact a Customer Support Help Desk.

## ■ Shooting

---

Cannot shoot.

- During playback, press the shutter button halfway.

Strange display on the screen when shooting.

- Note that the following display problems are not recorded in still images but are recorded in movies.
  - The screen may flicker and horizontal banding may appear under fluorescent or LED lighting.

Movie recording or playback suddenly stops.

- For [4K 29.97P] or [4K 25.00P], use a UHS-I memory card with a UHS speed class of 3.

[🔋] is displayed and the camera turns off automatically.

- After extended shooting, or shooting in hot weather, [🔋] is displayed to indicate that the camera will soon turn off automatically. In this case, turn off the camera and allow it to cool down.

Continuous shooting is much slower.

- Under high temperatures, continuous shooting may be much slower. In this case, turn off the camera and allow it to cool down.

Shots are out of focus.

- Confirm that unneeded functions such as macro are deactivated.
- Try shooting with AF lock.

No AF points are displayed and the camera does not focus when the shutter button is pressed halfway.

- To have AF points displayed and the camera focus correctly, try composing the shot with higher-contrast subject areas centered before pressing the shutter button halfway (or pressing it halfway repeatedly).

Subjects in shots look too dark.

- Adjust brightness by using exposure compensation.
- Use AE lock or spot metering.

Subjects look too bright, highlights are washed-out.

- Adjust brightness by using exposure compensation.
- Use AE lock or spot metering.
- Reduce the lighting on subjects.

Shots look too dark despite the flash firing.

- Adjust brightness by using flash exposure compensation or changing the flash output level.
- Increase the ISO speed.

Subjects in flash shots look too bright, highlights are washed-out.

- Adjust brightness by using flash exposure compensation or changing the flash output level.

## Recording Movies

---

Subjects look distorted.

- Subjects that pass in front of the camera quickly may look distorted.

## Wi-Fi

---

Cannot access the Wi-Fi menu by pressing the (i) button.

- The Wi-Fi menu cannot be accessed while the camera is connected to a printer or computer via a cable. Disconnect the cable.

Cannot connect to the access point.

- Confirm that the access point channel is set to a channel supported by the camera. Note that instead of auto channel assignment, it is advisable to specify a supported channel manually. For details on supported channels, check the Canon website.

Images take a long time to send. / The wireless connection is disrupted.

- Do not use the camera near sources of Wi-Fi signal interference such as microwave ovens or other equipment operating on the 2.4 GHz band.
- Bring the camera closer to the other device you are trying to connect to (such as the access point), and make sure there are no objects between the devices.

Cannot pair with a smartphone via Bluetooth.

- Pairing with a smartphone via Bluetooth is not possible if you are using Wireless Remote Control BR-E1 after choosing [Bluetooth function] → [Bluetooth function] → [Remote].

## Error Codes

---

Error codes (Errxx) and recommended responses are displayed.



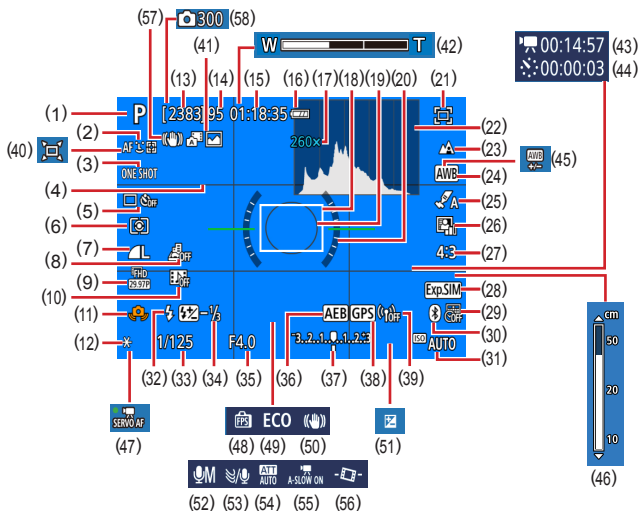

- Error codes are displayed if camera problems occur. If the problem persists, write down the error code (Errxx) and contact a Customer Support Help Desk.
- Error numbers for wireless communication errors (Errxx) are displayed in the upper right of the screen accessed by choosing  [Wireless communication settings] → [Wi-Fi function]. Press the **INFO** button to view error details on information display screens.

# On-Screen Information

## When Shooting





- |                               |                                     |
|-------------------------------|-------------------------------------|
| (1) Shooting mode, Scene icon | (9) Movie recording size            |
| (2) AF method                 | (10) Video snapshot                 |
| (3) AF operation              | (11) Camera shake warning           |
| (4) Grid lines                | (12) AE lock                        |
| (5) Drive mode/Self-timer     | (13) Recordable shots               |
| (6) Metering mode             | (14) Maximum continuous shots       |
| (7) Image quality             | (15) Movie recording time available |
| (8) Miniature effect movie    | (16) Battery level                  |

- (17) Zoom magnification, Digital tele-converter
- (18) AF point
- (19) Spot AE point frame
- (20) Electronic level
- (21) Framing Assist – Lock
- (22) Histogram
- (23) Focus range
- (24) White balance
- (25) Style settings
- (26) Auto Lighting Optimizer
- (27) Still image aspect ratio
- (28) Exposure simulation
- (29) Date stamp
- (30) Bluetooth connection status
- (31) ISO speed
- (32) Flash mode
- (33) Shutter speed
- (34) Flash exposure compensation / Flash output level
- (35) Aperture value
- (36) AEB
- (37) Exposure level indicator
- (38) Bluetooth smartphone connection, GPS acquisition status
- (39) Wi-Fi signal strength
- (40)  Auto
- (41) Hybrid Auto mode / Digest type
- (42) Zoom bar
- (43)  Time required
- (44)  Interval
- (45) White balance correction
- (46) MF indicator
- (47) Movie Servo AF
- (48) Display performance
- (49) Eco mode
- (50) Image stabilization
- (51) Exposure compensation
- (52) Audio recording mode
- (53) Wind filter
- (54) Attenuator
- (55)  Auto slow shutter
- (56) Auto level
- (57) Intelligent IS
- (58)  Number of shots

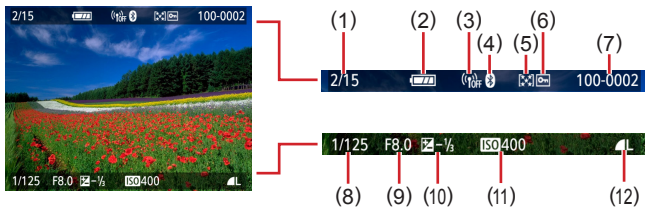
## During Playback





- |                                  |                                  |
|----------------------------------|----------------------------------|
| (1) Current image / Total images | (7) Folder number - File number  |
| (2) Battery level                | (8) Shutter speed                |
| (3) Wi-Fi signal strength        | (9) Aperture value               |
| (4) Bluetooth connection status  | (10) Exposure compensation level |
| (5) Rating                       | (11) ISO speed                   |
| (6) Protection                   | (12) Image quality*              |

\* Images captured with resizing, cropping, or red-eye correction applied are labeled with . Cropped images are labeled with .

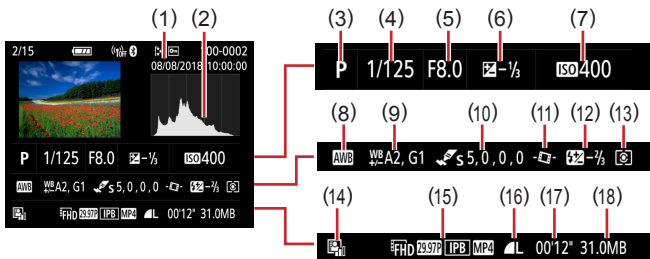



- |                                 |                                  |
|---------------------------------|----------------------------------|
| (1) Shooting date/time          | (10) Style setting details       |
| (2) Histogram                   | (11) Auto level                  |
| (3) Shooting mode               | (12) Flash exposure compensation |
| (4) Shutter speed               | (13) Metering mode               |
| (5) Aperture value              | (14) Auto Lighting Optimizer     |
| (6) Exposure compensation level | (15) Movie recording size        |
| (7) ISO speed                   | (16) Image quality*              |
| (8) White balance               | (17) Movie recording time        |
| (9) White balance correction    | (18) File size                   |

\* Images captured with resizing, cropping, or red-eye correction applied are labeled with . Cropped images are labeled with .

## Precautions for Wireless Features

- Before goods or technologies in the camera regulated by the Foreign Exchange and Foreign Trade Act are exported (which includes bringing them outside Japan or showing them to non-residents in Japan), export or service transaction permission may be required from the Japanese government.
- Because this product includes American encryption items, it falls under U.S. Export Administration Regulations, and cannot be exported to or brought into a country under U.S. trade embargo.
- Be sure to make notes of the Wi-Fi settings you use. The wireless settings saved to this product may change or be erased due to incorrect operation of the product, the effects of radio waves or static electricity, or accident or malfunction. Please note that Canon accepts no responsibility for direct or indirect damages or loss of earnings resulting from a degradation or disappearance of content.
- When transferring ownership, disposing of the product, or sending it for repair, restore the default wireless settings by erasing any settings you have entered.
- Canon will not make compensation for damages resulting from loss or theft of the product.  
Canon accepts no responsibility for damages or loss resulting from unauthorized access or use of target devices registered on this product due to loss or theft of the product.
- Be sure to use the product as directed in this guide.  
Be sure to use the wireless function of this product within the guidelines noted in this guide. Canon accepts no responsibility for damages or loss if the function and product are used in ways other than as described in this guide.

## Security Precautions

Because Wi-Fi uses radio waves to transmit signals, security precautions more stringent than when using a LAN cable are required.

Keep the following points in mind when using Wi-Fi.

- Only use networks you are authorized to use.  
This product searches for Wi-Fi networks in the vicinity and displays the results on the screen. Networks you are not authorized to use (unknown networks) may also be displayed. However, attempting to connect to or using such networks could be regarded as unauthorized access. Be sure to use only networks you are authorized to use, and do not attempt to connect to other unknown networks.

If security settings have not been properly set, the following problems may occur.

- Transmission monitoring  
Third parties with malicious intent may monitor Wi-Fi transmissions and attempt to acquire the data you are sending.
- Unauthorized network access  
Third parties with malicious intent may gain unauthorized access to the network you are using to steal, modify, or destroy information. Additionally, you could fall victim to other types of unauthorized access such as impersonation (where someone assumes an identity to gain access to unauthorized information) or springboard attacks (where someone gains unauthorized access to your network as a springboard to cover their tracks when infiltrating other systems).

To prevent these types of problems from occurring, be sure to thoroughly secure your Wi-Fi network.

Only use this camera's Wi-Fi function with a proper understanding of Wi-Fi security, and balance risk and convenience when adjusting security settings.

## Third-Party Software

- AES-128 Library

Copyright (c) 1998-2008, Brian Gladman, Worcester, UK. All rights reserved.

### LICENSE TERMS

The redistribution and use of this software (with or without changes) is allowed without the payment of fees or royalties provided that:

1. source code distributions include the above copyright notice, this list of conditions and the following disclaimer;
2. binary distributions include the above copyright notice, this list of conditions and the following disclaimer in their documentation;
3. the name of the copyright holder is not used to endorse products built using this software without specific written permission.

### DISCLAIMER

This software is provided 'as is' with no explicit or implied warranties in respect of its properties, including, but not limited to, correctness and/or fitness for purpose.

- CMSIS Core header files  
Copyright (C) 2009-2015 ARM Limited.  
All rights reserved.

Redistribution and use in source and binary forms, with or without modification, are permitted provided that the following conditions are met:

- Redistributions of source code must retain the above copyright notice, this list of conditions and the following disclaimer.
- Redistributions in binary form must reproduce the above copyright notice, this list of conditions and the following disclaimer in the documentation and/or other materials provided with the distribution.
- Neither the name of ARM nor the names of its contributors may be used to endorse or promote products derived from this software without specific prior written permission.

THIS SOFTWARE IS PROVIDED BY THE COPYRIGHT HOLDERS AND CONTRIBUTORS "AS IS" AND ANY EXPRESS OR IMPLIED WARRANTIES, INCLUDING, BUT NOT LIMITED TO, THE IMPLIED WARRANTIES OF MERCHANTABILITY AND FITNESS FOR A PARTICULAR PURPOSE ARE DISCLAIMED. IN NO EVENT SHALL COPYRIGHT HOLDERS AND CONTRIBUTORS BE LIABLE FOR ANY DIRECT, INDIRECT, INCIDENTAL, SPECIAL, EXEMPLARY, OR CONSEQUENTIAL DAMAGES (INCLUDING, BUT NOT LIMITED TO, PROCUREMENT OF SUBSTITUTE GOODS OR SERVICES; LOSS OF USE, DATA, OR PROFITS; OR BUSINESS INTERRUPTION) HOWEVER CAUSED AND ON ANY THEORY OF LIABILITY, WHETHER IN CONTRACT, STRICT LIABILITY, OR TORT (INCLUDING NEGLIGENCE OR OTHERWISE) ARISING IN ANY WAY OUT OF THE USE OF THIS SOFTWARE, EVEN IF ADVISED OF THE POSSIBILITY OF SUCH DAMAGE.

- KSDK Peripheral Drivers, Flash / NVM, KSDK H/W Abstraction Layer (HAL)  
(c) Copyright 2010-2015 Freescale Semiconductor, Inc.  
ALL RIGHTS RESERVED.

Redistribution and use in source and binary forms, with or without modification, are permitted provided that the following conditions are met:

- \* Redistributions of source code must retain the above copyright notice, this list of conditions and the following disclaimer.
- \* Redistributions in binary form must reproduce the above copyright notice, this list of conditions and the following disclaimer in the documentation and/or other materials provided with the distribution.
- \* Neither the name of the <organization> nor the names of its contributors may be used to endorse or promote products derived from this software without specific prior written permission.

THIS SOFTWARE IS PROVIDED BY THE COPYRIGHT HOLDERS AND CONTRIBUTORS "AS IS" AND ANY EXPRESS OR IMPLIED WARRANTIES, INCLUDING, BUT NOT LIMITED TO, THE IMPLIED WARRANTIES OF MERCHANTABILITY AND FITNESS FOR A PARTICULAR PURPOSE ARE DISCLAIMED. IN NO EVENT SHALL <COPYRIGHT HOLDER> BE LIABLE FOR ANY DIRECT, INDIRECT, INCIDENTAL, SPECIAL, EXEMPLARY, OR CONSEQUENTIAL DAMAGES (INCLUDING, BUT NOT LIMITED TO, PROCUREMENT OF SUBSTITUTE GOODS OR SERVICES; LOSS OF USE, DATA, OR PROFITS; OR BUSINESS INTERRUPTION) HOWEVER CAUSED AND ON ANY THEORY OF LIABILITY, WHETHER IN CONTRACT, STRICT LIABILITY, OR TORT (INCLUDING NEGLIGENCE OR OTHERWISE) ARISING IN ANY WAY OUT OF THE USE OF THIS SOFTWARE, EVEN IF ADVISED OF THE POSSIBILITY OF SUCH DAMAGE.

## Personal Information and Security Precautions

If personal information and/or Wi-Fi security settings, such as passwords, etc., are saved on the camera, please be aware that such information and settings may still remain in the camera.

When transferring the camera to another person, disposing of it, or sending it for repair, be sure to take the following measures to prevent the leakage of such information and settings.

- Erase registered Wi-Fi security information by choosing [Clear settings] in the Wi-Fi settings.

## Trademarks and Licensing

- Microsoft and Windows are trademarks or registered trademarks of Microsoft Corporation in the United States and/or other countries.
- Macintosh and Mac OS are trademarks of Apple Inc., registered in the U.S. and other countries.
- App Store, iPhone, and iPad are trademarks of Apple Inc.
- The SDXC logo is a trademark of SD-3C, LLC.
- HDMI, the HDMI logo and High-Definition Multimedia Interface are trademarks or registered trademarks of HDMI Licensing LLC.
- Wi-Fi®, Wi-Fi Alliance®, WPA™, WPA2™ and Wi-Fi Protected Setup™ are trademarks or registered trademarks of the Wi-Fi Alliance.
- The Bluetooth® word mark and logos are registered trademarks owned by Bluetooth SIG, Inc. and any use of such marks by Canon Inc. is under license. Other trademarks and trade names are those of their respective owners.
- All other trademarks are the property of their respective owners.
- This device incorporates exFAT technology licensed from Microsoft.
- This product is licensed under AT&T patents for the MPEG-4 standard and may be used for encoding MPEG-4 compliant video and/or decoding MPEG-4 compliant video that was encoded only (1) for a personal and non-commercial purpose or (2) by a video provider licensed under the AT&T patents to provide MPEG-4 compliant video. No license is granted or implied for any other use for MPEG-4 standard.



## Disclaimer

- Unauthorized reproduction of this guide is prohibited.
- All measurements based on Canon testing standards.
- Information subject to change without notice, as are product specifications and appearance.
- Illustrations and screenshots in this guide may differ slightly from the actual equipment.
- The above items notwithstanding, Canon cannot be held liable for any loss arising from the use of this product.



# Index

## Numbers

1-point AF 107

## Roman

## A

Accessories 219, 268  
AEB shooting 96, 248  
AE lock 72, 242  
AF-assist beam 111  
AF lock 82  
AF method 107, 250  
AF points 107, 250  
AF-point zoom 80, 245  
Art bold effect (shooting mode) 62  
Aspect ratio 84  
Attenuator 118  
Auto level 113  
Auto Lighting Optimizer 99, 249  
Auto mode (shooting mode) 52, 234  
Av (shooting mode) 69, 241

## B

Battery charger 219, 268  
Battery pack  
    Charging 23, 230  
    Eco mode 189  
    Power saving 190, 265  
Beep 195  
Bluetooth 156, 181, 260

## C

C1/C2 (shooting mode) 209, 266  
Camera  
    Resetting 210, 266

Camera Connect 156, 260  
CANON iIMAGE GATEWAY 174, 262  
Changing or deleting connection  
    information 182  
Charging 23, 230  
Color temperature 249  
Color (white balance) 103, 249  
Compression 83, 245  
Continuous shooting 92, 247  
Creative filters (shooting mode) 61  
Cropping 145, 258  
Custom Functions 207, 265  
Custom white balance 104, 249

## D

Date/time/zone  
    Changing 192  
    Settings 27, 231  
Digital tele-converter 114, 251  
Digital zoom 71, 242  
Display language  
    Changing 193  
    Settings 27, 231  
DPOF 141, 258

## E

Eco mode 189  
Editing  
    Cropping 145, 258  
    Red-eye correction 144, 258  
    Resizing images 147, 258  
Erasing 139, 257  
Error messages 270  
Exposure  
    AE lock 72, 242

- Compensation 95, 248
- FE lock 87, 246
- External microphone 225, 269
- F**
- Face+Tracking 107, 250
- FE lock 87, 246
- File numbering 185, 264
- Fireworks (shooting mode) 59, 239
- Fish-eye effect (shooting mode) 62
- Flash
  - Flash exposure compensation 88
  - Flash off 86
  - Flash timing 90, 247
  - Mode 86, 246
  - Slow synchro 86
- Flash exposure compensation 88
- Flash off 86
- Focusing
  - AF lock 82
  - AF points 107, 250
  - MF peaking 81, 245
  - Servo AF 106, 250
- Focus range
  - Macro 79, 245
  - Manual focus 80, 245
- Food (shooting mode) 58, 238
- Framing assist
  - Lock 77, 244
  - Seek 73, 243

- G**
- Geotagging images 166, 261
- Grainy B/W (shooting mode) 62
- Grid lines 200, 265

- H**
- Handheld night scene (shooting mode) 59, 239
- HDMI cable 221, 268
- Hybrid Auto (shooting mode) 54, 236

- I**
- Icons 274, 276
- Image quality 83, 245
- Images
  - Display period 85
  - Erasing 139, 257
  - Protecting 136, 257
- Image stabilization 112, 251
- Index display 131
- Indicator 37
- ISO speed 98, 248

- J**
- Jump display 151

- L**
- Lamp 111

- M**
- Macro (focus range) 79, 245
- Magnified display 129, 255
- Manual focus (focus range) 80, 245
- Memory cards 24, 231
- Menu
  - Basic operations 40
  - Table 43
- Metering method 100
- MF (Manual focusing) 80, 245
- MF peaking 81, 245
- Miniature effect movie 121, 253
- Miniature effect (shooting mode) 63, 64

Movie manual exposure (shooting mode) 65, 240

## Movies

Create album 152, 259

Editing 132, 256

Recording size 116, 252

Movie Servo AF 119, 252

M (shooting mode) 70, 241

My Menu 214, 267

## P

Panoramas (shooting mode) 55, 237

Photobook set-up 143, 258

PictBridge 167, 220, 227

Pixel count (image size) 83, 245

Portrait (shooting mode) 58

Power 219, 268

Power saving 190, 265

Printing 141, 167, 227, 258, 262

Program AE 67, 240

Protect images 136, 257

Protecting 136, 257

P (shooting mode) 67, 240

## Q

Quick Control screen 42

Basic operations 39, 232

## R

Rating 148, 259

RAW 83, 245

Red-eye correction 144, 258

Resetting 210, 266

Resizing images 147, 258

Rotating 138

## S

Saving images to a computer 226

## Screen

Display language 27, 193, 231

Icons 274, 276

Searching 150, 259

Self portrait (shooting mode) 58, 60, 238

Self-timer 93, 247

Sending images 174, 262

Sending images to a smartphone 158, 165, 260, 261

Sending images to Web services 174, 262

Servo AF 106, 250

## Shooting

Shooting information 274

Slideshow 149, 259

Smooth skin (shooting mode) 58, 238

Soft focus (shooting mode) 62

## Software

Sending images to a computer automatically 171, 262

Sports (shooting mode) 56, 238

Spot AF 107

Strap 22

Style settings 105

## T

Terminal 221, 226, 227

Time-lapse movie (shooting mode) 124, 254

Toy camera effect (shooting mode) 63

Tracking AF 107, 251

Troubleshooting 270

TV display 221, 268

Tv (shooting mode) 68, 241



## V

Video snapshot 122, 253

Video system 194

Viewing 32, 128, 255

    Digest movies 130, 255

    Image search 150, 259

    Index display 131

    Jump display 151

    Magnified display 129, 255

    Single-image display 128

    Slideshow 149, 259

    TV display 221, 268

## W

Water painting effect (shooting mode)

    63

White balance (color) 103, 249

Wi-Fi features 155, 260

Wind filter 118

Wireless features 155, 260, 278

## Z

Zoom 30, 52, 71, 242