

# OG-DANTE-12GAM

12G-SDI Embedder/Disembedder DANTE 32 CH

openGear Card

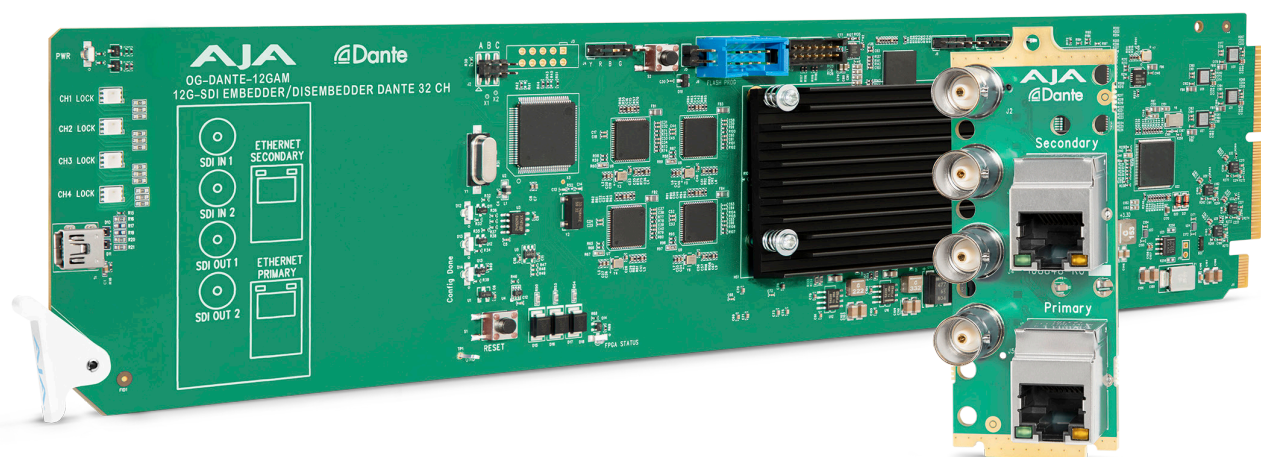

## Installation and Operation Guide

Version 1.1.0

Published September 21, 2020



# Notices

---

## Trademarks

---

AJA® and Because it matters.® are registered trademarks of AJA Video Systems, Inc. for use with most AJA products. AJA™ is a trademark of AJA Video Systems, Inc. for use with recorder, router, software and camera products. Because it matters.™ is a trademark of AJA Video Systems, Inc. for use with camera products.

Corvid Ultra®, Io®, Ki Pro®, KONA®, KUMO®, ROI® and T-Tap® are registered trademarks of AJA Video Systems, Inc.

AJA Control Room™, KiStor™, Science of the Beautiful™, TruScale™, V2Analog™ and V2Digital™ are trademarks of AJA Video Systems, Inc.

All other trademarks are the property of their respective owners.

## Copyright

---

Copyright © 2020 AJA Video Systems, Inc. All rights reserved. All information in this manual is subject to change without notice. No part of the document may be reproduced or transmitted in any form, or by any means, electronic or mechanical, including photocopying or recording, without the express written permission of AJA Video Systems, Inc.

## Contacting AJA Support

---

When calling for support, have all information at hand prior to calling. To contact AJA for sales or support, use any of the following methods:

Telephone	+1.530.271.3190
FAX	+1.530.271.3140
Web	<a href="https://www.aja.com">https://www.aja.com</a>
Support Email	<a href="mailto:support@aja.com">support@aja.com</a>
Sales Email	<a href="mailto:sales@aja.com">sales@aja.com</a>

# Contents

---

- Notices . . . . . 2
  - Trademarks . . . . . 2
  - Copyright . . . . . 2
  - Contacting AJA Support . . . . . 2
  
- Chapter 1 – Introduction . . . . . 4
  - Card Overview . . . . . 4
    - Features . . . . . 5
    - DashBoard for openGear . . . . . 5
    - Dante Applications . . . . . 5
    - OG-DANTE-12GAM Simplified Block Diagram . . . . . 6
  - I/O Connections for OG-DANTE-12GAM . . . . . 6
    - LED Indicators . . . . . 6
    - Signal Indicators in the DashBoard Control System . . . . . 7
  - User Controls . . . . . 9
    - openGear and AJA . . . . . 9
    - DashBoard Control System . . . . . 9
    - Dante Controller . . . . . 9
  - Installation . . . . . 9
    - Summary . . . . . 9
    - Unpacking . . . . . 10
    - Rear OG-DANTE-12GAM Card Installation . . . . . 10
    - Front OG-DANTE-12GAM Card Installation . . . . . 12
    - Cabling . . . . . 13
  
- Chapter 2 – Operation . . . . . 14
  - Using the DashBoard Control System . . . . . 14
    - Requirements . . . . . 14
    - Configuration Settings Stored in OG Card . . . . . 14
    - DashBoard Control Interface Basic Components . . . . . 14
  - Using Dante Controller . . . . . 24
    - Downloading Dante Controller . . . . . 24
    - Learning How To Use Dante Controller . . . . . 24
  
- Appendix A – Specifications . . . . . 27
  
- Appendix B – Safety and Compliance . . . . . 31
  
- Warranty and Liability Information . . . . . 40
  - Limited Warranty on Hardware . . . . . 40
  - Limitation of Liability . . . . . 40
  - Governing Law and Language; Your Rights . . . . . 40
  
- Index . . . . . 42

# Chapter 1 – Introduction

---

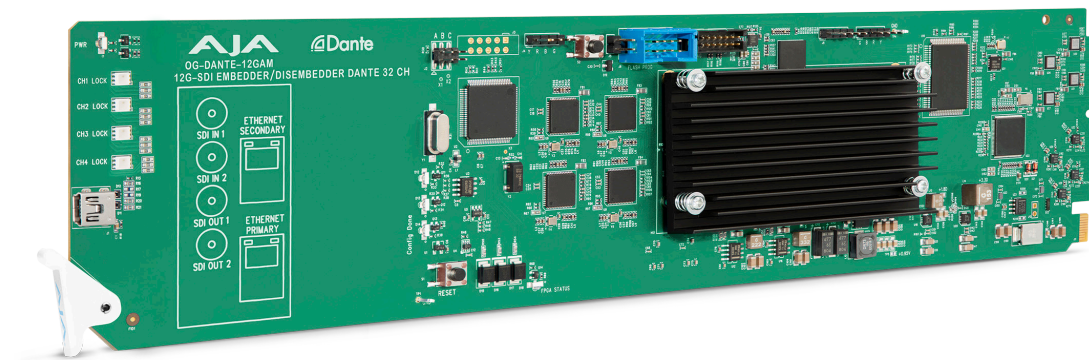

## Card Overview

---

The OG-DANTE-12GAM is a standalone 12G-SDI openGear converter card that routes and receives SDI embedded audio to and from the Dante audio ecosystem. It is ideal for system integrators who wish to handle broadcast audio over SDI with the ability to transport the audio in and out of an Ethernet environment.

The OG-DANTE-12GAM is a dual 12G-SDI, 16-Channel per SDI port (for a total of 32 channels per card) Dante embedder/disembedder with Dashboard support. Dante allows uncompressed, multi-channel, low latency high-resolution digital audio to be distributed across a switched Ethernet network using standard TCP/IP protocols while meeting the stringent quality requirements of professional audio.

The OG-DANTE-12GAM provides a high density method of bridging audio to and from the Dante domain to source and destination equipment containing SDI I/O with embedded audio. When using a single fully-loaded openGear frame, 10 cards can be utilized to allow 640 channels of audio bridging between SDI and Dante.

Dante audio networking provides digital audio distribution over local networking with low latency, using standard network hardware or by connecting into a standard network infrastructure. This offers many advantages, including audio system scalability, easier installation, and simplified wiring.

The OG-DANTE-12GAM automatically detects and configures to the input video standard. 12G-SDI formats up to 4K/UltraHD 60 are supported (see "[OG-DANTE-12GAM Tech Specs](#)" on page 27 for a complete listing). The SDI outputs have minimal video latency and support up to 32 channels of embedded audio.

*NOTE: 2048x1080p/psf 29.97 and 30 formats support a maximum of 8 channels embedded audio.*

## Features

---

- openGear compatible card (requires 2 slots, rear card included)
- Use with openGear OG-3 and OG-X 2RU frames. DFR-8321 frame is not supported.
- Dashboard is used for SDI configuration and status
- Dante Controller is used to route the audio paths. It is also used for all Dante audio network status and configuration.
- Dante support – allows 12G-SDI audio embedding to and from Dante ecosystem
- Dual SDI Channel Support – allows a total of 32 channels (2x 16-Channels)
- 640 Channels available per openGear frame when fully populated with 10x OG-DANTE-12GAM cards
- 12G, 6G, 3G, HD, and SD-SDI embedder/disembedder
- 2x BNC 12G-SDI input
- 2x BNC 12G-SDI output
- 1x Primary and 1x Secondary Gigabit Ethernet ports for Dante network redundancy
- Setup via DashBoard network control software
- Control via a range of Dante Software
- Hot-swap capable
- Five-year warranty

## DashBoard for openGear

---

DashBoard by Ross Video is used to work with openGear cards and frames. Use DashBoard as part of the configuration process of OG-DANTE-12GAM during setup of the system integration.

## Dante Applications

---

In addition to DashBoard, a number of software applications from Audinate are used to work with the Dante ecosystem.

### Dante Controller

---

Dante Controller is the most important Dante application. Dante Controller shows the OG-DANTE-12GAM openGear card as 32 routable audio sources and 32 routable audio destinations. Use this application to set up the audio routing between Dante devices, control the audio connections in the Dante setup, and move audio in real-time over an ethernet network.

### Dante Domain Manager

---

Use Dante Domain Manager to manage the Dante network. It supports setting up authentication, security, and other similar attributes for management of various network architectures.

### Dante Via

---

Use Dante Via to configure audio devices to appear on the Dante network; for example, making the stereo audio portion of U-TAP appear as two audio source channels on the Dante network.

# Dante Updater

Use Dante Updater to update Dante devices on the Dante network. The OG-DANTE-12GAM will be visible in Dante Updater and will be updatable by this application.

## OG-DANTE-12GAM Simplified Block Diagram

Figure 1. OG-DANTE-12GAM Block Diagram

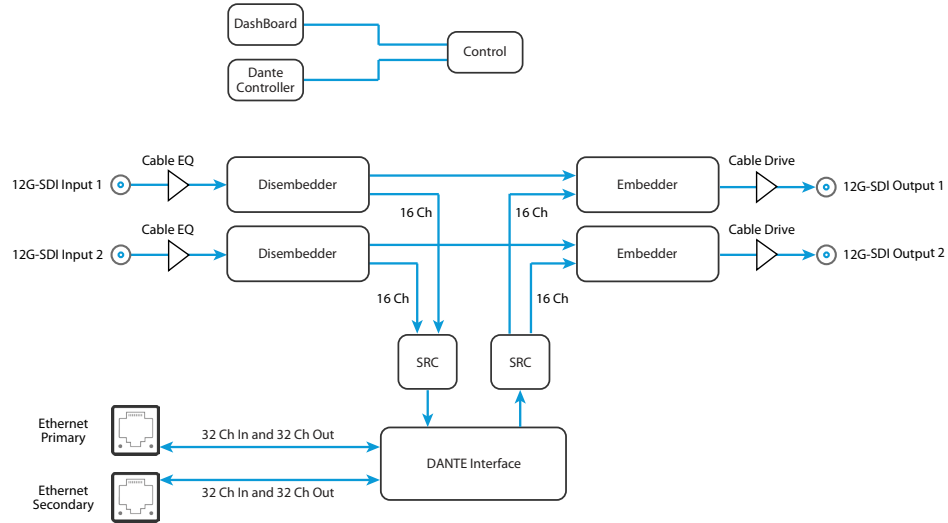

## I/O Connections for OG-DANTE-12GAM

Figure 2. Rear View of OG-DANTE-12GAM Card Connectors

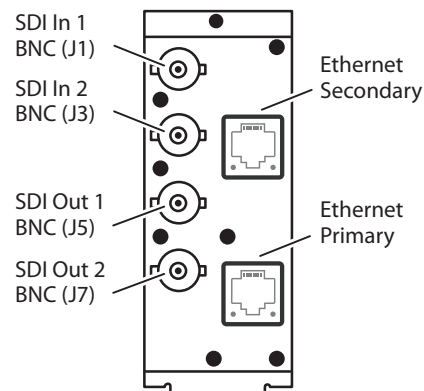

## LED Indicators

LEDs on the front (near door) of the card indicate the presence of power and the type of signal detected on the SDI inputs as follows (from top to bottom):

### Power LED

The Power LED indicates the state of the card as displayed in DashBoard. When power is present, it can be green, yellow or red.

- Green: no DashBoard card state alarm is present.

- Yellow: a yellow DashBoard card state alarm is present. See DashBoard for more information.
- Red: a red DashBoard card state alarm is present. See DashBoard for more information.

### CH1 LOCK LED

The Channel 1 Lock LED will illuminate one of five colors to indicate the input signal type detected:

- Green: SD
- Red: HD
- Amber: 3G
- Purple: 6G
- Blue: 12G

### CH2 LOCK LED

The Channel 2 Lock LED will illuminate one of five colors to indicate the input signal type detected:

- Green: SD
- Red: HD
- Amber: 3G
- Purple: 6G
- Blue: 12G

## Signal Indicators in the DashBoard Control System

### Card Alarm State – Red

This potential card state will result in a red alarm indicator:

- HW Status Unsupported Rear Module

*Figure 3. Card alarm state red*

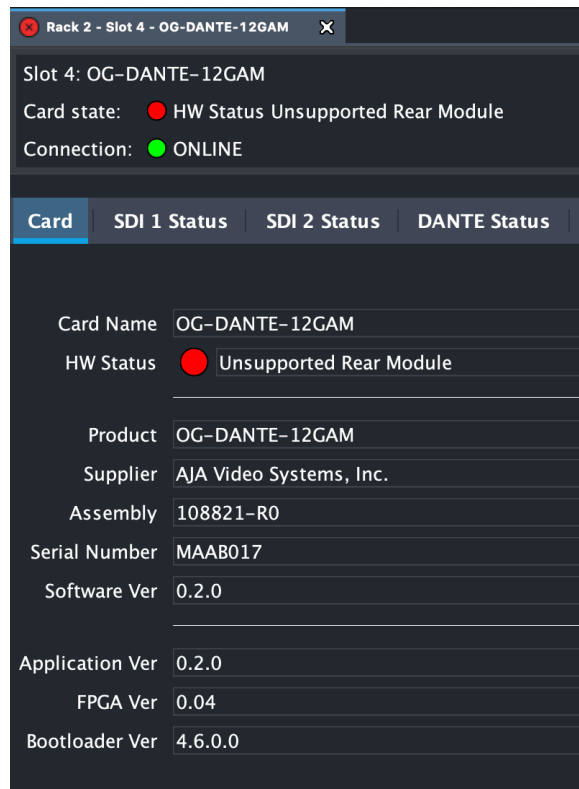

## Card Alarm State – Yellow

When the input signal is not present, the DashBoard Control System shows a yellow Card State alarm; for example, "SDI 2 Not Locked." Additionally, the Input is shown as "No Video."

*Figure 4. Signal not present or not locked*

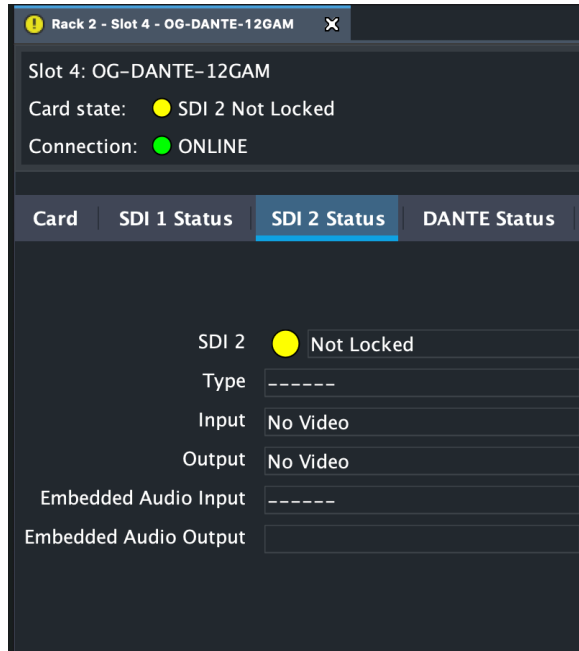

## Card Alarm State – Green

When there is a valid input signal detected, the DashBoard Control System shows a green Card State. Additionally, under the SDI 1 Status tab, the SDI 1 field reports "Locked," and the Input field shows the resolution of the signal detected (for example, "1920x1080p 59.94").

*Figure 5. Signal is present and locked*

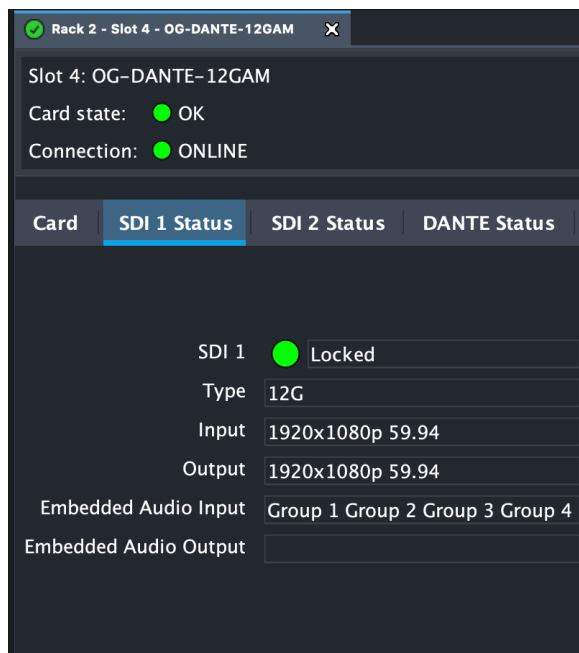



# User Controls

---

The essential user controls for the OG-DANTE-12GAM consist of three components—an openGear 2RU frame, the DashBoard Control System, and Dante Controller.

## openGear and AJA

---

openGear is an open-architecture, modular frame system designed by Ross Video and supported by a diverse range of terminal equipment manufacturers, including AJA. Ross Video manufactures the frames, power supplies and network cards for openGear. AJA is a reseller of the openGear frames.

AJA Video is a leading manufacturer of video interface technologies, converters, digital video recording solutions and professional cameras, bringing high-quality, cost-effective products to the professional, broadcast and post-production markets. AJA products, including openGear cards, are designed and manufactured at our facilities in Grass Valley, California.

## DashBoard Control System

---

The DashBoard Control System, created by Ross Video, provides a control interface between Windows, macOS and Linux computers and the cards installed in an openGear frame. DashBoard operates through TCP/IP communication and requires an Ethernet connection between the controlling computer and an openGear frame.

Use DashBoard to set up which channels are going to be embedded.

For details about acquiring and using the DashBoard Control System, refer to ["Using the DashBoard Control System" on page 14](#).

## Dante Controller

---

Dante Controller is the most important Dante application. Dante Controller shows the OG-DANTE-12GAM openGear card as 32 routable audio sources and 32 routable audio destinations. Use this application to set up the audio routing between Dante devices, control the audio connections in the Dante setup, and move audio in real-time over an ethernet network. Dante Controller is also used for configuring certain network settings and for monitoring network status.

For more information, see ["Using Dante Controller" on page 24](#).

# Installation

---

## Summary

---

**NOTE:** Use with openGear OG-3-FR and OG-X-FR 2RU frames. DFR-8321 frame is not supported.

Installing an OG-DANTE-12GAM card into an OG-X-FR openGear frame consists of the following steps:

- Install the Rear Panel onto the back of the frame corresponding to the slot pair you will be using for the OG-DANTE-12GAM card.
- Insert the OG-DANTE-12GAM card into the frame in the right (even numbered) slot of the pair.

- Connect the BNC cabling to the Rear Panel.
- Connect the Ethernet cabling to the Primary Ethernet.

*NOTE: The Secondary Ethernet port is for redundant network only and must use a separate network switch.*



**ESD Susceptibility** - Static discharge can cause serious damage to sensitive semiconductor devices. Avoid handling circuit boards in high static environments such as carpeted areas, and when wearing synthetic fiber clothing. Always exercise proper grounding precautions when working on circuit boards and related equipment.

## Unpacking

---

Unpack each openGear product you received from the shipping container and ensure that all items are included. If any items are missing or damaged, contact your sales representative or AJA directly.

## Parts List

---

<i>Quantity</i>	<i>Description</i>
1	OG-DANTE-12GAM Front Card in ESD bag
1	4 BNC and 2 Ethernet Port Rear Card

## Rear OG-DANTE-12GAM Card Installation

---

1. Ensure that the frame is properly installed.
2. Locate the card frame slot on the rear of the openGear frame into which you wish to install the openGear card.

*NOTE: An OG-DANTE-12GAM card occupies two slots in the frame.*

3. Using a Phillips screwdriver, unscrew the top screw from the desired blank rear plate and remove the rear plate.
4. Seat the bottom of the Rear Card in the seating slot at the base of the frame back plane.

*Figure 6. Rear Card Inserting Into Frame Seating Slot*

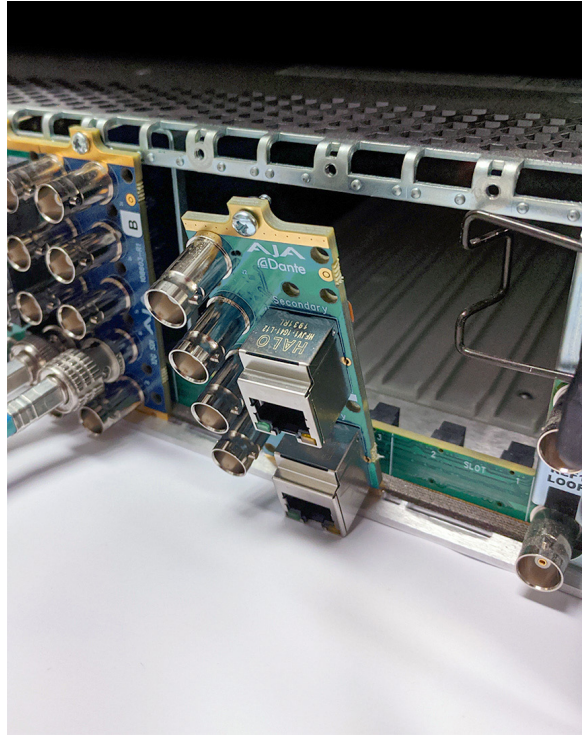

5. Align the top screw of the Rear Card with the screw hole on the top edge of the frame back plane.
6. Ensure the Rear Card aligns with the desired card slot before tightening the screw.
7. Using a Phillips screwdriver, fasten the Rear Card to the frame back plane. Do not over tighten.

*Figure 7. Rear Card Inserted Into Frame Seating Slot*



8. Ensure proper frame cooling and ventilation by having all rear frame slots covered with rear modules or blank metal plates if plates are not pre-installed.

## Front OG-DANTE-12GAM Card Installation

---

1. Open the openGear frame door as follows:
  - A. Gently pull the side door tabs towards the center of the door, releasing the door from the frame.
  - B. Using both hands, pull the door towards you. The door extender arms prevent the door from falling.
2. Locate the Rear Card you installed as described above. The interior slot number is dependent on the slot combinations into which you installed the Rear Card. This allows adequate spacing to avoid damaging the card, the cards installed in the neighboring slots, or both.
3. Hold the card by the edges and carefully align the card edges with the rails inside the frame. The slots are numbered starting from the left-most slot when facing the frame front.

**IMPORTANT:** OG-DANTE-12GAM cards are installed into the right (even numbered) slot of the pair in order to connect with the rear panel.

4. Fully insert the card into the frame until the card is properly seated in the Rear Card. There are two stages to inserting the card:
  - A. After you feel the card's first click, its position in the frame will resemble the photograph below in [Figure 8](#).
  - B. Next, press against the white plastic tab again until you feel the second click. The card's position will resemble the photograph below in [Figure 9](#).

**NOTE:** Some cards require more pressure than others to be fully inserted. Make sure that the plastic tab at the bottom of the front edge of the card is completely upright. If it is tilting forward, the card is not yet fully inserted.

*Figure 8. The card on the left is already fully inserted. The card on the right is not yet fully inserted, as indicated by the white plastic tab tilting forward.*

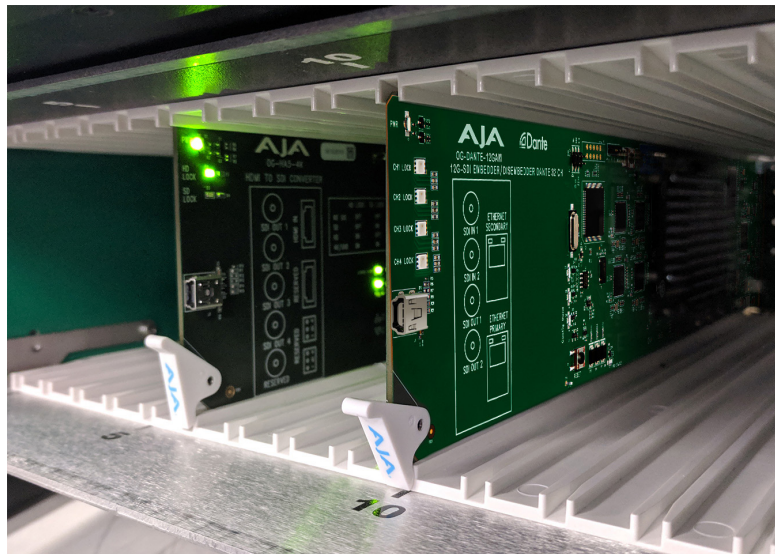

Figure 9. The white plastic tab for the card on the right is now upright. Both cards are shown fully inserted.



5. Close the frame door as follows:
  - A. Slide the door into the frame.
  - B. Pull and release the door tabs to ensure the frame door is securely locked to the frame.

## Cabling

Refer to [Figure 2 on page 6](#) to identify the input and output signal connectors.

After installing the OG-DANTE-12GAM with its rear card into your openGear frame and connecting your SDI inputs and outputs, connect a Cat5 or Cat6 Ethernet cable from your applicable network to the Ethernet Primary port on the rear card.

**NOTE:** *The Ethernet Secondary port is used only for a secondary redundant network connection that must be on a separate network. Dante Controller will not function correctly if the Primary and Secondary Ethernet Ports are connected to the same network switch.*

# Chapter 2 – Operation

---

## Using the DashBoard Control System

---

The DashBoard Control System is available as a free download from the openGear DashBoard Software Download webpage:

<https://www.rossvideo.com/support/software-downloads/dashboard/>

Ross Video offers comprehensive documentation that covers the extensive capabilities of the DashBoard Control System:

<https://www.rossvideo.com/support/product-documentation/dashboard/>

This AJA OG-DANTE-12GAM manual addresses only those essential aspects of the DashBoard Control System needed to control the OG-DANTE-12GAM card.

## Requirements

---

Use the latest available version of DashBoard.

The DashBoard Control System requires the following components:

- openGear frame with a Frame Controller card
- Ethernet connection between the controlling computer and the openGear frame

*NOTE: The openGear frame ships from AJA with the MFC-8322-S Frame Controller card for controlling the new AJA DashBoard cards. The openGear frame also supports the MFC-0G3-N Advanced Networking Frame Controller card, which can be used to control compatible OG cards.*

DashBoard automatically discovers openGear and DashBoard Connect devices, such as openGear frames and cards that are present and accessible on your network.

## Configuration Settings Stored in OG Card

---

Configuration settings made through DashBoard are stored in the OG-DANTE-12GAM unit through subsequent power cycles.

## DashBoard Control Interface Basic Components

---

The basic components of the DashBoard Control System user interface consist of the basic tree view of frames and cards, the card information and status panel, and the parameter controls panel. These elements are shown below.

Figure 10. Main Sections of the DashBoard User Interface

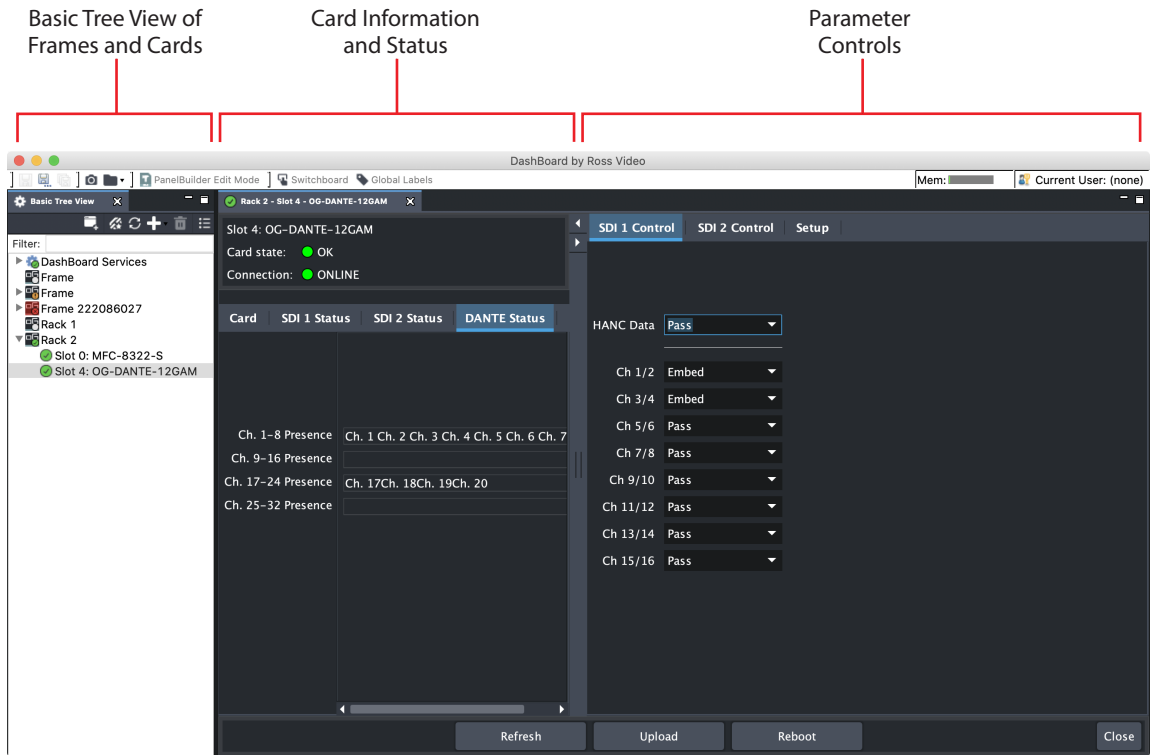

## Basic Tree View of Frames and Cards

The basic tree view in the left column shows the frames and cards that are discoverable by DashBoard on your network.

## Card Information and Status

The card information and status panel, shown in the middle panel, display the basic status of the card currently selected in DashBoard.

## Parameter Controls

The parameter controls panel on the right side of DashBoard shows the tabs and parameters that are configurable for the selected card. The white fields indicate that they can be written to, or modified.

## Card Tab Screen

Figure 11. OG-DANTE-12GAM Card Tab Screen in DashBoard

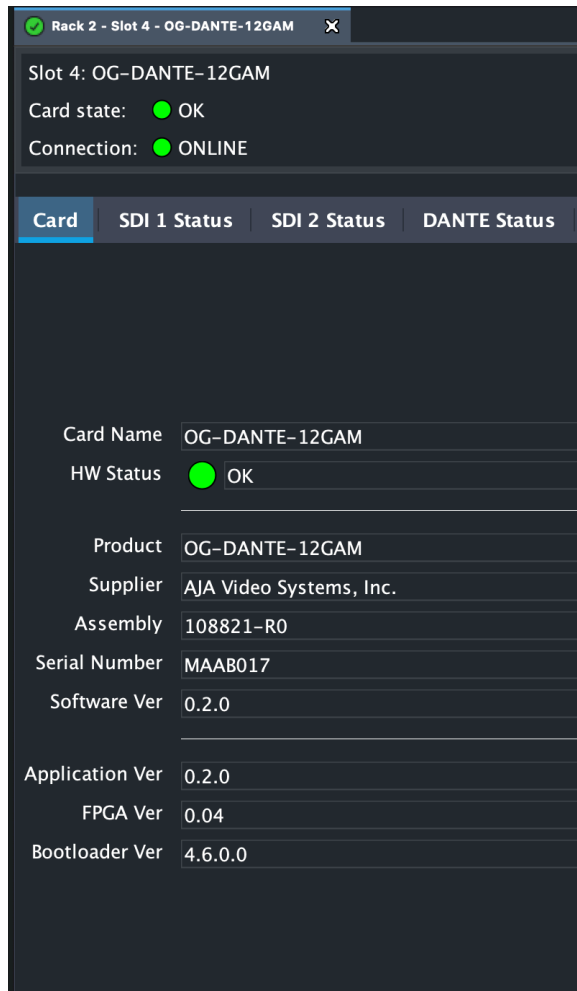

The Card tab screen indicates the basic information about the card itself such as the card name, hardware status, serial number, software version and other items.



## SDI 1 Status Tab Screen

Figure 12. OG-DANTE-12GAM SDI 1 Status Tab Screen in Dashboard

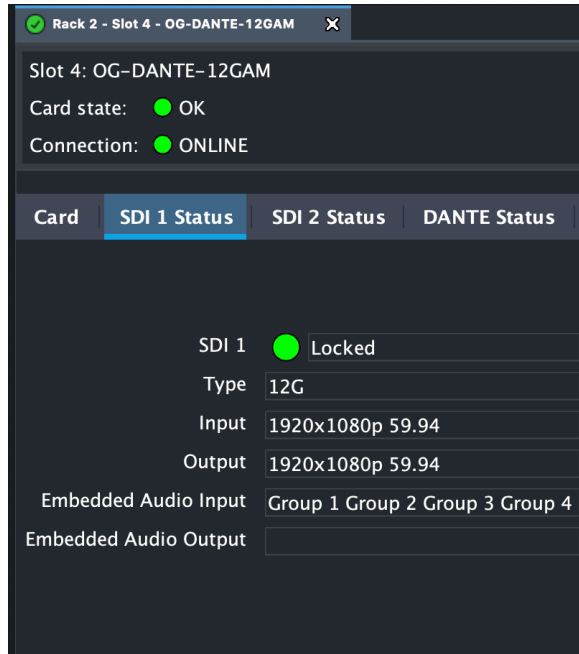

The SDI 1 Status tab screen indicates the status of key aspects of signal presence such as SDI 1 Lock, SDI Signal Type, Input Signal, Output Signal, and which groups are present in the ingoing and outgoing embedded audio.

## SDI 2 Status Tab Screen

Figure 13. OG-DANTE-12GAM SDI 2 Status Tab Screen in Dashboard

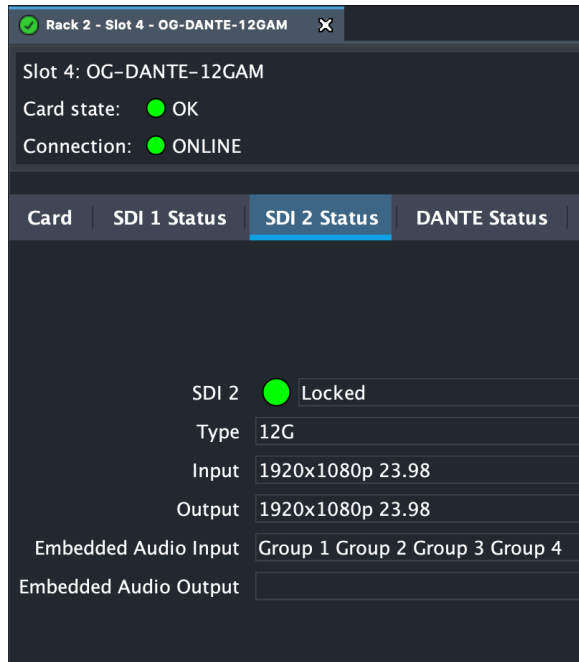

The SDI 2 Status tab screen indicates the status of key aspects of signal presence such as SDI 2 Lock, SDI Signal Type, Input Signal, Output Signal, and which groups are present in the ingoing and outgoing embedded audio.

## DANTE Status Tab Screen

Figure 14. OG-DANTE-12GAM DANTE Status Tab Screen in Dashboard

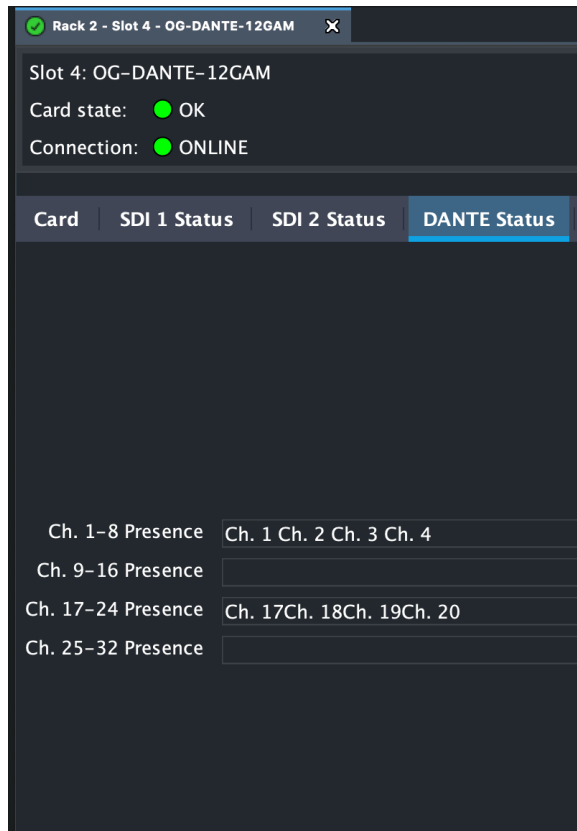

The DANTE Status tab screen indicates what audio channels are being actively routed to the OG-DANTE-12GAM through the Dante network for the following four channel groups:

- Channel 1 - 8
- Channel 9 - 16
- Channel 17 - 24
- Channel 25 - 32

## SDI 1 Control Tab Screen

Figure 15. OG-DANTE-12GAM SDI 1 Control Tab Screen in DashBoard

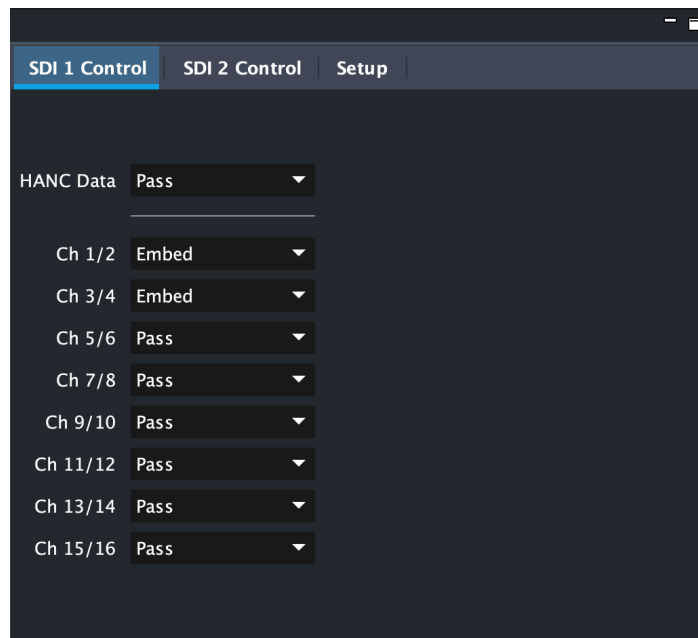

Click on the SDI 1 Control tab to view and make changes to the audio embedding and disembedding settings.

**HANC Data** - When *Pass* is selected, all incoming HANC packets are passed unless the embedder settings require all or part of them to be over-written.

When *Delete* is selected, all incoming HANC packets are dropped before embedding any new audio packets. The embedder settings determine all embedded audio output. Disembedding is not affected.

*NOTE: 2048x1080p/psf 29.97 and 30 formats support a maximum of 8 channels of embedded audio. When one of these formats is present and embedding is turned on, the PASS HANC setting will be ignored and all incoming packets will be dropped before embedding any new audio packets.*

**Audio Channel Pair Pass/Embed** - Choose which SDI audio channels will embed incoming Dante audio channels. When *Pass* is selected, the corresponding incoming and outgoing audio channel pair for SDI 1 remain unchanged.

When *Embed* is selected, the selected channel pair will embed the corresponding incoming Dante channel pair into the outgoing SDI 1 signal.

*NOTE: If a channel is not set up to embed in DashBoard, you can still make the route in Dante Controller but the audio will not be embedded.*

## SDI 2 Control Tab Screen

Figure 16. OG-DANTE-12GAM SDI 2 Control Tab Screen in Dashboard

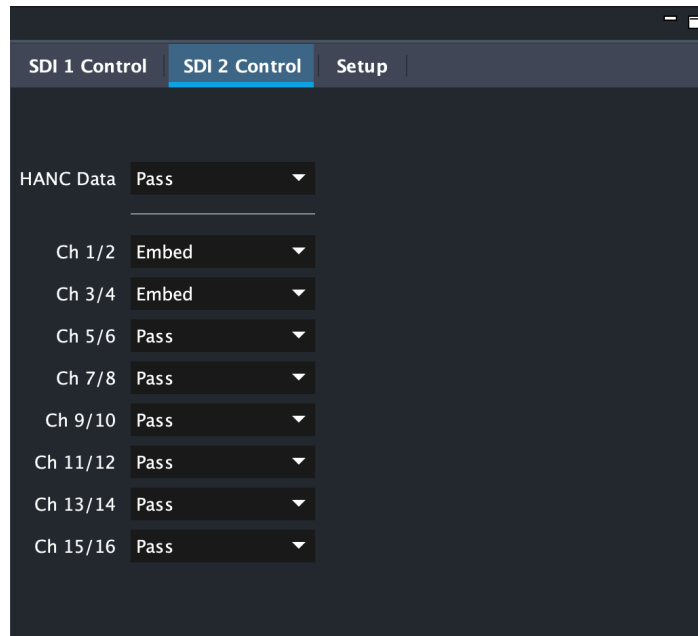

Click on the SDI 2 Control tab to view and make changes to the audio embedding and disembedding settings.

**HANC Data** - When *Pass* is selected, all incoming HANC packets are passed unless the embedder settings require all or part of them to be over-written.

When *Delete* is selected, all incoming HANC packets are dropped before embedding any new audio packets. The embedder settings determine all embedded audio output. Disembedding is not affected.

*NOTE: 2048x1080p/psf 29.97 and 30 formats support a maximum of 8 channels of embedded audio. When one of these formats is present and embedding is turned on, the PASS HANC setting will be ignored and all incoming packets will be dropped before embedding any new audio packets.*

**Audio Channel Pair Pass/Embed** - Choose which SDI audio channels will embed incoming Dante audio channels. When *Pass* is selected, the corresponding incoming and outgoing audio channel pair for SDI 2 remain unchanged.

When *Embed* is selected, the selected channel pair will embed the corresponding incoming Dante channel pair into the outgoing SDI 2 signal.

## Setup Tab Screen

Figure 17. OG-DANTE-12GAM Setup Tab Screen in Dashboard

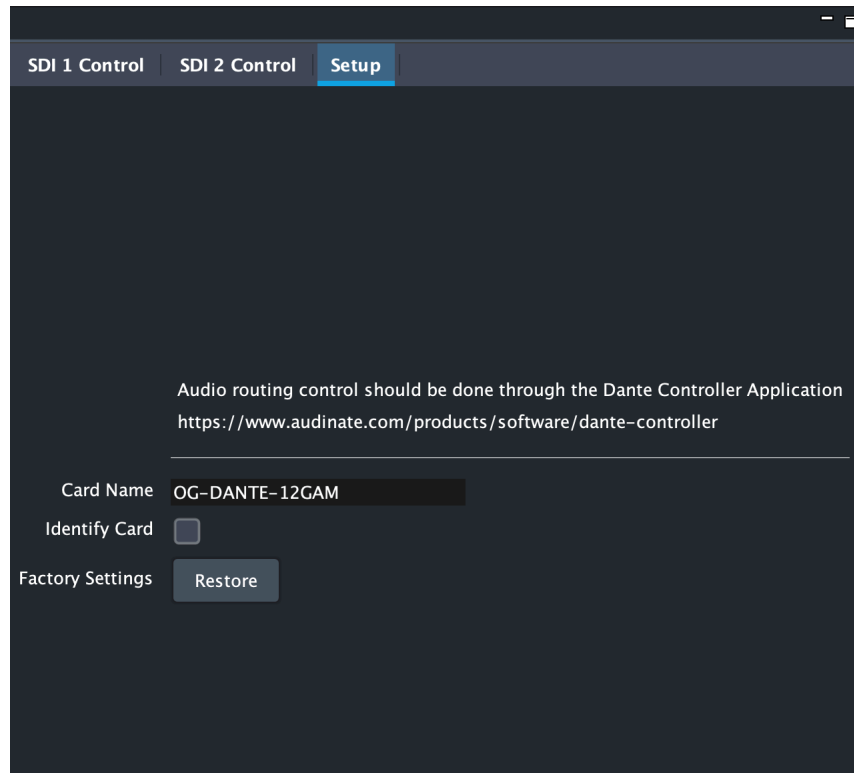

Click on the Setup tab to view and make changes to the card name, to identify the card in the openGear frame, or to restore card settings to factory default values.

**Card Name** - By default, this field is pre-populated with the card name OG-DANTE-12GAM. You can change the card name by editing the text in the Card Name field.

*NOTE:* Changing the Card Name in the Setup tab also changes the name of the card in the Dashboard tree view.

**Identify Card** - Select the checkbox to turn on the Identify Card function. When this function is turned on, an LED light on the front of the OG-DANTE-12GAM card inside the openGear frame will blink to help you quickly identify the card. Open the front of the openGear frame in order to see the light blinking.

**Factory Settings** - If you would like to revert the card settings to factory default values, click **Restore**. A confirmation prompt displays. Select "Yes" to restore factory settings. Select "No" to cancel.

## Uploading New Software and Firmware

### Distinction Between Software and Firmware

Application software uploaded through Dashboard are .bin files, whereas firmware uploads are handled with Dante Firmware Updater and will be .dnt files.

### To Upload New Software

When available, you can upload updated software to the OG-DANTE-12GAM through the Dashboard Control System by following the steps below.

1. Check the AJA website for new software for your OG-DANTE-12GAM. If new software is found, download it and uncompress the file archive (zip).

- Click the Upload button in the lower panel of the DashBoard Control System to open the Upload Software Wizard.

Figure 18. OG-DANTE-12GAM Upload Software Wizard window in DashBoard

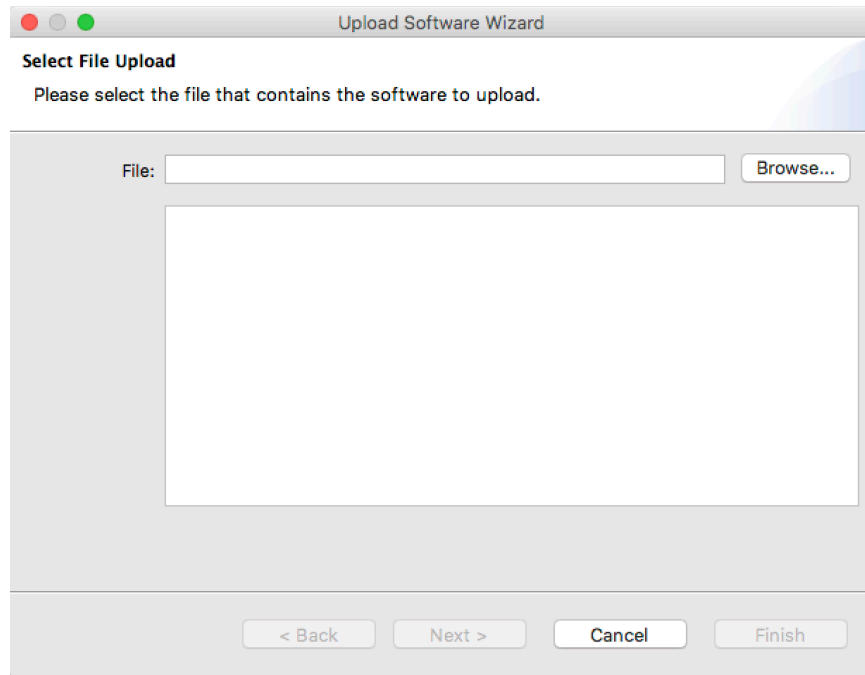

- From the Upload Software Wizard window, select **Browse**.
- Navigate to the location of the downloaded .bin file containing the software update. Select the .bin file, then select **Open**. The Upload Software Wizard window displays characteristics of the selected file for uploading.
- Click **Finish**. The uploading process begins.

Figure 19. OG-DANTE-12GAM Uploading to Selected Devices window in DashBoard

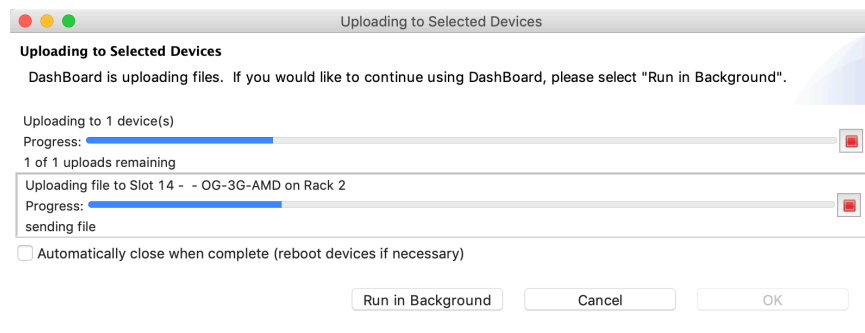

- When the progress bar indicates that the uploading is finished and status indicates "Complete," click **OK**.
- To verify the version of software or firmware currently installed on your card, select the Card tab from the center panel of DashBoard.

Figure 20. OG-DANTE-12GAM Card Tab Screen in DashBoard indicating the currently installed software version.

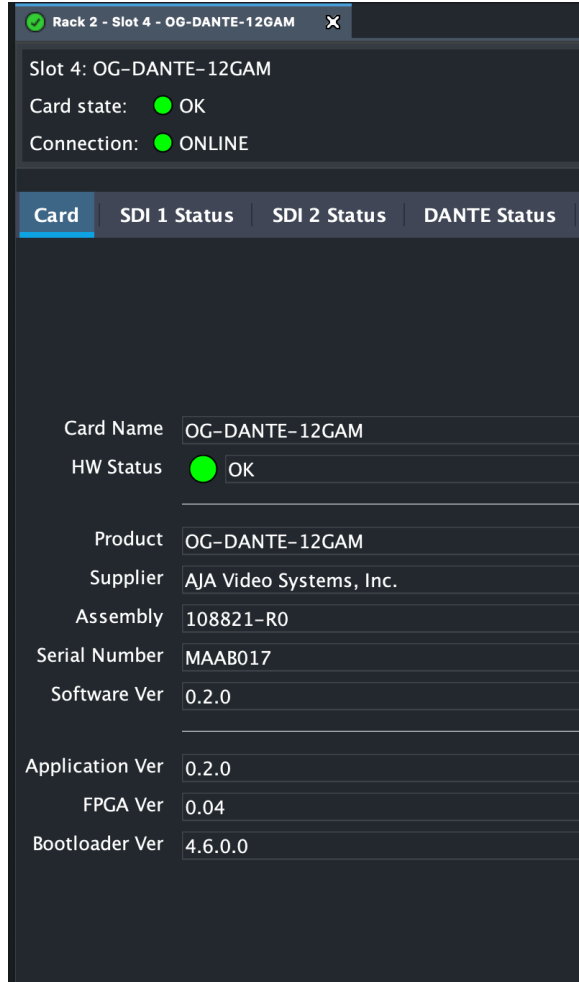

## Rebooting

Rebooting is a standard function built in to the DashBoard Control System, and should only be performed if the board has become unresponsive.

**WARNING:** During a reboot, any card operations will be briefly interrupted, but will be restored once the reboot has completed.

To Reboot the OG-DANTE-12GAM

1. Click the Reboot button in the lower panel of DashBoard. The reboot confirmation message displays.

Figure 21. Reboot confirmation window

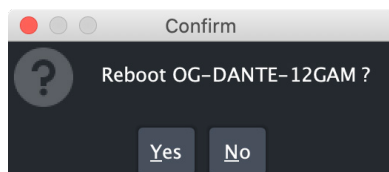

2. Click **Yes**. The message "Loading data, please wait. Refreshing device data" displays for a moment. The card will be offline for a few seconds, and any current operations will be interrupted.

Figure 22. The OG-DANTE-12GAM briefly pauses operations while rebooting

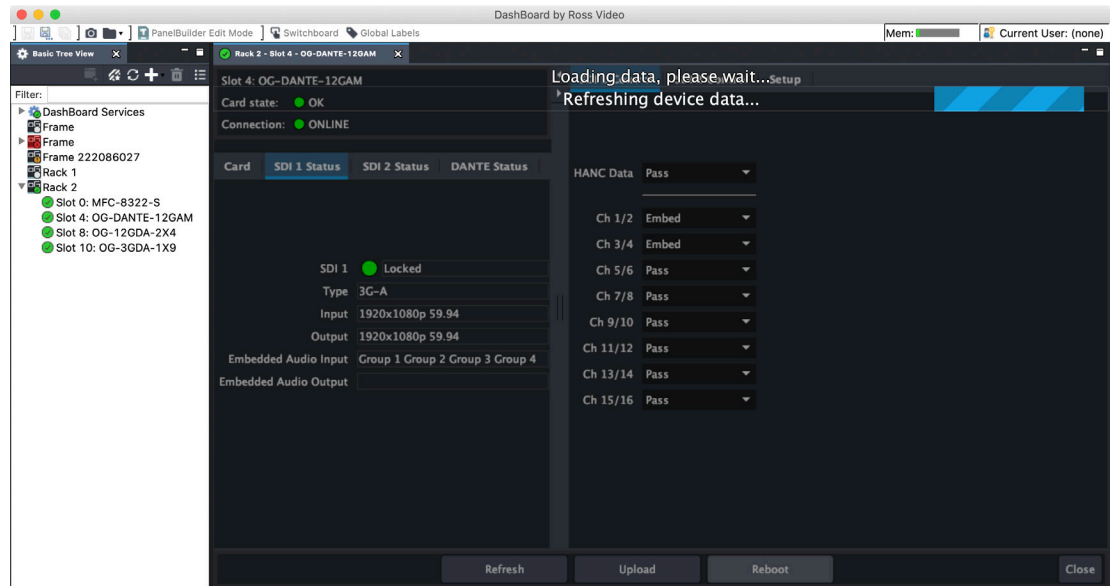

3. Following a Reboot operation, the board configuration will return to the settings that were in place at the time of rebooting.

## Using Dante Controller

After installing the OG-DANTE-12GAM with its rear card into your openGear frame and connecting your SDI inputs and outputs, connect a Cat5 or Cat6 Ethernet cable from your applicable network to the Ethernet Primary port on the rear card.

*NOTE: The Ethernet Secondary port is used only for a secondary redundant network connection that must be on a separate network. Dante Controller will not function correctly if the Primary and Secondary Ethernet Ports are connected to the same network switch.*

## Downloading Dante Controller

Dante Controller is available as a free download from the Audinate website:

<https://www.audinate.com/products/software/dante-controller>

## Learning How To Use Dante Controller

Audinate offers comprehensive training videos that cover the extensive capabilities of the Dante Controller:

The video series "Getting Started with Dante" provides a high-level overview of Dante audio networking. Please refer to these videos to learn how to setup and use a Dante system:

<https://www.audinate.com/learning/training-certification/video-tutorials/video-series-getting-started-with-dante-audio-networking-training>

In addition, Audinate offers another video series, "Dante Controller 101," that goes over the essential functions and features of Dante Controller:

<https://www.audinate.com/learning/training-certification/video-tutorials/video-series-dante-controller-101>



Figure 23. A Basic View of Dante Controller

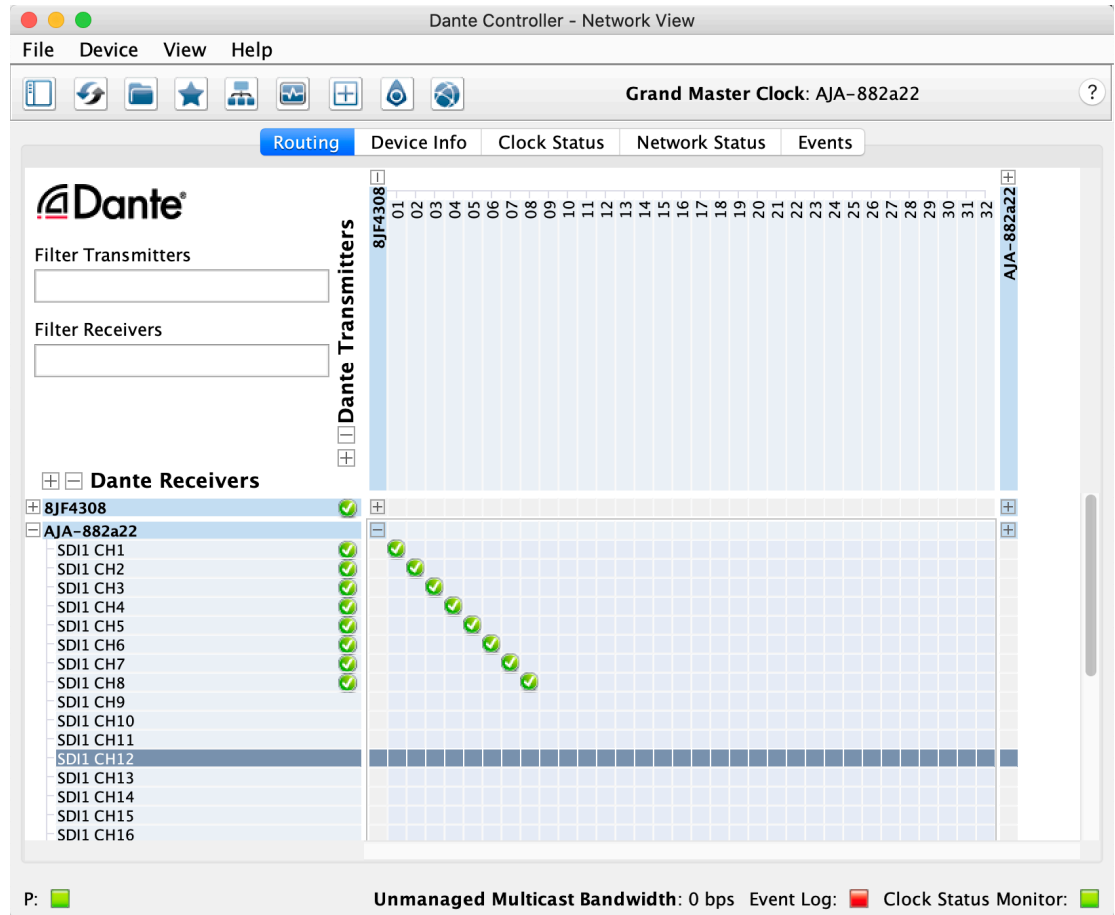

## Updating Dante Devices

Use Dante Updater to update Dante devices on the Dante network. The OG-DANTE-12GAM will be visible in Dante Updater and will be updatable by this application.

### Distinction Between Software and Firmware

Dante firmware updates are independent of the OG software updates.

Application software uploaded through DashBoard are .bin files, whereas firmware uploads are handled with Dante Firmware Updater and will be .dnt files.

### To Access Dante Updater

1. Launch Dante Controller.
2. From the View menu, select Dante Updater. The Dante Updater window launches.

Figure 24. Accessing Dante Updater

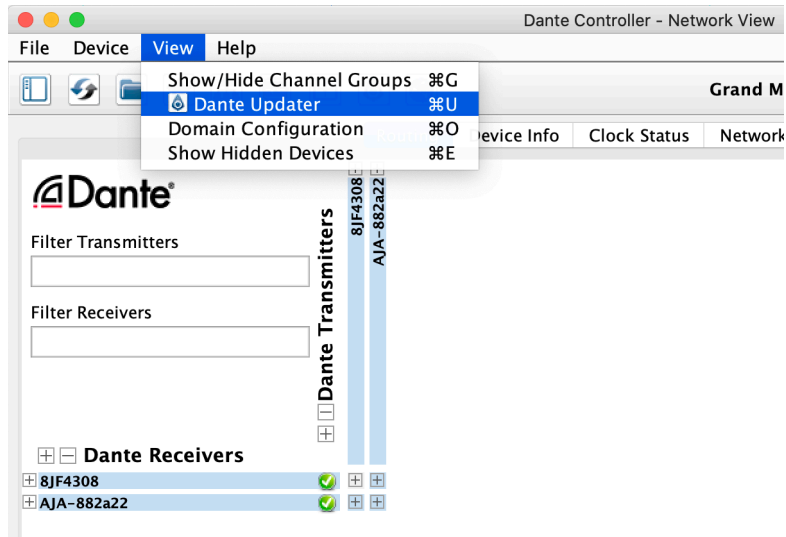

3. Locate and select your device under the Update(s) Available heading.

Figure 25. The Dante Updater Window

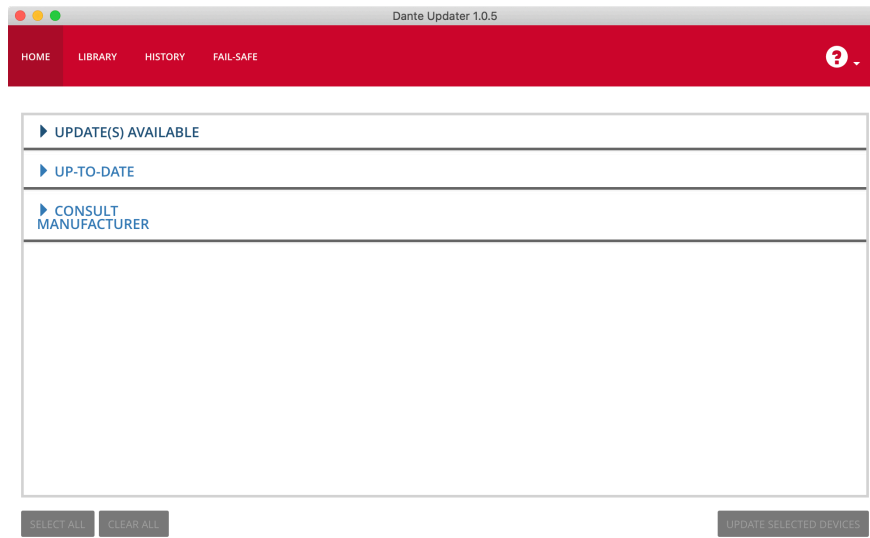

4. With your device selected, click Update Selected Devices. Your device will be updated automatically.

# Appendix A – Specifications

---

## OG-DANTE-12GAM Tech Specs

---

### Video Formats

---

- (4K) 4096x2160p 23.98, 24, 25, 29.97, 30, 50, 59.94, 60
- (UltraHD) 3840x2160p 23.98, 24, 25, 29.97, 30, 50, 59.94, 60
- (2K) 2048x1080p 23.98, 24, 25, 29.97, 30, 50, 59.94, 60
- (HD) 1920x1080p 23.98, 24, 25, 29.97, 30, 50, 59.94, 60
- (HD) 1920x1080i 50, 59.94, 60
- (HD) 1280x720p 50, 59.94, 60
- (SD) 625i 50
- (SD) 525i 59.94
- RGB and YCbCr, 4:4:4/2:2, 10-bit

*NOTE: Raster and frame rate dependent, please see OG-DANTE-12GAM Video Formats below.*

### Video Input Digital

---

- 2-channel independent 12G-SDI BNC connectors, SMPTE 259/292/424/2081/2082
- Single Link SD/HD/2K/UltraHD/4K

### Video Output Digital

---

- 2-channel independent 12G-SDI BNC connectors, SMPTE 259/292/424/2081/2082
- Single Link SD/HD/2K/UltraHD/4K

### Cable Equalization

---

(Belden 1694A coax)

- 12 Gbps, 65m
- 6 Gbps, 120m
- 3 Gbps, 180m
- 1.5 Gbps, 200m
- 270 Mbps, 405m

### Video Path Delay

---

Video Out is a delayed, reclocked version of Video In, at the same format and frame rate. Video Out is undefined when no input.

- Video Latency, time measured between video input and video output connector:
  - 12G = 3.2  $\mu$ sec
  - 6G = 3.2  $\mu$ sec
  - 3G level B-DL = 6.3  $\mu$ sec
  - 3G level A = 3.2  $\mu$ sec
  - HD (1.5 Gb) = 6.3  $\mu$ sec
  - SD (270 Mb) = 17.2  $\mu$ sec

### Audio Input Digital

---

- SDI: Two independent 12G-SDI BNC connectors, 16 embedded channels each
- Dante: 1x Primary Ethernet port and 1x Secondary Ethernet port, 32-channels

## Audio Output Digital

---

- SDI: Two independent 12G-SDI BNC connectors, 16 embedded channels each
- Dante: 1x Primary and 1x Secondary Gigabit Ethernet ports, 32-channels

## SDI Embedded Audio

---

- SMPTE 299M (12G/6G/3G/1.5G): 24-bit, 48 kHz synchronous
- SMPTE 272M (SD): 20-bit, 48 kHz synchronous
- Incoming embedded audio can be passed, removed, or overridden
- 4 groups (16-channels) of audio supported per SDI path

*NOTE: 2048x1080p/PsF 29.97 and 30 formats support a maximum of 8-channels embedded audio.*

## Dante Audio

---

- Sample Rates: 44.1kHz, 48kHz, 88.2kHz, 96kHz
- Encoding: PCM 16, PCM 24, PCM 32

## Audio Latency

---

- Embed Path        1500 µsec
- Disembed Path    1410 µsec

## User Interface

---

- openGear DashBoard network control software via Windows, macOS or Linux
- Dante Controller

## Size

---

- openGear standard form factor, front slot and rear card. Two slots required for each card.

## Weight

---

- 0.5 lb (0.3 kg)

## Power

---

- openGear frame compatible, 15 watts max per card

## Environment

---

- Safe Operating Temperature: 0 to 40 C (32 to 104 F)
- Safe Storage Temperature (Power OFF): -40 to 60 C (-40 to 140 F)
- Operating Relative Humidity: 10-90% noncondensing
- Operating Altitude: <3,000 meters (<10,000 feet)

## OG-Dante-12GAM Video I/O Formats

### 4K/UltraHD Inputs Supported

#### 1x 12Gb SDI:

<u>Format</u>	<u>Frame Rate</u>	<u>Colorspace</u>	<u>Sampling</u>	<u>Bit Depth</u>
• 3840x2160p	23.98, 24, 25, 29.97, 30	YCbCr/RGB	4:4:4	10
• 3840x2160p	50, 59.94, 60	YCbCr	4:2:2	10
• 4096x2160p	23.98, 24, 25, 29.97, 30	YCbCr/RGB	4:4:4	10
• 4096x2160p	50, 59.94, 60	YCbCr	4:2:2	10

#### 1x 6Gb SDI:

<u>Format</u>	<u>Frame Rate</u>	<u>Colorspace</u>	<u>Sampling</u>	<u>Bit Depth</u>
• 3840x2160p	23.98, 24, 25, 29.97, 30	YCbCr	4:2:2	10
• 4096x2160p	23.98, 24, 25, 29.97, 30	YCbCr	4:2:2	10

### 2K/HD Inputs Supported

#### 1x 3Gb SDI:

<u>Format</u>	<u>Frame Rate</u>	<u>Level A/B</u>	<u>Colorspace</u>	<u>Sampling</u>	<u>Bit Depth</u>
• 1280x720p	50, 59.94, 60	A	YCbCr/RGB	4:4:4	10
• 1920x1080i	50, 59.94, 60	A or B-DL	YCbCr/RGB	4:4:4	10
• 1920x1080p	23.98, 24, 25, 29.97, 30	A or B-DL	YCbCr/RGB	4:4:4	10
• 1920x1080p	50, 59.94, 60	A or B-DL	YCbCr	4:2:2	10
• 1920x1080PsF	23.98, 24, 25, 29.97, 30	A or B-DL	YCbCr/RGB	4:4:4	10
• 2048x1080p	23.98, 24, 25, 29.97, 30	A or B-DL	YCbCr/RGB	4:4:4	10
• 2048x1080p	50, 59.94, 60	A or B-DL	YCbCr	4:2:2	10
• 2048x1080PsF	23.98, 24, 25, 29.97, 30	A or B-DL	YCbCr/RGB	4:4:4	10

#### 1x 1.5Gb SDI:

<u>Format</u>	<u>Frame Rate</u>	<u>Colorspace</u>	<u>Sampling</u>	<u>Bit Depth</u>
• 1280x720p	50, 59.94, 60	YCbCr	4:2:2	10
• 1920x1080i	50, 59.94, 60	YCbCr	4:2:2	10
• 1920x1080p	23.98, 24, 25, 29.97, 30	YCbCr	4:2:2	10
• 1920x1080PsF	23.98, 24, 25, 29.97, 30	YCbCr	4:2:2	10



• 2048x1080p	23.98, 24, 25, 29.97, 30	YCbCr	4:2:2	10
• 2048x1080PsF	23.98, 24, 25, 29.97, 30	YCbCr	4:2:2	10

### SD Inputs Supported

**1x 270Mb SDI:**

<u>Format</u>	<u>Frame Rate</u>	<u>Colorspace</u>	<u>Sampling</u>	<u>Bit Depth</u>
• 525i	59.94	YCbCr	4:2:2	10
• 625i	50	YCbCr	4:2:2	10

# Appendix B – Safety and Compliance

---

## Federal Communications Commission (FCC) Compliance Notices

---

### Class A Interference Statement

---

This equipment has been tested and found to comply with the limits for a Class A digital device, pursuant to Part 15, Subpart B of the FCC Rules. These limits are designed to provide reasonable protection against harmful interference in a residential installation. This equipment generates, uses, and can radiate radio frequency energy and, if not installed and used in accordance with the instructions, may cause harmful interference to radio communications. However, there is no guarantee that interference will not occur in a particular installation. If this equipment does cause harmful interference to radio or television reception, which can be determined by turning the equipment off and on, the user is encouraged to try to correct the interference by one or more of the following measures:

- Reorient or relocate the receiving antenna.
- Increase the separation between the equipment and receiver.
- Connect the equipment into an outlet on a circuit different from that to which the receiver is connected.
- Consult the dealer or an experienced radio/TV technician for help.

### FCC Caution

---

This device complies with Part 15 of the FCC Rules. Operation is subject to the following two conditions: (1) This device may not cause harmful interference, and (2) this device must accept any interference received, including interference that may cause undesired operation.

## Canadian ICES Statement

---

### Canadian Department of Communications Radio Interference Regulations

This digital apparatus does not exceed the Class A limits for radio-noise emissions from a digital apparatus as set out in the Radio Interference Regulations of the Canadian Department of Communications. This Class A digital apparatus complies with Canadian ICES-003.

### Règlement sur le brouillage radioélectrique du ministère des Communications

Cet appareil numérique respecte les limites de bruits radioélectriques visant les appareils numériques de classe A prescrites dans le Règlement sur le brouillage radioélectrique du ministère des Communications du Canada. Cet appareil numérique de la Classe A est conforme à la norme NMB-003 du Canada.

## European Union and European Free Trade Association (EFTA) Regulatory Compliance

---

This equipment may be operated in the countries that comprise the member countries of the European Union and the European Free Trade Association. These countries, listed in the following paragraph, are referred to as The European Community throughout this document:

AUSTRIA, BELGIUM, BULGARIA, CYPRUS, CZECH REPUBLIC, DENMARK, ESTONIA, FINLAND, FRANCE, GERMANY, GREECE, HUNGARY, IRELAND, ITALY, LATVIA, LITHUANIA, LUXEMBOURG, MALTA, NETHERLANDS, POLAND, PORTUGAL, ROMANIA, SLOVAKIA, SLOVENIA, SPAIN, SWEDEN, UNITED KINGDOM, ICELAND, LICHTENSTEIN, NORWAY, SWITZERLAND

## Declaration of Conformity

Marking by this symbol indicates compliance with the Essential Requirements of the EMC Directive of the European Union 2014/30/EU.



This equipment meets the following conformance standards:

### Safety

EN 60065: 2014 (T-Mark License),  
IEC 60065: 2014 (CB Scheme Report/Certificate)  
EN 62368-1: 2014 + A11 (T-Mark License)  
IEC 62368-1: 2014 (CB Scheme Certificate)

Additional licenses issued for specific countries available on request.

### Emissions

EN 55032: 2012 + AC: 2013, CISPR 32: 2015, EN 61000-3-2: 2014, EN 61000-3-3: 2013

### Immunity

EN 55103-2: 2009, EN 61000-4-2: 2009, EN 61000-4-3: 2006+ A1: 2008 + A2: 2010,  
EN 61000-4-4: 2012, EN 61000-4-5: 2014/A1: 2017, EN 61000-4-6: 2013,  
EN 61000-4-11: 2020

Environments: E2, E3 and E4

The product is also licensed for additional country specific standards as required for the International Marketplace



**Warning!** This is a Class A product. In a domestic environment, this product may cause radio interference, in which case, the user may be required to take appropriate measures.

**Achtung!** Dieses ist ein Gerät der Funkstörgrenzwertklasse A. In Wohnbereichen können bei Betrieb dieses Gerätes Rundfunkstörungen auftreten, in welchen Fällen der Benutzer für entsprechende Gegenmaßnahmen verantwortlich ist.

**Attention!** Ceci est un produit de Classe A. Dans un environnement domestique, ce produit risque de créer des interférences radioélectriques, il appartiendra alors à l'utilisateur de prendre les mesures spécifiques appropriées..

## Recycling Notice



This symbol on the product or its packaging indicates that this product must not be disposed of with your other household waste. Instead, it is your responsibility to dispose of your waste equipment by handing it over to a designated collection point for the recycling of waste electrical and electronic equipment. The separate collection and recycling of your waste equipment at the time of disposal will help conserve natural resources and ensure that it is recycled in a manner that protects human health and the environment. For more information about where you can drop off your waste for recycling, please contact your local authority, or where you purchased your product.

## Korea KCC Compliance Statement

### 사용자 안내문

이 기기는 업무용 환경에서 사용할 목적으로 적합성평가를 받은 기기로서 가정용 환경에서 사용하는 경우 전파간섭의 우려가 있습니다.



## Taiwan Compliance Statement

警告使用者：  
這是甲類的資訊產品，在居住的環境中使用時，可能會造成射頻干擾，在這種情況下，使用者會被要求採取某些適當的對策。

This is a Class A product based on the standard of the Bureau of Standards, Metrology and Inspection (BSMI) CNS 13438, Class A. In a domestic environment this product may cause radio interference in which case the user may be required to take adequate measures.

## Japanese Compliance Statement

この装置は、クラスA情報技術装置です。この装置を家庭環境で使用すると電波妨害を引き起こすことがあります。この場合には使用者が適切な対策を講ずるよう要求されることがあります。 VCCI-A

This is a Class A product based on the standard of the VCCI Council (VCCI 32: 2016). If this equipment is used in a domestic environment, radio interference may occur, in which case, the user may be required to take corrective actions.

## Translated Warning and Caution Messages

The following caution statements, warning conventions, and warning messages apply to this product and manual.



Warning Symbol



Hazard Symbol



Caution Symbol

## Before Operation Please Read These Instructions



**Warning!** Read and follow all warning notices and instructions marked on the product or included in the documentation.

**Avertissement!** Lisez et conformez-vous à tous les avis et instructions d'avertissement indiqués sur le produit ou dans la documentation.

**Warnung!** Lesen und befolgen Sie die Warnhinweise und Anweisungen, die auf dem Produkt angebracht oder in der Dokumentation enthalten sind.

**¡Advertencia!** Lea y siga todas las instrucciones y advertencias marcadas en el producto o incluidas en la documentación.

**Aviso!** Leia e siga todos os avisos e instruções assinalados no produto ou incluídos na documentação.

**Avviso!** Leggere e seguire tutti gli avvisi e le istruzioni presenti sul prodotto o inclusi nella documentazione.



**Warning!** Do not use this device near water and clean only with a dry cloth.

**Avertissement!** N'utilisez pas cet appareil près de l'eau et nettoyez-le seulement avec un tissu sec.

**Warnung!** Das Gerät nicht in der Nähe von Wasser verwenden und nur mit einem trockenen Tuch säubern.

**¡Advertencia!** No utilice este dispositivo cerca del agua y límpielo solamente con un paño seco.

**Aviso!** Não utilize este dispositivo perto da água e limpe-o somente com um pano seco.

**Avviso!** Non utilizzare questo dispositivo vicino all'acqua e pulirlo soltanto con un panno asciutto.



**Warning!** Do not block any ventilation openings. Install in accordance with the manufacturer's instructions.

**Avertissement!** Ne bloquez aucune ouverture de ventilation. Suivez les instructions du fabricant lors de l'installation.

**Warnung!** Die Lüftungsöffnungen dürfen nicht blockiert werden. Nur gemäß den Anweisungen des Herstellers installieren.

**¡Advertencia!** No bloquee ninguna de las aberturas de la ventilación. Instale de acuerdo con las instrucciones del fabricante.

**Aviso!** Não obstrua nenhuma das aberturas de ventilação. Instale de acordo com as instruções do fabricante.

**Avviso!** Non ostruire le aperture di ventilazione. Installare in conformità con le istruzioni del fornitore.



**Warning!** Do not install near any heat sources such as radiators, heat registers, stoves, or other apparatus (including amplifiers) that produce heat.

**Avertissement!** N'installez pas l'appareil près d'une source de chaleur telle que des radiateurs, des bouches d'air de chauffage, des fourneaux ou d'autres appareils (amplificateurs compris) qui produisent de la chaleur.

**Warnung!** Nicht in der Nähe von Wärmequellen wie Heizkörpern, Heizregistern, Öfen oder anderen Wärme erzeugenden Geräten (einschließlich Verstärkern) aufstellen.

**¡Advertencia!** No instale cerca de fuentes de calor tales como radiadores, registros de calor, estufas u otros aparatos (incluidos amplificadores) que generan calor.

**Aviso!** Não instale perto de nenhuma fonte de calor tal como radiadores, saídas de calor, fogões ou outros aparelhos (incluindo amplificadores) que produzam calor.

**Avviso!** Non installare vicino a fonti di calore come termosifoni, diffusori di aria calda, stufe o altri apparecchi (amplificatori compresi) che emettono calore



**Warning!** Refer all servicing to qualified service personnel. Servicing is required when the device has been damaged in any way, such as power-supply cord or plug is damaged, liquid has been spilled or objects have fallen into the device, the device has been exposed to rain or moisture, does not operate normally, or has been dropped.

**Avertissement!** Référez-vous au personnel de service qualifié pour tout entretien. L'entretien est exigé quand l'appareil a été endommagé de quelque manière que ce soit, par exemple lorsque le cordon d'alimentation ou la prise sont endommagés, que du liquide a été versé ou des objets sont tombés dans l'appareil, que l'appareil a été exposé à la pluie ou à l'humidité, ne fonctionne pas normalement ou est tombé.

**Warnung!** Das Gerät sollte nur von qualifizierten Fachkräften gewartet werden. Eine Wartung ist fällig, wenn das Gerät in irgendeiner Weise beschädigt wurde, wie bei beschädigtem Netzkabel oder Netzstecker, falls Flüssigkeiten oder Objekte in das Gerät gelangen, das Gerät Regen oder Feuchtigkeit ausgesetzt wurde, nicht ordnungsgemäß funktioniert oder fallen gelassen wurde.

**¡Advertencia!** Consulte al personal calificado por cuestiones de reparación. El servicio de reparación se requiere cuando el dispositivo ha recibido cualquier tipo de daño, por ejemplo cable o espigas dañadas, se ha derramado líquido o se han caído objetos dentro del dispositivo, el dispositivo ha sido expuesto a la lluvia o humedad, o no funciona de modo normal, o se ha caído.

**Aviso!** Remeta todos os serviços de manutenção para o pessoal de assistência qualificado. A prestação de serviços de manutenção é exigida quando o dispositivo foi danificado mediante qualquer forma, como um cabo de alimentação ou ficha que se encontra danificado/a, quando foi derramado líquido ou caíram objectos sobre o dispositivo, quando o dispositivo foi exposto à chuva ou à humidade, quando não funciona normalmente ou quando foi deixado cair.

**Avviso!** Fare riferimento al personale qualificato per tutti gli interventi di assistenza. L'assistenza è necessaria quando il dispositivo è stato danneggiato in qualche modo, ad esempio se il cavo di alimentazione o la spina sono danneggiati, è stato rovesciato del liquido è stato rovesciato o qualche oggetto è caduto nel dispositivo, il dispositivo è stato esposto a pioggia o umidità, non funziona correttamente o è caduto



**Warning!** Disconnect the external AC power supply line cord(s) from the mains power before moving the unit.

**Avertissement!** Retirez le ou les cordons d'alimentation en CA de la source d'alimentation principale lorsque vous déplacez l'appareil.

**Warnung!** Trennen Sie die Wechselstrom-Versorgungskabel vom Netzstrom, bevor Sie das Gerät verschieben.

**¡Advertencia!** Cuando mueva la unidad desenchufe de la red eléctrica el/los cable(s) de la fuente de alimentación CA tipo brick.

**Advertência!** Remova os cabos CA de alimentação brick da rede elétrica ao mover a unidade.

**Avvertenza!** Scollegare il cavo dell'alimentatore quando si sposta l'unità.



**Hazard!** High Voltage. This situation or condition can cause injury due to electric shock.

**Avertissement!** Tension élevée. Cette situation ou condition peut causer des blessures dues à un choc électrique.

**Warnung!** Hochspannung. Diese Situation oder Bedingung kann zu Verletzungen durch Stromschlag führen.

**¡Advertencia!** Alto voltaje . Esta situación o condición puede causar lesiones debidas a una descarga eléctrica.

**Aviso!** Alta Tensão . Esta situação ou condição pode causar danos devido a choques elétricos.

**Avviso!** Alta tensione. Questa situazione o condizione può causare lesioni a causa di scosse elettriche.



**Warning!** Only use attachments and accessories specified and/or sold by the manufacturer.

**Avertissement!** Utilisez seulement les attaches et accessoires spécifiés et/ou vendus par le fabricant.

**Warnung!** Verwenden Sie nur Zusatzgeräte und Zubehör angegeben und / oder verkauft wurde durch den Hersteller.

**¡Advertencia!** Utilice solamente los accesorios y conexiones especificados y/o vendidos por el fabricante.

**Aviso!** Utilize apenas equipamentos/acessórios especificados e/ou vendidos pelo fabricante.

**Avviso!** Utilizzare soltanto i collegamenti e gli accessori specificati e/o venduti dal produttore.



**Warning!** Do not defeat the safety purpose of the polarized or grounding-type plug. A polarized plug has two blades with one wider than the other. A grounding type plug has two blades and a third grounding prong. The wide blade or the third prong are provided for your safety. If the provided plug does not fit into your outlet, consult an electrician for replacement of the obsolete outlet.

**Avertissement!** La sécurité de la prise polarisée ou de la prise de type mise à la terre ne doit en aucun cas être empêchée de fonctionner. Une prise polarisée a deux broches, l'une étant plus large que l'autre. Une prise de type mise à la terre a deux broches et une troisième broche pour la mise à la terre. La broche large ou la troisième broche sont fournies pour votre sécurité. Si la prise fournie ne s'insère pas dans votre prise femelle, consultez un électricien pour le remplacement de la prise femelle obsolète.

**Warnung!** Der Sicherheitszweck des gepolten bzw. Schukosteckers ist zu berücksichtigen. Ein gepolter Stecker verfügt über zwei Pole, von denen einer breiter als der andere ist. Ein Schukostecker verfügt neben den zwei Polen noch über einen dritten Pol zur Erdung. Der breite Pol bzw. der Erdungspol dienen der Sicherheit. Wenn der zur Verfügung gestellte Stecker nicht in Ihren Anschluss passt, konsultieren Sie einen Elektriker, um den veralteten Anschluss zu ersetzen.

**¡Advertencia!** No eche por tierra la finalidad del tipo de enchufe polarizado con conexión a tierra. Un enchufe polarizado tiene dos espigas, una más ancha que la otra. Un enchufe con conexión a tierra tiene dos espigas iguales y una tercera espiga que sirve para la conexión a tierra. La espiga ancha, o la tercera espiga, sirven para su seguridad. Si el enchufe suministrado no encaja en el tomacorriente, consulte con un electricista para reemplazar el tomacorriente obsoleto.

**Aviso!** Não anule a finalidade da segurança da ficha polarizada ou do tipo ligação terra. Uma ficha polarizada tem duas lâminas sendo uma mais larga do que a outra. Uma ficha do tipo de ligação à terra tem duas lâminas e um terceiro terminal de ligação à terra. A lâmina larga ou o terceiro terminal são fornecidos para sua segurança. Se a ficha fornecida não couber na sua tomada, consulte um electricista para a substituição da tomada obsoleta.

**Avviso!** Non compromettere la sicurezza della spina polarizzata o con messa a terra. Una spina polarizzata ha due spinotti, di cui uno più largo. Una spina con messa a terra ha due spinotti e un terzo polo per la messa a terra. Lo spinotto largo o il terzo polo sono forniti per motivi di sicurezza. Se la spina fornita non si inserisce nella presa di corrente, contattare un elettricista per la sostituzione della presa obsoleta.



**Warning!** Since the Mains plug is used as the disconnection for the device, it must remain readily accessible and operable.

**Avertissement!** Puisque la prise principale est utilisée pour débrancher l'appareil, elle doit rester aisément accessible et fonctionnelle.

**Warnung!** Da der Netzstecker als Trennvorrichtung dient, muss er stets zugänglich und funktionsfähig sein.

**¡Advertencia!** Puesto que el enchufe de la red eléctrica se utiliza como dispositivo de desconexión, debe seguir siendo fácilmente accesible y operable.

**Aviso!** Dado que a ficha principal é utilizada como a desconexão para o dispositivo, esta deve manter-se prontamente acessível e funcional.

**Avviso!** Poiché il cavo di alimentazione viene usato come dispositivo di sconnessione, deve rimanere prontamente accessibile e operabile.



**Warning!** Protect the power cord from being walked on or pinched particularly at plugs, convenience receptacles, and the point where they exit from the device.

**Avertissement!** Protégez le cordon d'alimentation pour que l'on ne marche pas dessus ou qu'on le pince, en particulier au niveau des prises mâles, des réceptacles de convenance, et à l'endroit où il sort de l'appareil.

**Warnung!** Vermeiden Sie, dass auf das Netzkabel getreten oder das Kabel geknickt wird, insbesondere an den Steckern, den Steckdosen und am Kabelausgang am Gerät.

**¡Advertencia!** Proteja el cable de energía para que no se le pise ni apriete, en especial cerca del enchufe, los receptáculos de conveniencia y el punto del que salen del equipo.

**Aviso!** Proteja o cabo de alimentação de ser pisado ou de ser comprimido particularmente nas fichas, em tomadas de parede de conveniência e no ponto de onde sai do dispositivo.

**Avviso!** Proteggere il cavo di alimentazione in modo che nessuno ci cammini sopra e che non venga schiacciato soprattutto in corrispondenza delle spine e del punto in cui esce dal dispositivo.



**Warning!** Unplug this device during lightning storms or when unused for long periods of time.

**Avertissement!** Débranchez cet appareil pendant les orages avec éclairs ou s'il est inutilisé pendant de longues périodes.

**Warnung!** Das Gerät ist bei Gewitterstürmen oder wenn es über lange Zeiträume ungenutzt bleibt vom Netz zu trennen.

**¡Advertencia!** Desenchufe este dispositivo durante tormentas eléctricas o cuando no se lo utilice por largos periodos del tiempo.

**Aviso!** Desconecte este dispositivo da tomada durante trovoadas ou quando não é utilizado durante longos períodos de tempo.

**Avviso!** Utilizzare soltanto i collegamenti e gli accessori specificati e/o venduti dal produttore, quali il treppiedi e l'esoscheletro.



**Warning!** Ensure Mains Power is disconnected before installing the OG-DANTE-12GAM modules into the frame, or installing and removing options. If a Mains switch is not provided, the power cord(s) of this equipment provide the means of disconnection. The socket outlet must be installed near the equipment and must be easily accessible.

**Avertissement !** Avant d'installer des modules OG-DANTE-12GAM dans la structure, ainsi qu'avant d'installer ou d'enlever des options, assurez-vous d'avoir déconnecté l'alimentation électrique. S'il n'y a pas d'interrupteur électrique, il faut débrancher les câbles électriques de l'équipement. La prise électrique doit être située à proximité de l'équipement et doit être aisément accessible.

**Achtung!** Sicherstellen, dass die Netzleitung entkoppelt ist, bevor die OG-DANTE-12GAM Module in das Gestell eingebaut oder Wahlteile eingebaut bzw. ausgebaut werden. Wenn kein Netzschalter vorgesehen ist, dient das bzw. dienen die Netzkabel dieser Vorrichtung als Entkopplungsmittel. Die Steckdose muss in der Nähe der Vorrichtung installiert und leicht zugänglich sein.

**Avvertenza.** Accertarsi che l'alimentazione di rete sia scollegata prima di installare i moduli OG-DANTE-12GAM nel frame o di installare e rimuovere componenti opzionali. Se non è presente un interruttore di accensione/spengimento, occorre scollegare il cavo (o i cavi) di alimentazione di questo apparecchio dalla presa di corrente. La presa di corrente deve essere situata presso l'apparecchio e facilmente accessibile.

**Aviso!** Certifique-se que a fonte principal de energia elétrica está desconectada antes de instalar os módulos OG-DANTE-12GAM no bastidor ou antes de instalar e remover opções. Se o interruptor principal não existir, o cabo elétrico deste equipamento proporciona o meio de desconexão. A tomada elétrica deverá ser instalada perto do equipamento e deverá ser de fácil acesso.

**¡Advertencia!** Asegúrese que la red de alimentación está desconectada antes de instalar los módulos OG-DANTE-12GAM en el marco, o la instalación y extracción de opciones. Si no se proporciona un conmutador de red, el cable de alimentación de este equipo proporciona los medios de desconexión. El zócalo tomacorriente debe estar instalado cerca del equipo y debe ser fácilmente accesible.



**Warning!** Dual Power Cord Notice—please read this. To reduce the risk of electrical shock, disconnect both power cords before servicing equipment.

**Avertissement !** Avis concernant la double alimentation électrique—à lire soigneusement. Pour éviter tout risque d'électrocution, débranchez les deux câbles électriques avant d'intervenir sur l'équipement.

**Achtung!** Hinweis auf Doppel-Netzkabel-bitte lesen. Um das Risiko eines Elektroschocks zu verringern, müssen beide Netzkabel ausgestöpselt werden, bevor die Vorrichtung gewartet wird.

**Avvertenza.** Avviso concernente il cavo di alimentazione doppio - leggere attentamente. Per ridurre il rischio di elettrocuzione, scollegare entrambi i cavi di alimentazione prima di eseguire la manutenzione o riparazioni di questo apparecchio.

**Aviso!** Aviso de Cabo Elétrico Duplo - por favor, leia isto. Para reduzir o risco de choque elétrico, desconecte ambos os cabos elétricos antes de fazer manutenção ao equipamento.

**¡Advertencia!** Aviso del doble cable de alimentación - leer esto por favor. Para reducir el riesgo de descarga eléctrica, desconecte ambos cables de alimentación antes de dar servicio al equipo.



**Caution!** The OG-X-FR front fan door is heavy. Remove with Caution.

**Attention!** La porte du ventilateur avant OG-X-FR est lourde. Retirer avec précaution.

**Achtung!** Die OG-X-FR -Frontlüfter Tür ist schwer. Bitte vorsichtig entfernen.

**¡Precaución!** La puerta del ventilador frontal OG-X-FR es pesado. Extraer con precaución.

**Atenção!** A porta do ventilador frontal OG-X-FR é pesado. Remova com cuidado.

**Attenzione!** La porta ventola anteriore OG-X-FR è pesante. Rimuovere con cautela.



**Warning!** Do not open the chassis. There are no user-serviceable parts inside. Opening the chassis will void the warranty unless performed by an AJA service center or licensed facility.

**Avvertissement!** Ne pas ouvrir le châssis. Aucun élément à l'intérieur du châssis ne peut être réparé par l'utilisateur. La garantie sera annulée si le châssis est ouvert par toute autre personne qu'un technicien d'un centre de service ou d'un établissement agréé AJA.

**Warnung!** Öffnen Sie das Gehäuse nicht. Keine der Geräteteile können vom Benutzer gewartet werden. Durch das Öffnen des Gehäuses wird die Garantie hinfällig, es sei denn, solche Wartungsarbeiten werden in einem AJA-Service-Center oder einem lizenzierten Betrieb vorgenommen.

**¡Advertencia!** No abra el chasis. El interior no contiene piezas reparables por el usuario. El abrir el chasis anulará la garantía a menos que se lo haga en un centro de servicio AJA o en un local autorizado.

**Advertência!** Não abra o chassi. Não há internamente nenhuma peça que permita manutenção pelo usuário. Abrir o chassi anula a garantia, a menos que a abertura seja realizada por uma central de serviços da AJA ou por um local autorizado.

**Avvertenza!** Non aprire lo chassis. All'interno non ci sono parti riparabili dall'utente. L'apertura dello chassis invaliderà la garanzia se non viene effettuata da un centro ufficiale o autorizzato AJA.



**Caution!** To meet safety regulations for leakage current, connect the dual power supplies to separate branch circuits.

**¡Advertencia!** Para cumplir con las normas de seguridad para la corriente de fuga, conecte las dos fuentes de alimentación para circuitos derivados diferentes.

**Attention!** Pour répondre aux mesures de sécurité concernant le courant de fuite, raccorder les sources d'alimentation doubles à des circuits de dérivation distincts.

**Warnung!** Zur Erfüllung der Sicherheitsbestimmungen bezüglich Reststrom schließen Sie bitte die zwei Netzteile an unterschiedlichen Abzweigleitungen an.

**Cuidado!** Para atender aos regulamentos de segurança para correntes de fuga, conecte as fontes duplas a circuitos elétricos separados.

**Attenzione!** Per soddisfare le norme di sicurezza sulla corrente di perdita, collegare i doppi alimentatori a circuiti derivati separati.

# Warranty and Liability Information

---

## Limited Warranty on Hardware

---

AJA Video Systems, Inc. (AJA Video) warrants that the hardware product, not including software components, will be free from defects in materials and workmanship for a period of five years from the date of purchase. AJA Video provides a separate software warranty as part of the license agreement applicable to software components.

If the Customer brings a valid claim under this limited warranty for a hardware product (hereafter, a “product”) during the applicable warranty period, AJA Video will, at its sole option and as the Customer’s sole remedy for breach of the above warranty, provide one of the following remedies:

- Repair or facilitate the repair the product within a reasonable period of time, free of charge for parts and labor.
- Replace the product with a direct replacement or with a product that performs substantially the same function as the original product.
- Issue a refund of the original purchase price less depreciation to be determined based on the age of the product at the time remedy is sought under this limited warranty.

To obtain service under this warranty, the Customer must notify AJA Video of the defect before expiration of the warranty period and make suitable arrangements for the performance of service by contacting AJA Video support through the channels set forth on the support contacts web page at <https://www.aja.com/support>. Except as stated, the Customer shall bear all shipping, packing, insurance and other costs, excluding parts and labor, to effectuate repair. Customer shall pack and ship the defective product to a service center designated by AJA Video, with shipping charges prepaid. AJA Video shall pay to return the product to Customer, but only if to a location within the country in which the AJA Video service center is located. SOME JURISDICTIONS DO NOT ALLOW THE EXCLUSION OF IMPLIED WARRANTIES OR LIMITATIONS ON APPLICABLE STATUTORY RIGHTS OF A CONSUMER, SO SOME OR ALL OF THE TERMS OF THIS PARAGRAPH MAY NOT APPLY TO YOU.

## Limitation of Liability

---

Under no circumstances shall AJA video BE LIABLE IN ANY WAY FOR ANY LOST, CORRUPTED OR DESTROYED DATA, FOOTAGE OR WORK, OR FOR ANY OTHER INDIRECT, SPECIAL, INCIDENTAL OR CONSEQUENTIAL DAMAGES OR LOST PROFITS, OR FOR ANY THIRD PARTY CLAIM, IN CONNECTION WITH THE PRODUCT, WHETHER RESULTING FROM DEFECTS IN THE PRODUCT, SOFTWARE OR HARDWARE FAILURE, OR ANY OTHER CAUSE WHATSOEVER, EVEN IF AJA VIDEO HAS BEEN ADVISED OF THE POSSIBILITY OF SUCH DAMAGES. AJA VIDEO’S LIABILITY IN CONNECTION WITH THE PRODUCT SHALL UNDER NO CIRCUMSTANCES EXCEED THE PURCHASE PRICE PAID FOR THE PRODUCT. The foregoing limitations apply even if any remedy set forth in this LIMITED WARRANTY fails of its essential purpose. SOME JURISDICTIONS DO NOT ALLOW THE LIMITATION OF LIABILITY FOR PERSONAL INJURY, OR OF INCIDENTAL OR CONSEQUENTIAL DAMAGES, SO SOME OR ALL OF THE TERMS OF THIS PARAGRAPH MAY NOT APPLY TO YOU.

## Governing Law and Language; Your Rights

---

This limited warranty is the only warranty provided by AJA Video on the hardware product. It supersedes all prior or contemporaneous understandings regarding such subject matter. No amendment to or modification of this warranty will be binding unless in writing and signed by AJA Video. The laws of the State of California, USA will govern this warranty and any dispute arising from it. Any translation of this



Agreement is intended for convenience and to meet local requirements and in the event of a dispute between the English and any non-English versions, the English version of this warranty will govern. This limited warranty gives you specific legal rights and you may have other rights that vary from jurisdiction to jurisdiction, some of which are noted above.

# Index

---

## A

AJA Support 2

## C

Configuration Settings  
Stored in OG cards 14

## D

Dante Controller  
Downloading 24  
Training Videos 24  
DashBoard Control System 9  
Card Tab Screen 16  
Control Interface Basic  
Components 14  
Documentation 14  
Downloading 14  
Rebooting 23  
Requirements 14  
Uploading New Software 21  
Using 14  
Diagram  
Simplified Block 6

## F

Features 5

## I

Installation 9  
Cabling 13  
Front Card Installation 12  
Rear Card Installation 10

## O

openGear and AJA 9  
Overview 4

## S

Setup Tab Screen 21  
Signal Indicators  
DashBoard Control System 7  
Status Tab Screen 17

## T

Technical Support 2

## U

User Controls 9