



NINJA V

User Manual

EDITION 1: NOVEMBER 2018



Register your NINJA V within twelve months of purchase to upgrade to a 3 year warranty*

Registering your product ensures you receive communication on all future updates

Contents

Warranty & Conditions

Introduction

1. What's included

2. What you also need

Media (HDD/SSD)

HDMI Cables

Standard 1/4" or 3/8" mount

3. Mounting disks in the Master Caddy II

4. Connecting and powering up

Power ON/Power OFF

5. Ninja V connections

6. AtomX SSDmini, Master Caddy II and Screw Mounts

Master Caddy II / SSDmini / Mounting options

7. Using the Ninja V

AtomOS10

Best Practice

- Format Media

- Unit Name

- File naming

- Screen Lock

- Firmware updates

Main Screen - Home

Main Screen - Information Bar

Home Screen / Menu functions

Home Screen and Menu Functions

Information Bar

Output / Record

File / Meters

Audio / Media / Timecode

Date and Time

Battery / Info

8. Monitoring & Recording

Setting up for recording

SmartControl

Monitor Features

Using Waveform Monitoring Tools

Luma Overlay / RGB Parade / Vectorscope

Using Monitor Assist

Focus Assist / Zebra / False Color

Blue Only / Zoom / Grid Lines / Focus Assist Settings

LUTs

Monitor

- Using Standards – Native / Rec709 / HLG / PQ

- Understanding HDR and Log

Display

File Recovery

9. Playback & Playout

Playback Mode

Playlists

Video Format

10. Edit

SmartLog / Export XML

11. HD Pulldown

12. Connecting and Editing

Connect to Input

NLE Support

exFAT compatibility

Transferring files

Importing / Import into Final Cut Pro X

13. Technical Specifications

14. Optional Accessories

Safety Instructions

1 The Ninja V is designed to a high standard but there are some things you
2 should be aware of to prolong the life of the unit and for your own safety.

3

4

Using the Ninja V safely

4 Although the Ninja V is very lightweight compared to all the devices it
5 replaces, it is still a solid object that could cause injury if misused.

5

6 • Always make sure that the Ninja V is mounted securely and is unable
7 to fall onto anyone nearby. This is especially important when there are
7 children present who might be tempted to pull on cables.

9 • Always ensure that cables that run to the Ninja V are clearly visible and
10 do not present a trip hazard.

11 • Do not place on uneven or unstable surfaces.

11 • Do not insert anything but a Ninja V Master Caddy II or AtomX SSDmini
11 in the drive slot on the rear of the Ninja V.

11 • Do not touch the Ninja V screen with sharp, metallic or abrasive objects.

13 • Do not expose to strong electrical or magnetic fields.

13 • Do not expose to liquids, rain or moisture.

13 • Do not dispose of the Ninja V in municipal waste and do not incinerate it,
13 always follow local regulations for safe disposal.

14

15

Care of disk drives

16 Spinning disks and SSDs are very sensitive to damage from static electricity.

17 Please observe all the usual electrostatic discharge (ESD) precautions
18 when handling them.

19

20 Please see the section on mechanical shock and vibration later in this
21 manual for information about how to handle and care for your disk drives.

22

23

HDMI cables

24 Please remember that almost all HDMI cables do not use locking
25 connectors and will simply pull out if they are jerked or tripped over. Please
25 ensure your cables make a secure connection and avoid flexing them
26 excessively to maintain reliability.

26

27

27

28

28

29

30

31

31

32

33

33

34

35

35

36

37

38

40

41

41

41

41

41

42

44

45

User Manual Conventions

To keep things simple but clear, we've only adopted two conventions in this manual:



A helpful tip, suggestion or something to note because it's not obvious at first.



An important note or warning

Warranty & Conditions

International Hardware Limited Warranty

ATOMOS warrants that:

- The main product, not including the IPS screen, or any external accessories, will be free from defects in materials and workmanship for a period of 1 year from the date of purchase; or 3 years upon completion of product registration within 1 year from the date of purchase at www.atomos.com
- The TFT/LCD, HDD/SSD Docking Station, Master Caddy II and Cable will be free from defects in materials and workmanship for a period of 1 year from the date of purchase.

This warranty is exclusively for the benefit of the original purchaser and is not assignable or transferable.

If during the warranty period the product is shown to be defective ATOMOS may at its option:

- a) replace the goods or supply equivalent ones,
- b) repair the goods,
- c) pay the cost of replacing the goods or of acquiring equivalent ones and
- d) paying the cost of having the goods repaired;

The customer must notify ATOMOS of any defect in the goods in writing prior to the expiry of the warranty periods set out above. The customer will be solely responsible for returning the goods to ATOMOS or its authorized distributor. Upon acceptance of a warranty claim by ATOMOS, where ATOMOS repairs or replaces the goods, it will be responsible for reasonable shipping costs incurred in sending the goods to the Customer, provided that customer is located in a country in which ATOMOS has an authorized distributor or repair center or agent.

Warranty Exclusions

This warranty applies only to defects in workmanship and does not cover defects caused by:

- Neglect;
- Improper or negligent acts or omissions;
- Repairs or attempted repairs;
- Tampering with or modification of the goods;
- Connection to incompatible equipment or power sources;
- Exposure to water or weather;
- Exposure to magnetic fields or corrosive liquids or substances;
- Physical damage

Except as stated in this warranty, Atomos, its vendors, agents, resellers and distributors disclaim in their entirety all other warranties, express or implied, including without limitation all warranties of merchantability or fitness for a particular purpose. The remedies outlined in this warranty are the exclusive remedy a customer from defective goods, which are subject to the warranty.

Atomos does not warrant that the goods will operate in a manner that is error free, or uninterrupted. The goods are not intended to be the primary or only data storage device for data – customers are solely responsible for back up and protection of data.

Software License Agreement

IMPORTANT, PLEASE READ CAREFULLY. THIS IS A LICENSE AGREEMENT.

This ATOMOS software, related documentation, any included sample images files (the "Software"), is protected by copyright laws and international copyright treaties, as well as other intellectual property laws and treaties. The Software is licensed, not sold.

This End User License Agreement ("EULA") is a legal agreement between you (either an individual or a single entity) and ATOMOS with regard to the copyrighted Software provided with this EULA. Use of the Software provided to you by ATOMOS in whatever form or media, will constitute your

acceptance of these terms, unless separate terms are provided by the software supplier, in which case certain additional or different terms may apply. If you do not agree with the terms of this EULA, do not download, install copy or use the Software. By installing, copying or otherwise using the Software, you agree to be bound to the terms of this EULA. If you do not agree to the terms of this EULA, ATOMOS is unwilling to license the Software to you.

- 1. Eligible licensees.** This Software is available for license solely to purchasers of the ATOMOS Ninja V, who have purchased a unit manufactured by ATOMOS Ninja V and purchased through an ATOMOS authorized reseller, with no right of duplication or further distribution, licensing or sub-licensing.
- 2. License Grant.** ATOMOS grants you a personal, non-transferable and non-exclusive right to use the copy of the Software provided with this EULA. You agree you will not copy the Software except as necessary to use it with the ATOMOS Ninja V. You agree that you may not copy the written materials accompanying the Software. Modifying, reverse engineering, translating, renting, copying, transferring or assigning all or part of the Software or any rights granted hereunder, to any other persons or reverse engineering the hardware on which the Software runs, is strictly prohibited. The software is license, not sold. You acknowledge that no title to intellectual property in the Software is transferable to you. You further acknowledge that title and full ownership rights to the Software will remain the exclusive property of ATOMOS and/or its suppliers, and you will not acquire any rights to the Software, except as expressly set forth above. All copies of the software will contain the same proprietary notices as contained in or on the Software. All title and copyrights in and to the Software (including but not limited to any images, animations, video, audio, text incorporated), the accompanying printed materials, and any copies of the Software are owned by ATOMOS or its suppliers.
- 3. Reverse engineering.** You agree that you will not attempt, and if you are a corporation, you will use your best efforts to prevent your employees and contractors from attempting to reverse compile, derive circuits, modify, translate or disassemble the Software and/or the Atomos Ninja V in whole or in part. Any failure to comply with the above or any other terms and conditions contained herein will result in the automatic termination of this license and the reversion of the rights granted hereunder by ATOMOS.

ATOMOS reserves the right to terminate this license without prejudice to any additional recourse ATOMOS may have against you if you violate any of its terms and conditions.

Notice

Copyright © 2018 ATOMOS Global Pty Ltd ('referred to as ATOMOS'). All rights reserved. All information in this document is subject to change without notice. No part of the document may be reproduced or transmitted in any form, or by any means, electronic or mechanical, including photocopying or recording, without the express written permission of ATOMOS. A reference to ATOMOS includes its related entities, subsidiaries and parent company.

Trademarks

Ninja V and ATOMOS are registered trademarks of ATOMOS. Apple, the Apple logo, AppleShare, AppleTalk, FireWire, iPod, iPod Touch, Mac, and Macintosh are registered trademarks of Apple Inc. Final Cut Pro, QuickTime and the QuickTime Logo are trademarks of Apple Inc. DNxHD, DNxHR and Avid logo are registered trademarks of Avid Technology, Inc. All other trademarks are the property of their respective holders.

REGISTRATION + WARRANTY UPGRADE

Register within 12 months of purchase date to upgrade your standard 1 year warranty to a 3 year warranty.

Visit: www.atomos.com/register

Registered users receive updates of all AtomOS updates upon release.

Introduction

NINJA V

Thank you for choosing the Atomos Ninja V 5 inch 4Kp60 HDR Monitor Recorder. Featuring a super high-resolution screen in a lightweight aluminium alloy chassis, and an array of essential production tools including waveform monitoring, vectorscope, focus assist and the world's leading support for HDR monitoring; Ninja V will give you the creative and commercial advantage you've been looking for.

This user manual will get you up to speed with all the amazing features packed into the Ninja V that will assist you during a shoot and speed up your workflow on set and in post production.

Stay up-to-date with the latest information and software by registering your product today

www.atomos.com/support



ProRes

4K
60 P

HD
50/60p

AtomHDR

5"
HIGH BRIGHT
1000 nit

HDMI

Avid DNxHR

1. What's included

NINJA V

Your Ninja V includes base accessories to get you started, such as a mains power supply and a media Master Caddy. Additionally you will need a 2.5" Solid State Drive (SSD) or AtomX SSDmini, a compatible HDMI cable (Camera out/Ninja in) and compatible batteries. Optional AtomX accessories including power and accessory kits and are also available. Visit the Atomos website for the latest accessory options.

Not all drives are compatible with the Ninja V.
For the most up-to-date information please visit:
www.atomos.com/drives

Included:

- **Ninja V**
- **1 x Master Caddy II + screws**
- **12V-3A AC power supply**
- **Battery Eliminator**
- **Ninja V Quick Start Guide**



2. What you also need

■ Media

We have worked closely with Angelbird and Sony to develop new media designed specifically for the Atomos Ninja V. The new AtomX SSDmini is smaller than a standard SSD, but utilises the same SATA connection as normal HDD/SSD media and is compatible with all Atomos recorders and docking stations. AtomX SSD mini fits directly into the Ninja V without the need for a Master Caddy II.



Widely available 2.5" SSDs are the basic storage media for Atomos 4K Monitor Recorders. We work closely with leading drive manufacturers to qualify as many options as possible. SSDs are required for 4K recording or for more demanding production environments that may not be suited to spinning hard disks.



Which drives should you use?

There are so many drives available, and newer models appear all the time. To avoid potential data loss and/or write/read errors, Atomos only recommends the use of approved SSD media only.

We are not able to test all drives but here are some guidelines.

Solid State Drives (SSDs) are recommended for all recording up to 4kUHDp30 and specific drives with sustained high performance write speeds for 4kDCIp60.

Spinning Disk Drives (HDD) are not recommended.

HDDs are not suitable for 4K recording or for use in environments or situations where they are subject to movement.

Speed and reliability are the main factors. Here are a few things to bear in mind:

- Disk drive data rates tend to be given in megabytes per second, and codec data rates are normally given in megabits per second. It's very easy to get confused. But there's no need to be, because all you have to do to convert megabits to megabytes is divide by 8. So if you're recording at 220 megabits per second, that's going to result in 220/8 megabytes per second, which is 27.5 megabytes per second.
- With 4K recording your data rate is approximately four times that of HD recording, so please ensure your drive is capable of keeping up with 4K write speed requirements.

Atomos regularly tests hard drives – please check this link before purchasing drives: www.atomos.com/drives

Mechanical shock and vibration for Spinning Disk HDDs

Hard disks are precision mechanical devices that need to be handled carefully. The use of mechanical drives or Solid State drives will vary depending on the intended filming application.

We can't give rigid guidelines because there are so many different kinds of drives, each which has different mechanical properties. You may even find variations between drives of the same type.

What we have found is that mechanical drives are suitable for most purposes that don't involve harsh vibration or mechanical shocks. We would not advise using mechanical disks if there is a likelihood that they might be shaken or dropped onto a hard surface.

Here are some things that you should bear in mind when using spinning disks:

- Even though spinning drives can withstand substantial shocks when they are not in use, they are more vulnerable when running. Harsh treatment that may not actually damage the drive may interrupt recordings at a much lower level of severity. We recommend that you experiment with your drives by testing them in the conditions that you normally work in.
- Do not bang or jolt the Ninja V while recording.
- Do not use spinning drives (HDD) for recording 4K video
- You will find noticeable differences in the ability of different drives to withstand shock and to continue recording during vibration and movement.

2. What you also need

Backing up and archiving

Remember that no storage media, including tape, optical disks, spinning disks and flash memory, is completely immune from failure.

You should bear this in mind when deciding how to manage your recorded content. At the very least, you should consider the consequences for you and your business if your storage media were to suffer from a sudden failure, and you should back up your content accordingly.

Deleting files

To ensure the integrity of data writes and to avoid situations such as fragmentation the AtomOS operating system on the Ninja V does not support the deletion of files. We also do not advise removing or deleting files randomly from the disk on your computer. Often files are left in the trash or garbage partition of the drive occupying drive cache and this can effect drive performance. It's advised that you archive your content and reformat the drive before each shoot. For more details on this see page 12.

HDMI cables

Take care to use HDMI cables of the appropriate grade and take care to protect them from damage. Signal issues can often result from damaged HDMI cables, or using cables that are too long.

Atomos make a range of professional HDMI cables which are ideal for connecting between your camera and Ninja V. For 4Kp50/60 recording we advise the use of Atomos HDMI 2.0 cables.

Not all HDMI cables are created equal and there are a variety of different qualities available. Please make sure you test your cables prior to shooting. This is particularly important when recording 4kp50/60. Many cables will claim to be high speed but will lack the required shielding on both cable and connector to maintain a high quality signal. If the signal contains errors that will affect your recording your Ninja V will may Lock to these inputs.



Also check your connectivity at both the camera connector and the recorder/monitor connector to make sure you have a firm connection to avoid any signal drop out.



If the HDMI cable is removed while recording the "Skippy" image will also be displayed. To remove touch Skippy and he will disappear ready for his next notification.

Refer to page 33, Atomos Anti-shock technology for more information about "Skippy".

Standard 1/4" or 3/8" Mount/Arm

The Ninja V is designed for versatility – including multiple mounting options to suit just about every possible scenario. The unit includes both 3/8-16 and 1/4-20 screw mounts top and bottom, along with ARRI's anti-rotational pin system for secure mounting to a wide range of arms, mounts and cages. It is compatible with the latest mounting solutions from companies such as Shape, SmallRig and Wooden Camera. Select the mount type that best suits your input device, application and conditions.



Ninja V (top view) shows 3/8-16 and 1/4-20 (adaptor) mounts and ARRI anti-rotational mount system. Below are some examples of tripod and hot shoe mounts, available from most camera and video specialists.



A secure mount will greatly enhance usability and security of HDMI, power, remote and audio connections. Related info on page 10.

3. Mounting disks in the Master Caddy II

Mounting drives in the Master Caddy II

If you choose to use your own disks instead of a pre-built AtomX SSDmini then follow this procedure to install it in the provided Master Caddy II.

Insert the disk into the caddy, and secure with four screws. These screws should be tightened so the screw heads are flush with the casing of the caddy. The caddy is light and the disk just needs to be held securely. Don't over-tighten the screws. There are no connections to make because sliding the Master Caddy II into the Ninja V or the docking station makes all the connections for you.

The Master Caddy can't be inserted the wrong way round. Always make sure that the disk connector faces the slot in the Ninja V. Push the Master Caddy II into place, but never force the disk just in case something isn't set up or aligned properly.

There is very little that can cause problems and the most likely thing is that the Master Caddy isn't properly flush with the drive inside. A quick visual check will confirm this.

- ⚠ *Spinning disks and SSDs are very sensitive to damage from static electricity. Please observe all the usual precautions when handling them, especially DO NOT EVER touch the exposed SATA connector as static electricity may be harmful to your disk.*
- ⚠ *Master Caddy II drives are backwards compatible with previous Atomos recorders, however Master Caddy 1 is not forward compatible with the Ninja V due to the compact latch design.*

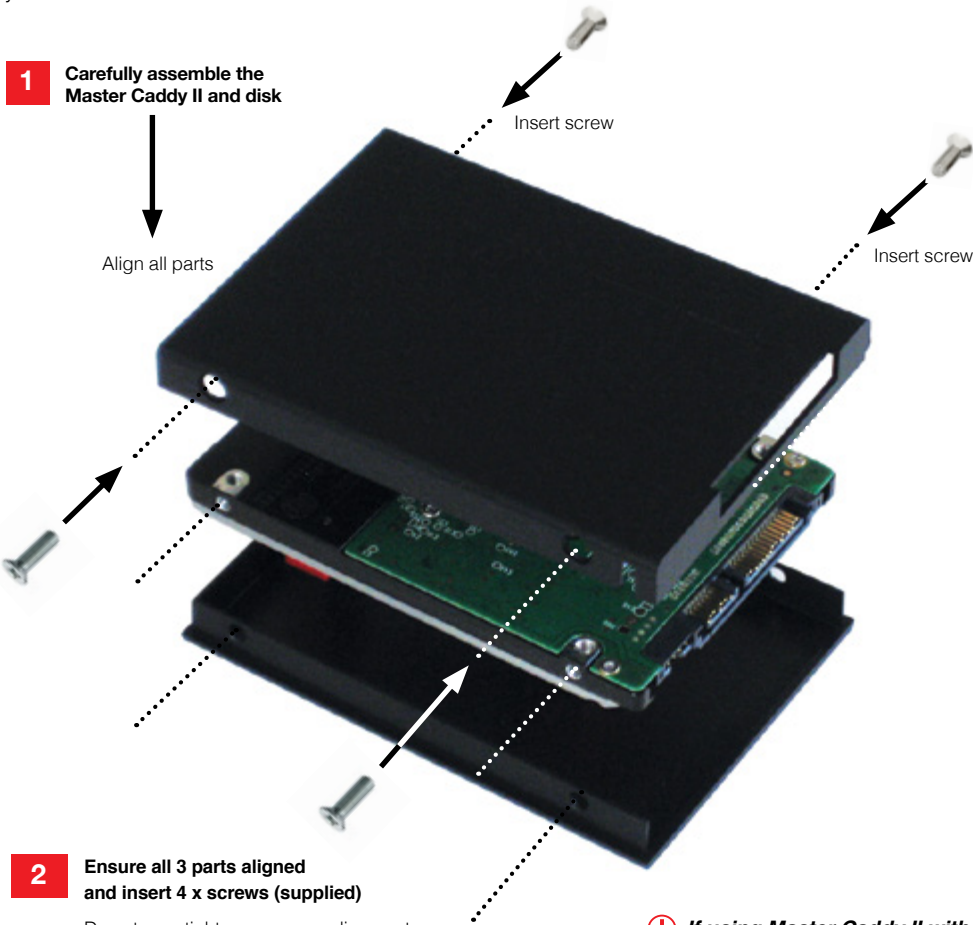

- ⚠ *If using Master Caddy II with Ninja V ensure all screws are tight and not protruding from casing. Loose screws may cause the caddy to become lodged in the disk slot.*

ATOM X

Introducing AtomX SSDmini

Atomos has teamed with the world's leading media manufacturers to design SSD media that is better suited to our ever evolving Monitor Recorders. The new AtomX SSDmini is a little over 1/4 inch tall and 3" long. It is also 20% shorter than traditional SSDs, yet keeps the standard SATA III connector. It is backward compatible with previous Atomos devices by adding a clever extension handle (SSDmini Adaptor). These tiny, slimline SSDs are a true innovation by our close drive partners Angelbird and Sony. 1TB AtomX SSDmini by Angelbird pictured (right).



4. Powering the Ninja V



Choosing your power source

The Ninja V can be powered by the included AC-powered Battery Eliminator, or by using a compatible DC battery. If you are the owner of other Atomos devices, the batteries you have for these devices (NP-F series) will be compatible with your new Ninja V.

Battery Eliminator

Included in the Ninja V box is a Battery Eliminator. This connects directly to the battery slot of your Ninja V and enables AC power connection. Please note the Battery Eliminator is suitable for use with Atomos devices only and is compatible with the Atomos coiled DC to D-Tap cable.

Batteries

We recommend the use of optional Atomos NP-F type batteries and the Atomos Power Kit with the Ninja V. The Ninja V can also use standard NP-F compatible batteries. Charge new batteries before using them, using a compatible battery charger. To attach the battery, gently slide it down into the slot until it locks into position. To remove a battery, push the latch to release it.

⚠ Before any type of disposal the battery should be discharged completely. Tape the contacts with electrical tape and package so as to prevent contacts accidentally coming together at any time.

⚠ Incineration must be performed by an approved and permitted waste treatment facility that handles lithium ion batteries. If you are not sure if your waste facility can handle lithium ion batteries, contact them and verify if they are permitted or not.

Atomos NP-F Battery Charger (optional)

The Atomos NP-F Battery Charger has been designed to rapidly charge the batteries yet be lightweight so that is easy to travel with.

In the unlikely event of a charge error the first and fast red LEDs flashing quickly.

⚠ Fast charging of the battery is possible up to 80% capacity and the remaining 20% will then charge at a slower rate to maintain good battery life.

⚠ Batteries do not charge in a linear way. At first they charge very quickly, and then the rate slows down to a trickle. While charging, one or more red lights will blink. When 90% charge is reached, all the lights will flash. It is perfectly OK to use the batteries at this point and we recommend stopping at this stage for the longest battery life. If you leave the batteries on charge after all four lights are flashing, the charger goes into trickle charging mode for the final 10%. Eventually, when trickle charging is complete, and the batteries are at 100% charge, all the lights will go out.

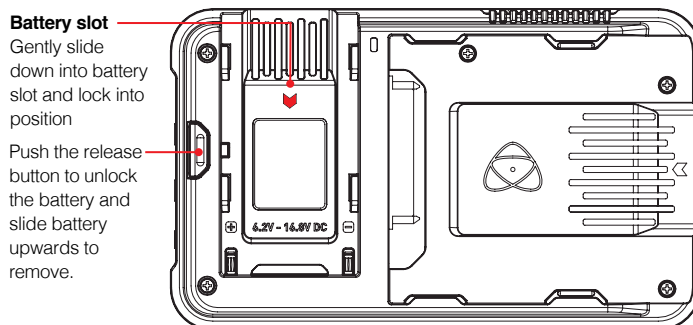

Choosing the right battery for your application

Size	Cells	Battery Life*
5200mAh	4	Up to 2.0hrs
7800mAh	6	Up to 3.0hrs
Battery Eliminator	-	Continuous AC
D-Tap	-	Source dependent

* Battery life tested during Monitor/Record 4Kp60 operation.

ⓘ We recommend using Atomos NP-F series batteries.

DC to D-Tap Coiled Cable

An optional Atomos accessory is a DC to D-Tap Coiled Cable. This is designed to allow you to power your device from an external battery system. To use this simply connect the D-Tap connector to your power source. Ensure that the output of the power source does not exceed 16.8V DC.

⚠ Ninja V batteries and modular accessories are held in place tightly because they are on the outside of the device, this is to ensure there is no possibility whatsoever that they work loose, so you may have to be quite firm with the battery latches. We suggest that you familiarize yourself with the force required to remove the batteries and accessories so that you can do this quickly in the field.

4. Powering the Ninja V

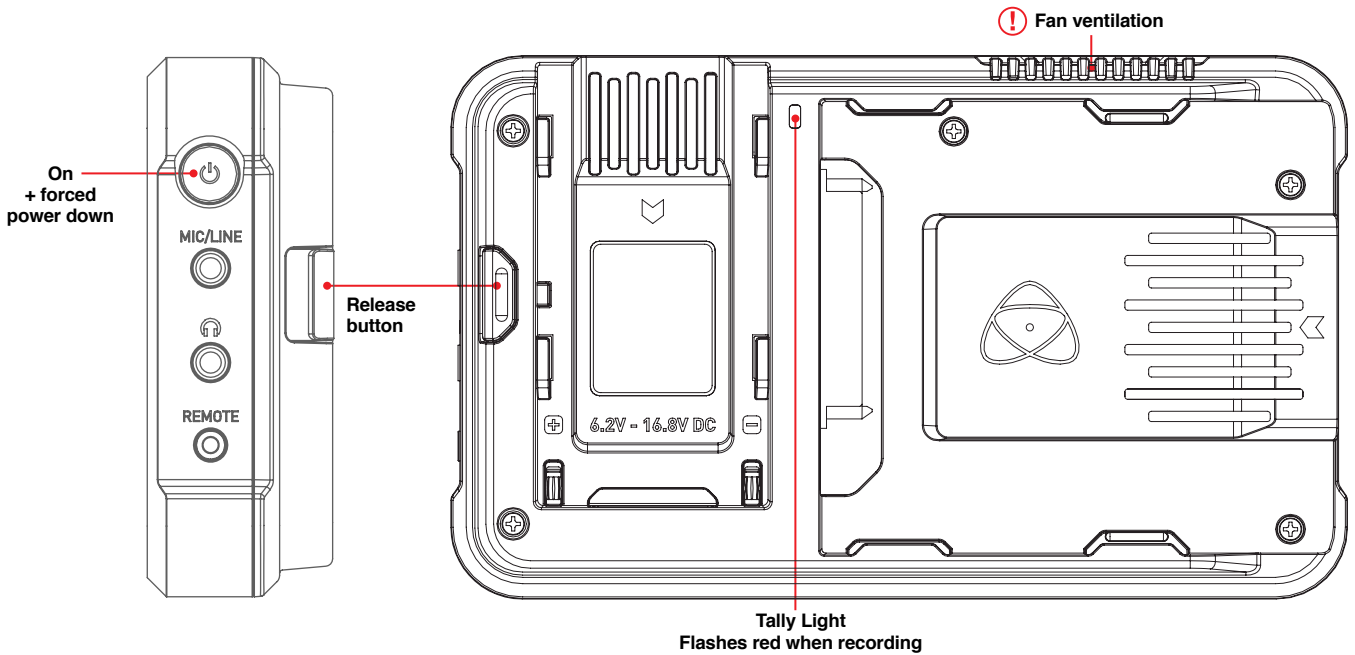

Turning ON power to the Ninja V

The start button is located on the top right hand side of the unit (as you look at the screen). With a charged battery attached momentarily press the recessed circular button on the top right side of the Ninja V as you look at the screen to power up the unit. After a couple of seconds you will see the Atomos logo, and then the Ninja V Home Screen.

Turning OFF power to the Ninja V

To turn the unit off, touch the **battery** icon on the top right of the home screen, and then **press the green Power icon for 4 seconds**. The icon will go red when touched to indicate activation of the button. The unit will then power off. You can also do a forced power down by **pressing the on/off button for four seconds**.

Four seconds can seem like a long time! We've made it this way to make absolutely certain that the Ninja V can't be turned off accidentally.

Do not press and hold the power button in on the Ninja V while the unit is off. This will place the device in a Firmware recovery mode. If you accidentally do this, simply turn the device off again or remove the power source.

Take note to respect the air flow and do not to obstruct the cooling vents of the unit.

Battery - Menu Screen

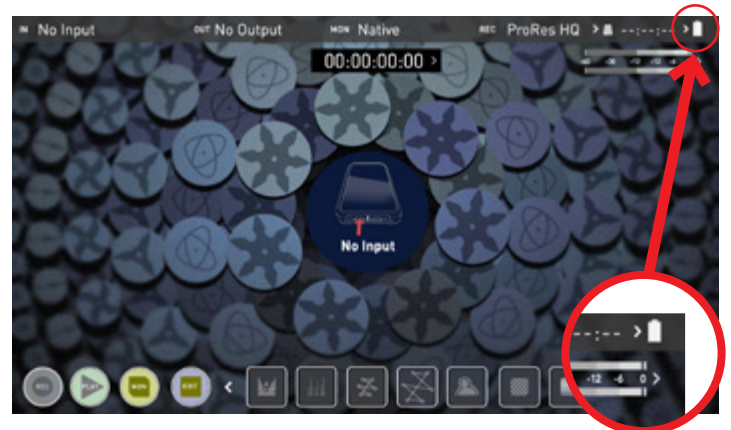

Power down

5. Ninja V Connections

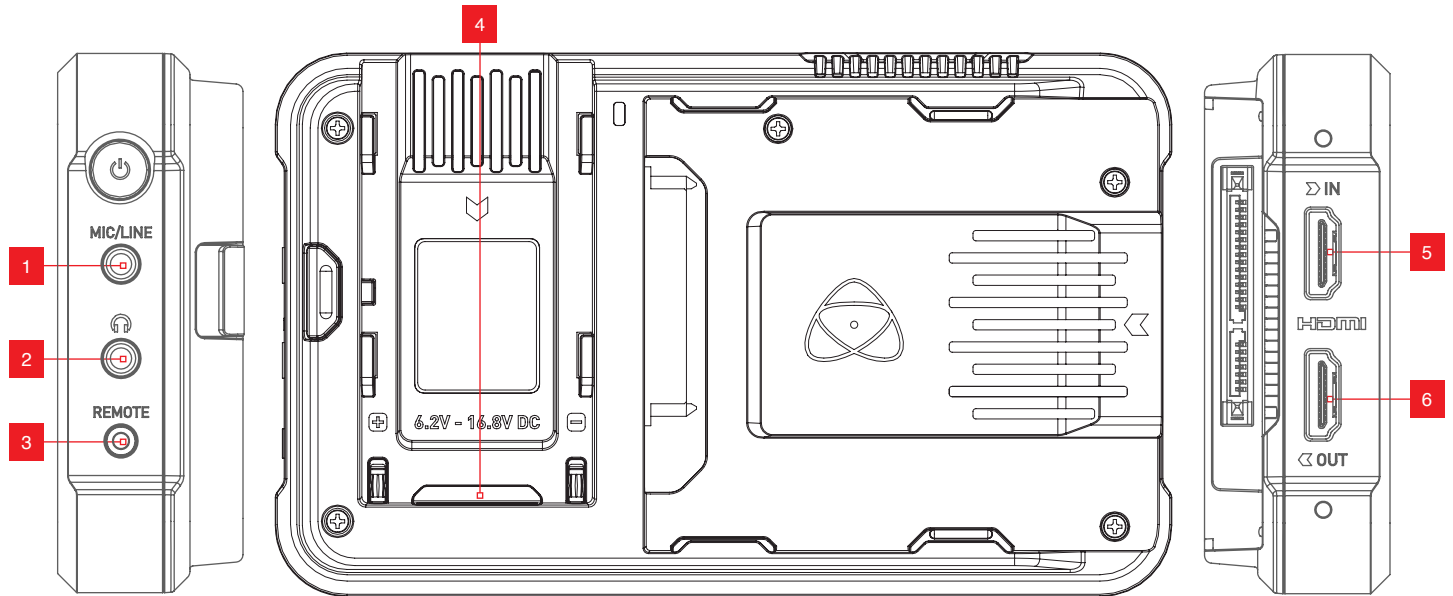

1. Mic/Line in

A 3.5mm input jack is located under the power button. Channel selection and volume for headphone monitoring is via the audio controls section, accessible by touching the audio meters in the upper right side of the touchscreen (monitoring mode) or in the bottom right of the screen (homescreen mode).

2. Headphone/audio out

A 3.5mm headphone jack is located above the remote port. Channel selection and volume for headphone monitoring is via the on-screen audio controls section, accessible by touching the audio meters in the upper right side of the touchscreen (monitoring mode) or in the bottom right of the screen (homescreen mode).

 *When monitoring any channels please ensure that the headphone selection is set to the stereo pair you'd like to monitor. For more details see page 21.*

3. Remote/Calibration Port

The calibration 2.5mm jack on the right hand side (looking from the front), allows for the connection of the X-Rite i1Display Pro calibration device. The calibration unit utilises the optional USB to serial adaptor cable. For optimal calibration it is recommended that your Ninja V is powered up for 30 minutes prior to calibration. The latest version of the Atomos Calibration software is available at www.atomos.com/support

For remote operations via this port AtomOS supports both LANC in Sony and Canon format. The Ninja V uses LANC Slave and so a LANC controller must first be attached to a camera and the output taken out via a Y cable to the Ninja V.

4. Expansion Slot

Enhance your Ninja V through the in-built modular expansion slot. Bi-directional high speed video, audio and power are available. Expansion modules dock into the battery slot and can be stacked, passing power and offering advanced connections and functions. www.atomos.com/AtomX

5. HDMI in

The video input is a full size HDMI 2.0a connection used to receive the video. This connection also supports embedded audio and timecode if your camera or device sends these out over HDMI. The image is both displayed and recorded to the Atomos monitor/recorder storage media.

Embedded Audio: Most mirrorless cameras and camcorders send two channels of audio over HDMI but the Ninja V can record up to 8 channels of digital audio embedded in the HDMI signal if supported.

6. HDMI out

This is for connection to an external monitor or other device with an HDMI input. It carries a loop-through of the incoming HDMI signal in record and standby mode, and the playback signal when the Ninja V is in playback mode. This output is 2.0a and can carry either a 4K or HD signal (with the option to down convert the 4K input to HD).

Video Scale Convert: Video out also has the option for a downscale to be applied allowing your 4K input to be converted to a 1080 HD output for use with existing HD equipment.

3D LUT Output

3D LUTs can be applied to the outputs of the Ninja V and LUTs can also be selected to be applied to the outputs and routed out to other equipment via the HDMI connections.

HDR Output

The Ninja V can read the incoming HDR information frame from compatible cameras that indicates if a signal is HLG or PQ. You can set the Ninja V to automatically detect this and loop this out. You can also convert between a Log input to HDR display standards or between HLG <=> PQ. For more information see Page 20.

6. AtomX SSDmini, Master Caddy II and Screw Mounts

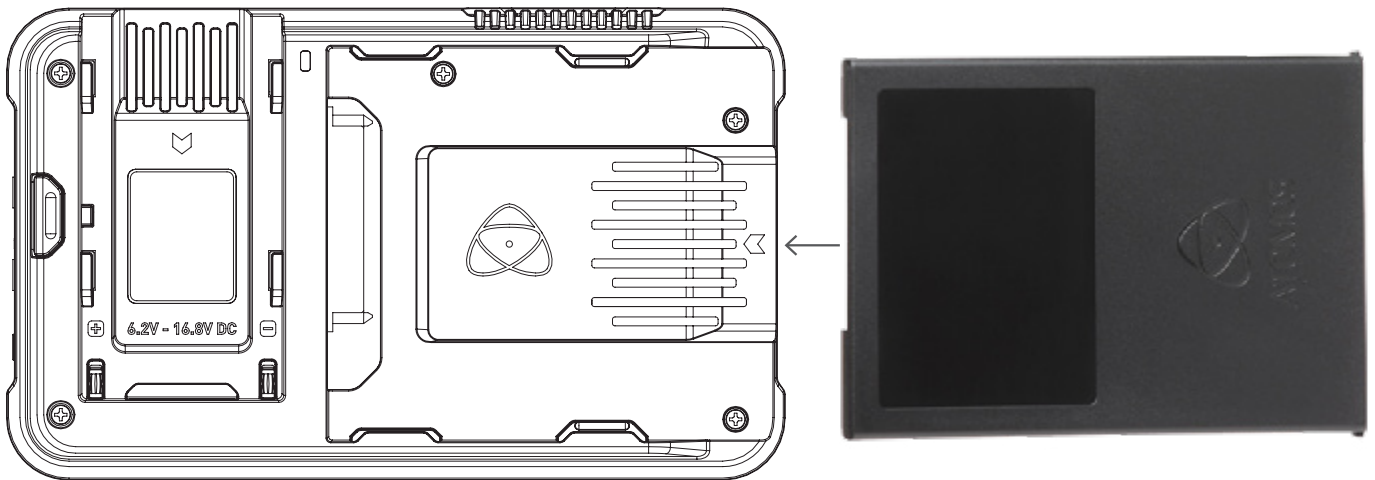

AtomX SSDmini / Master Caddy II Slot

On the rear of the unit is a 2.5" slot designed for Master Disk Caddy II or AtomX SSDmini. To insert your caddy or SSDmini, gently push until it stops as the end of the drive slot.



The SSDmini and Master Caddy II are both hot-swappable, so you can do this at almost any time – even while the unit is turned on. But don't do it while recording or you will get a corrupted file that may be unplayable.

⚠ The Ninja V disk slot does NOT have a release latch - it is friction-fit. Simply pull the SSDmini / Master Caddy II out using the top and bottom tabs on the caddy itself.

AtomX SSDmini is backwards compatible with previous Atomos recorders. The original Master Caddy 1 is not compatible with Ninja V as the keyways are on one side only.

AtomX SSDmini Handle available. Attach to SSDmini for use with existing Atomos Master Caddy II compatible devices, and reduce handling and potential damage to disk casing.

Flexible mounting options

The Ninja V is designed for versatility – including multiple mounting options. The unit includes both 3/8"-16 and 1/4"-20 screw mounts top and bottom, along with ARRI's anti-rotational pin system, ensuring it is secure on gimbals, and compatible with the latest mounting solutions.

The 1/4" adaptor is easily removed for mounting on 3/8" fixtures. To do so use a flathead screwdriver to gently loosen the adaptor and store your adaptors in a safe location.

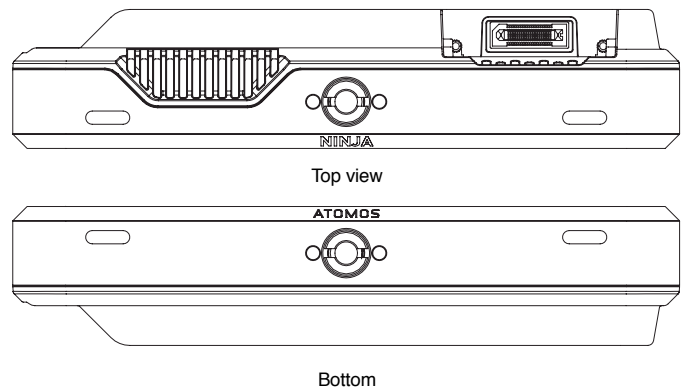

⚠ Ensure you do not over tighten the screw mounts as this may cause damage. Do not insert a 1/4"-20" or 3/8"-16 thread longer than 5mm or you will risk causing damage to the aluminium chassis.

7. Using the Ninja V

NINJA V

ATOM
OS10

With the introduction of AtomOS10 operating system for Ninja V, there have been some significant changes in the way we do things compared to our previous models – especially in the overall look and feel, the placement of buttons, and the way that AtomOS10 works.

With AtomOS10 you get the ultimate touch interface for monitoring and recording. This new version of our operating system has a clear, elegant design. It's easy to understand yet gives you total access to all functions. No complicated sequences of buttons. No endless menus crowded with text. It's optimized for our latest AtomIC hardware platform. And it's extremely responsive with fast boot up times.



7. Using the Ninja V - Best Practice

Understanding the basic controls and ‘housekeeping’ functions will save you time in the future. Before you start enjoying your Ninja V it will help to set it up with a ‘device name’ and file naming conventions.

- a. Format Media
- b. Unit Name
- c. File Naming
- d. Screen Lock
- e. Firmware Updates

a. Format Media (HDD/SSD)

Make sure your drive is correctly inserted and all data from previous shoots has been securely backed-up. Touching the **Storage Capacity Indicator** on the home screen will take you to the Media Menu.

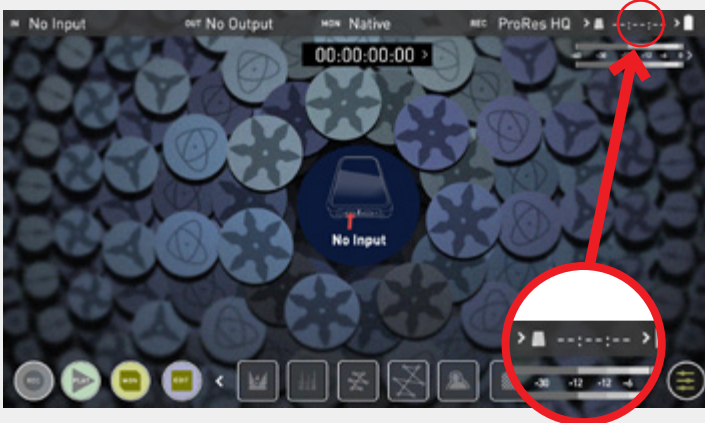

This menu provides information on the drive currently inserted. To format the drive touch the **Format** button (below).



A confirmation screen will give you the choice to continue or cancel the process.

! If you do not see your hard drive information, there may be a problem with the connection or drive. Try removing the drive and reattaching the drive. Ensure correct alignment of Master Caddy II or SSDmini.

! The Ninja V uses the exFAT file system for broadest compatibility.

Secure Erase Format

For drives that carry the Atomos Logo such as the G-Technology 4K SSD, Angelbird 4KRAW, AtomX SSDmini by Angelbird and Sony, an option for secure erase is presented. This allows for the entire drive including the drive cache to be formatted. This will erase ALL content on the drive meaning nothing can be recovered. The benefit of this is to optimise performance. It will wipe all data off the drive (which may also be useful as a additional security measure) and reset it back as close as possible to factory conditions.

! When you first insert a drive you may be presented with “Invalid media”. This display means that the drive has not yet been formatted and you simply need to follow the process to format your drive

7. Using the Ninja V - Best Practice

b. Unit Name

To access the unit name tap the **input indicator** from the home screen Information bar.

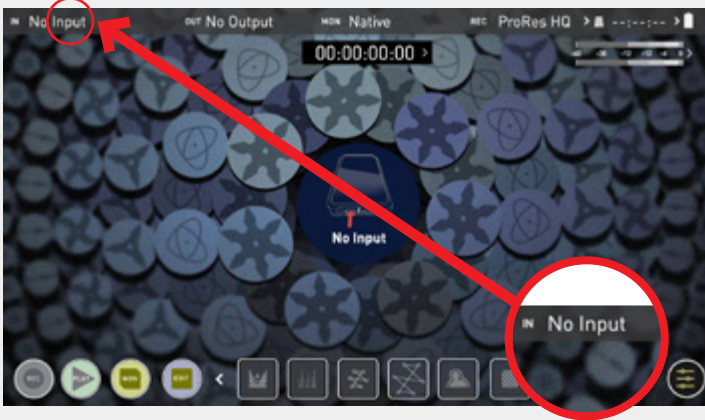

Then navigate to the **FILE TAB**



The unit name serves two main purposes:

- **Drive Naming:** Giving the unit a unique name aids with identification. Once you have given it a name all drives subsequently formatted in the Ninja V will bear this name as a prefix.
- **File Naming:** File name is the current unit name as the start of the recorded clip name; *NINJAV_S001_S001_T001*



- Using the **Select <>** choose the letter to update. The character you are updating will display in the Letter indicator.
- Use the **Letter - +** to change the character. When the correct letter is displayed, use the select control to move to the next character.
- Scene and shot can also be set using the + - controls. Take is automated.

c. File naming

To access the unit name and file naming screen simply follow the steps listed previously in 'b. Unit Name'. Create your own unit name by pressing the arrow to change and enter the letters in. Pressing OK will allocate the new unit name and return you to the menu screen.

This process can be very useful when using multiple devices or with multicam shoots. Good file management now will save you valuable time in post production.

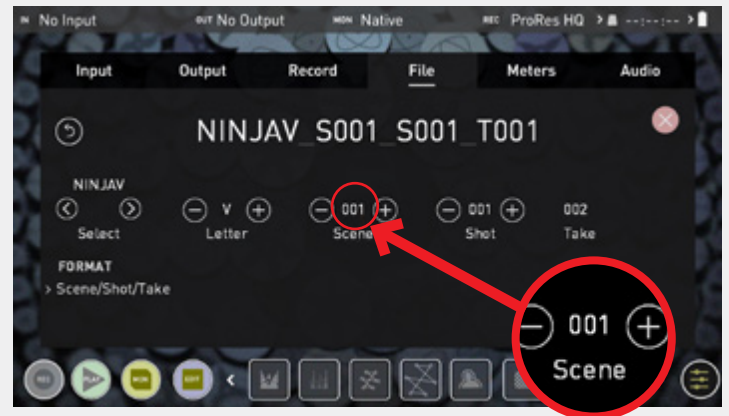

When **changing the drive** please ensure that you take note of the last scene and take number so you can append this as formatting a drive will reset the scene and take counter to 001,001,001.

d. Screen Lock

Lock the Display Screen

You can lock the display of the Ninja V by tapping the power button. This will ensure no changes can be made by mistakenly touching the screen. The screen lock function will simultaneously lock or unlock both Channels of the Ninja V.

Short tap the power button again to unlock the unit.

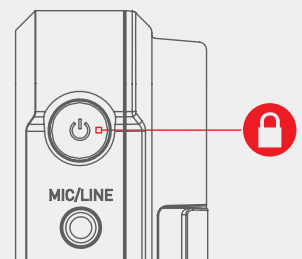
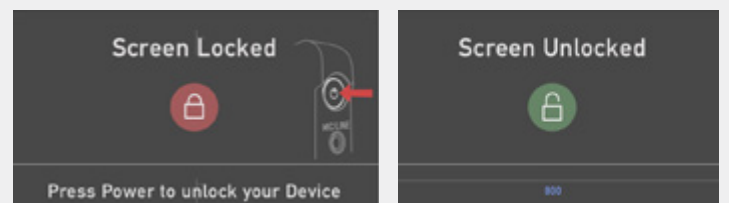

The lock screen can be combined with the display off function so that when lock is engaged the display is turned off. The Tally light on the front of the unit will still display Rec (Red) or idle (green) status. Locking of the display can be found in the Monitor Mode.

7. Using the Ninja V - Best Practice

e. Firmware Updates (AtomOS)

From time to time we will issue software updates for your Ninja V. To update the firmware (that's the software that runs inside your Ninja V), there is a simple procedure you have to follow.

- Check your current Firmware version
Navigate to the Info tab by first pressing either the input, output, codec or media indicators and then navigating through the menu. If at first you do not see the info tab, swipe the tabs bar to the left to reveal more menus and settings.



Swiping left to reveal more tabs, more icons, and more settings is a new feature of AtomOS10. If you cannot find the menu you are looking for, swipe left or right.

The info screen contains the firmware version number and other important information about your Ninja V. To determine if your device is up-to-date or if a firmware update is required.

- Go to www.atomos.com/support
 - Locate and download the firmware upgrade
1. Extract the file ATOMNJV.FW from the firmware zip file.
 2. Copy ATOMNJV.FW onto a drive in a Master Caddy.
 - a. Atomos recommends you use a freshly formatted compatible drive.
 - b. Always format your drives in the Ninja V first. The Ninja V formats the drive for optimal performance for video.
 - c. Ensure that the firmware update file is on the root of the drive, and not in a folder on the drive.
 3. Use a freshly charged battery on your Ninja V or connect to mains power. It is very important that your Ninja V does not lose power during a firmware upgrade.
 4. Power down your Ninja V.
 5. Insert the Master Caddy with the ATOMNJV.FW file.
 6. Power up your Ninja V with a short press of the Power Button.
 7. Watch the screen. The Atomos logo will appear, and then be replaced with a Please Wait message and after a few seconds the firmware upgrade will start.

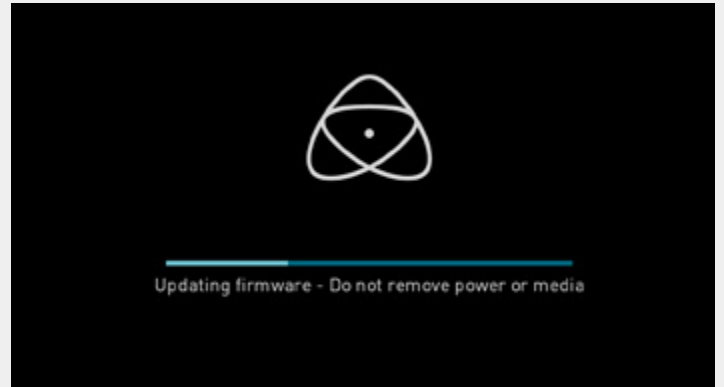

8. While the firmware upgrade is happening, an 'updating firmware' screen will appear.
9. The firmware upgrade will take up to a few minutes.
10. When the firmware upgrade is finished, the Ninja V will:
 - a. Delete ATOMNJV.FW file from your drive.
 - b. Power itself down.
11. Turn on your Ninja V again with a short press of the Power Button located on the side.
12. When the Ninja V has booted, Press the Settings Button and then select the Info tab and check that the version number is the version expected.

! IMPORTANT: Problems when installing AtomOS

Very rarely, the firmware update process can go wrong. This might be because of an incomplete or corrupted download.

In the unlikely event of your Ninja V becoming unresponsive, there is a built-in recovery mechanism.

All you have to do is press and hold the on/off button for 10 seconds. If you do this your Ninja V will revert to its factory condition, and you will be able to retry the firmware update later (taking due precautions to identify and remove possible reasons for the failure of the previous attempt).

! Please ensure your batteries have plenty of charge and that you do not interrupt your Ninja V while its firmware is upgrading. You will see a progress bar to the lower half of the screen. When it is finished, the Ninja V will restart and you will be able to use the device as normal. This process can take up to 5 minutes.

! Please make sure that the firmware file is not renamed when you computer unpacks the ZIP file. If you have other firmware in the same folder, the file may become renamed to ATOMNJV-1.FW when unzipping and the update will not work.

! If you place the .FW file on the drive and insert this in to the Ninja V whilst it is turned on, the device will recognise the firmware update and ask if you'd like to apply the update. If you select "ok" the device will shut down and begin the update process.

7. Using the Ninja V

The Main Screen - Home Screen

The new AtomOS10 homescreen is designed for unobstructed monitoring at all times. The clean and uncluttered design of AtomOS10 concentrates the attention on the image, not on the device's operation. From the muted main button controls through to flexible histogram size and positioning, all on screen

controls are non-obtrusive and incredibly intuitive to use. Monitoring tools are only one-touch away, and now allow for a better view of your subject while adjusting monitor-assist functions such as focus peaking and false color. Record, Playback, Monitoring and Edit features are easier than ever to use.

Monitor Mode / Home

SETTINGS

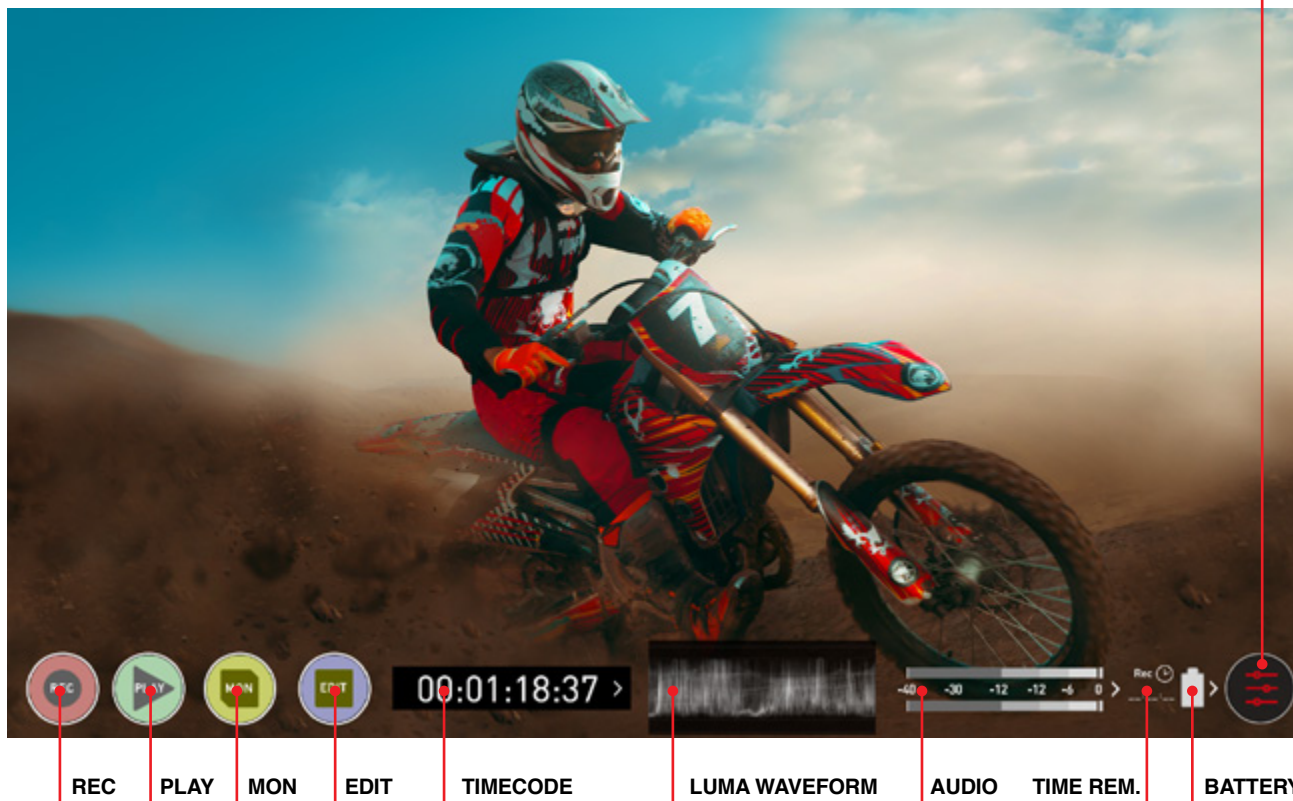

REC (Record):

Press to begin recording. Jump to Record Home Screen.

PLAY:

Jump to the most recently recorded clip on the Playback Home Screen.

MON (Monitor):

Press once to show **Monitoring Features** and **Information Bar**.

See next page for activating Monitoring features.

Press again to return to home.

EDIT:

Press to show **Editing Features** and **Information Bar**.

Press again to return.

TIMECODE:

Shows the selected time code such as embedded, time of day or rec run.

LUMA WAVEFORM:

Luma Waveform is now a constant on your homescreen. Allows for greater control over monitoring without compromising the subject.

AUDIO:

Audio Meters. Touching the Audio meter will open the Audio Menu.

TIME REMAINING:

Time Remaining on Disk (at current record settings). Changing Recording Format will change Time Remaining.

BATTERY:

Touch to access Power Menu. Battery Indicator shows power level and flashes red when power is running low.

SETTINGS (red):

Touch to access all Recording settings, including input, output, file, media, gamma, gamut, and more.

+ **Remove overlays** by touching the center of the screen. Touch again to return.

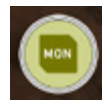

Touch Monitor (MON) to reveal Monitoring Features and Information Bar. When activated the Monitor button will have two surrounding rings. See next page.

7. Using the Ninja V

The Main Screen - Information Bar

At the top of the Ninja V screen is the area referred to as the **Information Bar**. Info here relates to the settings of your input device/camera, Ninja V, media, audio and more. Touching any of these areas will take you to the relevant menu. More info on page 19.

The content of the Information Bar is dependent on what mode you are in, for example Recording and Monitoring will display the Video Input type, but if you are in Play mode, Video Input will show the resolution and frame rate of the video clip currently cued or playing.

Monitor Mode / Features

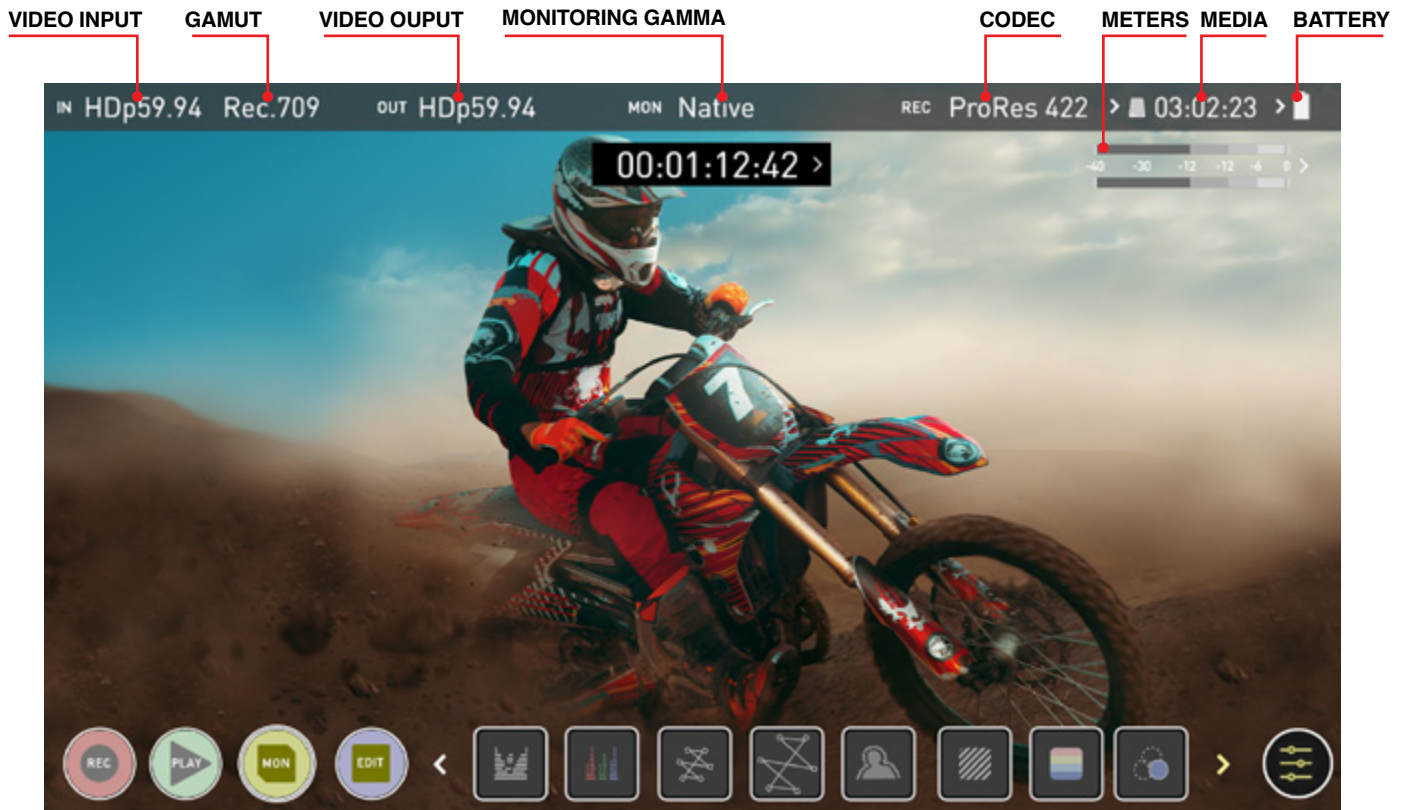

ABOVE: UNIT ENABLED WITH INPUT AND OUTPUT, READY TO RECORD SIGNAL OR PLAY LAST RECORDED FILE FROM DISK

VIDEO INPUT: (Rec & Mon mode)

Resolution and frame rate from input device

VIDEO INPUT: (Play & Edit mode)

Resolution and frame rate of current playback clip

MONITORING GAMUT:

Shows current gamut input applied to the signal from the source device. Touch this control to ensure it matches the output coming from your camera or other input device. During playback mode this setting will be determined by the recorded content.

MONITORING GAMMA:

This shows the gamma which should be set to be the same as the source device. Touch this control to ensure it matches the input coming from your source device. During playback mode this setting will be determined by the recorded content.

VIDEO OUTPUT:

This menu displays the active video format being output from HDMI.

CODEC (RECORDING FORMAT):

Shows the recording format. Touch to change settings.

METERS:

Audio Meters. Touching the audio meter will open the Meters Menu

MEDIA INFO:

This shows the remaining recording time based on the chosen codec and remaining capacity of the drive.

BATTERY:

Touch to access Power Menu. Battery Indicator shows power level and flashes red when power is running low.

SETTINGS (yellow):

Touch to access Monitoring Feature settings.

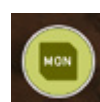

Touch MON again to return to previous screen.

You will find the EDIT button works in a similar fashion, and that it is not possible to have Monitor and Edit active simultaneously.

7. Using the Ninja V

The Main Screen - Monitoring Features

At the bottom of the Monitoring screen are the Monitoring Features, accessible by toggling the MON icon. Monitoring Features do not affect your recorded file and can be turned on and off, or adjusted whilst recording (unless you choose to burn a LUT file into your footage). Not all Monitoring

features are available at first glance – to reveal all Monitoring features, swipe monitoring icons to the left. The icons will behave in a carousel like manner and you can swipe left and right to access any of the features. At the bottom right is the Settings button. Press Settings to adjust behaviours of Monitoring Tools.

Monitor Mode / Features

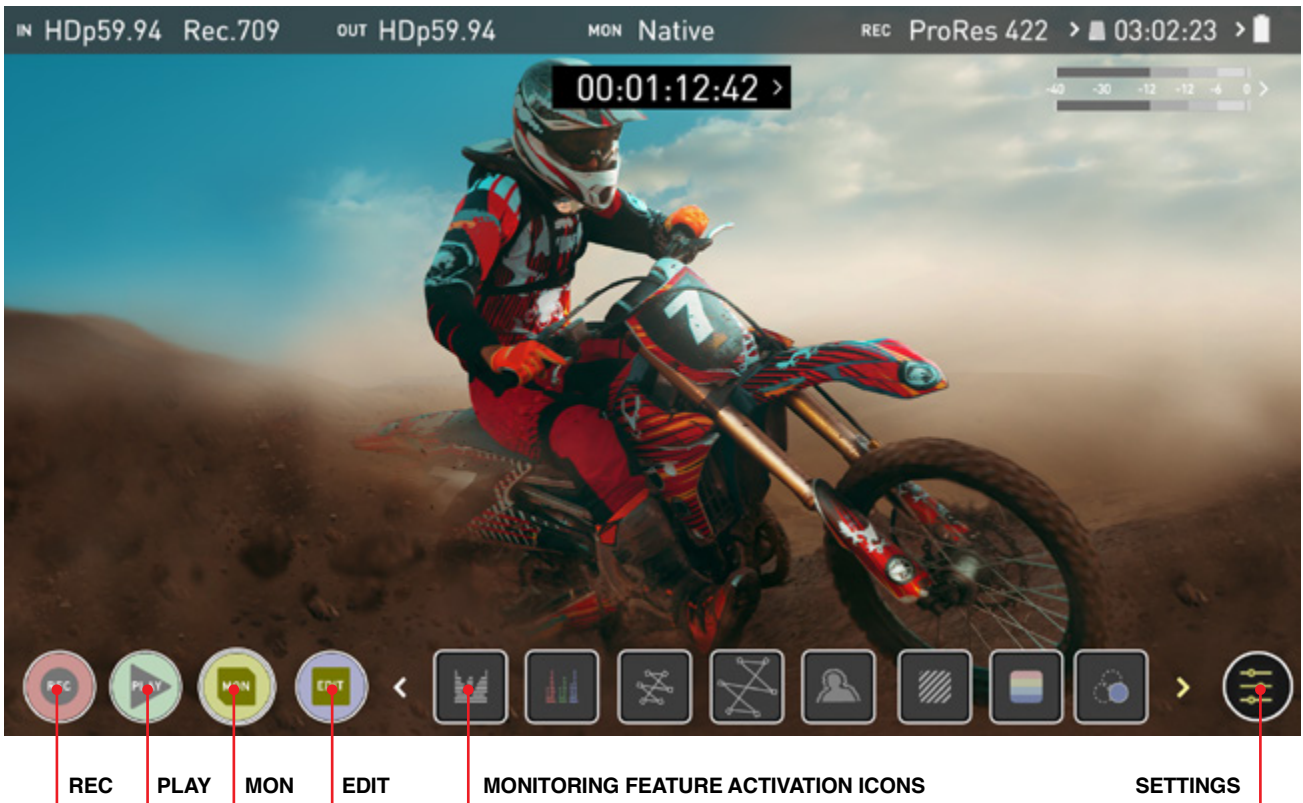

Main Controls

- REC (Record):**
Press to begin recording. Jump to Record Home Screen.
- PLAY:**
Jump to the most recently recorded clip / Playback Home Screen.
- MON (Monitor):**
At this screen, press once to revert to home screen view.
For Monitor settings press the Settings button. Any Monitoring functions you have enabled will remain active until deactivated.
- EDIT:**
Press to show **Editing Features** and **Information Bar**.
Press again to return to home. Any Monitoring functions you have activated will remain active until they are turned off.
- SETTINGS (yellow):**
Touch to access Monitoring Feature Settings. Set histogram sizes, adjust transparency, LUTs, Focus Peaking and more.

MONITORING FEATURE ACTIVATION ICONS:

Luma Waveform	RGB Parade	Vectorscope	Vectorscope Zoom
Focus Peaking	Zebra	False Color	Blue Only
Zoom In	Zoom X 2	Safe area	Guides
	Swipe left to reveal		
Desqueeze			Settings

7. Using the Ninja V

Home screen and menu functions

REC (Record)

This is the icon you touch to begin a recording. Touch it again to stop a recording. While recording the Rec icon changes to a Stop icon and a red frame is present around the screen.

Standby



Recording

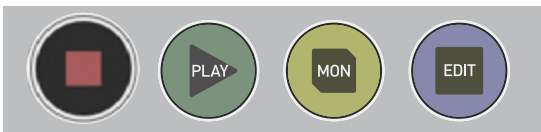

No input / No media



 The Rec icon is dimmed and disabled if there is no valid video input OR, the disk is not formatted, or the disk is full. The button is dimmed because you cannot record.

PLAY

Touch this icon to play previously recorded clips. When you press the green Play button the Ninja V will switch to playback mode and automatically play the last recorded clip.

Playback mode

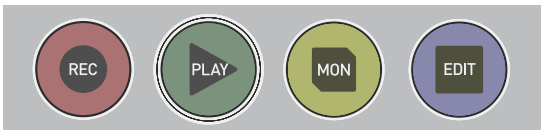

Playback Home screen

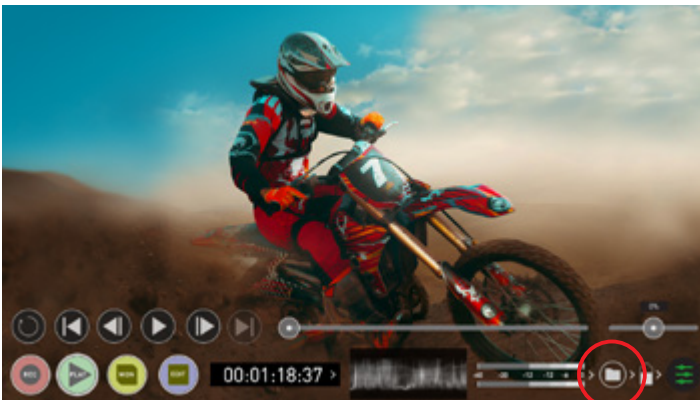

Touching the folder icon will reveal the available playlist. See next image.



Ninja V uses a unit name, scene, shot and take convention to name the clips. Select the clip you want to play by touching the file name and this will start to playback. To exit the playlist simply touch close, or any other button. Touching close will take you to the previous window.



Close playlist



folder level up



Playlist options

No disk / disc not secure



 The Play button will be dimmed and disabled if there is no content, no disk, a poor connection or the disk is not correctly formatted. **See page 14 - Format Media**

MON (Monitor)

Pressing MON reveals Monitor Assist icons as shown on previous page. These features are explained in detail on page 25.



EDIT

You can use the edit tools during recording and playback. Pressing EDIT takes you into a number of options which will be explained later on page 37.



7. Using the Ninja V

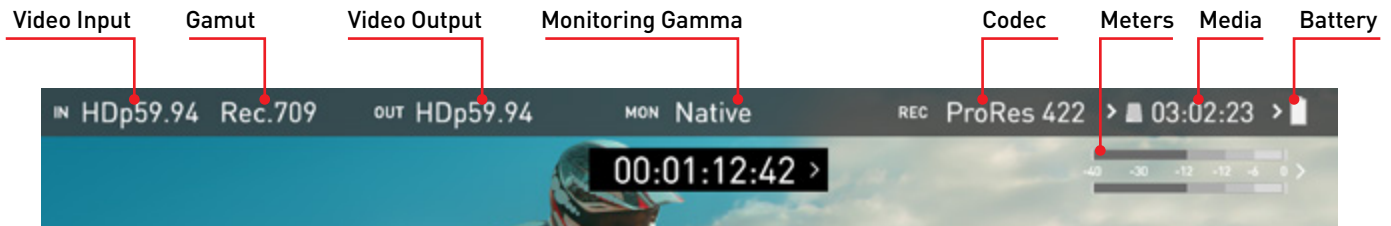

Information Bar - Adjust your settings

The **Information Bar** of your Ninja V displays the settings of your input device/camera, current settings of your Ninja V, media, audio, disk capacity and more. Touching any of these areas will take you to the relevant menu and allow you to make changes to your setup.



Alternatively you can access these settings by tapping the Record Settings icon. Tapping the Settings button will open the Record Settings menu, from where you will be able to navigate to the required tab. Swipe left to see more tabs.

Input

Video Input

Simply tap the source input menu to the top left of the screen to bring up the input control panel. This panel is a command center for all devices connected to the Ninja V and will assist you with connectivity by indicating if the signal is active or if attention is required.

SOURCE

The current input resolution and framerate of the selected input source is displayed.

DEVICE

HDMI Devices will display an EDID Device name if the information is available from the HDMI device connected. Not all cameras carry an EDID device name. For cameras such as the Panasonic Lumix GH5 this will display as 'Unknown'.

A green tick on Source indicates the Ninja V has locked signal on this input, a red cross indicates a signal or lock issue with the attached device, double check your cable and camera output settings.

TRIGGER

The Ninja V can be remotely triggered to record from your camera. Select the correct triggering option for your camera and set Enable Trigger to ON.

CAMERA OUTPUT

For the best image processing results it is essential to match the Ninja V settings to the camera/input settings. Choose to use Log/HDR, camera type, Gamma, Gamut or enable HDMI HDR auto if required. Your Ninja V will recognise most cameras when correctly attached via a compatible HDMI cable.



Log/HDR: Turn on to enable HDR image processing inside the Ninja V. Bring the control of post into your shoot - record, preview and review using HDR.

Camera: Tap to scroll through to the manufacturer of the camera providing the input. Sony, Fujifilm, Canon, Panasonic, ARRI, RED and JVC.

Log Gamma Format: For each manufacturer there may be a number of different Log curves available and you can scroll through to the correct selection by tapping the Gamma icon.

Gamut: Select the Color Gamut of the input. This is not applicable to all cameras but again ensure that this matches the input of the camera to ensure accurate monitoring.

HDMI HDR Auto

HDR is detected when there is a compatible input signal. It is important that this is OFF if the camera is not outputting HLG or PQ. It should not be used for regular Log.

About Log/HDR

A better understanding of Log and HDR will enhance your workflow and ultimately allow you to capture maximum amount of detail during recording, and save you time in post production. To understand more about the importance of this function please see page 32.

7. Using the Ninja V



Output

Output

This menu displays the active video format being output from HDMI. A 4K to HD down conversion can be applied to the output. This enables you to send a 4K input signal to a HD device. When working in HDR a signal will be output with the correct HDR flag to activate a compatible HDR display's settings. This can be useful if you wish to monitor log footage in the studio.

VIDEO OUT

this option will show the resolution of the Input. When processing options are applied below it will be adjusted accordingly.

OUTPUT OPTIONS

4K or UHD inputs can be scaled for output using the first option. This will scale 4K to 2K and UHD will be scaled to HD 1080p. The 4K DCI crop will trim the 17:9 DCI input to 16:9 converting the signal to UHD or with the other option selected down scale to HD.

HDMI timecode allows for the embedded time code or in unit generated time code to be looped out. The option is present to allow you to turn the time code of as this can disrupt some consumer equipment that is not intended to receive embedded timecode.

HDR

Here you are able to set a conversion from your LOG input to a HDR display standard such as HLG or PQ. You can also define the output color gamut from your camera's gamut to a display standard for BT2020, DCI-P3 or Rec709.



Record

Record

Pre-Roll



With this option turned on you will see a red Pre-Roll icon flash in the top left hand corner and a white circular arrow around the record button. Whilst enabled the input is constantly been recorded with approximately the last 8 seconds in HD and 2-3 seconds in 4K being cached into memory. The frame rate and codec selected will determine the number of seconds being cached for Pre-Roll. Using a lower bit rate codec setting and shooting at lower frame rate will increase the length of Pre-Roll.

When the record button is pressed or trigger is sent, the buffered Pre-Roll data in memory will be written out to the start of the recording. This means if you are few seconds slow hitting the record button when something interesting happens you will still capture the shot.

With Pre-Roll mode activated the Recorder is constantly caching frames internally to the unit and as such any feature that can not be changed whilst recording is disabled. This includes audio channel select, 3D LUT record, codec, disk options etc.

CODEC (Recording Format)

To select a codec simply tap on the currently displayed codec to toggle between ProRes® or Avid DNxHD®*. The Quality menu allows you to toggle codec compression. Apple ProRes offers 3 levels of compression (HQ, 422 & LT), DNx offers 4 (220x, 220, 145, 36) and DNxHR is available in HQX, HQ, SQ and LB. The expected record time available from each codec selection is automatically calculated from the available space on the media inserted.

ProRes Avid DNxHD®

***If Avid DNxHD / DNxHR is required, you must activate it first. This can be done at www.atomos.com/support – DNxHD 220x/DNxHR HQX are 10bit, all others are 8 bit, DNxHD36 is a proxy codec.**

More information regarding Apple ProRes data rates can be obtained online from Apple ProRes whitepaper PDF document.

7. Using the Ninja V



Record

PULLDOWN

The record menu allows you to apply pulldown removal if recording from a source that applies pulldown to the output signal. Note for 3:2 Pulldown removal, movement in the frame may be required to accurately lock signal, simply wave your hand in front of the camera to achieve lock. See **page 44** for more details on pulldown removal.

SPACE REMAINING

Indicates the total recording time remaining on your HDD/SSD media at the current settings. Changing your recording settings may extend or decrease your available recording times.



File

File Naming

Allows you to dictate the scene and shot number that will be recorded as well as the ability to change the unit and media name. By default unit will be named NINJAV.

To change the unit name tap the arrow under UNIT/MEDIA NAME, Use the left and right arrows to select a letter, and the up and down arrows to change it's value. Refer page 13 for more info.

To modify the scene and shot number under File Naming, select plus or minus next to scene or shot (up to 999). The number you choose will then be shown in the file name at the top of the screen during recording, the take number is automatically increased with each take.

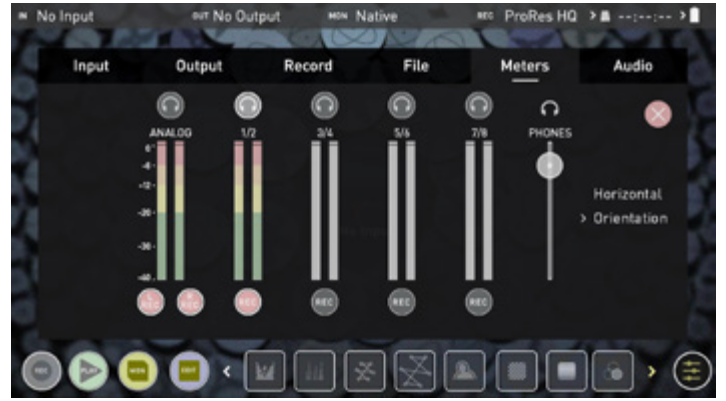

Meters

Meters

The meters and audio settings are easily accessible by touching the audio meters (shown below) on the record, monitor and playback home screens. Touching the meters will take you directly to the Meters menu.



For monitoring the audio there are two types of display available. Access this setting on the meters page. Options available are:

Horizontal

Displays the 2 channels you are actively monitoring.

Vertical

Displays 8 channels + 2 Analogue Channels.

Monitoring Audio



To monitor the audio, tap the headphone icon next to the channel you wish to monitor from the headphone output. Only one channel (stereo pair) may be monitored at any time using headphones (you can monitor all visually). It is possible to record multiple channels by checking multiple REC buttons

🚩 Selecting the Monitor icon does not mean that track is selected to be recorded. You need to select each channel using the **REC** record button. Tracks that are selected to be recorded have colored Audio Meters. See image above.

🚩 Please note that if analogue audio is recorded it will be placed as track 1-2 with embedded audio moving to 3-4. Note if analogue channels are turned on but no audio is present, in many video players you will not hear silence as they often just play the first stereo pair. In an NLE you can easily access all the recorded tracks.

7. Using the Ninja V



Audio

Audio

Audio Input Options

To adjust the gain on the analogue input you need to bring up the audio options page by pressing in the lower right corner of the audio menu.

To select the input line Level to match your device.

Options available are:

- **Line Level (-10 dBu)**

Sets the analogue input channel to Line Level via the 3.5mm audio jack.

- **Mic Level (-40 dBu)**

Sets the analogue input channel to Mic Level via the 3.5mm audio jack.

Analogue gain can then be tuned by incremental increase or decrease of up to +/- 20dB individually for both left and right channels.

 *It is not possible to vary the gain if the signal input is from the HDMI connection because this is digital and is embedded in the signal. You can usually adjust this from the camera, please see your camera manual for operational details.*

 *Ninja V Mic input supports dynamic and powered microphones only. When using these, audio must be set as Mic Level*

Audio Delay

This option allows you to delay the Audio to be in sync with the video by adding in frame delays.

Audio during Playback Mode

When you enter into Playback mode on the Ninja V it will only output channels 1/2 on the headphones, please bear this in mind when you select the audio channels for recording.



Media

Media

Media menu shows current media type and capacity. Format disks from this menu. See Format Media on page 12. Information about compatible drives is available at atomos.com/drives



Timecode

Timecode

Using Timecode

The timecode display changes position depending on the screen mode you are using. In monitoring mode it appears in the center top, below the info bar. In home screen mode the timecode display sits on the bottom near the REC PLAY MON EDIT icons.

Touching the Timecode display on the home screen, just below the information bar will take you to the Timecode setup screen.

The Timecode modes supported are:

- HDMI (Embedded)
- Record Run
- Time of Day
- Auto Restart

Cycle through these modes by touching the Timecode Source Selector.

7. Using the Ninja V

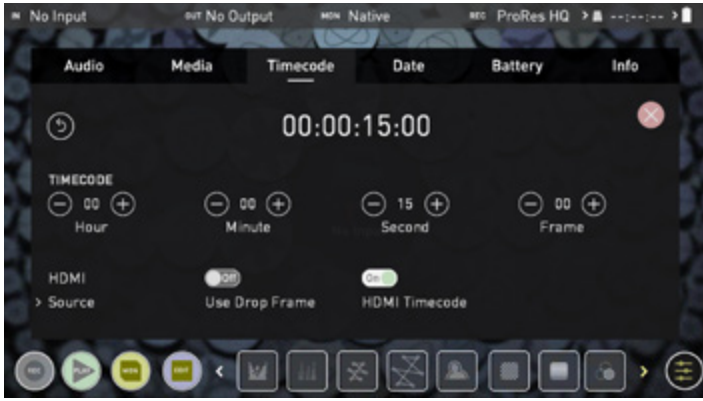

Timecode

Timecode modes:

HDMI embedded Timecode

With this setting, the HDMI input will use the Timecode embedded in the input signal. The controls to adjust the Timecode value are disabled in this menu as you will need to adjust these on the camera. Note that not all HDMI sources embed Timecode.

Trigger from HDMI Timecode

If HDMI timecode is selected and the camera is in REC RUN mode, the user has the choice to start and stop recording remotely from the source camera timecode.

To enable rolling Timecode Start/Stop functions, simply set the HDMI Timecode switch to on. When enabled, pressing the camera Record Stop/Start button will make the Ninja V start and stop record simultaneously as the timecode starts and stops.

 *When using the camera in Free Run timecode, the rolling timecode trigger might not work as expected.*

 *Note that whilst camera triggers are also looped out on HDMI not all wireless systems carry the trigger on to other devices so it's worth testing your system before a shoot if you plan to use it in this way to record proxies.*

Time of Day

With this setting, each new clip that is created will contain embedded Timecode starting with the time of day when the recording is started. Please check that Ninja V clock has been set correctly.

This can be set in the *DATE* menu

 *If recording is stopped and then restarted while in this mode, there will be a time gap between the last clip and the next one, equal to the length of time the Ninja V has been out of record.*

 *In Time of Day mode, the controls on the Timecode Setup Screen for adjusting the start-point of the Ninja's Timecode are not available, as the Timecode is set by the Ninja's internal clock.*

Record Run

With this setting you set the starting Timecode for the first clip. The following clips will start at the frame immediately after the out point of the preceding clip. This will continue for all clips that follow. This is also known as continuous Timecode.

Auto Restart

With this setting, the Timecode will be reset to the Timecode you have defined whenever you press record. All your clips will start with this same Timecode.

 *To adjust the Timecode use the "+" and "-" above and below the hour:minute:seconds sections*



Date

Date & Time

Allows you to adjust the date and time shown by the clock in the Ninja V. This will also change the time of day Timecode. Touching the Date & Time takes you into the Date and Time Screen.

Date formats (i.e. dd-mm-yyyy or mm-dd-yyyy) are selectable by tapping the blue arrow on "Select Date Format" Menu. Simply keep tapping until the desired format is shown. The Time, Month, Day and Year are selectable and can be modified by clicking the blue plus and minus icons next to the desired fields.

7. Using the Ninja V



Battery

Battery

The Battery icon on the left of the screen indicates the remaining power in the attached battery.

In the center of the screen is a 'power down' button. Hold down for 4 seconds to shut down the unit.

When using the supplied Battery Eliminator, the remaining power indicator will remain green and show 100% full. The displayed voltage will be determined by the input source. Refer to your Ninja V quickstart guide for more information regarding battery life.

 When a battery is running low the battery icon in the upper right corner of the screen will flash and warning menus will appear at 25% and 10%.

Info

Info

Shows the software (firmware) version and unique device ID (DID) of your Ninja V device. This will be required to activate the Avid DNxHD / Avid DNxHR codec. You can also check on the Atomos website to ensure you are running the latest firmware: www.atomos.com/support

8. Monitoring & Recording

Setting up for recording

As soon as you connect a supported signal to the Ninja V input and have inserted a formatted drive the following will happen;

- The **REC** icon will be illuminated (red)
- The input source & format will be shown in the top left corner of the information bar
- Audio input meters will be responding to source.

Ready to Record (monitor mode/home)

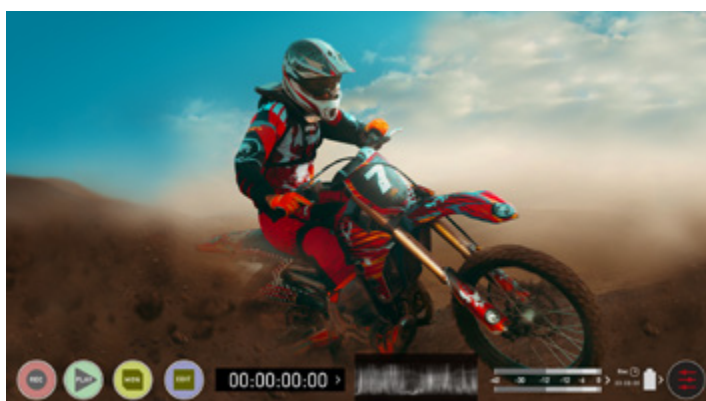

Ready to Record (monitor mode/features)



No Input / No Disk / No Disk Formatted



SmartControl

SmartControl is a versatile set of functions used to control the starting and stopping of recording by automatic or external means. This section outlines the different methods to start and stop recording.

Ninja V Start and Stop record control can be triggered by the following methods:

1. Home Page Touch Screen
2. HDMI Rolling Timecode trigger
3. HDMI Camera trigger
4. Via LANC for Sony and Canon Cameras
5. Via LANC serial port

 Some cameras perform optimally when triggering from the camera and not the recorder.

1. Home page Touch Screen

By pressing REC (Record) and STOP to end recording



2. HDMI Rolling Timecode Trigger Record

If the camera is Record Run mode, recording can be stopped or started by a moving Timecode via HDMI.

When enabled the camera and the Ninja V will start and stop recording simultaneously.

 Rolling Timecode trigger is for use in older cameras with TC only and no trigger. If your camera is set to FREE RUN this trigger will start recording immediately. Please be that aware not all cameras have Start/Stop flags for triggering record, especially older cameras. In such cases rolling trigger in REC RUN will need to be used to trigger recording automatically at the same time as the camera starts recording.



3. HDMI Camera Trigger Record

The HDMI Camera trigger is available for supported cameras, There is a flag within the digital signal that lets the Ninja V know the start/stop record has been pressed on the camera; in turn this will trigger the Ninja V to start/stop recording at the same time as the camera.

8. Monitoring & Recording

Monitoring Features

At the bottom of the Monitoring screen are the Monitoring Features, accessible by toggling the MON icon. Monitoring Features do not affect your recorded file and can be turned on and off, or adjusted whilst recording. Not all Monitoring features are available at first glance.

To reveal all Monitoring features, SWIPE MONITORING FEATURE ICONS TO THE LEFT. The icons will behave in a carousel like manner and you can swipe left and right to access any of the features. At the bottom right is the settings button. Press Settings to adjust behaviours of Monitoring Tools.

Monitor Mode / Features



Monitoring Features Activation Icons

AtomOS 10 features a new and improved layout of Monitoring tools. These can be toggled on and off simply by touching the large yellow MON icon. When Monitoring tools are displayed, swipe left to reveal more icons. Tapping on the icons will enable each features. Many of tools can be used simultaneously to assist with focus, exposure, framing and more. Here is a quick guide to what each icon represents.



Luma Waveform

A great way to visualize the dynamic range of your image.



RGB Parade

Monitor the level of red, green and blue from an input source.



Vectorscope

This is useful for checking if an image is under or over saturated.



Vectorscope Zoom

8x of the center of the vectorscope.



Focus Peaking

Ensure your recordings are always in focus.



Zebra Pattern

Use Zebra to check exposure and set exposure levels.



False Color

A visualization of exposure across the image.



Blue Only Exposure

Observe the noise content of a video image.



Zoom 1:1

Punch in and check critical focus.



Zoom 2:1

Toggle 2:1 to magnify the screen.

8. Monitoring & Recording



Cinema Guides

Cine or TV frame guides.



Safe Areas

Action area and title safe areas displayed.



Anamorphic Desqueeze

Allows you to see a correctly squeezed image when using anamorphic lenses



Settings

Press to access settings for monitoring tools

 The Monitor Features will only be illuminated and available if there is an input signal detected.

Using Waveform Monitoring tools (WFM)

Luma Waveform

The Luma or Luminance Waveform is a great way to visualize the dynamic range of your image, allowing you to protect exposure of both your highlights and shadow detail. It's particularly useful when shooting with a low contrast LOG curve and works in perfect partnership with HDR to illustrate the highlight clipping point to allow you to correctly expose your image.



RGB Waveform

RGB Waveform will monitor the level of Red, Green and Blue from an input source. The RGB channels are displayed side by side and each channel color is shown under the corresponding waveform. This can be used to check to the white balance. Just point the camera at something white and the Red, Green and Blue levels should match if white balance is setup correctly on the camera.



 The Waveform Monitor will remain on screen when hiding the overlays ensuring the focus remains on calibrating your image. If the MON button is pressed the WFM will move in to the bottom icon line up.

Vectorscope

The Vectorscope display shows color information of hue (shown as a phase vector), and saturation (measured by outward distance from the center). This is useful for checking if an image is under or over saturated and for calibrating multiple cameras to ensure greater consistency between shots.



Vectorscope Zoom

The Vectorscope Zoom shows a scaled up view (x8) of the center of the vectorscope.



Waveform Monitor Settings

 To access Waveform Monitoring settings simply touch on the Settings icon and select the **Waveform Tab**.

To change the size of the waveform, press on the 1/4, 1/3 or Full Screen icons and the display will update immediately.



Waveform Size settings

 To toggle between Waveform Monitor sizes of 1/4, 1/3 and Full Screen during monitoring, recording and playback, tap in the bottom left corner of the screen. You can also adjust the brightness and opacity of the waveform display whilst recording, monitoring or during playback.

8. Monitoring & Recording

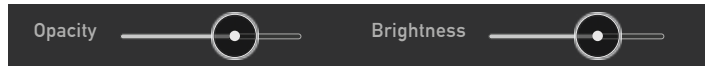

The Brightness slider directly controls the intensity of the waveform while the opacity slider adjusts the transparency values of the waveform display on screen. Experiment with these controls to achieve your desired monitoring setup.

Using Monitor Assist tools

AtomOS10 features monitoring tools that help with making your shot picture perfect. Easily access Focus Peaking, Zebra, False Color and Blue Only Exposure to check image is in focus, noise free and correctly exposed. Options for safe area/ title area markers along with aspect ratio markers and anamorphic desqueeze functions are also available.

Focus Peaking

Focus peaking allows the user to ensure their recordings are always in focus. The parts of the image in focus are highlighted by the selected color (can be adjusted by dragging the slider). There are a number of options for how peaking is displayed, it can be overlaid over the color video image, over a greyscale image or just show the peaking by selecting the corresponding icon.

Focus Peaking Color



Focus Peaking Mono

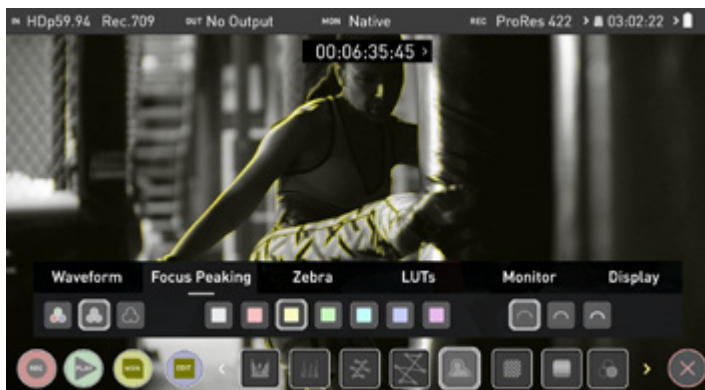

Focus Assist Outline

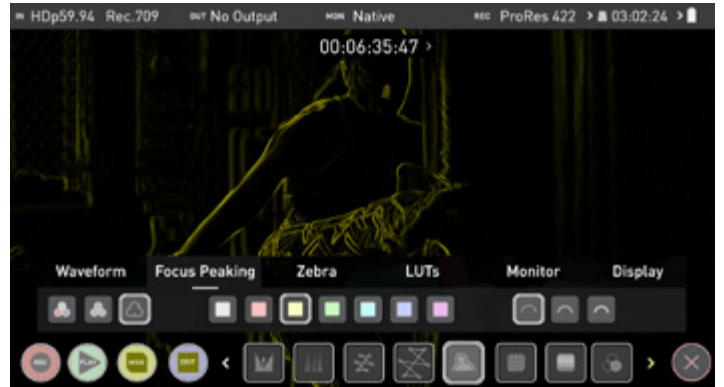

You can change the focus peaking colors and modes by touching the icons in the focus peaking menu.



Zebra Threshold

Zebra pattern show the parts of the image that are exposed $\pm 5\%$ of the target level set. The Zebra threshold value can be adjusted by moving the slider left or right.

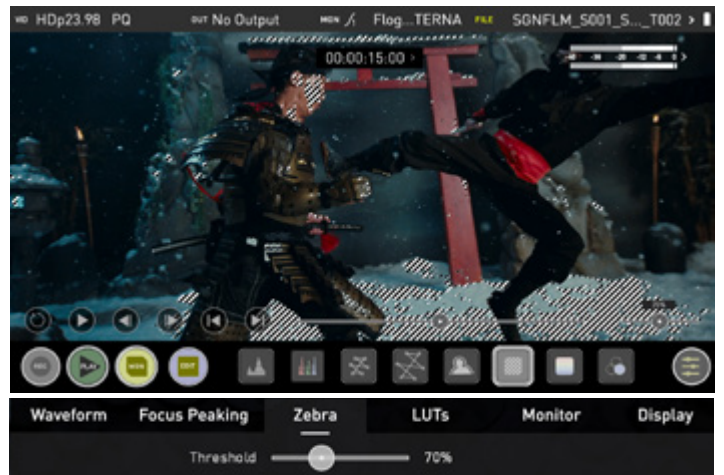

False Color

False Color assigns different colors to areas of different brightness in the image. This gives a visualization of what is going on with exposure across the image. There is a scale on the left hand side, overexposed elements will display as red, and underexposed elements will display as blue.

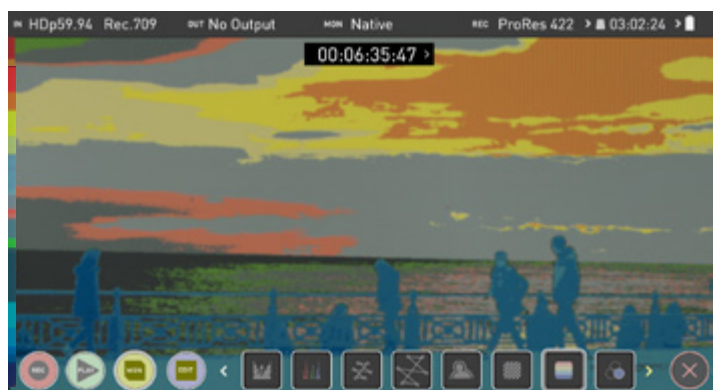

8. Monitoring & Recording

False Color Scale



To help you determine the exposure range with more accuracy, please use the scale on the left hand side of the display.

Blue Only Exposure

Blue only displays a greyscale image based on the blue channel of the input signal. This is useful to observe the noise content of a video image as sensor noise is most visible in this channel.

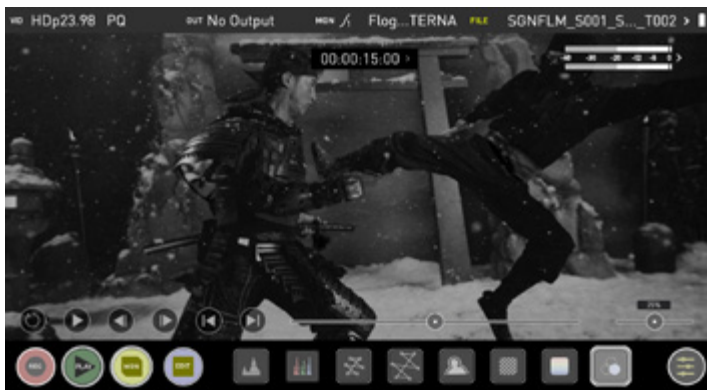

Zoom

Zoom mode enables you to punch in and check critical focus



Toggle 1:1 to display 1:1 pixel mapping, the indicator box shows the location of the screen you are viewing.

- 4K 1:1 shows 1/4 of the 4K UHD image.



Toggle 2:1 to magnify the screen, the indicator box shows the location of the screen you are viewing, you can move the zoomed location by dragging across the screen or selecting a portion of the indicator box.

- 4K 2:1 shows 1/16 of the 4K UHD image.

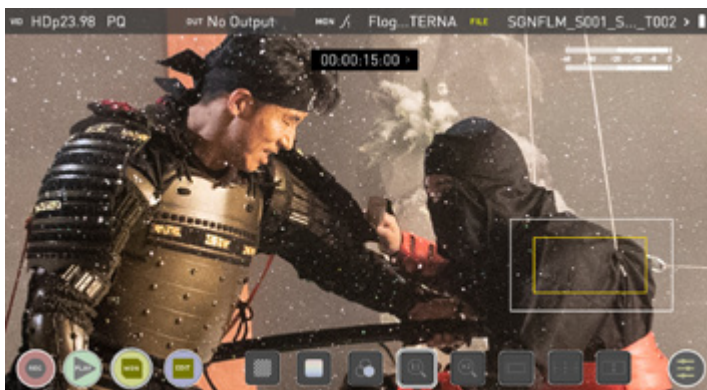

Cinema Guides / Safe Areas / Anamorphic De-Squeeze

AtomOS 10 has advanced frame guides and safe areas. You can cycle through your required cine or TV frame guides by repeatedly pressing the guides icon. Action safe area and title safe areas can then be turned on and are proportional to the frame guides based on SMPTE standards.



Cinema Guides

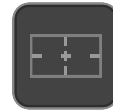

Safe Areas



Anamorphic De-Squeeze

To enable the guides press the Cinema guides icon to cycle through your chosen aspect ratio. The aspect ratio markers are very useful with the 2 x Anamorphic De-Squeeze to preview and crops that could be made in post. To turn on the safe area markers tap the Safe area icon once for the Action area and again for the title safe area.

Cinema Guides



 The Safe Area/Grid Lines will still be visible when tapping the center of the screen to hide the overlays.

Safe Guides



Desqueeze 2x



8. Monitoring & Recording

LUTs

A LUT or **Look Up Table** is a table that transforms the color response and as such adjusts the 'Look' of the input. 3D LUTs have a combination of three inputs defining the combination of R, G, and B values allowing for adjustment of not only color but also gamma and gamut. LUTs can also be used to monitor the input in a specific color space or more creatively to create a specific 'look' such as film stock emulation or to match cameras.



It's worth noting that not all LUTs are equal and the majority of LUTs are designed to work within the boundaries of REC.709. This means that whilst they may apply the color adjustments you are looking for they may also effect the luminance of the image and in which case these LUTs should only be used for delivery of content designed to be viewed in REC.709 or SDR. If you are working with 3D LUTs you can use color correction applications, as well as applications like Davinci Resolve, Photoshop or dedicated applications like LUTCalc. to create your own custom Looks that can then be imported to your Atomos device. They can provide a great base or primary grade that allow you to apply an instant look to your footage.

Atomos support 3D LUTs in the industry standard .CUBE format and provides 8 LUT memory slots for you to load your LUTs into. 1D LUTs are not supported and will need to be converted via 3rd party software to be imported.

To import LUTs into your Ninja V first copy the .CUBE files on to the SSD/HDD in your Master Caddy II using a computer and compatible dock.

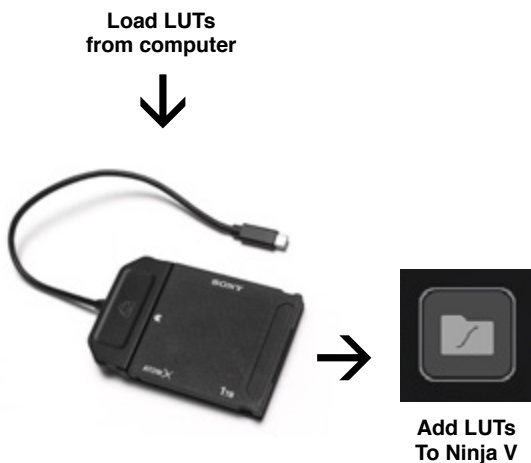

To load a LUT select the desired slot (curve button) and press on the curve icon and then tap the folder file. Navigate via touching through the disk file system to the LUT file to be uploaded, press on the name to select the LUT and then again to import.



Then wait for the LUT loading progress bar to complete. The name of the currently selected 3D LUT is displayed at the top of the Monitor Mode panel.

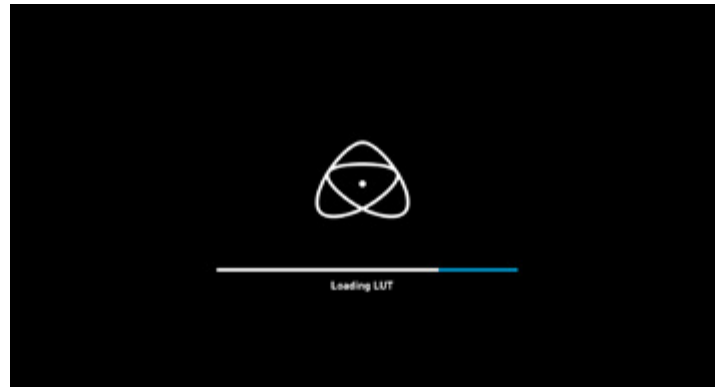

This LUT can then be applied to the display by selecting the correct LUT memory slot. **The LUT needs to be activated in the Monitor Features Menu.** Activating the LUT in the Monitor menu will always use the LUT selected in the LUTs menu. Touching the activated LUT name in the Information bar will give you instant access to LUTs selection.

Inside the LUTs menu touching on the slots will preview the name of the selected LUT (above the Menu bar). The selected LUT filename will also display in the Information bar.

8. Monitoring & Recording

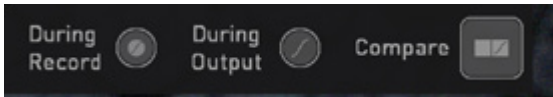

3 options that relate to the processing of the LUT:

During Record

If this option is selected the recording it will bake the LUT look into the recording and this is a **non-reversible process**. It cannot be undone in Post so we advise you consider your workflow before the use of this option. When enabled, a CUSTOM LOOK icon will flash in the top corner of the monitor and the LUT cannot be activated during recording to avoid any potential issues with the recorded content.

During Output

OUTPUT LOOK – With this option the selected LOOK is also applied to the HDMI loop out of the Ninja V. This will allow for instant preview on a larger monitor or to be used with a wireless sender. This function can also be combined with the down convert option that can be found in the input menu.

Compare

During color management it's likely that you may want to review a number of LOOKs and even compare them to the Native Video Source. Tapping the Compare option will apply a 50/50 vertical screen split that will show both the Natural Source Video and the selected LOOK of the LUT.



Please note that activating the 50/50 preview will also be applied to the Loop out and is not available when LUT is set to record.



Remember by simply tapping the center of the screen you can remove all overlays. Tap again to reveal controls.



Monitor

Before entering into the operation of HDR monitoring it is important to understand the background of HDR. We advise that you read the Atomos HDR Guide to familiarise yourself with the key terms and differences between the existing Rec.709 standard dynamic range (SDR) and the future way we will view images in High Dynamic Range (HDR).

Using Standards - Native / Rec.709 / HLG / PQ

AtomOS10 uses predefined settings to display your video when viewing in HDR. This is similar to the HDR slider in previous Atomos Operating Systems, except instead of a variable slider control, we have now buttons that correspond with Rec.709 (SDR), HLG and PQ (HDR) levels.

Activating these buttons will display your video according to the levels indicated below, allowing you to adjust your exposure accordingly and take the guess work out of exposing correctly for HDR.

NATIVE Native Video Source

This option will display the video source without any processing and the Ninja V will behave as expected for a standard broadcast monitor. When connected to a camera this means the image you are viewing is the untouched camera output eg. a standard Rec.709 image or a Log image etc. A standard Rec.709 image will look correct and a Log image will look flat.

REC 709 Rec.709

With this mode selected the Ninja V will map from the camera gamma/gamut so that 100% linear IRE maps the panel's white (1000nits). Everything above is clipped.

HLG HLG (Hybrid Log Gamma)

With this mode selected the Ninja V will map from the camera gamma/gamut so that 1200% linear IRE maps the panel's white (1000nits). Highlights are slightly compressed.

PQ PQ

With PQ mode selected the Ninja V will map from the camera gamma/gamut so that 2000% linear IRE maps the panel's white (1000nits). Highlights have more compression and look similar to HLG, but closer inspection will reveal more detail is visible in specular highlights.

Your camera's dynamic range will determine how much more detail is visible between HLG and PQ modes.

8. Monitoring & Recording

Understanding HDR and Log

The first step in HDR is to recognize you have a HDR scene. Look for a good range of contrast across the brightest and darkest parts of your image and also across the color and tonal range as each color also contains its own brightness or luminance information.

Secondly ensure you are sending a Log signal into the Ninja V so that you are recording the HDR Log information (See page 19 for more info).

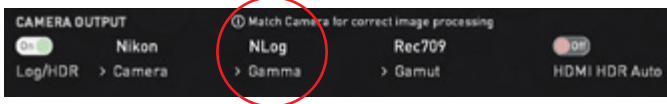

Now you are ready to capture Log and simultaneously use AtomOS10 image processing to preview the final HDR result in the field, rather than dealing with the washed out look of Log for critical exposure decisions.

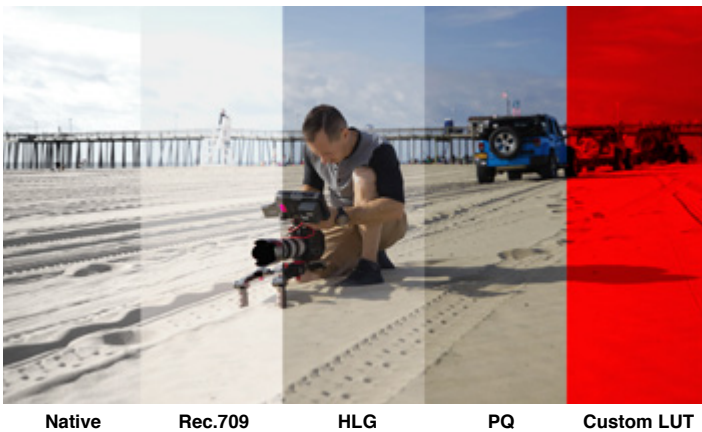

The main impact of HDR is apparent in the specular highlights and bright areas. The areas that would have previously been 'blown out' will now contain visible detail and information to enhance your content. HDR provides more headroom allowing you to show more detail. Experimentation with increased exposures is encouraged.

AtomOS10 HDR uses an in depth understanding of each Log curve and combines it with the control of the panel processing and backlight in order to apply an increased brightness to the highlight areas of the scene.

 *Alongside the physical light in the scene, the faster/brighter your lens the greater the level of brightness you'll have to play with. Choosing a Cine style lens or those with a declicked manual aperture can provide increased flexibility over photo lenses that use an electronic control aperture.*

The AtomOS10 monitoring mode allows the processing engine of the Ninja V to display the High Dynamic Range capabilities of a Log gamma input. HDR monitoring in AtomOS10 is the result of the research and development by Atomos that allows control of all aspects of the monitor through image processing to deliver the unclipped beauty of specular highlights through natural, vibrant colors with a result that allows you to simply shoot what you see. When the scene in front of you and the picture displayed on the Ninja look similar, your exposure should be correct but use in conjunction with the waveform monitor to verify.

One of the key elements to understand is that if your camera can shoot in Log then is can already capture the more dynamic range than you can display in SDR. Log preserves the highlight information by applying a Logarithmic curve to compress the additional stops of dynamic range to fit in to the Rec.709 standard. The image appears washed out and desaturated as each pixel contains more brightness information than SDR can display, if it were to do this it would be brighter than 100% Rec709 and so be clipped. This is illustrated below:

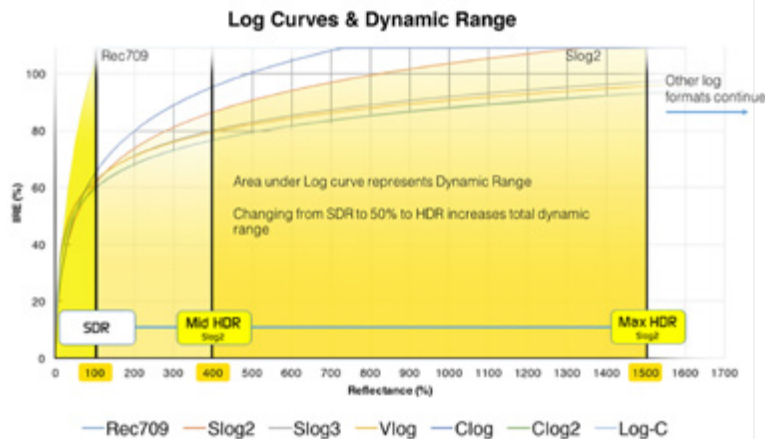

In addition to the SDR/HDR adjustments you have the following options:



Display off function allows for the screen to be turned off without affecting the operation of the unit. This is combined with the screen lock function and will become active by tapping the power on/off button on the side of the unit.



The Tally light on the rear of the unit will still display red for record and the idle (green) status will be displayed on the front screen LED.

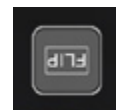

The Flip screen option allows you to invert the screen to meet your needs of operation.

 *Whilst the screen is inverted take note to respect the air flow and not to obstruct the cooling vents of the unit.*

8. Monitoring & Recording

Display

With this mode selected you have the option to change the screen brightness by adjusting the slider when in Native mode. As you slide to the right the brightness will increase and when at 100% the image will be using the full 1000nits of the display. As with any electronic screen device increasing the brightness will increase the power draw and battery life will be effected accordingly.

Adjustments can also be made to the Lift, Gamma and Gain of the display. You can tap the icon on the left of the menu to scroll through the options and adjustments are again made by moving the slider left and right.



Backlight:

Adjust the strength of the backlight. Disabled during HDR monitoring

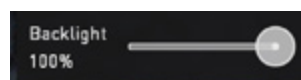

Lift:

Increasing lift will brighten the image and lessen the shadows



Gamma:

Gamma control allows you to create darker and richer shadows. This may be useful when monitoring in bright daylight conditions.



Gain:

Gain will boost the image brightness and affect the highlights



Reset:

Quickly return all values to default



File Recovery

The Ninja V continuously writes to disk while in recording mode. If the power fails or the drive is removed accidentally all but the last few seconds of the clip can be recovered

In the event of an interrupted recording, when you restart the Ninja V, or enter playback mode, you will be presented with a menu that gives you the option to recover immediately, or recover it later.

If you select recover later, every time you put the disk in, or start up the Ninja V, the same menu will appear to prompt you to recover the file that did not close properly.

⚠ If the drive is broken, or has become corrupted, then we will not be able to recover the file and we recommend that you try third-party hard disk recovery software

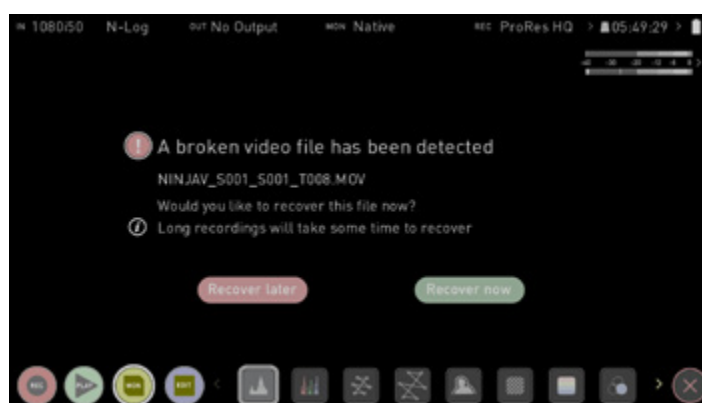

9. Playback & Playout

Playback mode

Pressing the Play button switches the device into playback mode and the last clip recorded on to the drive will instantly begin to playback.

Once within Play mode the complete Monitoring and Edit tool sets are available by tapping the buttons. Switch from Monitor to Edit tools by toggling the MON and EDIT buttons. Playback allows you to instantly analyse the content. This is key for establishing if takes are correctly focused, lighting has changed, or previewing recorded content with LUTs applied.

Clips/Playlist can be selected by tapping the folder icon in the lower right of the screen, or skip to the next or previous clip via the on screen controls.

Additional controls allow you to scrub through clips, set the playback speed and direction, as well as the ability to set the play mode to Loop. All these functions can also be used in 'Playout' mode, and you footage can be viewed on a larger screen or monitor for review and appraisal. You can even apply Log curves and LUTs to you clips as they are played back.

Playback Mode / Home



Main Controls

- REC (Record):**
Jump to Record Home Screen
- PLAY:**
Play and pause the current clip
- MON (Monitor):**
Reveal/hide monitoring tools. Toggle on/off
- EDIT:**
Reveal/hide Edit tools. Toggle on/off
- Settings:**
Touch to access Playback settings and tools.
- Recorded Files**
Browse recorded files

Scrub bar | Speed/direction control

Controls are available during playback. Scrub forward and back. Set playback direction and speed. The percentage slider allows for you to set the playback speed. This is perfect for previewing high frame rate at half or quarter speed such as 60p at 30p in either forward or reverse directions.

- 2x/4x**
Play back at 2 x or 4x speeds both forward and in reverse.
- Next/Previous**
Jump to next our previous take.
- Advance**
Whilst a clip is Paused these buttons have the ability to step the clip by 1 second either forward or reverse to give you chance to analyse the clip in more detail, this is especially useful when combined with the 2:1 zoom function.
- Loop**
By tapping this icon you can put the clip in to loop play back. In and out markers for loop you can be placed and cleared using the **edit tools**. See page 40.

9. Playback & Playout

Playback Mode

One of the key elements of the Ninja V is the ability to utilize the monitor recorder as a play back and play out device for the content that has been recorded whilst maintaining the same visually lossless high quality images. Ninja V's Play out capability also allows you to send the live and recorded footage out to a larger HDMI monitor or switcher.

Recorded Files

Browse recorded files

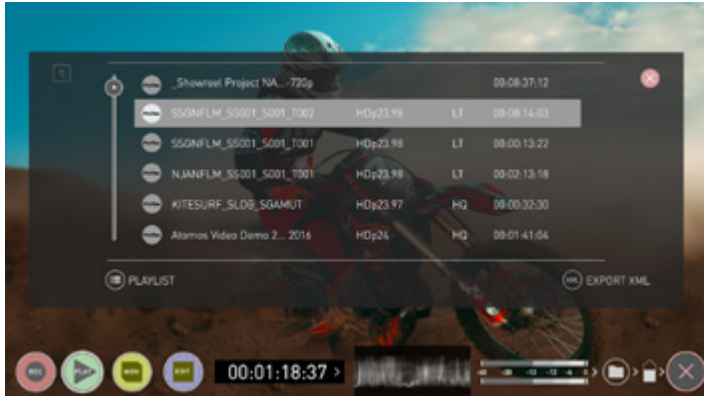

Pressing the filename or folder button will bring up a list of clips available on the drive. This will show clip name (with Scene shot Take numbers) as well as resolution, codec and duration Tap to highlight a clip, this will show a preview of the first frame in the back ground and tapping again or pressing play will play this clip.

When the playback content list menu is open play back will automatically stop.

To play the selected clip touch the file name again.

Playlists

To increase the functionality and flexibility of the playback mode there is also the ability to create a Playlist. To build a Playlist open the Recorded Files folder, then press the Playlist button which will turn green and reveal the options available.



It's important to note that all clips in the Playlist must be in the same codec, resolution and frame rate.

To return to normal playback of all recorded materials, press the Playlist icon again to deactivate the playlist



The **Order Arrow** allows you to choose order in which clips playback. The clips are stored based on the order they were recorded with the last clip recorded at the top of the list. You can either play down the list (newest to oldest) or up the list (sequential order).

Tags

Press to scroll through the Playlist options.

All will play all clips on the disk.

Favorites will play only the clips that are tagged as favorites.

Combined will play only the clips that are tagged with favorite and the selected clips

Selected will play only those clips selected

The duration of each clip is combined together and are shown on the scrub bar in play pack controls. A white vertical line indicates the start and end points and clips will seamlessly playback across those selected to be in the play lost.

Codec Playlist

You can select which clips are played back by toggling the available codecs.

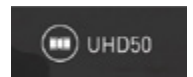

Favorite Playlist

The cut tag edit points can be combined with the favorites Playlist allowing the in and out points that have been created with in the clip using the favorites flag to be used as sub clips with in a Playlist. This means that if in and out points have been marked on a clip only those sections of the clip will play when used in a favorites or combined Playlist. Close attention should be paid to the order icon as this also relates to the sub clips in that with the run down order will play the last sub clip first in the Playlist.

Whilst a Playlist is in operation further metadata tags can not be applied to these clips.

More information about using the In and Out points, tagging and XML Export is available in the next section - Edit. See pages 40 for information on using marker points.

9. Playback & Playout



Video Format

Video Format

The Video Format menu contains information about the current settings of your Ninja V. The Format, compression rates and time remaining on your disk are displayed.

CAMERA OUTPUT

Indicates the total recording time remaining on your HDD/SSD media at the current settings. Changing your recording settings extend or decrease your available recording times.

Playback Auto HDR

Engage this switch if you are feeding HDR images to the Ninja V from a camera or games console that supports HLG or PQ HDR output directly, using the appropriate metadata flags. If you are feeding Log video to the unit be sure that this setting is off.

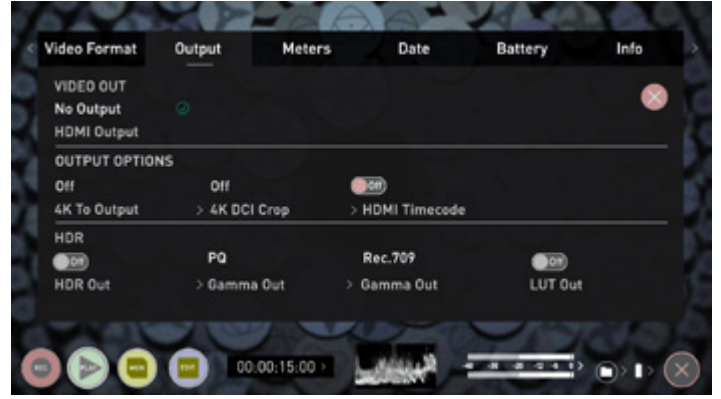

Output

Output

For information about this menu see page 20

Meters

Meters

For information about this menu see page 21

Date

Date

For information about this menu see page 23

Battery

Battery

For information about this menu see page 24



Info

Info

Shows the software (firmware) version and unique device ID (DID) of your Ninja V device. This will be required to activate the Avid DNxHD / Avid DNxHR codec. You can also check on the Atomos website to ensure you are running the latest firmware: www.atomos.com/support

10. Edit

Edit mode

Edit mode allows you to tag your clips during recording and playback, as well as the ability to add in and out-points to recorded clips.

By the pressing the Favorite and Reject icons you can assign a “good clip” or “bad clip”. This information can then be imported into a non-linear editing system to speed up the edit process. You can easily see which parts of your recording you have marked to keep or reject.

Favorite clips can easily be built into a Playlist in playback mode and these tagged sub clips can then be played out, back to back.





AtomOS10 has introduced extended tags to allow you to apply more specific tags that can help facilitate the edit.

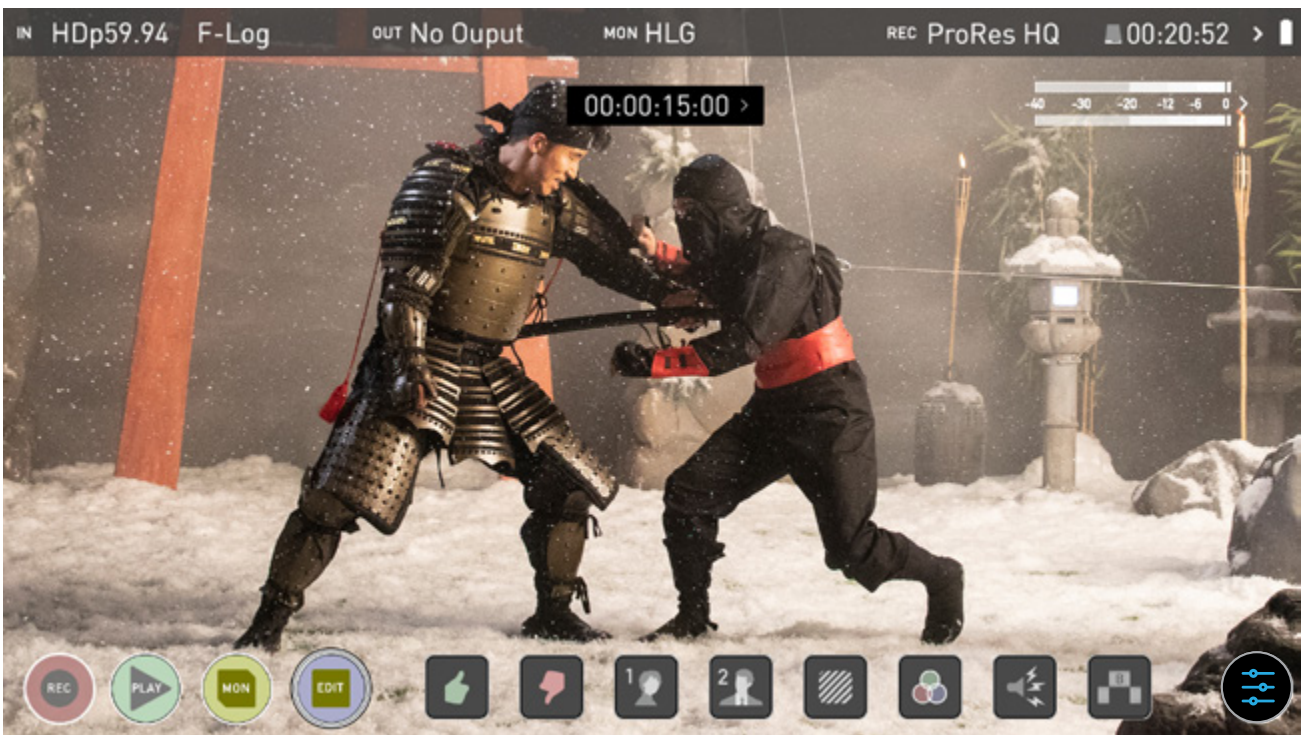













 SmartLog is compatible with FCPX XML (.fcpxml).

Playback Mode / Edit tools



Main Controls

-  **REC (Record):**
Press record to start recording
-  **PLAY:**
Play and pause the current clip
-  **MON (Monitor):**
Reveal/hide monitoring tools. Toggle on/off
-  **EDIT:**
Reveal/hide Edit tools. Toggle on/off
-  **SETTINGS:**
There are no user accessible settings available for Edit functions in AtomOS 10.01. This may change with future firmware updates.

 IN In-point	 OUT Out-point	 Favorite	 Reject
 1 Talent 1	 2 Talent 2	 Overexposed	 Color
 Noise	 Cut Away	 Close up	 Wide Shot
 XML EXPORT Export	 RESET Reset		

10. Edit

Markers and Tagging Icons (SmartLog)

Using Markers and Tags you can quickly start the editing and review process right here on your Ninja V, avoiding delays incurred when importing inferior and unwanted footage. You can review and tag immediately on-set with your client or director, or work through your takes without having to dump the recorded files to another workstation/NLE.



In-Point

Set the in-point by touching the button at desired point. Simply touch on to indicate in-point. Press a second time to reset in-point



Out-Point

Out-point can be set by simply tapping at desired out-point. To remove, tap again



Favorite

Mark the entire take as a favorite, or you can mark the parts of the take you wish to use. Apply multiple markers within one take if required



Reject

Mark the take/section as a reject



Talent 1

Tag talent or assign another meaning



Talent 2

Tag talent or assign another meaning, event etc.



Over Exposed

Tag clip as over exposed or out of focus



Color Correction

Tag clip as 'color'. Use tag to indicate a problematic image or even use for another purpose



Noise

Tag clip as containing background noise or interference

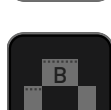

Cut Away

Tag clip as a cut away scene



Close Up

Tag clip as close up for use in edit and post



Wide Shot

Tag clip as wide shot



EXPORT XML

Once your clips have been tagged you can capture all the information and utilize the XML data to speed your edit and post production time.

 SmartLog is compatible with FCPX XML (.fcpxml).



RESET

Pressing the reset button will remove all tags and XML data from a clip. This can be useful when dealing with multiple takes or if a clip is tagged incorrectly. Reset will not remove or change in-point and out-point settings. To remove markers you will need to reset the in and out-points

Using Edit tools during recording, playback and monitoring

To access edit tools simply tap the Edit icon during record or monitoring.



In and Out points

Set in and out points easily during playback. Use the scrub control to accurately find the correct moment while the footage is paused.



Once markers are set, the footage will be clipped and only the enclosed footage will play. Reset markers to resume normal playback.

10. Edit



Favorite/Reject

Press Play and when you see the section of the footage you would like to mark as good or bad, press Favorite or Reject and then press again to stop marking that section. Multiple tags can be applied to your clips to provide Timecode accurate meta tags that can be exported to Apple FCPX XML.



 A green or red line will appear in the timeline scrubbing bar so you can identify the region that has been selected.



Using Extended Tags

Aside from Favorite and Reject tagging options, AtomOS10 includes extended tags that will greatly assist your edit and workflow processes. Careful consideration and use of tags during monitoring and review can be highly beneficial when you are ready to begin post production.



The tags will be available upon import of the XML file and can be used to filter and display different parts of your recordings, depending on how you have used the tags to mark and edit the footage. More information about using tags and XML import can be found on pages 45.



Tags are also useful during playback and allow you to create Playlists featuring only selected recordings from your disk. More information about Playlists can be found on page 37. A full list extended tagging options appears on page 38.



Your final stage is to Export the tags to a FCPX XML file:

- Press the EXPORT button



 SmartLog is compatible with FCPX XML (.fcpxml).

- You will be shown a please wait screen (the length of time will vary depending on your recording time and amount of flags applied)
- Then it will return you to the previous screen.

A XML file has been created on you SSD/HDD and can be instantly accessed by FCPX when the disc is connected to a computer using a compatible dock. See page 43 for more info.



RESET

Pressing the reset button will removed all tags and XML data from a clip. This can be useful when dealing with multiple takes or if a clip is tagged incorrectly. Reset will not remove or affect in-point and out-point settings. To removed markers you will need to reset the in and out-points

11 . HD Pulldown



What is Pulldown?

Many professional and consumer cameras available today do not send true 1080p24, 1080p23.98, 1080p25, 1080p29.97 or 1080p30 signals down their HDMI outputs.

Instead they send 1080i59.94 in NTSC regions (eg USA, Japan), and 1080i50 in PAL regions (eg Europe)

In order to convert the signal from the internal recording format to 1080i5994 or 1080i50, they use a process called 3:2 or 2:2 pulldown.

 Pulldown is only applicable to interlaced HD signals, not 4K

Camera Setting	Pulldown	Ninja V Receives
1080p23.98	3:2	1080i59.94
1080p24	3:2	1080i60
1080p25	2:2	1080i50
1080p29.97	2:2	1080i59.94
1080p30	2:2	1080i60

You will of course want the Ninja V to record the actual frame rate such as 1080p23.98, not the 1080i59.94 to disk. In many cases, it is not possible for the Ninja V to detect when pulldown has been applied to the video, so you will have to set the correct mode of removal on the Ninja V to match the setup of your camera.

With some cameras, the Ninja V can detect and remove the pulldown automatically, in which case the mode you expect (eg 1080p23.98) will display on the Ninja V and you will not have to do anything further.

If there is no input detected, then toggle the input by pressing the screen until you see the input you wish to record.

 Atomos is adding auto-detection support for more cameras, please check for firmware updates regularly at www.atomos.com

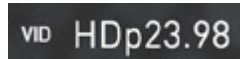



1080p23.98 or 1080p24

If you have set 1080p23.98 or 1080p24 in your camera and your Ninja V displays 1080i59.94 or 1080i60, then you can easily remove the pulldown by following these steps:

- Select the Input Menu from the top Left and toggle the blue arrow underneath Record repeatedly until you see 1080p23.98 (or 1080p24) displayed. You may not get a green tick in this column immediately.
- Your Ninja V needs to analyse the video for about 1 second, in order to detect the pulldown sequence and remove it.
- If it is not automatically detected after 1 second, wave your hand from side to side in front of the lens, or wave the camera from side to side for a few seconds. The Ninja V will detect the pulldown cadence in the movement, and you will see a green tick along with the video displayed on the screen.

 3:2 pulldown detection is difficult, if not impossible to detect on completely still video. This is why you should wave your hand in front of the lens.

 If you lose the input detection – for example you unplug the HDMI cable or go to Playback mode, you will need to wave your hand or the camera again, when the signal is restored to the Ninja V.

 Some cameras use a variant of pulldown removal, for example Panasonic Advanced pulldown. The Ninja V does NOT support this format, and it will not be detected.

 Standard Panasonic pulldown is supported, ensure in the Panasonic camera settings that pulldown is not set to Advanced.

1080p25, 1080p29.97 or 1080p30

For these modes, access the Record Menu tab and simply press the Record Format options repeatedly until your 1080p desired format is displayed. There is no need to wave your hand or the camera, as 2:2 pulldown removal does not require moving video.

12. Connecting & Editing

Connect

To access and edit your recorded material, connect the Master Caddy Docking Station to a Mac® or Windows® editing workstation via USB 2.0, USB 3.0 or USB-C 3.1.

Eject the Master Caddy or SSD mini from your Ninja V and insert it into the Docking Station. After a short wait, the recorded video will be accessible to the target computer via a standard disk (exFAT) file system.

NLE supported

We have chosen the Apple ProRes®, Avid DNxHD® and Avid DNxHR+ codecs as they are both not only visually lossless, but also edit-ready formats. All major NLEs support ProRes and DNxHD/DNxHR.

- Final Cut Pro (version 7)
- Final Cut X
- Davinci Resolve 8.0 +
- Adobe CS5 (with 5.51 update or later)
- EDIUS 6
- Vegas 10
- Lightworks
- Avid Media Composer 6 (version 8.3 or later for DNxHR)
- Autodesk Smoke

Avid DNxHD / DNxHR support requires online activation.

ExFAT compatibility

The Ninja V formats your disk as exFAT. We have chosen this file system to overcome the 4GB file limitation of FAT32 and keep compatibility on both Windows and MAC OS.

The Operating Systems that support exFAT are:

- Windows 10
- Snow Leopard 10.6.5 or higher
- Lion 10.7
- Mountain Lion 10.8
- Mavericks 10.9 and above

 The Master Caddy Docking Station is a sophisticated device supporting two different data interfaces: USB 2 and USB 3. When using the Master Caddy Docking Station you may need to connect both USB connectors. This is because when it has to power a disk drive and its interface electronics, the Docking Station may consume more power than is available from a single USB port.

Transferring files

Now your docking station is connected and your disk is recognized by your operating system, you can edit directly from the drive or copy the files to your own storage.

Windows

Open the disk in My Computer > Select all the files or just the ones you wish to transfer, copy and paste them to your desired location. (ctrl+c copy, ctrl+v paste).

Mac OS

Your Ninja V disk will show in Finder. Select the files you wish to transfer, drag the files to your desired location or use the copy and paste commands. (COMMAND + C copy, COMMAND + V paste).



* When using the AtomX USB-C 3.1 Docking Station II with older computers a USB 3.0 Male to Type C Female adaptor is required.

12. Connecting & Editing

Importing

Final Cut Pro (version 7), Final Cut Pro X, Adobe CS5 (with 5.51 update), EDIUS 6, Sony Vegas 10, Davinci Resolve 8.0 +, Lightworks and Avid Media Composer 6 support imported files from your Ninja V disk.

Importing Ninja V footage into Final Cut Pro X

You can import Ninja V footage into Final Cut Pro X (FCPX) in just a few simple steps.

First, connect the Ninja V Docking Station to your Apple Mac using the USB 2.0 or USB 3.0 port. Insert the Ninja V Master Caddy II containing the disk with your footage into the Docking Station and you will see the drive appear in your Finder window.

Start FCPX and open your project (or start a new one).

The screen will look like this:

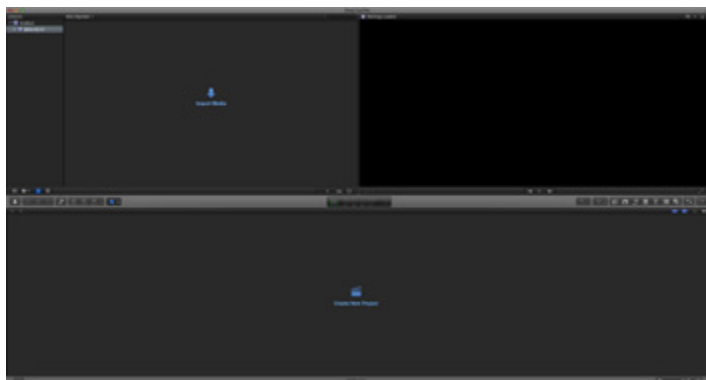

Go to the File menu and select Import > Media

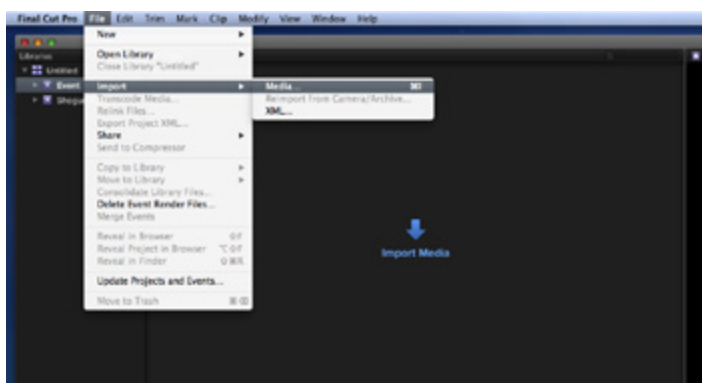

FCPX will show you a "browse" window. Look for the Ninja V drive, and click on it.

You'll see the folders in the Ninja V drive. Select the folder containing the footage you want to import:

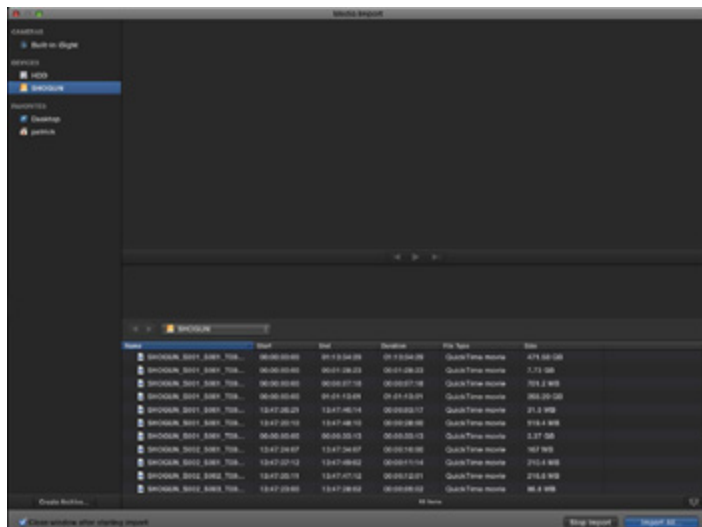

Click on Import All or Import Selected, individual clips can be selected. Choose the Event you wish to import the footage into, or create a new event.

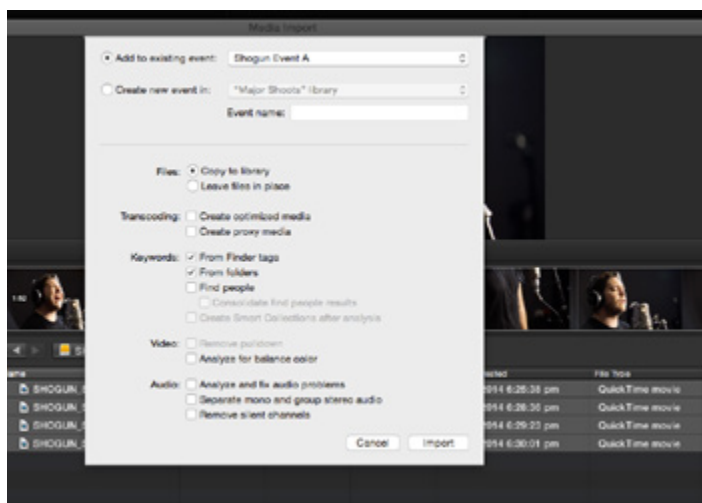

Select Import:



Your Scene, Shot and Take files now appear in the project window, ready for use in your FCP X project.

12. Connecting & Editing

SmartLog with FCP X

Prior to importing the XML files into FCP X, ensure that:

- You have exported XML whilst the drive is in your Ninja V
- You have connected your Master Caddy Docking Station and inserted your Master Caddy into the Dock
- You are using an operating system that supports ExFAT
- Your QuickTime version is up to date
- FCP X is the latest version

There are 2 ways to import the XML file:

1. Directly from the docked hard drive
2. Manually into FCP X

1. Automatic Import

- Open Finder
- Select the drive (in this example it is EXCVIDEO)
- Double-click the unitname.FCPXML file
- This will open FCP X and import the .xml file

FCP X will make an event of the disk, name and reference all the footage in that event.

You will notice that on the clips you have added Smart Tags too, with Green and Red indicating Favorite and Reject.

You can sort these by using the pull-down menu to show favorites. This will show all the individual favorites as separate clips in the Event Viewer.

2. Manual

- Open FCP X
- Create a New Project (or you can use an existing project); in this example it is called XML Import
- Select File, Import, XML

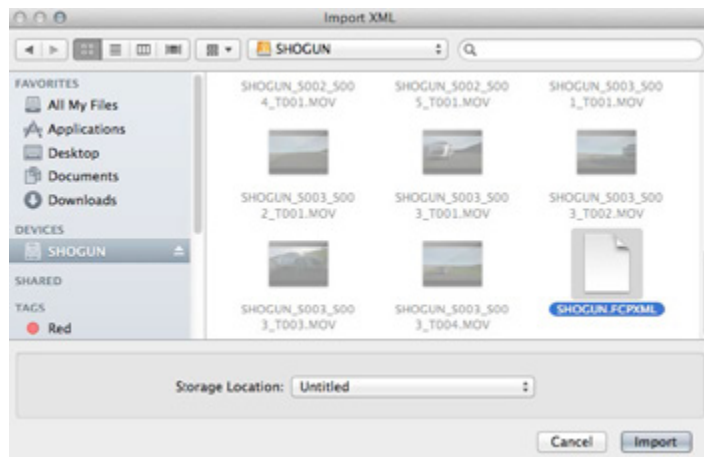

- Select the Ninja V drive under Devices (in this example it is called EXCVIDEO)
- Choose the unitname.FCPXML, select Import

The XML will import

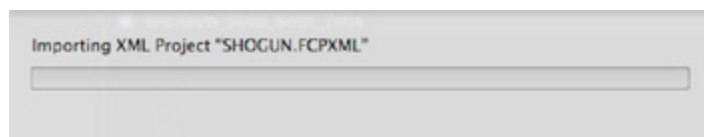

Once imported you can expand the clip and you will see the Favorite, Reject and other various tags. You can also filter the view to only see specific tags eg. favorite, etc.

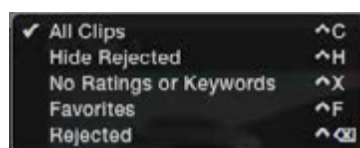

13. Technical Specifications

Weight and Dimensions	
Without batteries & media	360g / 12.7oz
With batteries & media	-
Dimensions (W x H x D mm)	151 x 91.5 x 31.5mm
Construction	Aluminium alloy chassis with ABS Polycarbonate back plate
Mounting points	Anti-rotational 3/8"-16 screw mount points, 1/4"-20 screw mount adaptor installed. 1x top and 1x bottom.
Power	
Operating power	10-22W
Compatible batteries	Atomos NP-F series and supporting accessories
Input voltage (battery)	6.2V to 16.8V
Battery time (based on 7.4V)	5200mAh - up to 2hrs (monitor & record 4K 60p) 7800mAh - up to 3hrs (monitor & record 4K 60p)
DC In	-
Continuous power * Patent pending	Continuous power with external adaptor*
Touchscreen	
Size	5.2"
Resolution / PPI	1920 x 1080 / 423ppi
Aspect ratio	16:9 native
Color Gamut	REC709 HDTV
Look up table (LUT) support	3D LUT (.cube format)
Anamorphic de-squeeze	2x, 1.5x, 1.33x, Panasonic 4:3 *Support for 2 x 4:3 4k 50/60p in future firmware update
Technology	SuperAtom IPS panel (capacitive touch), calibration to Rec.709 with optional calibration unit
AtomHDR	Yes
HDR Monitoring/Recording (Gamma)	Sony SLog / SLog2 / SLog3 Canon CLog / CLog2 / Clog3 ARRI Log CEI160 / LogCEI200 / LogCEI250 / LogCEI320 / LogCEI400 / LogCEI500 / LogCEI640 / LogCEI800 / LogCEI1000 / LogCEI1280 / LogCEI1600 Panasonic Vlog JVC JLog1 RED Log3G10 / RED LogFilm FujiFilm F-log Nikon N-Log PQ10k HLG
HDR Monitoring/Recording (Gamut)	Sony SGamut / SGamut3 / SGamut3.cine Canon Cinema / DCI P3 / DCI P3+ Nikon BT2020 Panasonic V Gamut Arri Alexa Wide Gamut Rec709 / BT.2020 JVC RED WideGamut / RED DragonColor / DragonColor2 / RED Color2 / RED Color3 / RED Color4 /
Bit depth	10-bit (8+2 FRC)
Brightness	1000nit (+/- 10%)
HDR input (PQ/HLG)	Yes
HDR output (PQ/HLG)	Yes
Video Input	
HDMI	1 x HDMI (2.0)
SDI	-
Signal	Uncompressed true 10-bit or 8-bit 422 (camera dependent)
Video Output (Play Out)	
HDMI	1 x HDMI (2.0)
SDI	-
Signal	Uncompressed true 10-bit or 8-bit 422 (playback file dependent)
Supported Loop Out Formats	
HDMI to HDMI	720p 50/60, 1080i 50/60, 1080p 24/25/30/50/60/100/120, 4kUHD/4kDCI 24/25/30/50/60
SDI to SDI	-
Gamma/Gamut conversion	Convert loop out to PQ/HLG and BT.2020/DCI-P3/Rec709

Video Signal Conversion		
HDMI (4K > HD)	Record/Loop out	
Codec		
Video to ProRes / DNxHR (DNx utilizes a .MOV wrapper)	Brand / Model / Codec Apple ProRes HQ, 422, LT AVID DNxHR HQX, HQ, SQ, LB	Resolution / Frame rate 4K DCI; 24/25/30/50/60p 4K UHD; 24/25/30/50/60p 2K 1080p; 24/25/30/50/60/100*/120* 1080i; 50/60i, 720p; 50/60p
Onboard Processing		
Pulldown removal	24/25/30pSF > 24/25/30p (2:2 pulldown) 60i > 24p (3:2 pulldown)	
4K UHD downscaling	Yes - Loop-out and playback	
Audio In/Out (48kHz PCM Audio)		
HDMI	2 or 8ch 24-bit, input device dependent	
SDI	-	
Audio	Line in / Mic in	
Headphone out	3.5mm Headphone out 2ch 48kHz 24-bit	
Built-in speakers	No	
Remote Start/Stop		
HDMI	Auto HDMI Trigger Supported Protocols - Canon, Sony Atomos Open Standard - Panasonic, Nikon, Olympus, Fuji, Leica	
SDI	-	
Other	LANC control - Slave	
Playback / Slow motion		
Playlist	Yes	
Genlock / LTC	Yes - with optional AtomX Sync	
CDNG (recorded content)	N/A	
ProRes (recorded content)	Yes	
DNxHR / DNxHD (recorded content)	Yes	
Recording		
Pre-roll record	Yes (HD 8s, 4K 2s)	
Custom timelapse	-	
Meta data tagging	Yes (10 tags available)	
Supported media	Support for AtomX SSDmini and MasterCaddy II with 2.5" SSD/HDD (Note: drive will extend beyond drive slot). Please visit atomos.com/drives for list of approved drives.	
Master caddy case	Master Caddy II (included) 75mm x 105mm x 12mm	
Master caddy dock	2.5" SATA to USB 2.0/3.0/USB-C 3.1 (not included)	
Supported applications	Supported Applications FCPX/FCP7+ / Media Composer 5.0+ Davinci Resolve 8+ / Premiere 5.5 / EDIUS 6.0+ Vegas Pro 10+ / Lightworks / Autodesk Smoke 2015	
XML support	FCPX XML native, FCPX/Adobe limited supported with 3rd party conversion tools	
What's in the Box		
Included	Ninja V unit, Master Caddy II x 1, 12V-3AAC power supply, 1x Battery Eliminator	
Optional extras	Power Kit: 2 x batteries, 1 x charger, 1 x power supply AtomX Sunhood for Ninja V AtomX Screen Protector for Ninja V AtomX SSDmini Handle Other: Atomos HDMI cables USB-C 3.1 Docking Station / USB 2.0 Docking Station Xrite i1 Display Pro Callibrator and USB to Serial cable	
Warranty	1 year. Extended to 3 years on product registration	

Construction note: Your Ninja V is designed to operate in ambient temperatures up to 40°C/104°F. If you wish to extend the temperature of operation in high temperature conditions, you can choose an SSD drive, and set the TFT brightness to a minimum.

Please note: Specifications are subject to change without notice. All information assumed correct at time of publishing.

14. Optional Accessories

Atomos has a wide range of optional accessories to enhance your Ninja V, from basic media requirements through to Sunhoods and mounting arms.

AtomX SSDmini by Sony



Designed specifically to fit the Ninja V the drive is just 8cm long, 7.5cm wide and weighs a mere 88g.

- 500GB
- 1TB
- 2TB

ATOMX

AtomX Arm & QR plate by Lanparte



- 10" and 13" models

Designed to provide a robust and easy solution for mounting your Ninja V to your camera, cage or rig. Articulating arm features friction resistance technology that keeps the tension applied whilst make minor adjustments.

ATOMX

AtomX SSDmini by Angelbird



Angelbird's AtomX SSDmini is custom made for the new Atomos Ninja V and is perfectly compatible with all the other available recorders.

- 500GB
- 1TB

ATOMX

Atomos AtomFlex Cables



Atomos makes a range of HDMI cables design to handle high data rates including 4K. Available in a various lengths and configurations to suit a range of applications

- 30cm
- 40cm
- Full → Micro / Mini / Full

AtomX Ninja V Sunhood ATOMSUN007



The Sunhood frame simply clips in to the top and bottom mounting holes to provide a sturdy base allowing the Sunhood to simply slide in for ease of use and fold flat when not in use. The clip on frame can remain in place without the Sunhood in place.

ATOMX

AtomX USB-C 3.1 Dock ATOMDCK004



Team up the USB-C 3.1 Docking station with your AtomX SSDmini or the SSD in your Atomos MasterCaddyII for reduced file transfer times. Max out the transfer speed of your SSD to create more time to focus on your craft and creativity.

ATOMX

AtomX Screen Protector (Ninja V) ATOMLCD03



An added layer of protection for the screen on the Ninja V. With a matte finish, the screen protector helps to minimise reflections.

- Easy-on + easy-off
- Protect screen

ATOMX

8. Power Kit ATOMPWRKT1



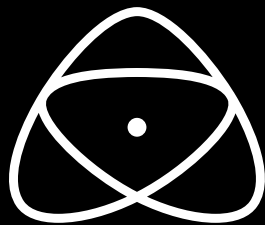

The Atomos Power Kit is ideally suited to the Ninja V. Suitable for use with all other Atomos Recorders.

- 1 x Fast charger
- 2 x 5200 mAh Battery



atomos.com

 /atomosglobal

 @atomos_news

 @Atomos_News

 /AtomosVideo

 /atomosvideo