



### Description

Crestron® in-wall dimmers and switches are modeled after the popular, modern look of Cameo® keypads. Available with adjustable button layouts and designer colors, the Cameo dimmers and switches are more versatile and affordable than previous generations. Like their cousin keypads, button caps can be swapped in the field, making it easy to change engraving or color. And their streamlined look inspires the combination of in-wall lighting control with centralized lighting control—delivering the ultimate, entire home control solution.

### Specifications

Specifications for the CLW-SWEX-P are listed in the following table.

*CLW-SWEX-P Specifications*

SPECIFICATION	DETAILS
Power Requirements	120 Vac, 60 Hz, line power
Load Types	CFL, Electronic Ballasts, Incandescent, Magnetic Low Voltage, Tungsten-Halogen
Load Ratings	
Minimum Load	25 W
Incandescent/Tungsten Halogen/Magnetic Ballasts	1000 VA/W
Electronic Ballasts/CFL	600 VA
Motor	1/2 HP
Environmental	
Temperature	32° to 104°F (0° to 40°C)
Humidity	10% to 90% RH (non-condensing)
Connections	
Hot	(1) 14-12 AWG, screw terminal, brass, line power input
Remote	(1) 14-12 AWG, screw terminal, blue, remote
Load	(1) 14-12 AWG, screw terminal, red, load output
Neutral	(1) 14-12 AWG, screw terminal, silver, neutral*
Ground	(1) 18 AWG Class 1 flying lead, green, ground (wire nut included)
Maximum Number of Remote CLW-SLVU-P Units	9

\* A neutral wire is required for normal operation.

### Important Notes (Read Before Installation)

**CAUTION:** TO REDUCE THE RISK OF OVERHEATING AND POSSIBLE DAMAGE TO OTHER EQUIPMENT, DO NOT INSTALL TO CONTROL A RECEPTACLE OR A TRANSFORMER-SUPPLIED APPLIANCE.

**ATTENTION:** GRADATEURS COMMANDANT UN BALLAST-AFIN DE RÉDUIRE LE RISQUE DE SURCHAUFFE ET LA POSSIBILITÉ D'ENDOMMAGEMENT À D'AUTRES MATÉRIELS, NE PAS INSTALLER POUR COMMANDER UNE PRISE OU UN APPAREIL ALIMENTÉ PAR UN TRANSFORMATEUR.

- Neutral: The CLW-SWEX-P requires a neutral connection to operate.
- Codes: Install in accordance with all local and national electrical codes.
- Wiring: Use copper wire only that are rated for at least 75°C.
- Lamp Type: For use with permanently installed incandescent, magnetic low voltage, tungsten-halogen, or CFL only.
- Temperature: For use where temperatures are between 32° to 104°F (0° to 40°C).
- Electrical Boxes: Devices mount in standard electrical boxes. For easy installation, use 3 1/2 in (89 mm) deep electrical boxes. Several devices can be installed in one electrical box (multigang). For a smooth appearance, one-piece multigang faceplates (not supplied) can be installed. When installing into a multigang box, do not fully tighten the devices to the box until the faceplate has been aligned.
- Switches: Mechanical 3- or 4-way switches do not work with the CLW-SWEX-P series switches.
- Spacing: If mounting one device above another, leave at least 4 1/2 in (115 mm) vertical space between them.
- Low Voltage Applications: Operation of a low voltage circuit with all lamps inoperative or removed may result in current flow in excess of normal levels. To avoid transformer overheating and premature transformer failure, Crestron recommends the following:
  - > Do not operate low voltage circuits without operative lamps in place.
  - > Replace burned-out lamps as quickly as possible.
  - > Use transformers that incorporate thermal protection or fuse transformer primary windings to prevent transformer failure due to overcurrent.

### Additional Resources

Visit the product page on the Crestron website ([www.crestron.com](http://www.crestron.com)) or scan the QR code to the right for additional information and the latest firmware updates.



### Installation

**WARNING:** To avoid fire, shock, or death, turn off power at circuit breaker or fuse and test that power is off before wiring!

**WARNING:** New installations should be checked for short circuits prior to installing a CLW-SWEX-P switch. With the power off, close the circuit and restore power. If the loads do not work or a breaker trips, check and correct the wiring or fixture (if necessary). Install the switch only when the short is no longer present. The warranty is void if the switch is installed and operated with a shorted load.

**NOTES:** Observe the following points.

- This product should be installed and used in accordance with appropriate electrical codes and regulations.
- This product should be installed by a qualified electrician.

**NOTE:** Before using the CLW-SWEX-P, ensure the device is using the latest firmware. Check for the latest firmware for the CLW-SWEX-P at [www.crestron.com/firmware](http://www.crestron.com/firmware). Firmware is loaded onto the device using Crestron Toolbox™.

1. Turn power off at the circuit breaker.
2. Wire the device as shown in the following diagrams.

*Wire the CLW-SWEX-P*

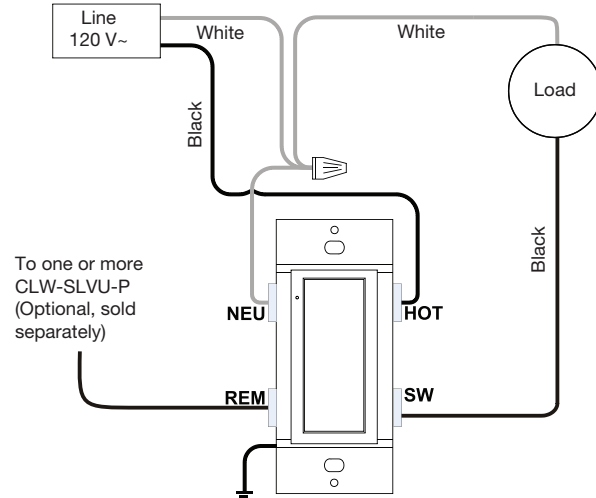

*Make Connections to the CLW-SWEX-P*

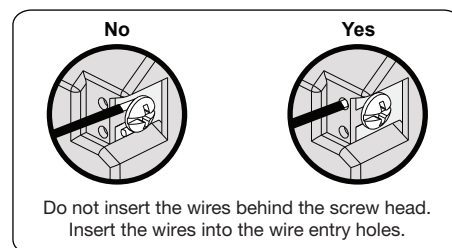

**NOTE:** Refer to the CLW-SLVU-P Installation Guide (Doc. 7364) for wiring details.

3. Push all power wires back into the electrical box and fasten the device to the electrical box with the provided screws.
4. Attach the decorative faceplate.
5. Ensure all buttons actuate without sticking.
6. Restore power at the circuit breaker.

### Changing Button Assemblies

The button assembly can be removed and replaced with other button assemblies. To change a button assembly, perform the following procedure.

1. Remove the button assembly by squeezing the sides of the bezel near the bezel snaps, as shown in the following diagram.

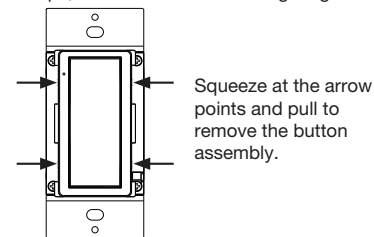

**NOTE:** When the button assembly is removed, power to the unit and load is removed automatically.

2. Remove the button(s) from the front of the button assembly.

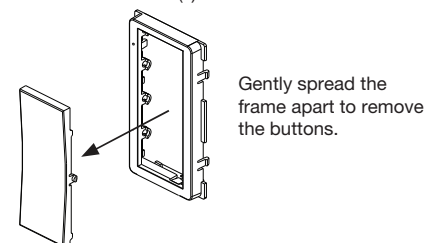

3. Insert the new buttons through the front of the bezel and snap them into place. Ensure that the LED is on the left side.

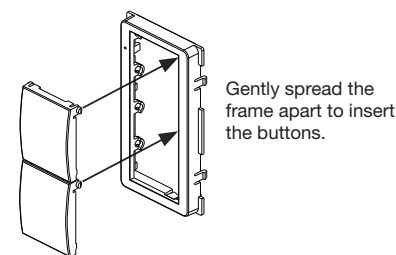

4. Attach the button assembly to the device. Ensure that the LED is on the left side.

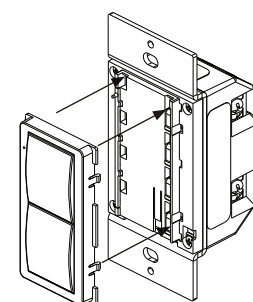

### Operation

**NOTE:** The device may be warm to the touch during operation. This is normal.

#### Basic Operation

Operation described in this guide assumes the CLW-SWEX-P is operating in Local mode (without the use of a control system). The CLW-SWEX-P can also operate in Remote mode in which button behavior is dictated entirely by the control system program. The CLW-SWEX-P is shipped with a rocker switch already installed. In this configuration, the unit will function as shown below.

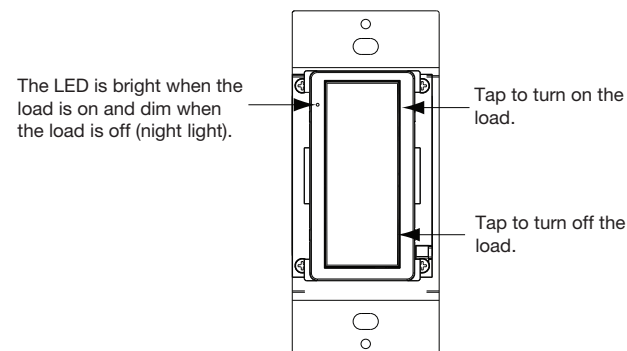

#### Default Button Functions

The figures below illustrate the default functions available for each physical button configuration and tap action sequence.

*Button Press*

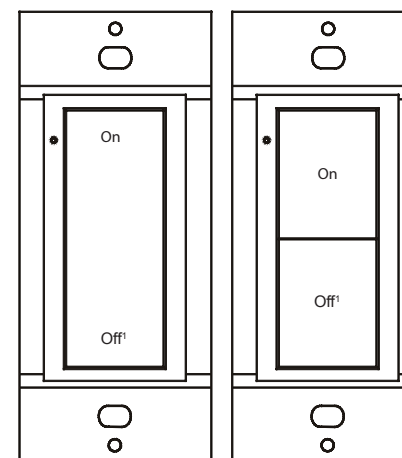

*Double Button Press (Press Twice within 1/2 Second)*

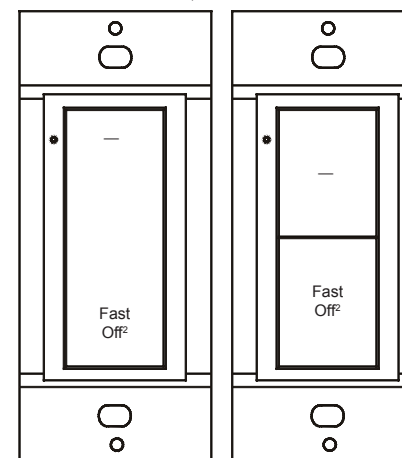

#### Master and Slave Operation

For more information on master and slave operation, refer to the CLW-SLVU-P Installation Guide (Doc. 7364).

1. Delayed off can be added via control system programming.
2. Fast off functionality is only performed if a delay has been added via control system programming.

## Wireless Communications

The device connects to the Crestron network via the infiNET EX® communications protocol. Use the procedures outlined below to join or leave an infiNET EX network and to verify communications between the device and the control system.

### Joining an infiNET EX Network

Before a device can be used in a lighting system, it must first join an infiNET EX network by being acquired by an infiNET EX gateway.

**NOTE:** A device can be acquired by only one gateway.

- Put the infiNET EX gateway into Acquire mode from the unit itself or from Crestron Toolbox™, as described in its manual at [www.crestron.com/manuals](http://www.crestron.com/manuals).

**NOTE:** In an environment where multiple gateways are installed, only one gateway should be in Acquire mode at any time.

- Place the device into Acquire mode.
  - Tap the top button three times, and then press and hold it down (tap-tap-tap-press+hold) until the top LEDs on the device flash once (this can take up to 10 seconds).
  - Release the button to start the acquire process. The top LED blinks slowly to show that the device is actively scanning the infiNET EX network.
    - The top two LEDs turn on for 5 seconds to show that the device has been successfully acquired to the infiNET EX network.
    - The top LED blinks fast to indicate that the device was not successfully acquired by the infiNET EX network. Tap the setup button to acknowledge failure to acquire the infiNET EX network. Ensure the gateway is in Acquire mode and within range before attempting the acquire process again.
- Once all devices have been acquired, take the gateway out of Acquire mode. Refer to the gateway's manual for details.

### Leaving an infiNET EX Network

To leave an infiNET EX network, put the device into Acquire mode, as described in "Joining an infiNET EX Network" above, when no gateway is in Acquire mode.

### Verifying Communications Status

To check the communications status of the device, tap the setup button three times and then press and hold it down (tap-tap-tap-press+hold) for up to 2 seconds. The LED blinks to indicate the communications status. Refer to the following table for details.

LED	COMMUNICATIONS STATUS
Turns on for 5 seconds	Device is communicating with the control system.
Blinks three times	Device is communicating with the gateway but the gateway is not communicating with the control system.
Blinks twice	Device was previously joined to the network but is not communicating with the gateway.
Blinks once	Device is not joined to the network.

## Troubleshooting

The following table provides corrective action for possible trouble situations. If further assistance is required, please contact a Crestron customer service representative.

*CLW-SWEX-P Troubleshooting*

TROUBLE	POSSIBLE CAUSES	CORRECTIVE ACTION
The switch does not function.	The switch is not receiving line power.	Verify that the switch is properly connected to the power line and that the circuit breaker is closed.
	The load is not operational (e.g., the lamps are burned out).	Verify that the load is operational.
	The device is in Remote mode.	Check the SIMPL program to determine or change the operating mode.
	The switch is not connected to a neutral.	Add a connection to a neutral.

This product is Listed to applicable UL Standards and requirements by Underwriters Laboratories Inc.



### Federal Communications Commission (FCC) Compliance Statement

This device complies with part 15 of the FCC Rules. Operation is subject to the following conditions: (1) This device may not cause harmful interference and (2) this device must accept any interference received, including interference that may cause undesired operation.

**CAUTION:** Changes or modifications not expressly approved by the manufacturer responsible for compliance could void the user's authority to operate the equipment.

**NOTE:** This equipment has been tested and found to comply with the limits for a Class B digital device, pursuant to part 15 of the FCC Rules. These limits are designed to provide reasonable protection against harmful interference in a residential installation. This equipment generates, uses and can radiate radio frequency energy and, if not installed and used in accordance with the instructions, may cause harmful interference to radio communications. However, there is no guarantee that interference will not occur in a particular installation. If this equipment does cause harmful interference to radio or television reception, which can be determined by turning the equipment off and on, the user is encouraged to try to correct the interference by one or more of the following measures:

- Reorient or relocate the receiving antenna
- Increase the separation between the equipment and receiver

- Connect the equipment into an outlet on a circuit different from that to which the receiver is connected
- Consult the dealer or an experienced radio/TV technician for help

### Industry Canada (I C) Compliance Statement

This device complies with Industry Canada licence-exempt RSS standard(s). Operation is subject to the following two conditions: (1) this device may not cause interference, and (2) this device must accept any interference, including interference that may cause undesired operation of the device.

Under Industry Canada regulations, this radio transmitter may only operate using an antenna of a type and maximum (or lesser) gain approved for the transmitter by Industry Canada. To reduce potential radio interference to other users, the antenna type and its gain should be so chosen that the equivalent isotropically radiated power (e.i.r.p.) is not more than that necessary for successful communication.

This radio transmitter, IC: 5683C-CWD6790, has been approved by Industry Canada to operate with the antenna types listed below with the maximum permissible gain and required antenna impedance for each antenna type indicated. Antenna types not included in this list, having a gain greater than the maximum gain indicated for that type, are strictly prohibited for use with this device.

- Antenna Type: Inverted-F, Maximum permissible antenna gain: 2.66 dBi, Impedance: 50 Ohms

### Industrie Canada (IC) Déclaration de conformité

Le présent appareil est conforme aux CNR d'Industrie Canada applicables aux appareils radio exempts de licence. L'exploitation est autorisée aux deux conditions suivantes : (1) l'appareil ne doit pas produire de brouillage, et (2) l'utilisateur de l'appareil doit accepter tout brouillage radioélectrique subi, même si le brouillage est susceptible d'en compromettre le fonctionnement.

Conformément à la réglementation d'Industrie Canada, le présent émetteur radio peut fonctionner avec une antenne d'un type et d'un gain maximal (ou inférieur) approuvé pour l'émetteur par Industrie Canada. Dans le but de réduire les risques de brouillage radioélectrique à l'intention des autres utilisateurs, il faut choisir le type d'antenne et son gain de sorte que la puissance isotrope rayonnée équivalente (p.i.r.e.) ne dépasse pas l'intensité nécessaire à l'établissement d'une communication satisfaisante.

Le présent émetteur radio , IC: 5683C-CWD6790, a été approuvé par Industrie Canada pour fonctionner avec les types d'antenne énumérés ci-dessous et ayant un gain admissible maximal et l'impédance requise pour chaque type d'antenne. Les types d'antenne non inclus dans cette liste, ou dont le gain est supérieur au gain maximal indiqué, sont strictement interdits pour l'exploitation de l'émetteur.

- Type d'antenne: Inversé-F, Gain admissible maximal: 2.66 dBi, Impédance: 50 Ohms

To satisfy RF exposure requirements, this device and its antenna must operate with a separation distance of at least 20 centimeters from all persons and must not be collocated or operating in conjunction with any other antenna or transmitter.

The product warranty can be found at [www.crestron.com/warranty](http://www.crestron.com/warranty).

The specific patents that cover Crestron products are listed at [patents.crestron.com](http://patents.crestron.com).

Crestron, the Crestron logo, Cameo, Crestron Toolbox, and infiNET EX are either trademarks or registered trademarks of Crestron Electronics, Inc. in the United States and/or other countries. UL and the UL logo are either trademarks or registered trademarks of Underwriters Laboratories, Inc. in the United States and/or other countries. Other trademarks, registered trademarks, and trade names may be used in this document to refer to either the entities claiming the marks and names or their products. Crestron disclaims any proprietary interest in the marks and names of others. Crestron is not responsible for errors in typography or photography.

This document was written by the Technical Publications department at Crestron.

©2015 Crestron Electronics, Inc.

### Crestron Electronics, Inc.

15 Volvo Drive Rockleigh, NJ 07647  
Tel: 888.CRESTRON  
Fax: 201.767.7576  
[www.crestron.com](http://www.crestron.com)

### Installation Guide - DOC. 6821D

(2024292)

03.15

Specifications subject to change without notice.