

FLX-MADI

MADI-to-everything

Digital Audio Converter

User's Manual

((en))

Table of Contents

1.	QUICK REFERENCE.....	4
2.	INTRODUCTION.....	5
2.1.	Purpose.....	5
2.2.	Box Contents.....	5
2.3.	Conventions used in this manual.....	5
3.	POSSIBLE SETUPS.....	6
3.1.	Available AUX cards.....	6
3.2.	Available FLX devices.....	7
3.3.	FlexLink connection.....	7
4.	AUDIO ROUTING.....	8
4.1.	Modes and indication.....	8
4.2.	Selecting the Route Mode.....	9
4.3.	Remarks.....	9
5.	CLOCK SETTINGS.....	10
5.1.	Clock sources and indication.....	10
5.2.	Selecting the Clock Source.....	10
6.	ACCESSING INTERNALS.....	12
6.1.	Opening the device.....	12
6.2.	Inside view.....	12
6.3.	Installing AUX cards.....	12
7.	DIP SETTINGS.....	13
7.1.	Base device config (DIP1..3).....	13
7.2.	AUX config (DIP4..6).....	14
7.3.	FlexLink channel mapping (DIP7..9).....	15
8.	SPECIAL OPERATING MODES.....	16
8.1.	Version Display.....	16
8.2.	LED Test.....	16
8.3.	Interface Self-Test.....	16
8.4.	Firmware update.....	17
9.	SPECIFICATIONS.....	18
10.	ACCESSORIES.....	18
10.1.	Rack mount kits.....	18
10.2.	Additional (redundant) power supply.....	18
11.	APPENDIX.....	19
11.1.	Warranty.....	19
11.2.	Manufacturer contact.....	19
11.3.	FCC Compliance.....	19
11.4.	Recycling.....	20

11.5. Document Revision History.....20
11.6. About this document.....20

1. QUICK REFERENCE

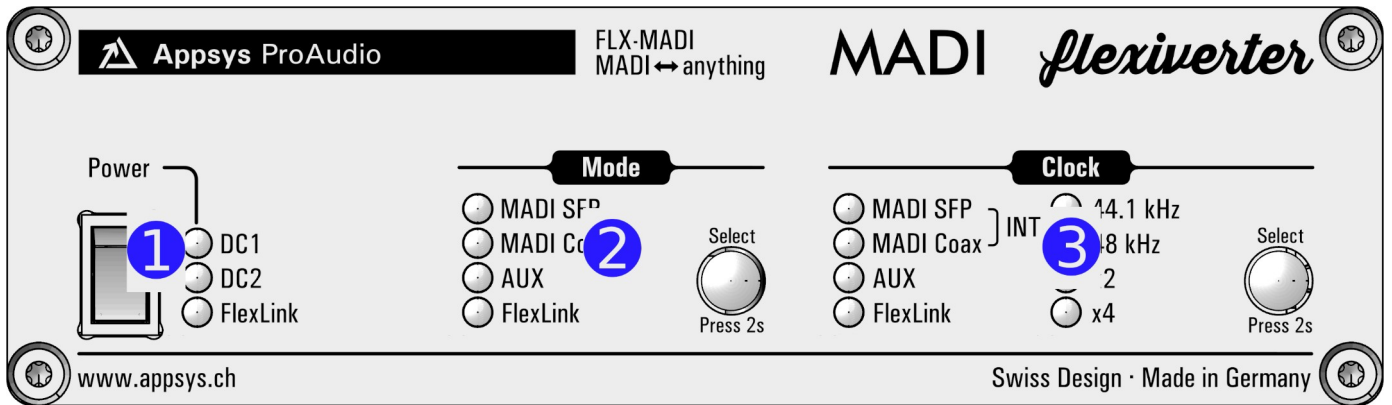

- 1 Power switch and "power good" indicators. LEDs light up blue when power is available on the respective port.
- 2 Mode indicators/selector. Long-press the "Select" button to change the audio routing between the interfaces. Wait four seconds to activate the selected mode.
- 3 Clock indicators/selector. Long-press the "Select" button to change the clock source and sample-rate. Wait four seconds to activate the selected mode.

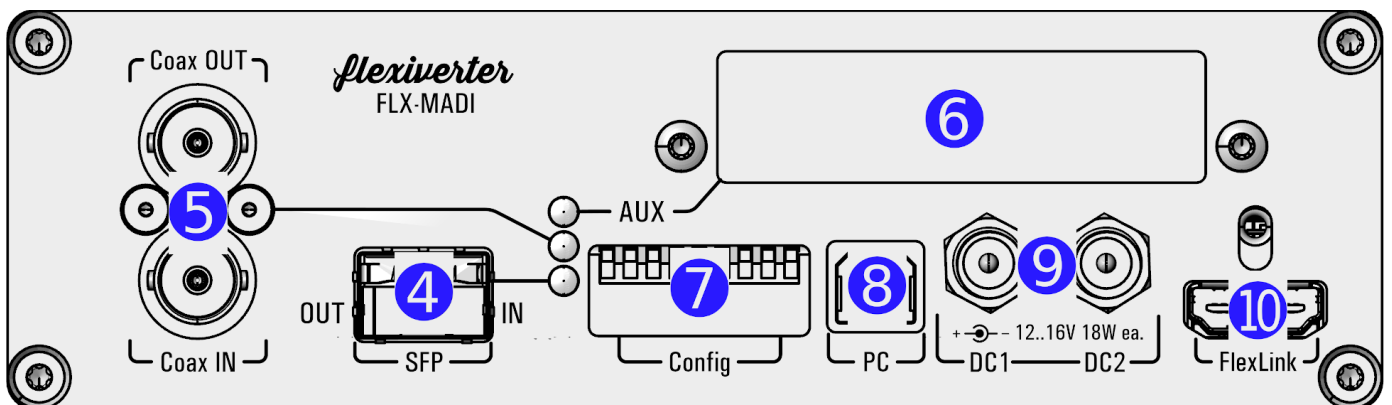

- 4 MADI SFP port. Pre-installed 1310nm Multimode SFP, accepts any other SFPs Compatible to standard MADI optical (SC plugs) using an LC-to-SC adapter cable
- 5 MADI Coaxial port
- 6 AUX slot. Accepts optional card for standalone use, or additional MADI channels
- 7 DIP switches, mostly to control output data format. See [7. DIP Settings](#)
- 8 USB port (firmware update only, no audio)
- 9 Redundant DC input ports
- 10 FlexLink: optional connection to second flexiverter, or to multiverter.

2. INTRODUCTION

2.1. Purpose

The FLX-MADI device is as digital audio converter, providing two built-in MADI interfaces and a third one (or many other interfaces) with optional AUX cards. It can be used in different setups, depending on the user's needs:





- standalone, to convert between the built-in MADI ports (media converter),
- standalone, to convert between one of the built-in MADI ports and an additional AUX card (MADI-to-anything),
- together with another flexiverter, connected via FlexLink (for up to 192x192 channels),
- together with the multiverter, connected via FlexLink. This provides remote control, channel-wise routing and SRC (Sample Rate Conversion).

For a detailed description of possible configurations see [3. Possible Setups](#).

2.2. Box Contents

- 1 FLX-MADI Converter
- 1 HDMI cable 0.5m / 1.7 ft with locking screws
- 1 Power supply
- 1 Power cord (country specific)
- This manual

2.3. Conventions used in this manual

- A button on the front is shown like this:  or 
- A LED is shown like this:  off /  on /  blinking





Filled circles with an exclamation mark indicates an action that must be performed ("Required").



A section marked with an "information" icon indicates a useful tip.

3. POSSIBLE SETUPS

The device can be used in three different setups, shown below:

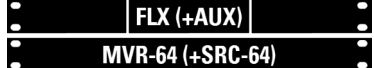
	SETUP		
	flexiverter + AUX card	Double-flexiverter	flexiverter + multiverter
			
How it works	Converts between built-in interface and the AUX card. For a list of AUX cards, see 3.1 Available AUX cards .	Devices are connected via FlexLink cable. Converts between one FLX(+AUX) and the other FLX(+AUX).	Flexiverter connected to multiverter via FlexLink cable. FLX(+AUX) serves as extension to the MVR-64
Channels (all can be used at the same time)	64x64 MADI @ 48kHz 32x32 MADI @ 96kHz 16x16 MADI @ 192kHz or maximum capacity of the AUX card, whichever is less	128x128 MADI @ 48kHz 64x64 MADI @ 96kHz 32x32 MADI @ 192kHz plus what the AUX card provides	448x448 from multiverter plus 128x128 MADI plus what the AUX card provides
Redundant power supply	up to 2x	up to 3x	up to 3x
Battery-powered operation (DC 12-15V)	yes	yes	yes
Sample Rate Conversion	no	no	yes (with SRC-64 card in Multiverter)
Signal splitting	yes (to AUX or FlexLink)	yes (to AUX or FlexLink)	yes, to everything
Channel-wise routing	no	no	yes, via MVR-64 (web, telnet or serial terminal)
Remote control	no	no	yes, via MVR-64 (web, telnet or serial terminal)
Rack mount	1U total	1U total	2U total

3.1. Available AUX cards

At the time of writing (2021-11), the following AUX cards are available. More will come, please check www.appsys.ch for updates.

Item	Description
AUX-ADAT	16x16ch ADAT I/O (2x Toslink In + 2x out). Supports also S/PDIF
AUX-AES3	8x8ch AES3 I/O on 1x DB25, fully transformer isolated
AUX-AES67	64x64ch AES67 network card

AUX-AVB ¹	16x16ch / 32x0ch / 0x32ch MILAN-approved AVB
AUX-DAC ¹	8ch analog outputs (1xDB25)
AUX-DANTE	64x64ch DANTE network card
AUX-MADI-COAX	64x64ch MADI for coaxial cable (BNC connectors)
AUX-MADI-OPTO	64x64ch MADI optical, SC connector (Multimode 125um 1310 nm)
AUX-MADI-SFP	64x64ch MADI for SFP (Small-Factor Pluggable) modules
AUX-WORDCLOCK	BNC wordclock I/O

3.2. Available FLX devices

At the time of writing (2021-11), the following FLX devices are available. More will come, please check www.appsys.ch for updates.

Item	Description
FLX-AES3	16x16 channel AES3 flexiverter (with AUX slot)
FLX-AES50	96x96 channel AES50 flexiverter (with AUX slot)
FLX-AES67	64x64 channel AES67 flexiverter (with AUX slot)
FLX-DANTE	64x64 channel DANTE flexiverter (with AUX slot)
FLX-MADI	128x128 channel MADI SFP & MADI coaxial module (with AUX slot)

3.3. FlexLink connection

The FlexLink connection is designed to connect Flexiverterter with each other, or with the Multiverter. It provides:

- 192x192 channels bi-directional transmission of 24-bit uncompressed audio (fully transparent to AES3 compatible metadata bits)
- Super-low link latency of 4 samples (ca. 83µs)
- Dedicated, high-quality reference clock signal with automatic configuration
- Power supply for connected devices (to reduce cabling), alternatively serves as redundancy scheme when both devices are powered: in case of power failure, both devices keep working from the remaining power supply.
- Uses standard HDMI cables (with locking screws), to provide easy field replacement in case of defects.

¹ Estimated availability: Q1/2022

4. AUDIO ROUTING

The flexiverter can operate in various routing modes, allowing you to pass audio between the available interfaces (MADI SFP, MADI coaxial, AUX and FlexLink) in many different ways. The LEDs in the "MODE" section indicate the involved interfaces.

4.1. Modes and indication

Mode (route between)	Operation (Example)	Setup (blinking alternately)	Remarks
MADI SFP + MADI Coaxial + (+AUX) < > FlexLink	<ul style="list-style-type: none"> ● MADI SFP ● MADI Coaxial ● AUX ● FlexLink 	<ul style="list-style-type: none"> ✱ ○ MADI SFP ✱ ○ MADI Coaxial ✱ ○ AUX ○ ✱ FlexLink 	AUX LED only active when card installed
MADI SFP < > MADI Coaxial	<ul style="list-style-type: none"> ● MADI SFP ● MADI Coaxial ○ AUX ○ FlexLink 	<ul style="list-style-type: none"> ✱ ○ MADI SFP ○ ✱ MADI Coaxial ○ ○ AUX ○ ○ FlexLink 	Additional split of MADI SFP to AUX. Additional split of everything to FlexLink ²
MADI SFP < > AUX	<ul style="list-style-type: none"> ● MADI SFP ○ MADI Coaxial ● AUX ○ FlexLink 	<ul style="list-style-type: none"> ✱ ○ MADI SFP ○ MADI Coaxial ○ ✱ AUX ○ ○ FlexLink 	Additional split of MADI SFP to MADI coaxial. Additional split of everything to FlexLink ²
MADI Coaxial < > AUX	<ul style="list-style-type: none"> ○ MADI SFP ● MADI Coaxial ● AUX ○ FlexLink 	<ul style="list-style-type: none"> ○ ○ MADI SFP ✱ MADI Coaxial ○ ✱ AUX ○ ○ FlexLink 	Additional split of MADI optical to MADI SFP. Additional split of everything to FlexLink ²

LED color	Meaning
○ off	Interface not active / involved
● green	IN and OUT valid
○ white	OUT valid, but no IN detected
● red	No valid signal or no valid clock. <ul style="list-style-type: none"> ◆ If the clock LEDs show red, make sure the clock mode is set correctly and a valid clock is supplied. ◆ If the clock LEDs show green, the clock is ok but the input is not detected. Check the respective connection.
✱ red blinking	Interface is currently booting and not yet active
✱ yellow blinking	Mode setting active: Alternately blinking LEDs indicate the interfaces between which data is converted; constant lit LEDs indicate splitting destinations. Press MODE button again to cycle through available modes. After 4



2 All incoming data is also split (output) to FlexLink: MADI SFP is split to Lane 1 (ch1-64), MADI coaxial is split to Lane 2 (ch65-128) and AUX is split to Lane 3 (ch129-192). The split is not indicated on the LEDs for clarity but is always active.

	seconds, the selected mode is applied automatically.
--	--

4.2. Selecting the Route Mode

- Long-press the button until the LEDs are blinking yellow.
- Current routing mode is shown by alternately yellow blinking LEDs, indicating the interfaces where the signal is passed between.
- Press the button repeatedly to cycle between available modes, until the desired mode is shown.
- After four seconds without interaction, selection mode is terminated and the current setting comes into effect.

4.3. Remarks

- Routing between the selected interfaces is always bi-directional, meaning that audio is passed between them both ways. A working bi-directional link shows  green for both interfaces. If the LED shows  white, the corresponding interface does only output data but no input on it has been detected. If the LED shows  red, the interface is not connected, or the clock is invalid or missing.
- Channel-wise routing and splitting (crosspoint switch/matrix) between all channels is possible when the flexiverter is connected to a multiverter. Routing is then done via the multiverter's web interface or via the command line.

5. CLOCK SETTINGS

5.1. Clock sources and indication

The flexiverter can be clocked from every interface (acting as clock slave), or can run on its internal clock (acting as clock master).

Clock source	"Clock" Indication (Example)	Remarks
MADI SFP	<input checked="" type="radio"/> MADI SFP <input type="radio"/> 44.1 kHz <input type="radio"/> MADI Coaxial <input checked="" type="radio"/> 48 kHz <input type="radio"/> AUX <input type="radio"/> x2 <input type="radio"/> FlexLink <input type="radio"/> x4	
MADI Coaxial	<input type="radio"/> MADI SFP <input type="radio"/> 44.1 kHz <input checked="" type="radio"/> MADI Coaxial <input checked="" type="radio"/> 48 kHz <input type="radio"/> AUX <input type="radio"/> x2 <input type="radio"/> FlexLink <input type="radio"/> x4	
Internal ("INT")	<input checked="" type="radio"/> MADI SFP <input type="radio"/> 44.1 kHz <input checked="" type="radio"/> MADI Coaxial / INT <input checked="" type="radio"/> 48 kHz <input type="radio"/> AUX <input type="radio"/> x2 <input type="radio"/> FlexLink <input type="radio"/> x4	Flexiverter acts as clock master.
AUX	<input type="radio"/> MADI SFP <input type="radio"/> 44.1 kHz <input type="radio"/> MADI Coaxial <input checked="" type="radio"/> 48 kHz <input checked="" type="radio"/> AUX <input type="radio"/> x2 <input type="radio"/> FlexLink <input type="radio"/> x4	Only available with AUX installed. AUX card acts as clock master. Use an AUX-WORDCLOCK if you need BNC wordclock I/O.
FlexLink	<input type="radio"/> MADI SFP <input type="radio"/> 44.1 kHz <input type="radio"/> MADI Coaxial <input checked="" type="radio"/> 48 kHz <input type="radio"/> AUX <input type="radio"/> x2 <input checked="" type="radio"/> FlexLink <input type="radio"/> x4	Clock is taken from the peer device (Flexiverter or Multiverter)

LED color	Meaning
<input type="radio"/> off	Interface not active / not involved
<input checked="" type="radio"/> green	Selected, locked and synced
<input checked="" type="radio"/> red	No valid clock. No input connected or no master clock signal detected
<input checked="" type="radio"/> yellow blinking	Clock setting active. Press CLOCK button to go to the next clock source. After 4 seconds, selection mode is terminated and the selected mode comes into effect.

5.2. Selecting the Clock Source

- Long-press the **Clock** button until the LEDs are blinking yellow.
- Current clock source/modes is shown by blinking LED(s).

- Press the **⊙ Clock** button repeatedly to cycle between the available clock sources. Depending on the source, you might need to select the desired sample rate (**⌘ 44.1 kHz** or **⌘ 48 kHz**) and/or the appropriate multipliers (**⌘ x2** / **⌘ x4**).
- After four seconds without interaction, clock setting is automatically terminated and the selected clock source comes into effect.



When the samplerate is incorrectly set (e.g. 48k with 96k data), unwanted effects (double samples, zero samples, channel crosstalk etc.) may occur and might not be noticed immediately. Always double-check that the samplerate is set correctly on all involved devices!

6. ACCESSING INTERNALS

6.1. Opening the device

- Required: Torx T10 screwdriver.
- Power off the device and detach all cables to avoid short-circuit or damage.
- Detach the device from the rack-mount kit.
- Remove the four top screws and the top cover by pulling it upwards:

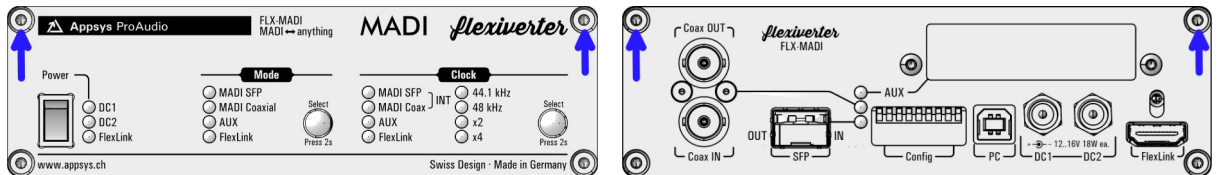

6.2. Inside view

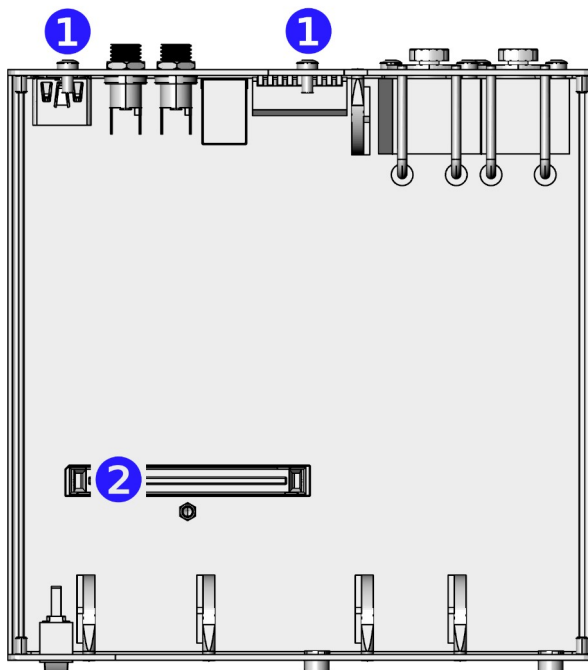

- ① Screws for AUX cover plate
- ② AUX card connector

6.3. Installing AUX cards

- Remove the screws holding the cover plate, and the blank cover plate ①
- Insert the AUX card from inside, using the supplied cover plate. Make sure it is correctly fitted to the card connector ②
- Secure the card using two cover screws ①
- The card has been installed correctly if you are able to select an audio routing mode involving AUX (long-press MODE button to enter Route Mode Selection).

7. DIP SETTINGS

Fine-tuning of the flexiverter's built-in interface behavior and of the AUX card can be achieved via DIP settings on the back side. Changing the DIP settings will come immediately into effect. **Default setting: all switches up.**

7.1. Base device config (DIP1..3)

The configuration below affects only the MADI *outputs*. The input format is automatically detected, independent of the DIP switch settings.

<input type="checkbox"/> 96k frame* ³	<input type="checkbox"/> <input type="checkbox"/> 64ch output* ³
<input checked="" type="checkbox"/> 48k frame ³	<input type="checkbox"/> <input type="checkbox"/> 57ch (use for DiGiCo stagebox control) ³
	<input type="checkbox"/> <input type="checkbox"/> 56ch output ³
	<input type="checkbox"/> <input type="checkbox"/> reserved

* Default setting

7.2. AUX config (DIP4..6)

Many AUX card provide additional settings, which can be adjusted using these switches. The actual meaning depends on the type of AUX card installed:

AUX-ADAT	<input type="checkbox"/> Channels 1-8: 4 ADAT format* ³	<input type="checkbox"/> Channels 9-16: 5 ADAT format* ³	<input type="checkbox"/> AES3 (Professional) ³ 6 only for non-ADAT
	<input type="checkbox"/> Channels 1-2: 4 AES3/SPDIF format ³	<input type="checkbox"/> Channels 9-10: 5 AES3/SPDIF format ³	<input type="checkbox"/> SPDIF (Consumer) ³ 6 only for non-ADAT

AUX-AES3	<input type="checkbox"/> <input type="checkbox"/> Single Wire (full channel count at 48k, 96k and 192k), 4 5 professional format for metadata*
	<input type="checkbox"/> <input type="checkbox"/> Double wire (half channel count), 4 5 only in 96k and 192k modes
	<input type="checkbox"/> <input type="checkbox"/> Quad wire (quarter channel count), 4 5 only in 192k mode
	<input type="checkbox"/> <input type="checkbox"/> Single wire, 4 5 SPDIF (consumer) format for metadata

AUX-MADI-COAX AUX-MADI-OPTO AUX-MADI-SFP	<input type="checkbox"/> 96k frame* ³ 4	<input type="checkbox"/> <input type="checkbox"/> 64ch output* ³ 5 6
	<input type="checkbox"/> 48k frame ³ 4	<input type="checkbox"/> <input type="checkbox"/> 57ch (use for DiGiCo stagebox control) ³ 5 6
		<input type="checkbox"/> <input type="checkbox"/> 56ch output ³ 5 6
		<input type="checkbox"/> <input type="checkbox"/> reserved 5 6

AUX-WORDCLOCK	<input type="checkbox"/> True to samplerate* ³ 4
	<input type="checkbox"/> Always x1 (single speed) ³ 4



















* Default setting

For cards not listed, refer to the manual of the respective card, or check for a newer version of this manual.

³ Applies to outputs only. Input format is always auto-detected, regardless of the switch setting



7.3. FlexLink channel mapping (DIP7..9)

The FlexLink interface can transmit 192x192 channels, organized in three lanes with 64 channels each. The channel assignment can be adjusted to meet the user's needs, particularly when the device is used in double-FLX configuration (to make sure that all interfaces and channels are mapped to the desired target on the peer FLX device).

DIP	Lane 1 (ch1-64)	Lane 2 (ch65-128)	Lane 3 (ch129-192)
   7 8 9	MADI SFP	MADI Coaxial	AUX
   7 8 9	MADI SFP	AUX	MADI Coaxial
   7 8 9	MADI Coaxial	MADI SFP	AUX
   7 8 9	MADI Coaxial	AUX	MADI SFP
   7 8 9	AUX	MADI SFP	MADI Coaxial
   7 8 9	AUX	MADI Coaxial	MADI SFP

* Default setting



8. SPECIAL OPERATING MODES





Special operating modes are accessible by *holding down the*  **Mode** *button while switching on the device.* Press  **Mode** again to switch to the next mode:



8.1. Version Display



- The firmware version "X.Y" and the hardware version "Z" are shown on the LEDs on the front panel:

- The number of  pink LEDs lit indicate the major firmware number "X"
- The number of  orange LEDs lit indicate the minor firmware number "Y"
- The number of  green LEDs lit indicate the hardware version "Z"

Example: One (1)  pink LED and three (3)    orange LEDs means "Firmware 1.3", zero green LEDs mean HW version 0.



- Blinking LEDs mean that the currently installed firmware is a "beta" version. It is advised to upgrade to an official release version as soon as it is released.
- Press  **Mode** again to proceed to LED test.

8.2. LED Test

- All LEDs on the front and on the back should show  white.
- Press  **Mode** again to proceed to Interface Self-Test.

8.3. Interface Self-Test

All built-in interfaces and the optional AUX card can be tested for correct operation by the user. This is done using the special self-test mode, in which the device outputs a special random test pattern on all channels. This pattern is looped back via an external cable into the corresponding inputs, where it is checked for consistency.

- Self-test mode is indicated with "CLOCK" showing INT/48kHz in  cyan color. The "MODE" LEDs indicate  red (error/no connection) or  green (loopback data received ok) for the respective interface.
- Connect the Output to the Input of the MADI SFP Port using an optical cable.

- Connect the Output to the Input of the MADI Coaxial Port using an coaxial (BNC) cable with 75 Ohms impedance.
- If an AUX card is installed, connect all output ports of the AUX card to the respective inputs using a loop-back cable. Note: NOT supported with AUX-ADC, AUX-AES67, AUX-AVB, AUX-DANTE.

8.4. Firmware update

The firmware can be updated from any **Windows PC** over the rear **USB** port.

► **To update:**

- Download the latest firmware from www.appsys.ch/FLX-MADI
- Unpack the firmware package FLX-MADI-Firmware_x.y.zip
- Connect your PC via USB to the flexiverter
- Power ON the device
- Run the **FLX-MADI_Updater.bat** file from the firmware package and follow the instructions on the screen.
- Power cycle the device to effect the update.



Thanks to the special design of the updater, it is virtually impossible to damage ("brick") the device during update. If updating fails or is interrupted, restart the procedure. You can also can go back to any older firmware version at any time.

9. SPECIFICATIONS

Parameter	Value	
Dimensions	152x44x153mm (WxHxD) excluding connectors/buttons 152x44x169mm (WxHxD) including device-side connectors/buttons	
Weight	560g	
Operating temperature	0.. +55°C, non-condensing	
Storage temperature	-40.. +85°C, non-condensing	
Power consumption	+15V DC, 9W max (18W to power two devices via FlexLink) Triple-redundant input (2x DC, 1x via FlexLink)	
Supported SFPs	Ships with 1310nm, 125MBit Multimode SFP Accepts any SFP (not SFP+) modules. No vendor lock.	
Cable lengths	FlexLink	1m/3ft. max. recommended
	MADI SFP	Depending on SFP type: Multimode 500m/1600ft (up to 2km/1.2mi with Extended Range SFP), Singlemode 10km/6mi (up to 80km/50mi with Extended Range SFP)
	MADI Coaxial	70m/230ft.
Channel count	128x128 @ 48kHz 64x64 @ 96kHz, 32x32 @ 192kHz plus additional AUX channels depending on AUX card	
Sample rates	44.1kHz, 48kHz, 88.2kHz, 96kHz, 176.4kHz, 192kHz	
Latency	Conversion MADI < > FlexLink: 2 samples Conversion MADI < > AUX: 4 samples plus AUX card latency (depending on AUX card)	
Internal clock precision	Jitter: Phase RMS: < 1ps, Peak-peak: < 50ps. Stability: ± 25 ppm including all effects including aging, temperatur, supply, calibration, shock, vibration	

10. ACCESSORIES

10.1. Rack mount kits

For integration in 19" racks, two kinds of rack mount kits / brackets are available:

- **RM-FLX1:** For mounting one FLX device into 1U 19" space
- **RM-FLX2:** For mounting two FLX devices into 1U 19" space

10.2. Additional (redundant) power supply

- **PWR-FLX:** Additional power supply to provide redundancy for single-FLX configurations
- **FlexLink Cable 0.5m.** HDMI cable with locking screws

11. APPENDIX

11.1. Warranty

We offer a full two (2) year warranty from the date of purchase. Within this period, we repair or exchange your device free of charge in case of any defect*. If you experience any problems, please contact us first. We try hard to solve your problem as soon as possible, even after the warranty period.

* Not covered by the warranty are any damages resulting out of improper use, willful damage, normal wear-out (especially of the connectors) or connection with incompatible devices.

11.2. Manufacturer contact

Appsys ProAudio
Rolf Eichenseher
Bullingerstr. 63 / BK241
CH-8004 Zürich
Switzerland

www.appsys.ch
info@appsys.ch
Phone: +41 43 537 28 51
Mobile: +41 76 747 07 42

11.3. FCC Compliance

This equipment has been tested and found to comply with the limits for a class B digital device, pursuant to part 15 of the FCC Rules. These limits are designed to provide reasonable protection against harmful interference in a residential installation. This equipment generates, uses and can radiate radio frequency energy and if not installed and used in accordance with the instructions, may cause harmful interference to radio communications. However, there is no guarantee that interference will not occur in a particular installation. If this equipment does cause harmful interference to radio or television reception, which can be determined by turning the equipment off and on, the user is encouraged to try to correct the interference by one or more of the following measures:

- Reorient or relocate the receiving antenna
- Increase the separation between the equipment and receiver
- Connect the equipment into an outlet on a circuit different from that to which the receiver is connected
- Consult the dealer or an experienced radio/TV technician for help

This equipment has been verified to comply with the limits for a class B computing device, pursuant to FCC Rules. In order to maintain compliance with FCC regulations, shielded cables must be used with this equipment. Operation with non-approved equipment or unshielded cables is likely to result in interference to radio and TV reception. The user is cautioned that changes and modifications made to the equipment without the approval of manufacturer could void the user's authority to operate this equipment.

11.4. Recycling



According to EU directive 2002/96/EU, electronic devices with a crossed-out dustbin may not be disposed into normal domestic waste. Please return the products back for environment-friendly recycling, we'll refund you the shipping fees.

11.5. Document Revision History

1: Initial release

11.6. About this document

All trademarks mentioned in this document are property of the respective owners. All information provided here is subject to change without prior notice.

Document Revision: 1 · 2021-11-29

Copyright © 2021 Appsys ProAudio · Printed in Switzerland

IDENT 9.00.16146.00

Declaration of Conformity

The manufacturer:

**Appsys ProAudio
Rolf Eichenseher
Bullingerstr. 63 BK 241
CH-8004 Zürich
Switzerland**

declares under sole responsibility that the products mentioned below:

Flexiverter FLX-MADI

meet the requirements of the following standards:

**EN 55024:2010
EN 55032:2015 Class B
EN 61000-3-2:2006/A1/A2:2009
EN 61000-3-3:2009
EN 61000-6-3:2007/A1:2011**

Therefore the product fulfills the demand of the following EC directives:

73/23/EWG

(Directive related to electrical equipment designed for use within certain voltage limits)

89/336/EWG

(Directive related to electromagnetic compatibility)

The devices are marked accordingly.

Zürich, 21.11.2021



Rolf Eichenseher (CEO)