



**SOUND  
PARTICLES**



# **Energy Panner**

## Reference Manual

March 2021  
v 1.1.0



## Welcome Note

Welcome to “Energy Panner”

As you know, at Sound Particles we love to explore sound and space. And yes, you can use traditional panners to move sounds around, but we are always trying to think about crazy ideas for new ways of handling space, and “Energy Panner” is one of those strange ideas – a panner which is controlled by the intensity of the sound.

One day I was listening to music in the car after leaving the kids at school, and I started to imagine the drums moving according to the beat, and that was the beginning of “Energy Panner”.

Enjoy! And if you have any question or suggestion, don’t hesitate to contact us. We REALLY love to receive feedback from our users.

**Nuno Fonseca, PhD**

CEO

**[nuno.fonseca@soundparticles.com](mailto:nuno.fonseca@soundparticles.com)**

# Table of Contents

<b>Table of Contents</b>	<b>3</b>
<b>Energy Panner</b>	<b>4</b>
Energy Panner Signal Flow	5
Interface	6
Effect Modes	10
Output Options	12
<b>Additional Notes</b>	<b>18</b>
<b>EULA</b>	<b>19</b>

# Energy Panner

Thank you very much for downloading the Energy Panner audio plugin from Sound Particles. Energy Panner is committed to change the way you use sound in space, enriching your mixes by spreading sound around you. This unique audio plugin makes panning easier than ever, by applying movement to your sounds using compressor-type parameters to the level of the audio signal.

Designed to be simple and quick to use, Energy Panner has two different modes of operation — Pan and Sliding — enabling sound designers and music producers to use this new approach to panning in several different ways. Whether to add motion to sound effects or to creatively mix instruments, this audio plugin will change the way you think about the sound around you.

Energy Panner brings the most innovative panning solution to your DAW. Allows you to move your sound around dynamically in a variety of reproduction formats — from stereo to surround 5.1 and 7.1, to Dolby Atmos 7.1.2, Ambisonics up to 3rd order, and Binaural.

Go through this manual and get the best out of Energy Panner!

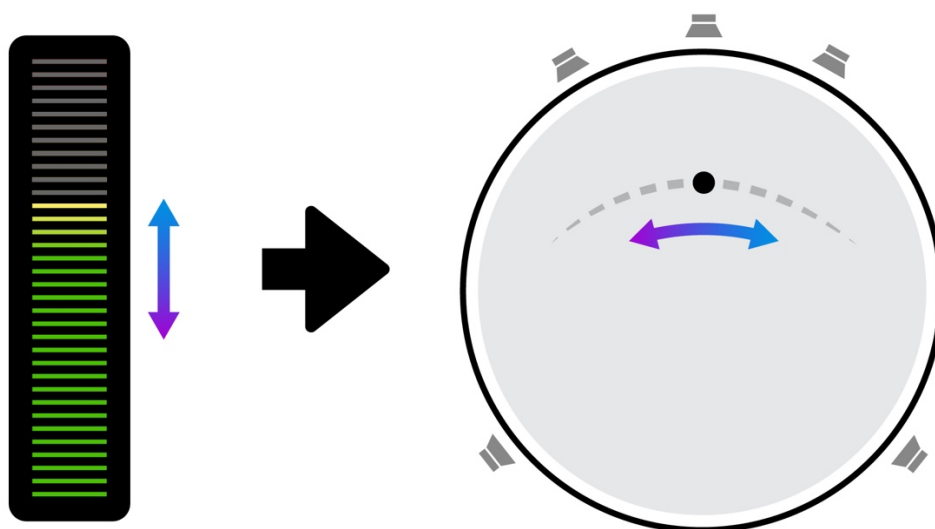

# Energy Panner Signal Flow

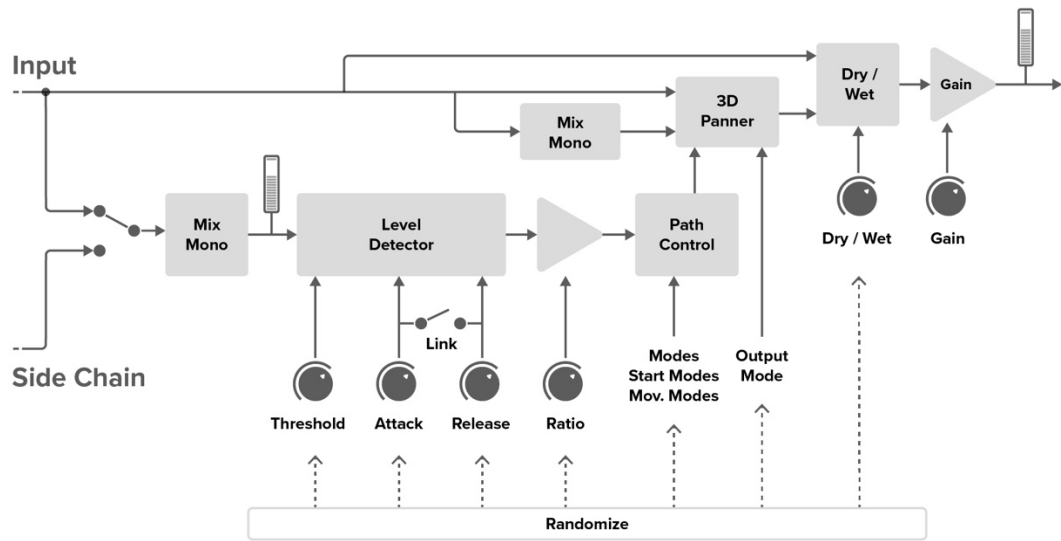

## Interface

The interface of Energy Panner is designed to be easy-to-use and straightforward while providing all information and controls you need to attain the best out of the plugin.

Energy Panner has a key element centered on the interface, the dome. Here, you will probably carry out the largest proportion of your actions, since it's here you can define the outstanding effects Energy Panner applies to your sounds.

In addition to the dome, there are a whole set of parameters around it that will help you to hit the sound you want. Above the dome are the two modes of operation: Pan and Sliding. Switching between these two modes will completely change the way Energy Panner works as well as changing the dominant colors on the interface. From the left side, you define basic components related to your sound effect position and its behavior.

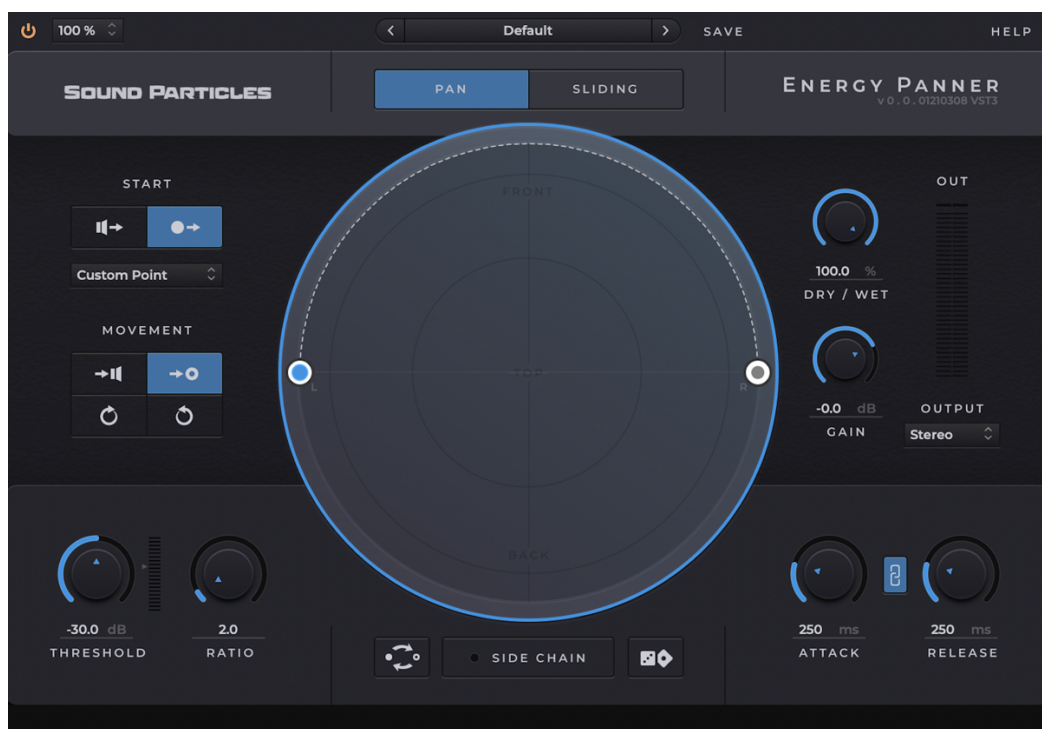

## Understanding the Dome

The dome is a key element on the interface and fundamental to get the best out of Energy Panner. It is where users can define and view:

- 1) the Start handle** - start position of the audio source;
- 2) End/Movement handle** - sets the target position of the audio source;
- 3) the Position indicator** - displays the current position of the audio source (blue circular particle).

When moving these handles in the circle space you are outlining a panning trajectory of your sounds in a cupola-like space, being the output processed as if you were centered in this space. For example, a sound source initially positioned in the center of the dome will be perceived as being above us. If you define its trajectory to go back point, the final result will be a sound initially coming from above to behind us.

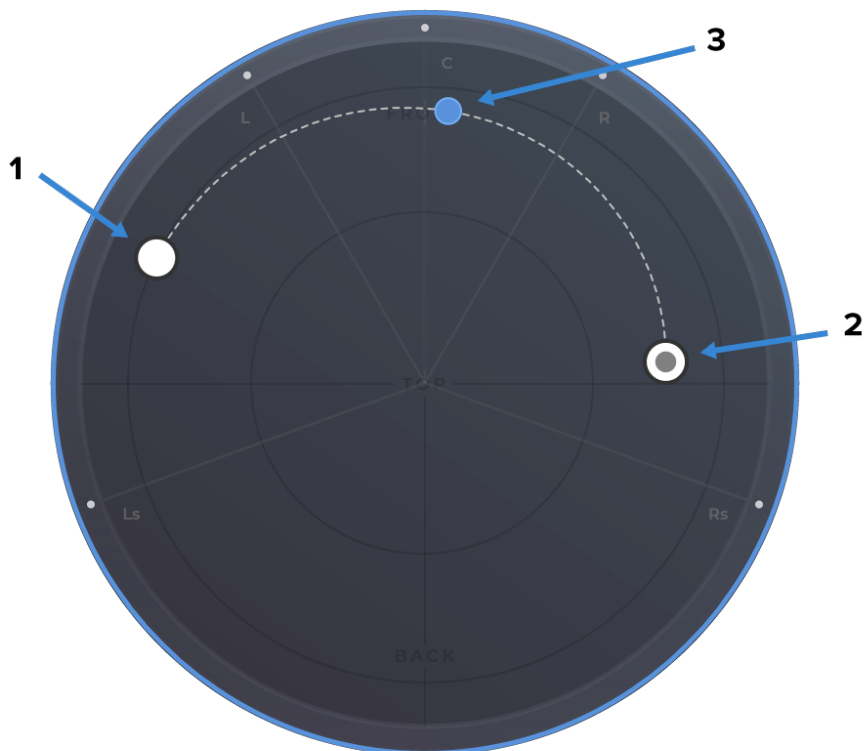

The dome is the main playground of Energy Panner. Using our set of parameters, you can add complex movements and trajectories to sound sources that you simply cannot achieve with traditional automation.

## Panning Modes

The Energy Panner plugin has two panning modes — Pan and Sliding — that will help you in creating a greater variety of trajectories. These two modes will use the energy of your sound source and use it differently to distribute the sound around you.

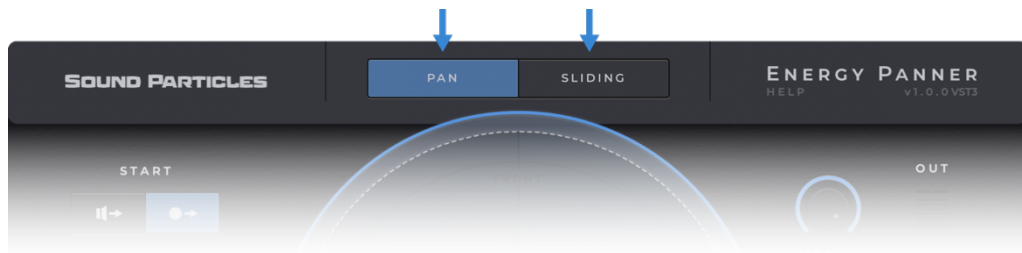

### Pan

The Pan mode is essentially a normal end-to-end particle-based panning. This type of panning effect changes the position of the sound source between two points (start point -> end point) previously defined by you. Therefore, the greater the energy of the input signal the greater the shift from the starting point to the end point. The example below demonstrates how pan mode works on the Energy Panner plugin.

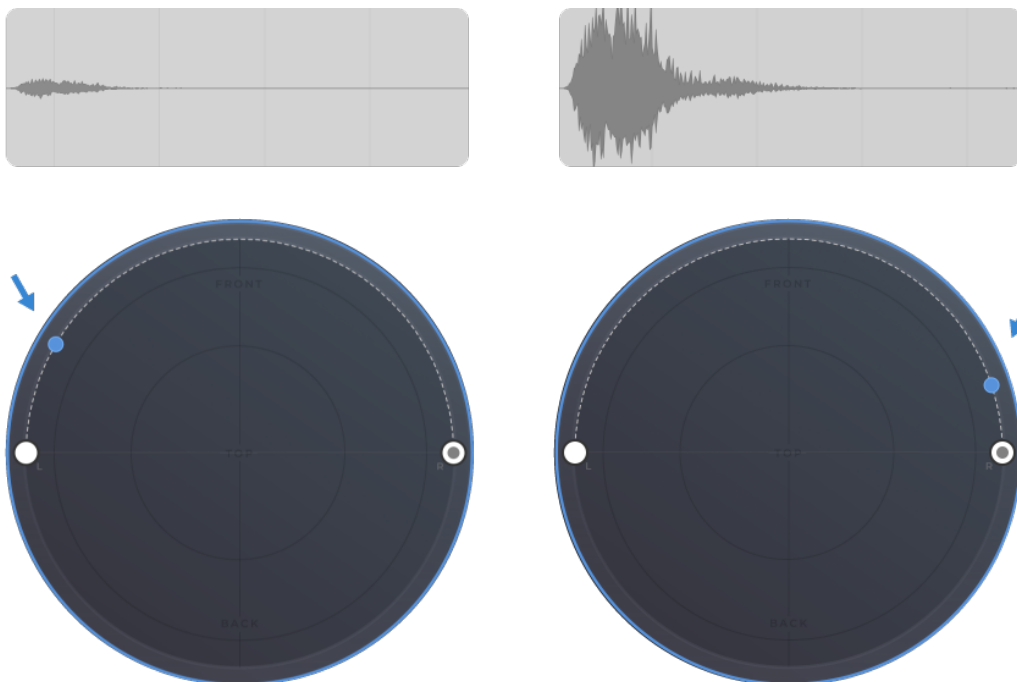



## Sliding Mode

The sliding mode works in its essence as continuous particle sliding/rotation-based panning. Whenever the audio signal reaches a certain level (threshold value), the sound source moves on a trajectory that you define. As opposed to pan mode, the sound source does not return to the starting point as soon as the signal level drops. The sound source will freeze in that position until the audio signal exceeds the threshold value again, leading to a new shift of the sound source in the dome space. It's almost as if we had a sound source "walking" around the dome.



## Effect Modes

### Start Location

The effect modes in the Energy Panner refer to a set of factors able to modify the trajectory of the sound source, allowing to create a greater variety of sonic results. Basically, the Energy Panner effects section defines the essence of the effect we want to create.

Initially, you start by defining the start point's form and location. We can define the starting point form by:

- 1) **Start in Speakers Mode** - Sets the panning effect to start in the original input channel(s) position(s).
- 2) **Start in Point Mode** - Sets the panning effect to start in a given point. In this mode, the plugin output starts as a mono downmixed signal.

When the users select the start location in point mode, there is an option to choose from a list of selectable predefined positions for the start point.

### Movement Type

Once you have selected the mode and starting position, Energy Panner lets you choose a type of movement for the sound source. The options are:

- 3) **To Speakers Movement** - Sets the panning effect to move towards the original input channel(s) position(s).
- 4) **To Point Movement** - Sets the panning effect to move towards a destination point.
- 5) **Clockwise Movement** - Sets the effect to rotate in a clockwise direction.
- 6) **Counter-clockwise Movement** - Sets the effect to rotate in a counter-clockwise direction.

Energy Panner has an invert Pan button that lets you invert the current panning motion of the sound source.



## Main Parameters



### Threshold

The Threshold knob sets the minimum level needed for the panning effect to be activated. The Energy Panner panning effect will open faster with a smaller threshold. It always depends on your audio to find a good setting, and the input VU meter right next to the knob will help you set the right level.

The starting color of the threshold knob is blue/orange, depending on the mode you're working on. However, once the audio signal exceeds the threshold value, the color of the button will turn green and the panning effect starts. Also, the input VU meter starts to show green lines.

### Ratio

The Ratio knob sets the amount of panning that occurs when the input level surpasses the threshold value. The higher the ratio value, the higher the amount of panning to the sound source. For example, there is no movement if you shift the knob absolutely to the left (1:1). On the other hand, if you move it completely to the right (100:1), the result will be a higher amount of movement.

### Attack

The Attack knob sets the speed at which the sound source moves when the signal level exceeds the threshold value, ranging from 1ms (very fast) to 5000ms (very slow). This wider range of attack time makes Energy Panner capable of dealing with a great variety of sound sources, from percussive to drone sounds.

## Release

The Release knob sets the amount of time that takes for the decreasing panning effect to occur, ranging from 1ms (very fast) to 5000ms (very slow). Just like the attack parameter, the behavior is very dependent on the case scenario, heavily relying on the audio you are processing. Just like attack parameter, very low values of these parameters can add some distortion to your sound source.

## Link Option

The Energy Panner has an option called Link that allows the attack and release parameters to be equal. This means that attack and release times can be controlled together or separately (link On/Off).

## Sidechain

The Energy Panner offers the possibility of feeding the plugin with any external signal of your mix, triggering the panning effect with a different signal than the audio it is actually processing. Applying the sidechain technique to the plugin inputs may work slightly different across the DAWs.

## Output Options

The Energy Panner has an output section dedicated to the parameters that change the already processed audio. These parameters are the Dry/Wet, Gain, and the output popup for the render formats.

The Dry/Wet knob controls the amount of dry (without movement) input signal that is added to the output. This is essentially the ratio between the input and processed signal.

The Gain Knob controls the gain of the output signal. The current signal levels are visible in the VU meters available on the right-side of the interface. Users can access a popup menu by right clicking on the VU's. This essentially allow users to reset the VU's animation (e.g.: if they already clipped), as well as viewing the render format in use. When inserted into a multi-channel track, Energy Panner lets you switch the VU's channel order between SMPTE and Film.

## Output Render Formats

- **Stereo** - A stereo render made of gains based in the channel particle position.
- **Stereo(XY)** - A stereo render made with a virtual XY microphone.
- **Stereo(MS)** - A stereo render made with a virtual MS microphone.
- **Stereo (Blumlein)** - A stereo render made with a virtual Blumlein microphone.
- **Binaural** - A binaural render based on the SADIE MINP KU100 dataset.
- **Ambisonics (ACN/SN3D)** - An ambisonics render based on the ambisonics input.
- **5.0** - A 5.0 VBAP multichannel render
- **5.1** - A 5.1 VBAP multichannel render.
- **7.0** - A 7.0 VBAP multichannel render.
- **7.1** - A 7.1 VBAP multichannel render.
- **7.0.2** - A 7.1.2 VBAP multichannel render.
- **7.1.2** - A 7.1.2 VBAP multichannel render.

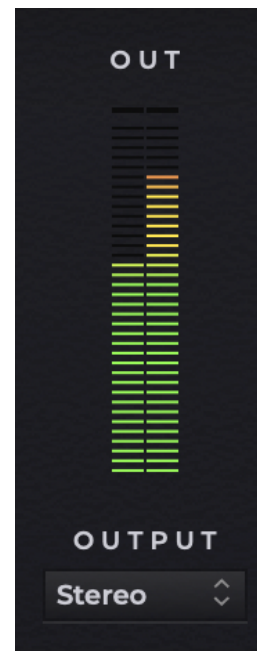

## Energy Panner Toolbars



The Energy Panner toolbar incorporates a set of features that assists you when using the plugin. The upper tab allows you to save and manage presets very quickly and intuitively. Also, the scaling and smooth bypass feature streamline working with Energy Panner.

- 1) **Smooth Bypass** — noiseless plug-in activation / deactivation. Using this feature the Energy Panner is bypassed without any clipping, even if it's processing audio.
- 2) **GUI Zoom** — the Energy Panner's GUI can be resized. The available popup on the upper-left part of the interface let users choose a scaling value, from 25% to 400%. This action affects only the currently selected Energy Panner instance. New instances of the plugin will open with the default resize factor (100%). Also, users are allowed to use a custom scaling factor by dragging the cursor in the bottom-right of the plugin's interface. Performing this makes the zoom popup display the custom value of the scaling.

*\*Bear in mind that hosts may deal differently with plugins resize.*

3) **Internal Preset Saving System** — The internal system for recording presets is a new feature implemented from this version (v.1.1.0). It allows greater management of the presets, enabling users to: create snapshots, alter presets, and access all of them (factory and custom) across all your hosts.

A. **Preset Navigator** — allow users to navigate to the previous and next preset using the arrows placed on the left and right of the Preset popup menu.

B. **Preset Popup Menu** — the preset popup displays the current preset in use. It initially appears with a preset called Default, used whenever the plugin is inserted into a track. Pressing on the name of the preset brings up a menu with the options: **Delete preset**, **Set as default preset**, and **Refresh preset list** — followed by the complete list of presets (factory and custom).

B1. **Set as default preset** — defines the current plugin settings as the default settings when the plugin is inserted into a new track. This action determines the default on all hosts and architectures.

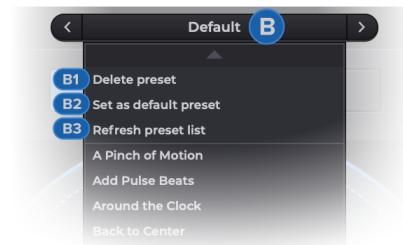

B2. **Refresh preset list** — updates the presets list. If there is a new preset file in the presets folder, or a new preset has been created from a different Energy Panner instance, this option updates the preset list.

B3. **Delete preset** — deletes the current preset. This action is permanent and deletes the preset on all hosts.

C. **Save** — Pressing “Save” label saves the current state of Energy Panner as a preset. The operating system window will automatically appear in the required directory. Presets saved in different paths won't be recognised in the preset menu of the plugin.

4) **Update** — If the plug-in is running on a computer with internet access, it is able to detect if a newer update is available, informing the user of the existence of a new update, by showing a blinking phrase on the top of the display.

5) **Help** — link to the web version of this manual.

## Plugin Installation

The Energy Panner Plugin installation copies the plugin into appropriate plugin folders, and the hosts will automatically recognize them. It also allows Energy Panner users to choose a custom folder for the installation, in both operating systems — MacOS and WindowsOS.

On MacOS, the default paths for Energy Panner plugin architectures are the following:

- /Library/Audio/Plug-Ins/VST3
- /Library/Audio/Plug-Ins/Components
- /Library/Application Support/Sound Particles/EnergyPanner
- /Library/Application Support/Avid/Audio/Plug-Ins

On WindowsOS, the default paths for Energy Panner plugin architectures are the following:

- C:\Program Files\Common Files\VST3
- C:\Program Files\Common Files\Avid\Audio\Plug-Ins

In the case of VSTs on WindowsOS, we set the paths in accordance with [Steinberg recommendation](#) regarding plugin locations.



## Tips

### Knobs:

- Double click or Alt-click resets to the default value;
- Command, Ctrl or Shift while dragging enables fine-tune.

### VU meter:

- Click on one channel clears its clipping led;
- Double click and press reset clears all clipping LEDs;
- In multichannel scenarios it is possible to choose the VU's channel order (SMPTE/Film).

### Dome:

- Shift while dragging a handle to give it a negative elevation;
- Use Ctrl or Command while dragging a handle to give it rounded values (snaps to a 5° grid).

### Randomize:

- This button will set new random values to the parameters and the plugin effect mode buttons/popups.

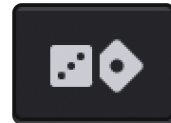

### Tooltips bar:

- This version of Energy Panner has a bar at the bottom of the interface that shows short definitions for each element of the plugin.

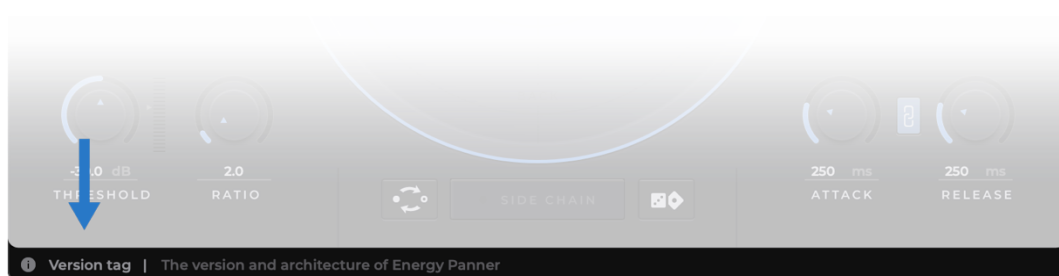

# Additional Notes

## Avid S6 Support

Energy Panner (AAX) can have its parameters controlled through various control surfaces, including AVID S6.

## Check for updates

If the plug-in is running on a computer with internet access, it is able to detect if a newer update is available, informing the user of the existence of a new update, by showing a blinking phrase on the top of the display.

To achieve that, Sound Particles Energy Panner plugin tries to access a simple XML file located at <https://www.soundparticles.com>.

SOUND PARTICLES ENERGY PANNER DOES NOT SEND ANY INFORMATION FROM THE USER OVER THE INTERNET.

## Support

If you detect a bug, if you got a crash, if you believe something is not perfect, or even if you have ideas for future versions, don't hesitate, and email us at [support@soundparticles.com](mailto:support@soundparticles.com). We REALLY want to hear from you. Sometimes a bug lives on for too much time, simply because we haven't detected ourselves and we didn't receive any feedback from the affected users. Besides that, your feedback is very important for us.

"Help us help you"

# EULA

END USER LICENSE AGREEMENT OF SOUND PARTICLES – JANUARY 2020

## I. GENERAL

The following End User License Agreement ("EULA") represents an agreement between you ("Licensee") and "Sound Particles, S.A.", with head office at IDD, Rua da Carvalha, 570, 2400-441 Leiria, Portugal (hereinafter "Sound Particles") for the use of software including related media documentation (for example, program descriptions and manuals) and other documents and materials manufactured by Sound Particles (the "Product(s)").

By installing the software on your computer, you declare yourself in agreement with these conditions. If you do not agree with these conditions, you must not install the software or use it.

## II. SCOPE OF USE

The Products are intellectual property of Sound Particles and are protected by law. Licensee, as purchaser of the Products, acquires only a limited, non-exclusive and non-transferable license to use, personally or professionally, the Products. Any other use or exploitation not explicitly granted to Licensee in this EULA shall not be allowed without prior written consent from Sound Particles. Specifically, Licensee is not entitled to copy, decompile, reverse engineer the Product or parts thereof, create derivative works from the Products or sublicense or provide the Products as "software as a service".

Licensee must ensure by appropriate and reasonable steps that third parties, including its own employees, cannot make unauthorized use of the Product. Licensee shall be liable to Sound Particles for any loss or damage in this context.

The Software is being licensed to you and you hereby acknowledge that no title or ownership in the Software is being transferred or assigned and this EULA is not to be construed as a sale of any rights in the Software. Sound Particles retains all right, title and interest in the Products, including, but not limited to, all copyrights, trademarks, trade secrets, trade names, proprietary rights, patents, titles, computer codes, audiovisual effects, themes, settings, artwork, sound effects, musical works, and moral rights whether registered or not and all applications thereof.

1. Sound Particles grants Licensee the non-exclusive right without restrictions in time or place to use the Products. Sound Particles is not obliged to disclose the Products' software underlying source code, including the associated development documentation.
2. Licensee may either:
  - a) Install and use the licensed Products' software on several devices (e.g. one laptop, one desktop), provided that the said software is used only by the same single person - Per user licensing. Simultaneous use on more than one hardware device is not permitted.
  - b) Install the licensed Products' software on a single device, allowing its use by several users on the device (e.g. studio computer) - Per seat licensing.
3. Licensee may copy the licensed Products' software, only if such reproduction is necessary for the contractually agreed use. Licensee is authorized to create a backup, only if this is necessary to secure the future use.
4. Licensee is not authorized to modify the Products' software.
5. Licensee shall not attempt to develop any software that contains the "look and feel" of any of the Products' or is otherwise derivative of its software.
6. Third Parties
  - a) Renting or lending the licensed Products' software to a third party is expressly forbidden. Apart from that and if not provided otherwise within this EULA, Licensee may leave the software to a third party for a certain amount of time, if the third party agrees to the terms of this EULA and Licensee does not use the software during this period.
  - b) Except if otherwise stated within this EULA, Licensee may resell the software to a third party or transfer the software permanently free of charge, provided the third party agrees in writing with this EULA and Licensee ceases all use of the software, completely removes all installed copies of the software from its computer and – if the software was not purchased via download – deletes or transfers the original data storage to the third party (if Licensee is not obliged to a longer storage by law). In addition, Licensee is required to de-register the purchased software with Sound Particles. Following respective request from Licensee via its email address registered with Sound Particles, the serial number of the Product will be transferred by Sound Particles to the third party, and at the same time the registration of Licensee for the Product purchased will be deleted.

c) Licensee may not (i) distribute, lease, license, sell, rent, lend, convey or otherwise transfer or assign the Products or any copies thereof, (ii) make publicly available or available on a network for use or download by multiple users, (iii) remove, obscure or modify any copyright, trademark or other proprietary rights notices, marks or labels contained on or within the Products, falsify or delete any author attributions, legal notices or other labels of the origin or source of the material

7. In addition, for certain Products from Sound Particles the following shall apply:

a) Bundles (product bundles consisting of hardware and software or software-only bundles) can only be resold / transferred as a whole. The individual components of a bundle must not be resold / transferred separately.

b) Any Products from Sound Particles labeled or otherwise provided to you as "NFR" (Not For Resale) shall only be used for demonstration, testing and evaluation purposes. NFR Products must not be used for commercial purposes, and must not be resold or transferred. NFR Products are exempt from update, upgrade or crossgrade offers and cannot be purchased with or exchanged for vouchers or coupons.

c) Any Products from Sound Particles labeled or otherwise provided to you as an EDU (Educational) version shall only be used by students or those working in educational institutions. This definition includes students, faculty, staff and administration attending and / or working at an educational institutional facility: private / public schools, training facilities, colleges, universities and similar. EDU Products must not be used for commercial purposes, and must not be resold or transferred. EDU Products are exempt from update, upgrade or crossgrade offers, and cannot be purchased with or exchanged for vouchers or coupons.

d) Any Products from Sound Particles labeled or otherwise provided to you as "Demo Versions" or similar, shall only be used for demonstration, testing and evaluation purposes. Demo Versions must not be used for commercial or public purposes, and must not be resold or transferred.

If you are not sure which license type you own – (FULL / NFR / EDU) – please contact our Support Team.

### **III. THIRD PARTY RIGHTS**

Some content included in Sound Particles software Products, as well as any associated intellectual property rights and titles, belongs to third parties. This content may be protected by copyright or other intellectual property laws and treaties and may be subject to terms and conditions from the third party providing the content.

FFmpeg Notice - The Software utilizes the FFmpeg video application and its included libraries. FFmpeg is a trademark of Fabrice Bellard (originator of the FFmpeg project - FFmpeg project, <http://www.ffmpeg.org>) licensed under the [GNU Lesser General Public License 3.0](#) and its source can be downloaded [here](#).

### **IV. DUTIES TO PROTECT**

Copyright notices, serial numbers and other identification features of the program may not be removed from the software or altered in any way.

### **V. WARRANTY, LEGAL LIABILITY, DAMAGES**

DISCLAIMER OF WARRANTIES: YOU EXPRESSLY ACKNOWLEDGE AND AGREE THAT USE OF THE SOFTWARE IS AT YOUR SOLE RISK AND THAT THE ENTIRE RISK AS TO SATISFACTORY QUALITY, PERFORMANCE, AND ACCURACY IS WITH YOU. TO THE MAXIMUM EXTENT PERMITTED BY APPLICABLE LAW, THE SOFTWARE IS PROVIDED "AS IS," WITH ALL FAULTS AND WITHOUT WARRANTY OF ANY KIND, AND SOUND PARTICLES HEREBY DISCLAIMS ALL WARRANTIES AND CONDITIONS WITH RESPECT TO THE SOFTWARE PRODUCT, EITHER EXPRESS, IMPLIED OR STATUTORY, INCLUDING, BUT NOT LIMITED TO, THE IMPLIED WARRANTIES AND/OR CONDITIONS OF MERCHANTABILITY, OF SATISFACTORY QUALITY, OF FITNESS FOR A PARTICULAR PURPOSE, OF ACCURACY, OF QUIET ENJOYMENT, AND NON-INFRINGEMENT OF THIRD PARTY RIGHTS. SOUND PARTICLES DOES NOT WARRANT AGAINST INTERFERENCE WITH YOUR ENJOYMENT OF THE SOFTWARE, THAT THE FUNCTIONS CONTAINED IN THE SOFTWARE WILL MEET YOUR REQUIREMENTS, THAT THE OPERATION OF THE SOFTWARE WILL BE UNINTERRUPTED OR ERROR-FREE, OR THAT DEFECTS IN THE SOFTWARE WILL BE CORRECTED. NO ORAL OR WRITTEN INFORMATION OR ADVICE GIVEN BY SOUND PARTICLES OR A SOUND PARTICLES AUTHORIZED REPRESENTATIVE SHALL CREATE A WARRANTY. SHOULD THE SOFTWARE PROVE DEFECTIVE, SOUND PARTICLES MAY CHOOSE TO REPLACE THE LICENSEE'S COPY OF THE SOFTWARE. SOME JURISDICTIONS DO NOT ALLOW THE EXCLUSION OF IMPLIED WARRANTIES OR LIMITATION ON APPLICABLE STATUTORY RIGHTS OF A CONSUMER, SO THE ABOVE EXCLUSION AND LIMITATIONS MAY NOT APPLY TO YOU. THIS LIMITATION OF WARRANTY SHALL NOT BE APPLICABLE SOLELY TO THE EXTENT THAT ANY SPECIFIC

PROVISION OF THIS LIMITATION OF LIABILITY IS PROHIBITED BY ANY LAW, WHICH CANNOT BE PRE-EMPTED.

LIMITATION OF LIABILITY: TO THE MAXIMUM EXTENT PERMITTED BY APPLICABLE LAW, IN NO EVENT SHALL SOUND PARTICLES OR ITS AFFILIATES BE LIABLE FOR ANY SPECIAL, INCIDENTAL, INDIRECT OR CONSEQUENTIAL DAMAGES WHATSOEVER (INCLUDING, WITHOUT LIMITATION, DAMAGES FOR LOSS OF BUSINESS PROFITS, BUSINESS INTERRUPTION, LOSS OF BUSINESS INFORMATION, OR ANY OTHER PECUNIARY LOSS) ARISING OUT OF THE USE OF OR INABILITY TO USE THE SOFTWARE OR DEFECT IN OR CAUSED BY THE SOFTWARE, INCLUDING BUT NOT LIMITED TO COMPROMISING THE SECURITY OF YOUR COMPUTER, OPERATING SYSTEM OR FILES, OR THE PROVISION OF OR FAILURE TO PROVIDE SUPPORT SERVICES, EVEN IF SOUND PARTICLES HAS BEEN ADVISED OF THE POSSIBILITY OF SUCH DAMAGES. IN ANY CASE, SOUND PARTICLES ENTIRE LIABILITY UNDER ANY PROVISION OF THIS EULA SHALL BE LIMITED TO THE AMOUNT ACTUALLY PAID BY YOU FOR THE SOFTWARE OR REPLACEMENT OF THE SOFTWARE WITH PRODUCT OF COMPARABLE RETAIL VALUE, AS SOUND PARTICLES MAY ELECT IN ITS SOLE DISCRETION. IF SOME JURISDICTIONS DO NOT ALLOW THE EXCLUSION OR LIMITATION OF LIABILITY, THE ABOVE LIMITATION MAY NOT APPLY TO YOU IN PART OR WHOLE. THIS LIMITATION OF LIABILITY SHALL NOT BE APPLICABLE SOLELY TO THE EXTENT THAT ANY SPECIFIC PROVISION OF THIS LIMITATION OF LIABILITY IS PROHIBITED BY ANY LAW, WHICH CANNOT BE PRE-EMPTED.

Licensee agrees to indemnify, defend and hold harmless Sound Particles and its affiliates and their respective officers, employees, directors, agents, licensees (excluding you), sublicensees (excluding you), successors and assigns from and against any and all liability, costs, losses, damages, and expenses (including reasonable attorneys' fees and expenses) arising out of any claim, suit, or cause of action relating to and/or arising from (a) your breach of any term of this EULA; (b) your violation of any rights of any third party; or (c) your use or misuse of the Software. Your indemnification obligations set forth in the immediately preceding sentence shall survive the termination of this EULA.

## **VI. CLOSING PROVISIONS**

1. If any stipulation of this EULA should be or become invalid, either completely or in part, this shall not affect the validity of the remaining stipulations. The parties undertake instead to replace the invalid stipulation with a valid regulation which comes as close as possible to the purpose originally intended.
2. **TERMINATION:** This EULA will terminate automatically if you fail to comply with its terms and conditions. In such event, you must destroy all copies of the Product and all of its component parts (including the software) and cease and desist from accessing any Products.
3. This Agreement shall be governed and construed by the laws of Portugal. The United Nations Convention for the International Sale of Goods shall not apply.

The exclusive place of jurisdiction with respect to all disputes based on or in connection with this Agreement shall be Leiria, Portugal. However, Sound Particles reserves the right to sue Licensee at Licensee's place of residence or place of business.

Should you have any queries concerning this EULA, please write to this address:

Sound Particles S.A.  
IDD, Rua da Carvalha, 570,  
2400-441 Leiria  
Portugal



**SOUND PARTICLES** ENERGY PANNER

**START**  
 [Mute] [Solo] [Start]

Custom Point

**MOVEMENT**  
 [Move] [Reset] [Refresh]

**OUT**  
 100.0 % DRY / WET  
 0.0 dB GAIN  
 OUTPUT 7.0

THRESHOLD -33.9 dB  
 RATIO 2.49

5000 ms ATTACK  
 3107 ms RELEASE

SIDE CHAIN

The interface features a central circular panner with 12 nodes labeled L, C, R, Ls, Cs, Rs, Ls, Cs, Rs, Ls, Cs, Rs. Dashed lines show movement paths between these nodes. The background shows a woman with headphones and a colorful particle visualization consisting of vertical bars in shades of green, yellow, and red.

