



Rear view

This switch requires 4 conductors and is compatible with the following Lowell models (order separately):

SEQR-8-RJ

Sequencer

Single pole single throw, low voltage switch with MOMENTARY closure, for applications that use multiple switches. The switch is connected to a sequencer (ordered separately) to activate equipment.

FEATURES

- **Closure:** Momentary closure
- **Activation:** Rocker switch
- **Two Status Indicators:** The green LED flashes when the unit is powering up and lights steadily when on. The red LED flashes when the unit is powering down, and lights steadily when the unit is off but receiving power (i.e. ready to operate).
- **Connections:** Rear connections are termination strips with wire capacity to 18 gauge. Also includes one RJ45 connector. *Note: The RJ45 connection is only compatible with a Lowell sequencer (SEQ) that has a single RJ45 connector and classic connections, not pass-through connections.*
- **Wall Plate:** Includes 1-gang decorator style wall plate (black plate/sub-plate).
 - The sub-plate can also be mounted in a 19" rackmount panel with suitable openings, in which case the outer plate would not be used. See Lowell panels D3P-ID-1, D3P-ID-2, D8P-ID-3, D9P-ID-3.
 - The sub-plate can also be used in multi-gang decorator style wall plates (by others), in which case the outer plate would not be used.
- **A&E Specifications:** The low voltage switch for remote activation of equipment shall be Lowell Model RPSB2-MP-RJ, which shall operate in conjunction with a power sequencer (ordered separately). The switch shall feature momentary closure, rear connection termination strips with wire capacity to 18-gauge, an RJ45 connector, a black one-gang decorator style wall plate with two LED status indicators, and a rocker activation switch.

TYPICAL WIRING

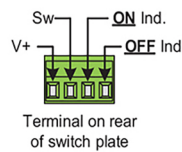
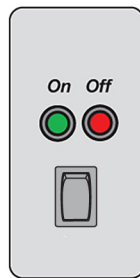

Pins 1, 2 V+
Pins 3, 4 Sw
Pins 5, 6 ON Ind.
Pins 7, 8 OFF Ind.

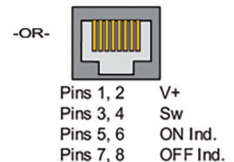
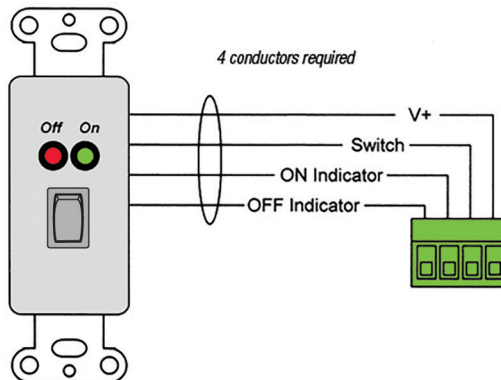
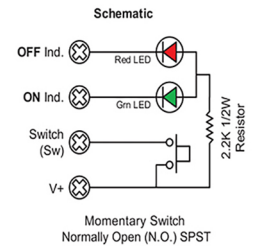

Understanding MAINTAINED vs. MOMENTARY Switches:

- Maintained Switch:** A switch with maintained closure stays in the position you select. When you turn it on, it stays on until you turn it off, and vice versa. An example would be a switch used for a ceiling light, which stays on until you flip the switch to the off position. Specify a maintained switch for applications that use only one switch to control the equipment.
- Momentary Switch:** A switch with momentary closure operates only as long as you press or hold it; the switch returns to its original position as soon as you stop. An example would be a switch for a doorbell, which continues to ring only while you press the switch. Specify momentary switches for applications that utilize more than one switch to control the equipment.

Maintained Switch Schematic Symbol:

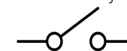

Momentary Switch Schematic Symbol:

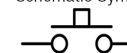

LOWELL RPSB- AND RPSW- SERIES OVERVIEW

Model No.	Closure	Activation	Mounting Style	Color	LED Indicators	RJ45 Connector
RPSB-P	Maintained	Rocker	Wall Plate	Black	1	-----
RPSB-P-RJ	Maintained	Rocker	Wall Plate	Black	1	1
RPSW-KP	Maintained	Key	Wall Plate	White	1	-----
RPSW-KP-RJ	Maintained	Key	Wall Plate	White	1	1
RPSW-P	Maintained	Rocker	Wall Plate	White	1	-----
RPSW-P-RJ	Maintained	Rocker	Wall Plate	White	1	1
RPSB-KP-ASM	Maintained	Key	Wall Plate	Black	1	-----
RPSB-KR	Maintained	Key	19" Rackmount Panel	Black	1	-----
RPSB-KR-RJ	Maintained	Key	19" Rackmount Panel	Black	1	1
RPSB-R	Maintained	Rocker	19" Rackmount Panel	Black	1	-----
RPSB-R-RJ	Maintained	Rocker	19" Rackmount Panel	Black	1	1
RPSB-MKP	<i>Momentary</i>	Key	Wall Plate	Black	1	-----
RPSB-MP	<i>Momentary</i>	Rocker	Wall Plate	Black	1	-----
RPSW-MKP	<i>Momentary</i>	Key	Wall Plate	White	1	-----
RPSW-MP	<i>Momentary</i>	Rocker	Wall Plate	White	1	-----
RPSB2-MKP	<i>Momentary</i>	Key	Wall Plate	Black	2	-----
RPSB2-MKP-RJ	<i>Momentary</i>	Key	Wall Plate	Black	2	1
RPSB2-MP	<i>Momentary</i>	Rocker	Wall Plate	Black	2	-----
RPSB2-MP-RJ	<i>Momentary</i>	Rocker	Wall Plate	Black	2	1
RPSW2-MKP	<i>Momentary</i>	Key	Wall Plate	White	2	-----
RPSW2-MKP-RJ	<i>Momentary</i>	Key	Wall Plate	White	2	1
RPSW2-MP	<i>Momentary</i>	Rocker	Wall Plate	White	2	-----
RPSW2-MP-RJ	<i>Momentary</i>	Rocker	Wall Plate	White	2	1
RPSB2-MKR	<i>Momentary</i>	Key	19" Rackmount Panel	Black	2	-----
RPSB2-MKR-RJ	<i>Momentary</i>	Key	19" Rackmount Panel	Black	2	1
RPSB2-MR	<i>Momentary</i>	Rocker	19" Rackmount Panel	Black	2	-----
RPSB2-MR-RJ	<i>Momentary</i>	Rocker	19" Rackmount Panel	Black	2	1
RPSB-MKR	<i>Momentary</i>	Key	19" Rackmount Panel	Black	1	-----
RPSB-MR	<i>Momentary</i>	Rocker	19" Rackmount Panel	Black	1	-----

