

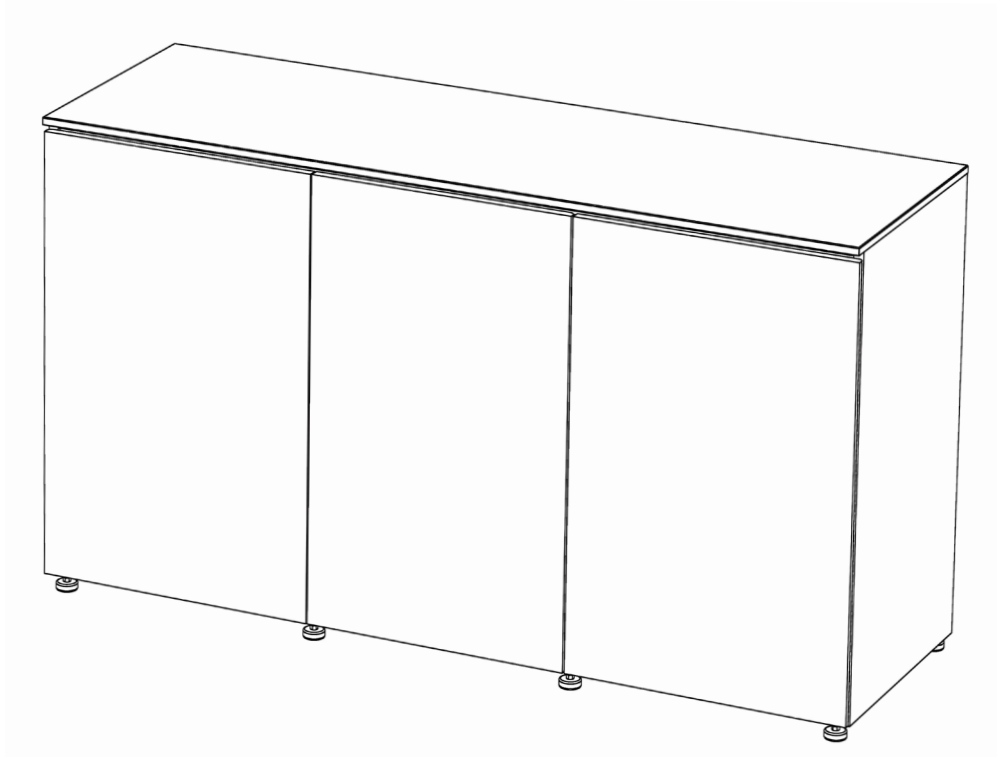

D2/337A ASSEMBLY INSTRUCTIONS

3 BAY AV CREDENZA



HARDWARE

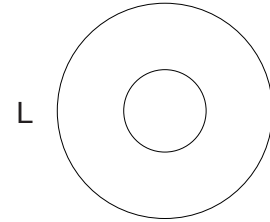
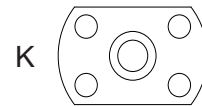
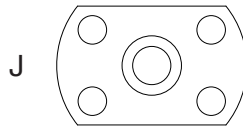
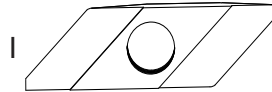
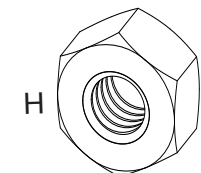
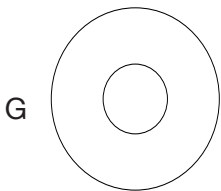
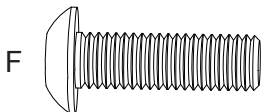
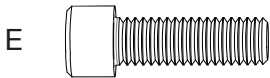
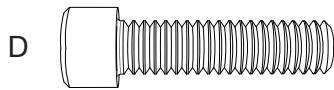
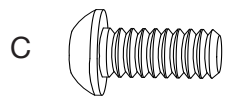
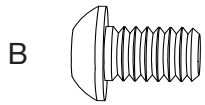
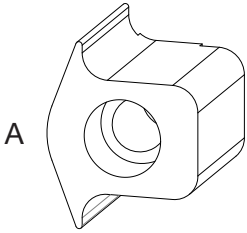

ID	PART #	DESCRIPTION
A	300-835x	Universal Shelf Peg
B	300-518x	1/4-20 x 3/8" Button Head Socket Screw
C	300-485x	1/4-20 x 1/2" Button Head Socket Screw
D	300-455x	1/4-20 x 1" Head Socket Cap Screw
E	300-465x	1/4-20 x 3/4" Head Socket Screw
F	302-315x	10-32 x 5/8" Flanged Button Head Socket Screw
G	300-468x	1/4" Flat Washer
H	300-532x	1/4-20 Lock Nut
I	300-565x	Drop In Nut
J	300-560x	1/4-20 Flat Nut
K	300-520x	1/4-20 Small Flat Nut
L	301-470x	5/16" Flat Washer

TOOLS INCLUDED

PART #	DESCRIPTION
P-400-030	Driver Bit 1/4" Hex Key
400-035	Leveler Wrench
400-030	1/4" Hex Key
400-080	5/32" Hex Key
400-058	3/16" Hex Key- Short Arm

TOOLS NEEDED

#2 Phillips Head Screw Driver
1/2 Drill Bit for Standard Installation
Pencil
Tape Measure
Level

WARNINGS

IMPORTANT SAFETY INSTRUCTIONS

READ ALL INSTRUCTIONS BEFORE USING THIS FURNISHING



WARNING! Failure to comply with these instructions may result in accident involving serious personal injury. Failing to follow these instructions can result in the product being damaged or being destroyed or voiding of the warranty.



CAUTION!

- Close supervision is necessary when this furnishing is used by or near children, invalids, or disabled persons
- Use this furnishing only for its intended use as described in these instructions. Do not use attachments not recommended by the manufacturer.
- Do not use outdoors
- For Commercial Use Only

***** **SAVE THESE INSTRUCTIONS** *****

Accessories and Spare Parts

Please contact Salamander Designs 860.761.9500 or www.salamanderdesigns.com/commercial

1. LEVEL CABINET



WARNING! This step requires two people.

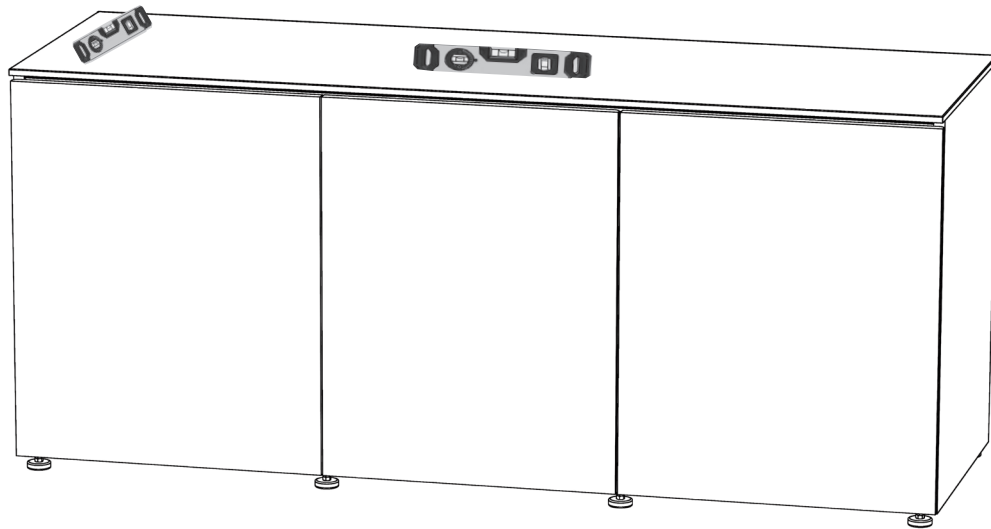

Leveler Foot

Loosen jam nut with supplied wrench and tighten to the locked position.

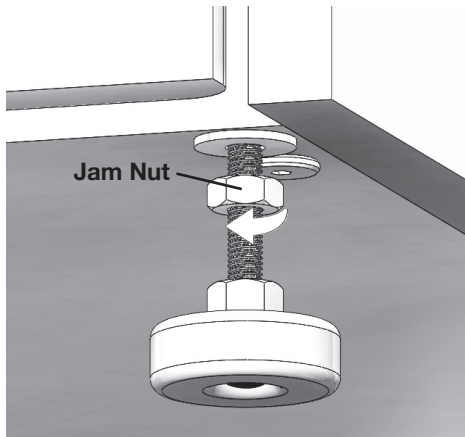

Wood Block Foot

Lift cabinet and adjust leveler by hand.

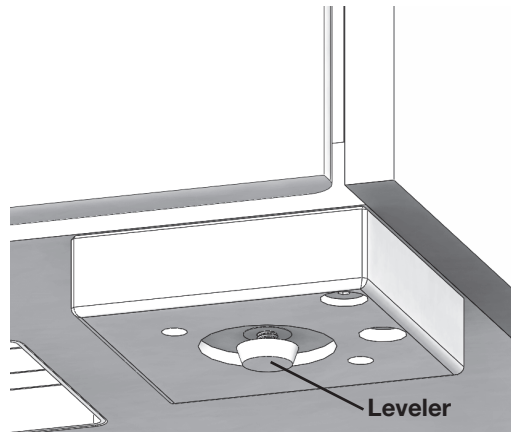

2. INSTALL SHELVES

NOTE: Shelf pegs can be re-positioned if desired.

A. Shelf placement can be adjusted if necessary to either predrilled locations or any location using Drop-In Nuts (I) Shelf Peg assembly (see diagram below).

B. Place shelves on pegs.

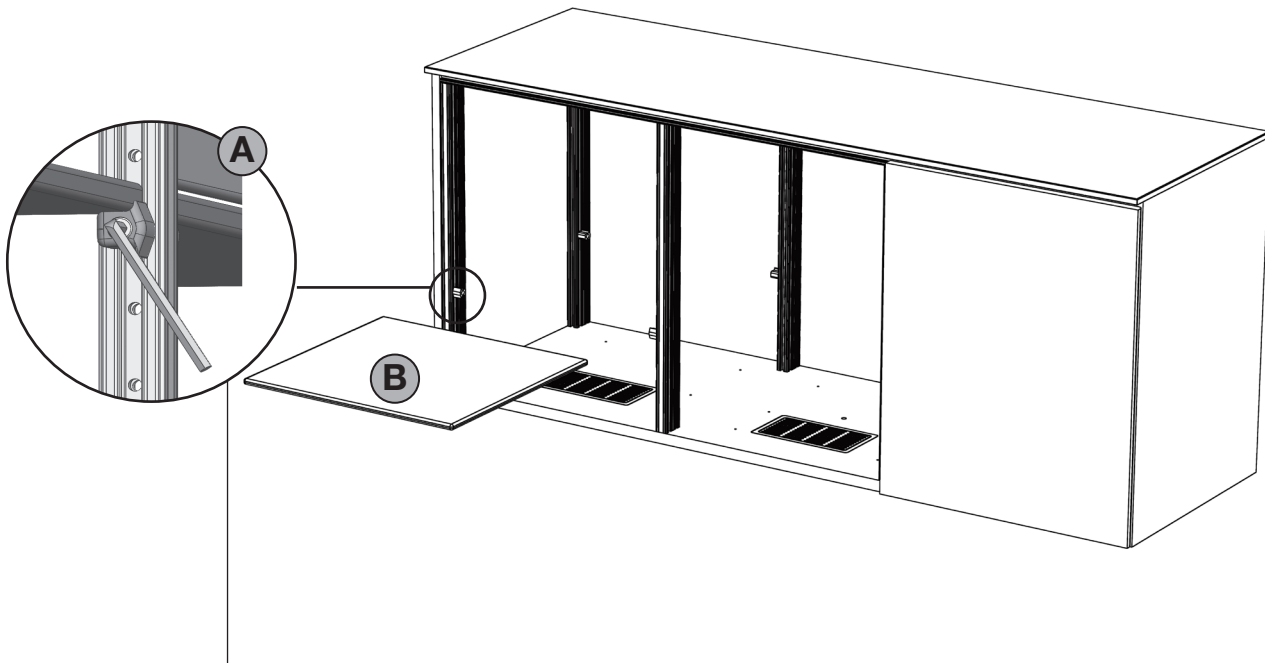

Drop-In Nut Option

Should you desire shelf placement in location other than predrilled locations, use the drop-in nut option. This option allows shelf to be placed at any height.

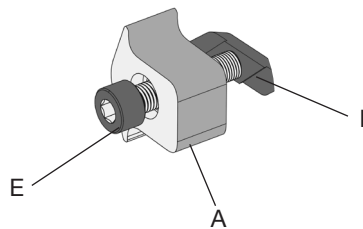

Assemble loosely as shown.

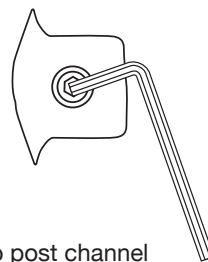

Insert into post channel and slide to desired height. Level shelf by adjusting shelf peg positions and tighten screw using hex key.

Note: Drop-in nut must make a 1/4 turn in post.

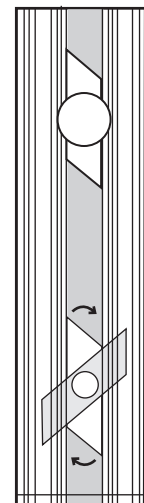

3. INSTALL REAR COOLING PANEL

A Attach Thermistor

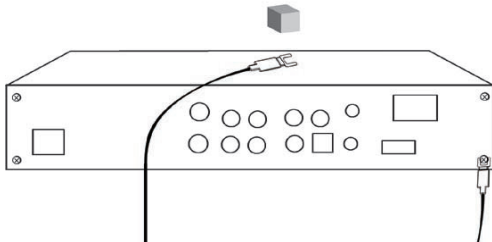

Use supplied magnetic cube to hold thermistor in place on top of the hottest piece of equipment closest to the heat source.

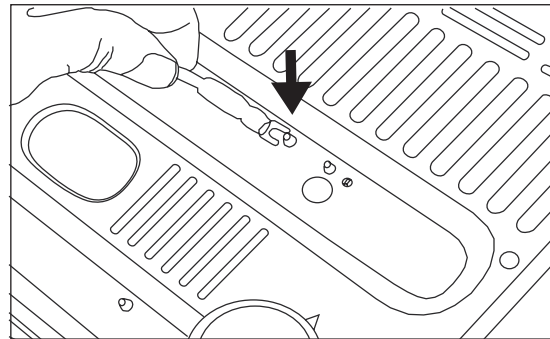

Alternative connection, connect the thermistor directly to the component. Loosen screw and slip the thermistor wire under the screw head and tighten.

B Plug in Power Supply

Plug in Ac adaptor bottom center behind fan grill.

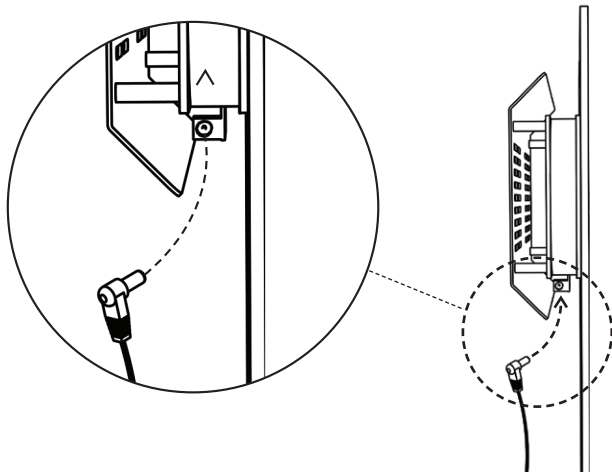

C Install Rear Cooling Panel

Squeeze in the provided handled slots and pull outward until panel is free.

NOTE: Reverse step for re-installation. Upon removal, carefully place rear panel in the up right position so not to damage the fan assembly.

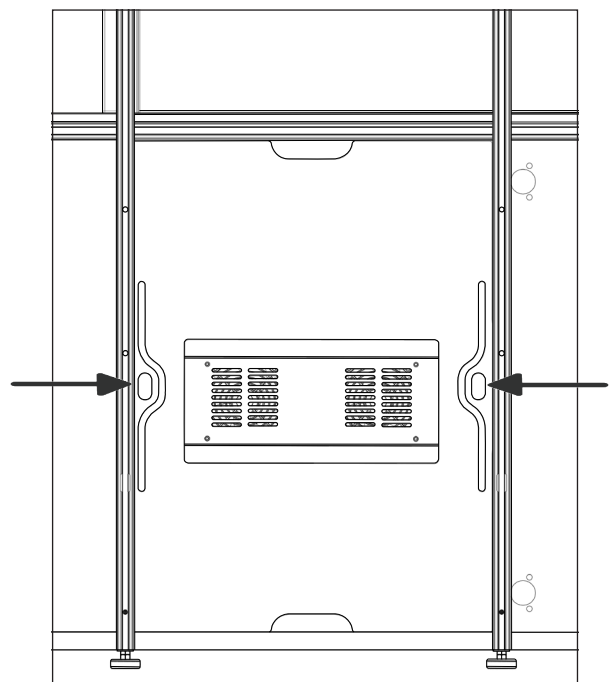

ADJUSTMENT TIPS

DOORS

NOTE: It is important that cabinet is level before adjusting doors, see step 1.

A **Main Adjustment (Side to Side and Up/Down)**
Adjustment is made by turning screw (A) in and out.

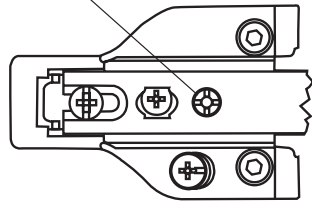

Adjust the tops of the doors to be parallel to the top of the cabinet.

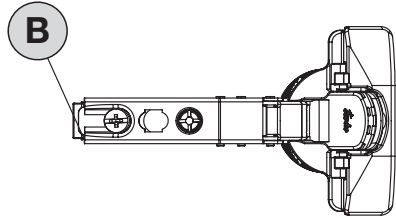
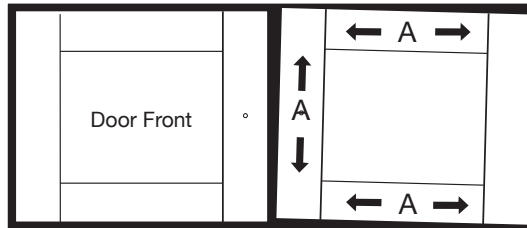

Dismount Hinge from Hinge Plate
With one hand holding the door open, pull back on the hinge quick-release lever (B).



**SALAMANDER
DESIGNS**

Furniture Shaped By Your Needs ®

LIMITED WARRANTY FOR COMMERCIAL VIDEO DISPLAY STANDS AND MOUNTS

Salamander is proud to stand behind our products with industry-leading warranties. Should you ever encounter any problem with your Salamander product, let us know. We are here to make it right. 1.860.761.9500

Full warranty including limitations and warranty claim information may be found at www.salamanderdesigns.com/commercial/warranty

Made in USA