

TAO 1pro

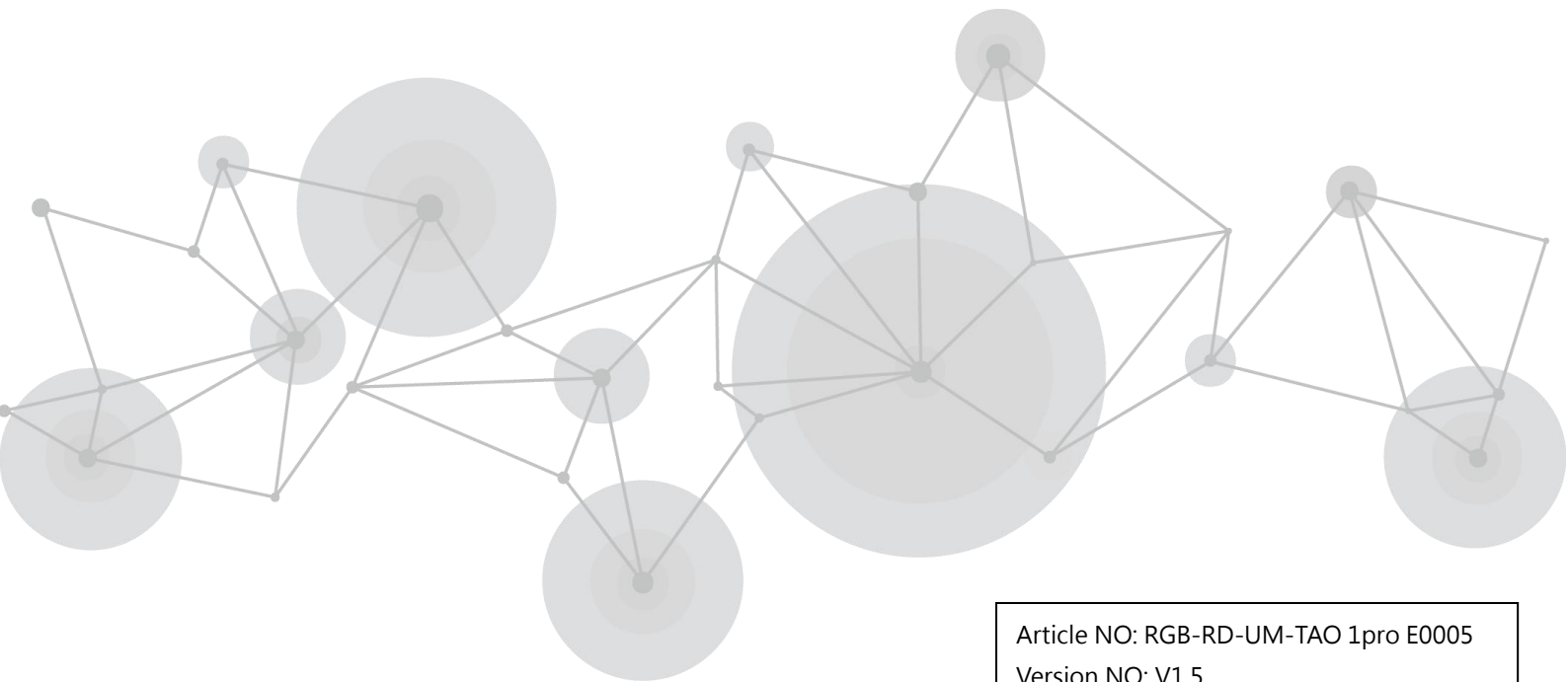

User Manual



Article NO: RGB-RD-UM-TAO 1pro E0005
Version NO: V1.5

Content

Declarations	3
FCC/Warranty	3
Operators Safety Summary	4
Installation Safety Summary	4
Chapter 1 Your Product	5
1.1 In the Box	5
1.2 Product Overview	6
1.2.1 Key Feature	6
1.2.2 Front Panel	7
1.2.3 Interface Panel	8
1.3 Dimension	9
Chapter 2 Install Your Product	10
2.1 Plug in Power	10
2.2 Connecting Input Signal	10
2.3 Connecting HDMI Output	11
2.4 Connecting Network	11
2.5 Connecting Microphone and External Monitor	11
2.6 Turn on TAO 1pro	12
Chapter 3 Use Your Product	13
3.1 Input/Output Area	13
3.1.1 Input Signal	13
3.1.2 How to Config TAO 1pro as a NDI Decoder	14
3.1.3 How to Config TAO 1pro as a Player	14
3.1.4 How to Config TAO 1pro to Stream	15
3.1.5 How to Config TAO 1pro as a NDI encoder	17
3.1.6 How to Config TAO 1pro as a Recorder	17
3.2 Scroll Area	18
3.2.1 Setting	18
3.2.2 Brightness	23
3.2.3 RGB Waveform	24
3.2.4 Vector	25
3.2.5 Histogram	25
3.2.6 Audio Meter	26
3.2.7 Viewfinder	26
3.3 Reminder Area	27
3.4 Status Display Area	28
Chapter 4 Upgrade	29
Chapter 5 Ordering Codes	32
5.1 Product Code	32

Chapter 6 Support	33
6.1 Contact us	33
Chapter 7 Appendix	34
7.1 Specification	34
7.2 Battery Installation	35
7.3 FAQ	37
7.4 Terms & Definitions	38
7.5 Revision History	45

Thank you for choosing our product!

This User Manual is designed to show you how to use this video processor quickly and make use of all the features. Please read all directions and instructions carefully before using this product.

Declarations

FCC/Warranty

Federal Communications Commission (FCC) Statement

This equipment has been tested and found to comply with the limits for a class A digital device, pursuant to Part 15 of the FCC rules. These limits are designed to provide reasonable protection against harmful interference when the equipment is operated in a commercial environment. This equipment generates, uses, and can radiate radio frequency energy and, if not installed and used in accordance with the instruction manual, may cause harmful interference to radio communications. Operation of this equipment in a residential area may cause harmful interference, in which case the user will be responsible for correcting any interference.

Guarantee and Compensation

RGBlink provides a guarantee relating to perfect manufacturing as part of the legally stipulated terms of guarantee. On receipt, the purchaser must immediately inspect all delivered goods for damage incurred during transport, as well as for material and manufacturing faults. RGBlink must be informed immediately in writing of any complains.

The period of guarantee begins on the date of transfer of risks, in the case of special systems and software on the date of commissioning, at latest 30 days after the transfer of risks. In the event of justified notice of compliant, RGBlink can repair the fault or provide a replacement at its own discretion within an appropriate period. If this measure proves to be impossible or unsuccessful, the purchaser can demand a reduction in the purchase price or cancellation of the contract. All other claims, in particular those relating to compensation for direct or indirect damage, and also damage attributed to the operation of software as well as to other service provided by RGBlink, being a component of the system or independent service, will be deemed invalid provided the damage is not proven to be attributed to the absence of properties guaranteed in writing or due to the intent or gross negligence or part of RGBlink.

If the purchaser or a third party carries out modifications or repairs on goods delivered by RGBlink, or if the goods are handled incorrectly, in particular if the systems are commissioned operated incorrectly or if, after the transfer of risks, the goods are subject to influences not agreed upon in the contract, all guarantee claims of the purchaser will be rendered invalid. Not included in the guarantee coverage are system failures which are attributed to programs or special electronic circuitry provided by the purchaser, e.g. interfaces. Normal wear as well as normal maintenance are not subject to the guarantee provided by RGBlink either.

The environmental conditions as well as the servicing and maintenance regulations specified in this manual must be complied with by the customer.

Operators Safety Summary

The general safety information in this summary is for operating personnel.

Do Not Remove Covers or Panels

There are no user-serviceable parts within the unit. Removal of the top cover will expose dangerous voltages. To avoid personal injury, do not remove the top cover. Do not operate the unit without the cover installed.

Power Source

This product is intended to operate from a power source that will not apply more than 230 volts rms between the supply conductors or between both supply conductor and ground. A protective ground connection by way of grounding conductor in the power cord is essential for safe operation.

Do Not Operate in Explosive Atmospheres

To avoid explosion, do not operate this product in an explosive atmosphere.

Installation Safety Summary

Safety Precautions

For all product installation procedures, please observe the following important safety and handling rules to avoid damage to yourself and the equipment.

To protect users from electric shock, ensure that the chassis connects to earth via the ground wire provided in the AC power Cord.

The AC Socket-outlet should be installed near the equipment and be easily accessible.

Unpacking and Inspection

Before opening product shipping box, inspect it for damage. If you find any damage, notify the shipping carrier immediately for all claims adjustments. As you open the box, compare its contents against the packing slip. If you find any shortages, contact your sales representative.

Once you have removed all the components from their packaging and checked that all the listed components are present, visually inspect the system to ensure there was no damage during shipping. If there is damage, notify the shipping carrier immediately for all claims adjustments.

Site Preparation

The environment in which you install your product should be clean, properly lit, free from static, and have adequate power, ventilation, and space for all components.

Chapter 1 Your Product

1.1 In the Box

Power Adapter



Type-C Power Cord



Doublethread

1/4 Screw



Note:The color of the accessories is subject to actual conditions

1.2 Product Overview

TAO 1pro is a Broadcasting streaming decoder with a 5.5 inch FHD preview display, but also a 4 channels seamless video switcher for 2 USB 3.0 and 2 HDMI 1.3 inputs, and supports streaming directly by ethernet output which is ready to connect to external cloud based router and streaming from Anywhere to Everywhere.

TAO 1pro is compatible with standard USB 2.0 and USB 3.0 cameras by UVC protocol, and brings itself as a much affordable and user friendly streaming tools for anybody, the talents who is willing to be Anchor Online.

TAO 1pro is also with touch panel for finger configuration, and with optional 2 chargeable battery extending its capacity for outdoor application.

TAO 1pro is a multiple function unit, can be configured as Switcher, Monitor, Recorder, Encoder and Converter.

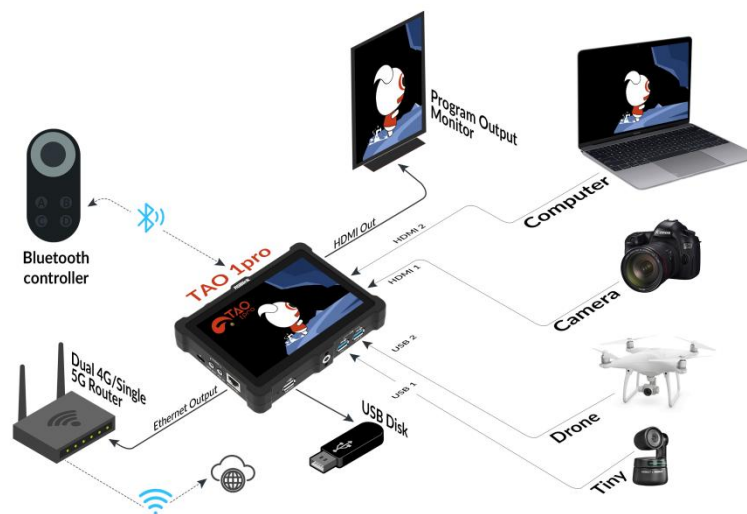

SYSTEM CONNECTION

1.2.1 Key Feature

- 5.5 inch HD touch screen for operation
- Network HD streaming, H.264 encoding
- Asynchronous rotation of main screen and HDMI output
- 2*UVC inputs, 2*HDMI 1.3 input and 1* HDMI 2.0 output
- HDCP supported
- Bluetooth 5.0
- NDI 5.0 encoder
- Broadcasting Monitor with waveform, vector and histogram analyse build in
- Recorder to USB 2.0 SSD hard disk, range up to 2TB
- Multistream up to 4 Live Streaming platform Simultaneously
- External power by Type C with PD3.0 protocol compliance or optional external battery up to two batteries

1.2.2 Front Panel

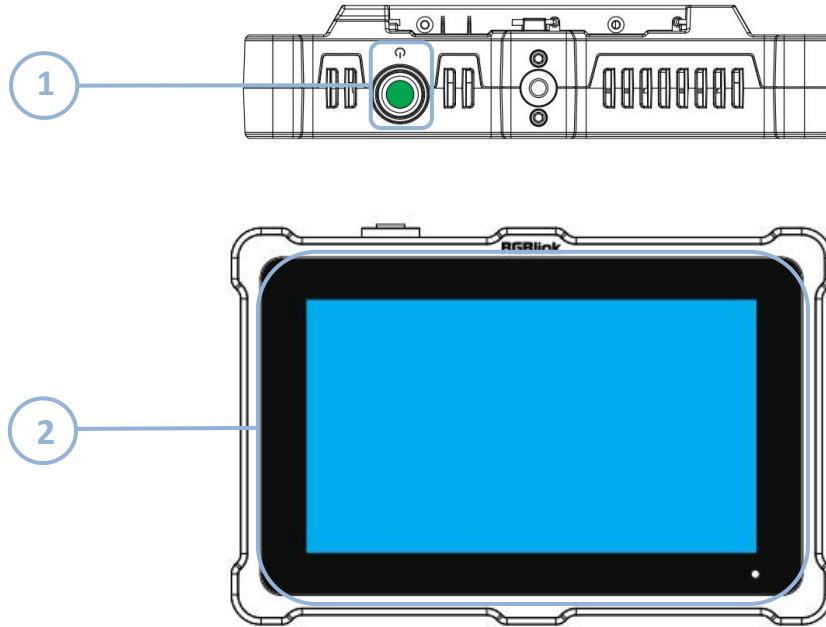

No.	Item	Description
1	Power Button	Gently press to turn on, long press 3 seconds to turn off
2	Touch Screen	5.5 inch touch screen for menu control

1.2.3 Interface Panel

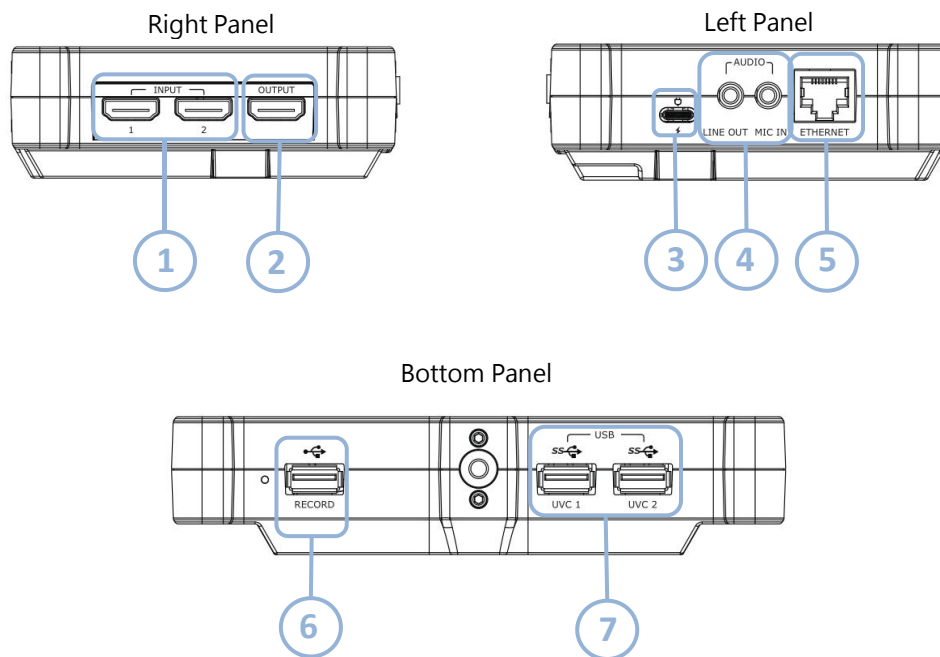

No.	Connectors	Number	Description
1	HDMI IN	2×HDMI IN	Connect to camera and computer
2	HDMI OUT	1×HDMI OUT	Connect to external monitor
3	Type C	1×PD Type C	Connect to the power supply
4	Audio	1×MIC IN/LINE OUT	Connect to microphone and earphone
5	LAN	1×RJ45	Gigabit network port
6	USB 2.0	1×USB Type A	Connect to hard disk for recording, and storage up to 2T
7	USB 3.0	2×USB Type A	Connect to USB camera for UVC capture

1.3 Dimension

Following is the dimension of TAO 1pro for your reference:

160.92mm×106mm×36mm

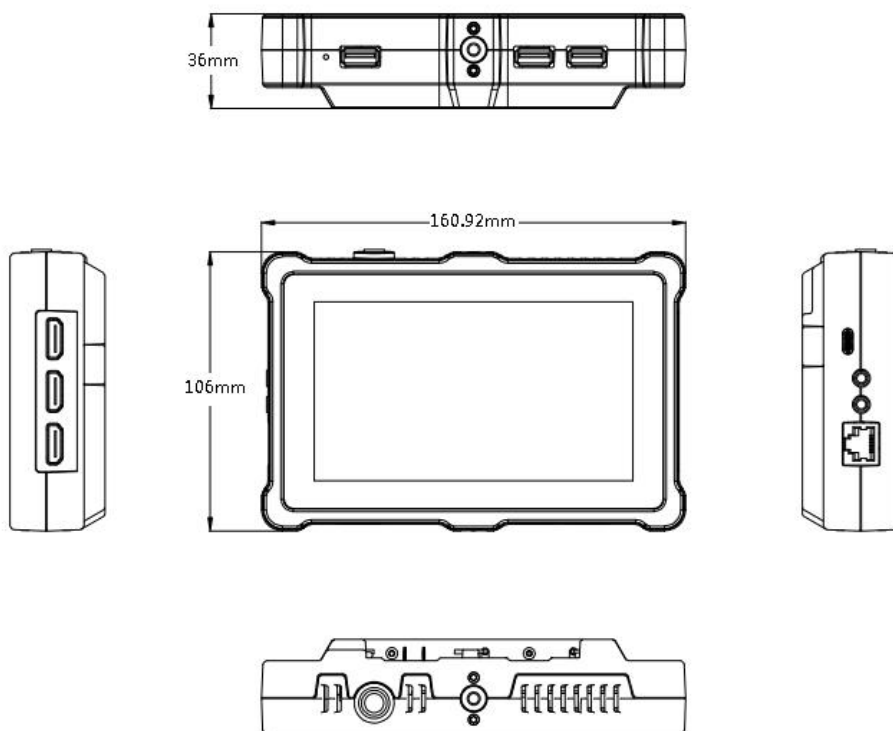

Chapter 2 Install Your Product

2.1 Plug in Power

RGBlink TAO 1pro is packaged with a Type C power link cable and a standard power adapter. When connect the power supply, please check the power supply standard used in your country/area.

Besides,TAO 1pro also supports power supply via batteries.(Battery options in <7.2> for your reference)



2.2 Connecting Input Signal

The camera or device with UVC compliance can be input signal to TAO 1pro by USB 3.0 interface.The camera or device with HDMI 1.3 compliance can be input signal to TAO 1pro by HDMI interface.You can see the resolution of the input signal on the 5.5 inch touch screen when there is active signal plug in.



Recommend:

TAO 1pro is compliance to 1080p50/60 device, once the input signal is interlace or other standard, it is no recommend.

And it is recommended to connect the input sources firstly and then power on TAO 1pro after.

Once user change the input signal standard or re-connect the input signal cables, it is strongly recommended to power off and on TAO 1pro to make sure its signal capture correctly.



2.3 Connecting HDMI Output

You can use an HDMI cable to connect the HDMI output to a monitor with an HDMI input interface, so that you can monitor the input, output and audio display in real time.



Recommend:

External HDMI 1.3 full HD monitor is recommended.

For external HDMI 2.0 monitor, only once TAO 1pro is used as an converter.



2.4 Connecting Network

On the left panel of TAO 1pro, there is a LAN port which can be connected to the router via CAT5e/CAT6 cable or connected wirelessly via SIM card for live streaming. (Details refers to <3.4 Streaming>)



2.5 Connecting Microphone and External Monitor

On the left panel of TAO 1pro, there is two 3.5mm standard interface which can be directly connected to the microphone. You can also use external speakers or headphones to monitor the main output audio signal in real time. Audio supports 0~60db.



2.6 Turn on TAO 1pro

After TAO 1pro is connected to power supply, gently press the Power button on the top panel, the device will enter to the boot interface and enter operation interface.



Chapter 3 Use Your Product

Once push the power button to power on TAO 1pro, the 5.5 inch display will show TAO logo and then come into the main menu, and once the default input signal is connected, operator can follow the following operations to use TAO 1pro. The main menu of TAO 1pro can be divided into four parts: Input/Output Area, Scroll Area, Reminder Area and Status Display Area.

3.1 Input/Output Area

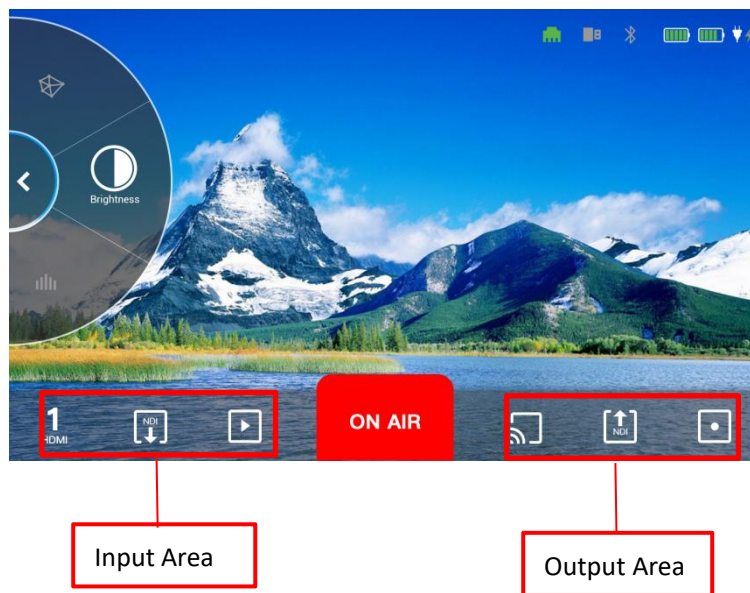

3.1.1 Input Signal

Long press to enter [Signal Source] Interface so as to choose/switch input signal. HDMI/UVC for you to choose from.



- 1. Source Status: ○--No Source; ○--Ready; ○--Selected.
- 2. Only by switching to the UVC signal can the control be achieved. Grey status of UVC signal indicates unavailable status.

3.1.2 How to Config TAO 1pro as a NDI Decoder

If you need to operate NDI decoding mode, you need to set the IP address (same as the network of camera), subnet mask and gateway in [Network Settings] of [Scroll Area] first. Then long press the icon to enter the following interface, turn on the switch to start NDI decoding function.



Resolution: up to 1920x1080@60

Bitrate: 41000HZ

NDI Type: show NDI type

OFF/ON: turn on/off NDI decoding mode

Note: Please refer to [3.2.1.2 Network](#) for operations of setting IP address,subnet mask and gateway.

3.1.3 How to Config TAO 1pro as a Player

You can insert a USB flash drive into the USB 2.0 port and then play the video in the USB. Long press the icon to enter the [Player] interface and select the video you want to play.



Note: If there is no USB flash drive inserted, the icon displays gray status.

3.1.4 How to Config TAO 1pro to Stream

Following steps take YouTube stream as example:



Step 1: Make sure TAO 1pro connect to the network.

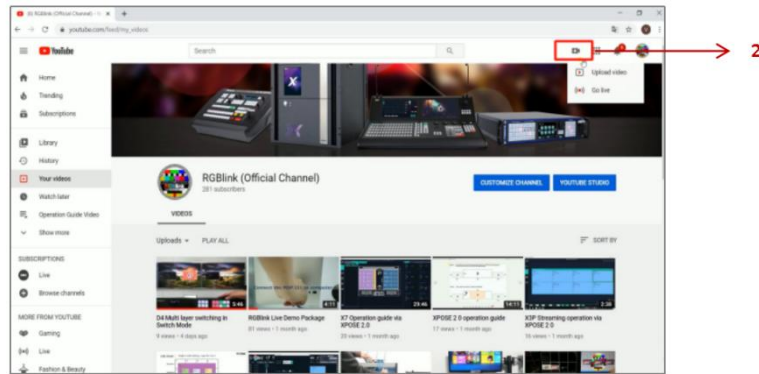

Step 2: Open YouTube Studio on your computer,select 【Go Live】 -- 【Stream】 ,Copy Stream URL and Stream Key.

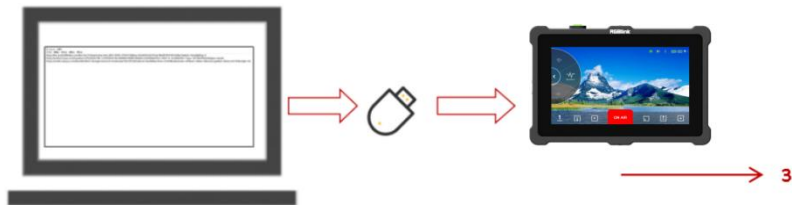

Step 3: Create a new TXT file first,and paste the Streaming URL and Stream Key (the format must be : rtmp//:YOUR STREAM URL/YOUR STREAM KEY), and save the TXT file to USB as rtmp.ini.(Newline is required to add multiple streaming addresses) and connect the USB disk to TAO 1pro's RECORD USB port.

If you finish the above steps, then click [Stream Output] icon to enter the following interface.

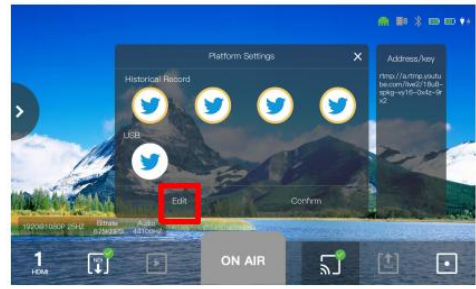

Historical Record: You can directly find the address you have saved in the [Historical Record] . You can also delete specific platforms by clicking [Edit]

USB: The recognized address of streaming platform stored in USB flash drive

Address/key: Show the stream URL and KEY

Confirm: Click to confirm the selected streaming platform

Then clicking [Confirm] to enter the [Stream Output Config] interface, as shown below.

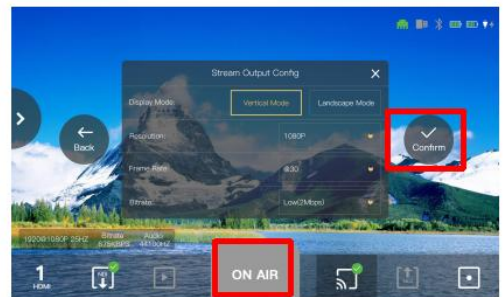
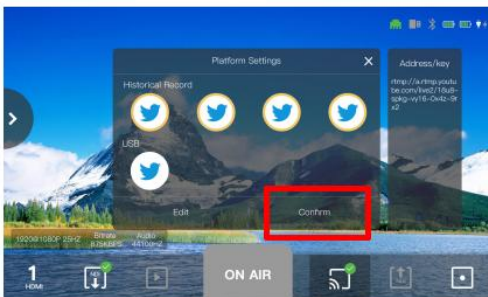

Display Mode: Including Landscape Mode and Vertical Mode

Resolution/Frame Rate/Bitrate: Support settings of resolution/frame rate/bitrate

Back: Return to the previous page

Confirm: Click to confirm the previous settings

After completing the above steps, click [ON AIR] to stream (support up to 4 live streaming platforms at the same time).



Source Status: ○ --Available but Failed in Streaming; ○ --Streaming.

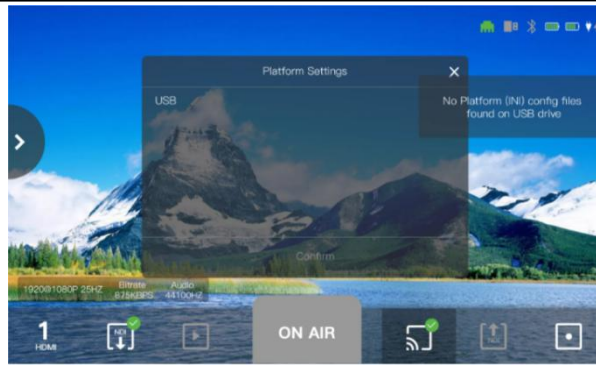

Note: If no files can be identified in USB, the interface will show the above prompt.

3.1.5 How to Config TAO 1pro as a NDI encoder

TAO 1pro supports NDI 5.0 decoding and transmit data in H.264/H.265/RGBA/YUV442 format. In NDI network, TAO 1pro can convert video data from other channels (such as IP video streaming, HDMI, etc.) into NDI format and send it to the receiver.

Press the NDI decoding icon to enter the interface.

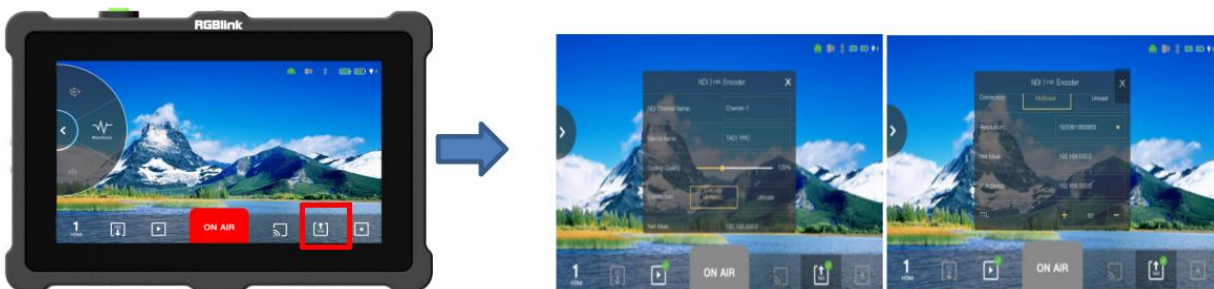

NDI Channel Name: Edit the name of NDI channel

Device Name: Edit the name of device

Coding Quality: Adjust compression ratio of NDI coding

Connection: Multicast/Unicast optional

If you select Multicast, you can also set **Net Mask/ IP Address/TTL**. After setting, click [Save].

3.1.6 How to Config TAO 1pro as a Recorder

Plug USB hard drive to TAO 1pro USB 2.0 port and then TAO 1pro can work as a recorder. Click record icon to start recording.

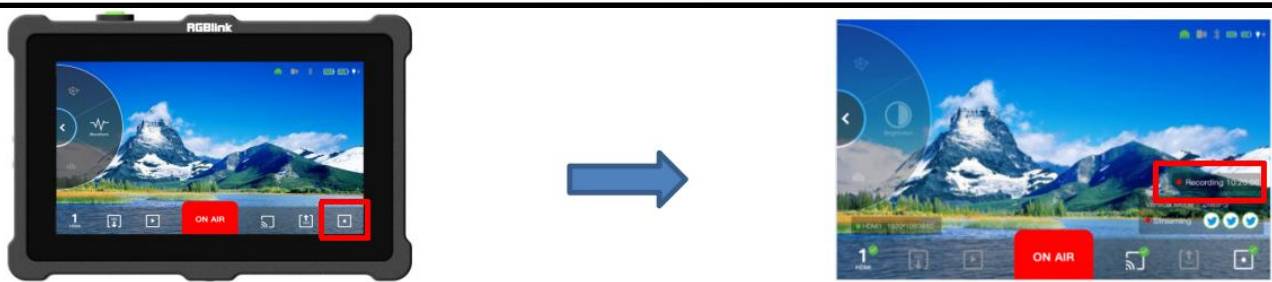

Note: If there is no USB flash drive inserted, the recording icon displays gray status.

3.2 Scroll Area

The left area of the interface is the scroll area, where users can scroll clockwise/counterclockwise to achieve functions such as Setting, Audio Meter, Brightness, RGB waveform, Vector, Histogram, and Viewfinder.

3.2.1 Setting

Click [Setting] to enter following interface.



3.2.1.1 Input Settings

Click [Input] to enter [Input Settings] page.



In this interface, you can set the **Input Signal**, **Input Format**, **Audio Sampling Rate**, **Signal Name**, **Brightness**, **Contrast**, **Saturation**, **Hue** and **Sharpness**.

3.2.1.2 Network

Click [Network] to enter the following page. When HDCP is turned off, you can manually set the IP Address, Netmask and Gateway in the menu; When HDCP is turned on, the IP Address can be captured automatically. After setting, click [Save].

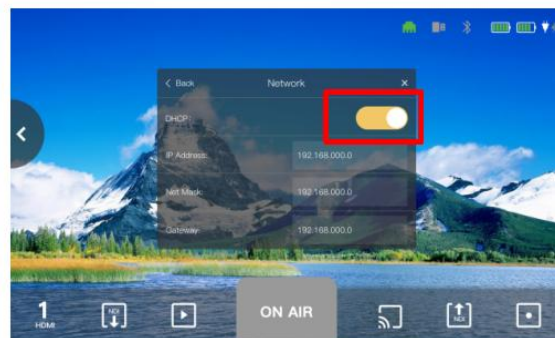
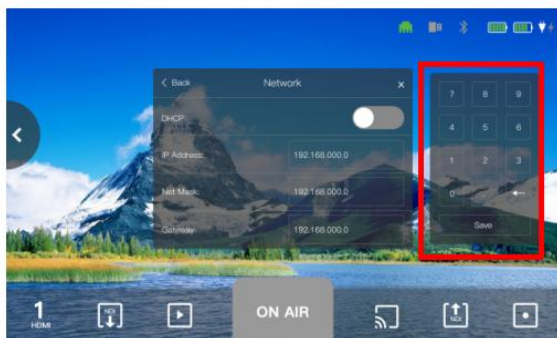

3.2.1.3 Bluetooth

You can connect the Bluetooth controller to control PTZ camera.(only RGBlink PTZ)



Turn ON Bluetooth and choose the device to be connected to achieve control of PTZ camera.

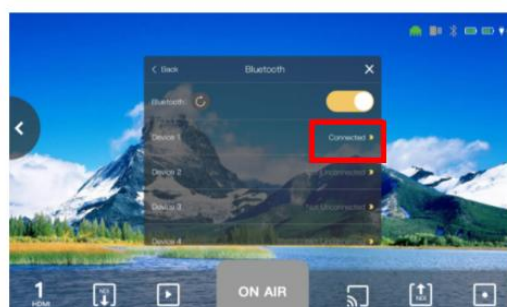
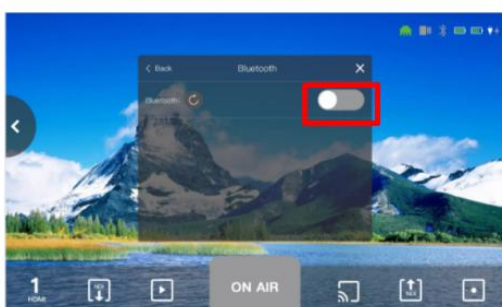

3.2.1.4 UVC Control

When there are PTZ cameras connected to TAO 1pro,you can control PTZ in the menu. Click [UVC Control] to enter the following page.



In the [UVC Control] menu,there are six Views to be selected. After selecting the View, you should first click [Save] and then [Load] If you would like to change the default setting, then click [View 1] and adjust the location and zoom manually or you can turn on [Auto].

3.2.1.5 Fan Control

Click [Fan Control] to enter the following page.

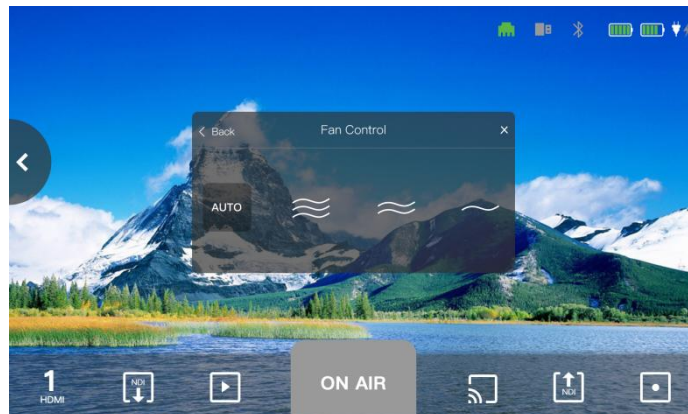

In the fan control interface, you can set the fan speed. Three fan speeds for you to choose from, and you can also choose to turn on [Auto] to achieve automatic adjustment of the speed.

3.2.1.6 Stream Output

Click [Stream Output] to enter the setting page. For more details, please refer to **3.1.4 How to config TAO 1pro to Stream.**

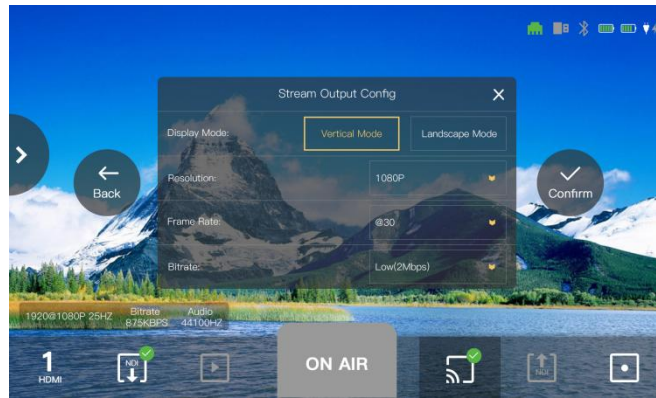

3.2.1.7 NDI Decoder

Click [NDI Decoder] to enter the setting page. For more details, please refer to **3.1.2 How to config TAO 1pro as a NDI Decoder.**

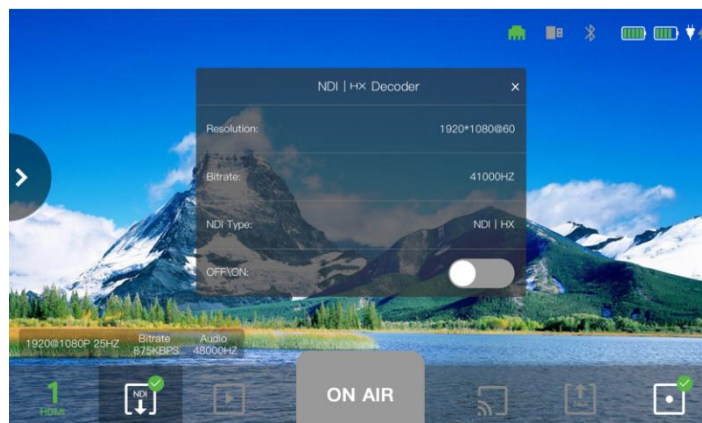

3.2.1.8 NDI Encoder

Click [NDI Encoder] to enter the setting page. For more details, please refer to **3.1.5 How to config TAO 1pro as a NDI Encoder.**

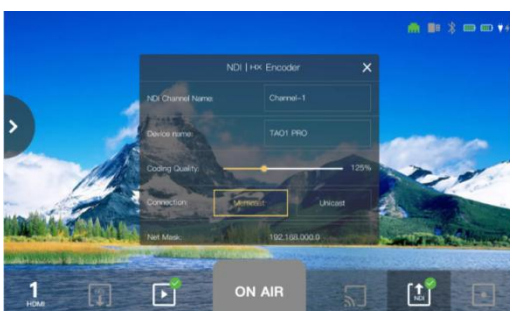

3.2.1.9 Display

Click [Display] to enter the setting page. In this interface, you can set the brightness of the output, HDMI output resolution. In addition, TAO 1pro also comes with a screen rotation function.

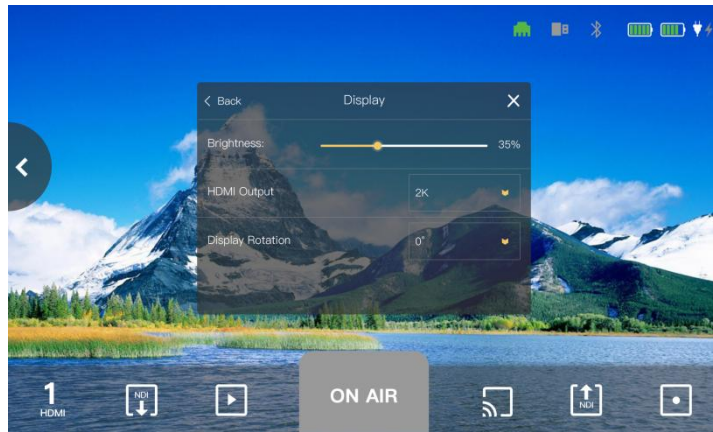

Brightness: 0-100%

HDMI Output: 2K, 4K

Display Rotation: 0° , 180°

3.2.1.10 About

Click [About] to enter the following interface.

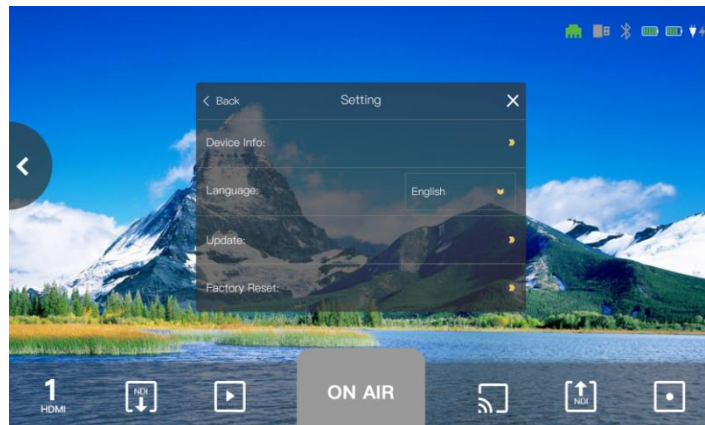

Device Info: Include info of device name, serial number, software version and hardware version

Language: English and Chinese optional

Update: for update guideline, please refer to Chapter 4 for more detailed operation.

Factory Reset: A message will appear to remind you of your factory reset operation. If you confirm the reset, click [YES], otherwise, click [NO].

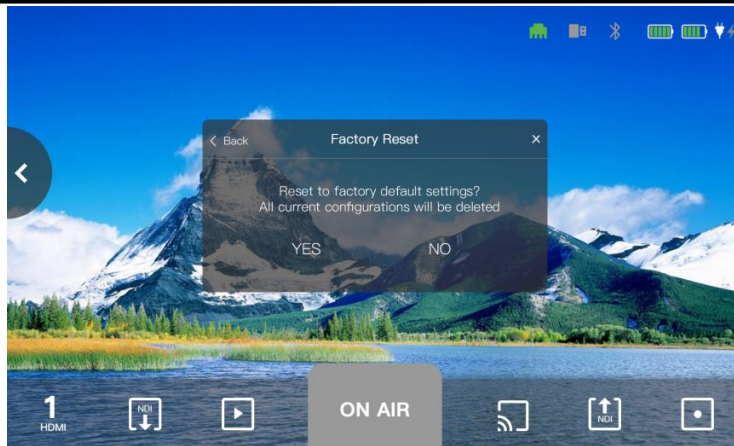

3.2.2 Brightness

Click [Brightness] to select position and transparency.

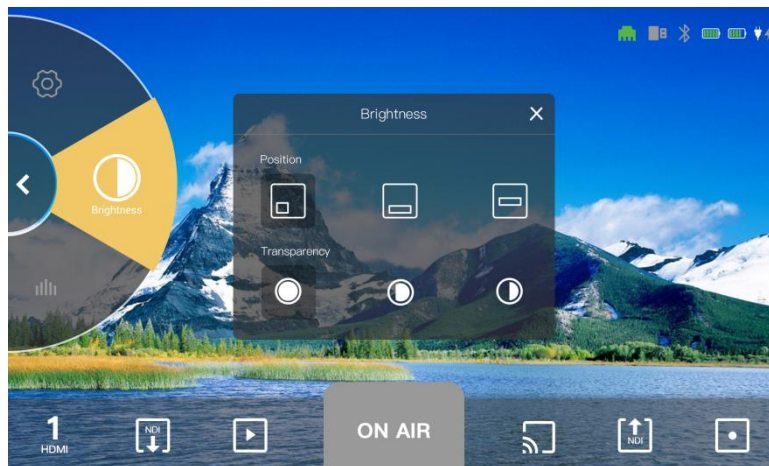

As shown in the picture above, the top side of Brightness means the brightest, the bottom means the darkest. As we can see, the wave is close to the top side, which means the picture now is bright.

3.2.3 RGB Waveform

Click [RGB Waveform] to select position and transparency.

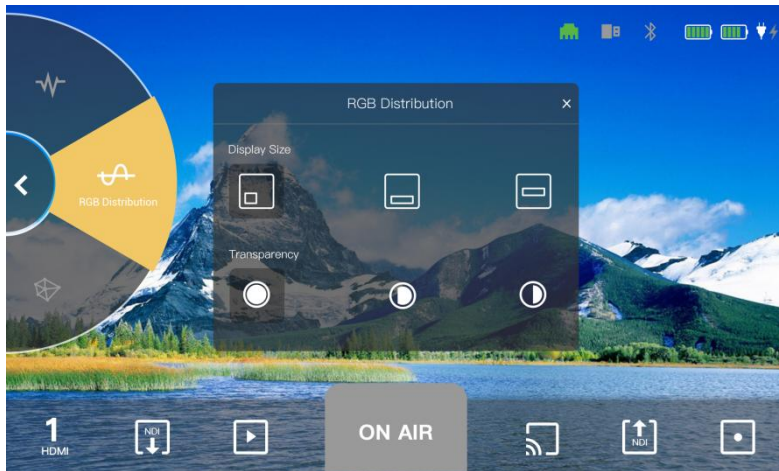

As shown in the picture below, users can see the component of red, green and blue through RGB Waveform. When shooting a white object with a camera, and the wave level of red, green and blue are consistent, which means that the white balance is set correctly. So RGB Waveform is used to detect white balance.

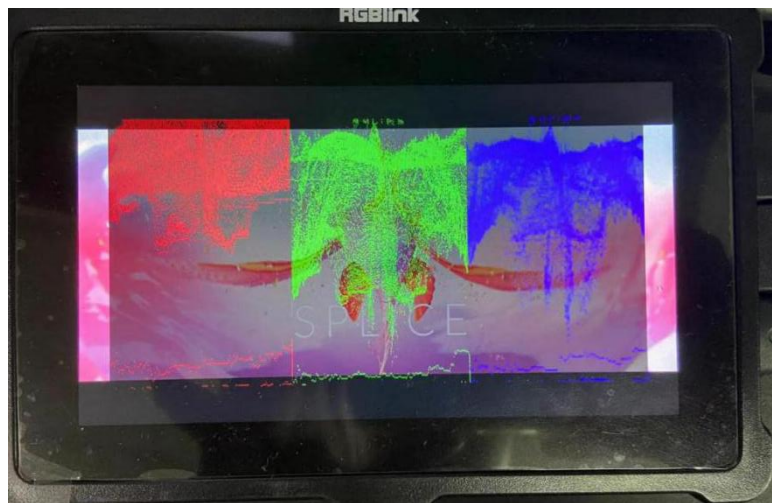

3.2.4 Vector

Click [Vector] to select position and transparency.

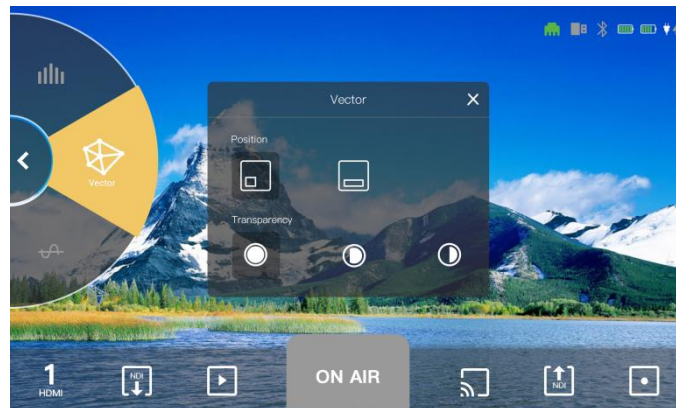

Vector shows color information of hue, vector and color intensity. By means of Vector, You can identify the low saturation area and color balance. As shown in the picture below,there are six letters,which means: Red, Magenta, Blue,Cyan,Green and Yellow. Through the Vector, we can easily see that the picture color are mostly yellow and cyan.



3.2.5 Histogram

Click [Histogram] to select position and transparency.

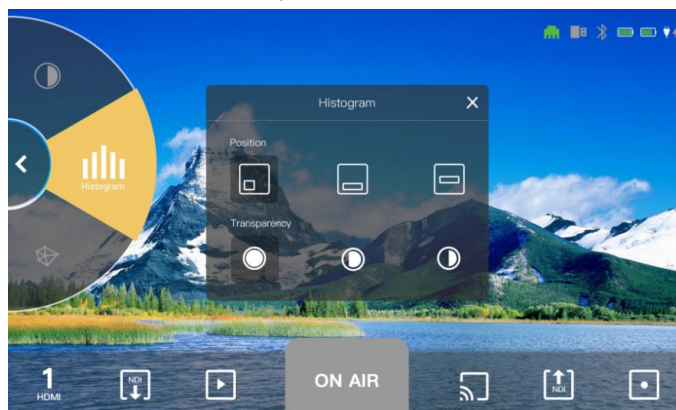

As shown in the picture below, the left side of the histogram means dark, right side means bright. As we can see, the R G B color are close to the left side, which means the picture is mostly dark. It is helpful to monitor the brightness and set a correct exposure when shooting.



3.2.6 Audio Meter

Gently touch audio column in the left to open [Audio Meter] menu.

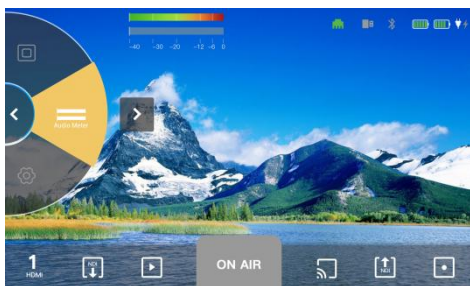

As shown in the pictures above, there are six audio columns in the interface, two HDMI 2.0 input audios, two UVC input audios, one 3.5 mm analog audio input and one 3.5mm analog audio output. Every audio column is divided into left/right channel.

You can select **【Auto】** or manually turn on the column by touch the rectangle icon above the column. (Yellow icon indicates selected one)

3.2.7 Viewfinder

Click [Viewfinder] to select frame size (16:9 or 4:3). Users can cut out the screen outside the frame based on the actual size.

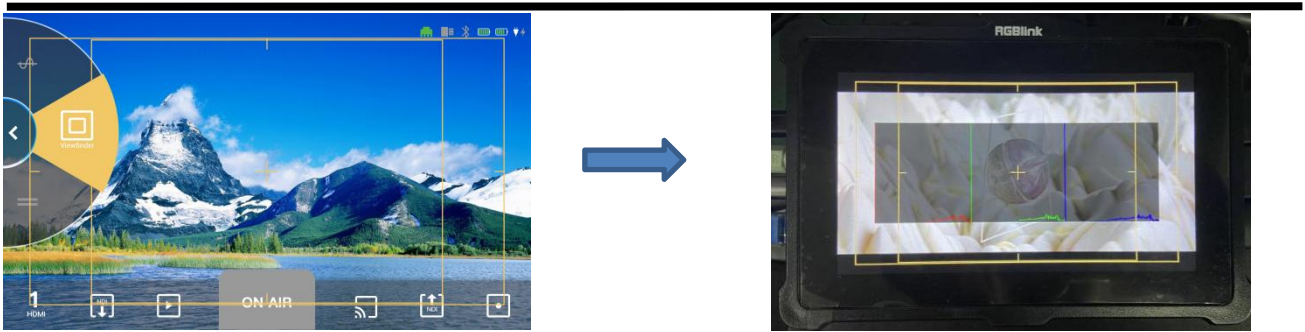

3.3 Reminder Area

TAO 1pro also comes with [Reminder Area] as shown.

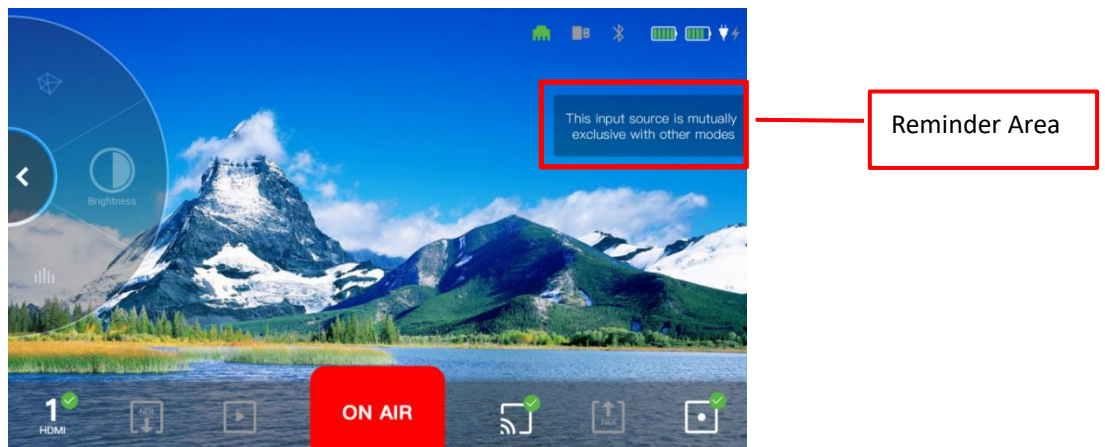









The above message shown in the Reminder Area means exclusive use of several modes.

 The following table concludes the mutual exclusion of TAO 1pro.

	Recorder	Waveform	Stream	NDI Encoder	NDI Decoder	Player
Recorder	✓	✗	✗	✗	✓	✗
Waveform	✗	✓	✗	✗	✓	✗
Stream	✗	✗	✓	✗	✓	✓
NDI Encoder	✗	✗	✗	✓	✗	✓
NDI Decoder	✓	✗	✓	✗	✓	✓
Player	✗	✗	✓	✓	✓	

3.4 Status Display Area

The upper right of interface is the Status Display Area, which displays the status of the TAO 1pro.

	no network input		no USB		Bluetooth is not connected.		not plugged in
	with network input		with USB		Bluetooth is connected.		plugged in
	Power display of two batteries						

Chapter 4 Upgrade

Tool: USB disk(copy the firmware to the root directory of USB disk)

Approaches for upgrade guideline:

1) Website (decompression required)

CN: <https://www.rgblink.cn/productsinfo.aspx?id=157>

EN: <https://www.rgblink.com/productsinfo.aspx?id=204>

2) Dropbox (without decompression)

<https://www.dropbox.com/sh/akcgjcqcsbn8b8q/AAAhYUsU4qVS9P7aD2-qmB46a?dl=0>

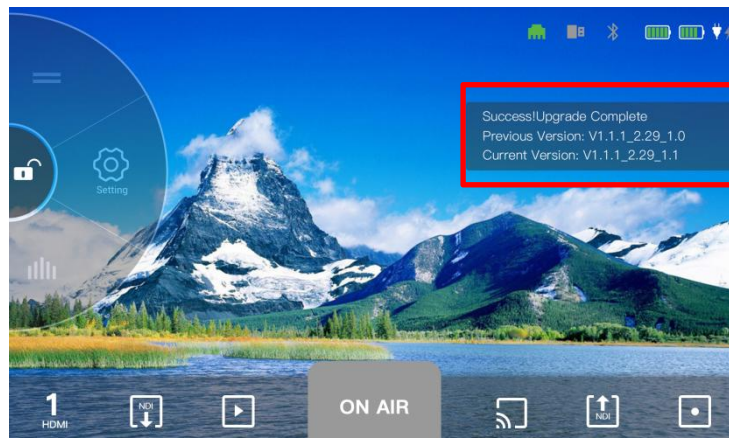

Remark:

1. The U disk format supports FAT32, NTFS, exFAT and other formats. Please do not decompress and rename the delivered package to avoid being unable to upgrade.
2. Do not power off during the upgrade process, otherwise it is easy to cause the system to be unable to enter the system after booting.
3. If an old program (before V1.2.26), there will be a gray screen for about 1 minute when upgrade(the program is decompressed and loaded).
4. If your version is V1.2.47_3.68_2.13and before,please add firmware upgrades for HDMI input first. Do not connect any signal to the HDMI input port during upgrading. After the software package upgrade is complete, the device will automatically restart and perform firmware upgrade for HDMI input. Waiting for a moment ,a message indicating that the upgrade is successful will pop up in the upper right corner, then need to restart the device manually.



Upgrade Steps:

1. Support img format package upgrade. Copy the file to the root directory of the U disk (the img package will be upgraded synchronously)

-  TAO1PRO RELEASE V1.2.28 3.54 2.8 patch 202202081800.zip
-  TAO1PRO RELEASE V1.3.09 3.77 2.14 202204291545.img
-  TAO1PRO RELEASE V1.3.07 3.77 2.14 PATCH.zip

Note: After upgrading the img format package, the ZIP format package upgrade is no longer supported

2. Insert the U disk into the record USB port. Power on TAO 1pro.



3. Enter system setting and select the [Upgrade] option.

1) Upgrade the V1.2.28 first. The new UI change a lot and need to upgrade it first then go on the new version.

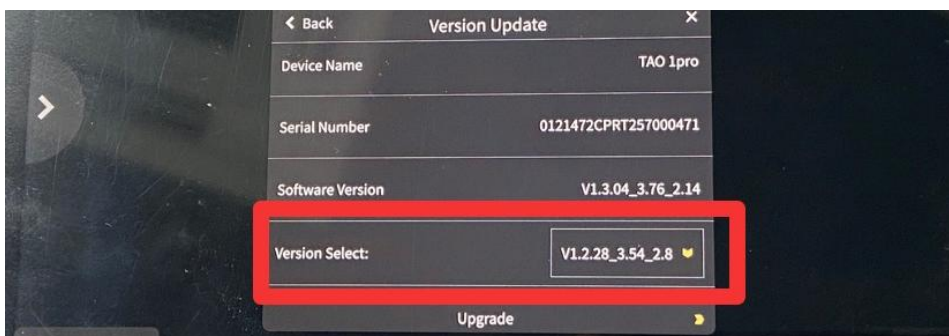

Then wait for a moment ,shows “In upgrading progress...” and the TAO 1pro will restart automatically.

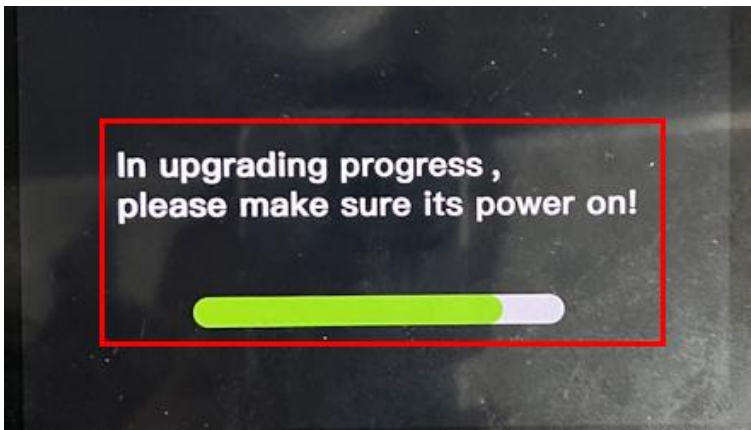

2) After finishing the V1.28 upgrade, then choose V1.3.07, and do the upgrade operation again.

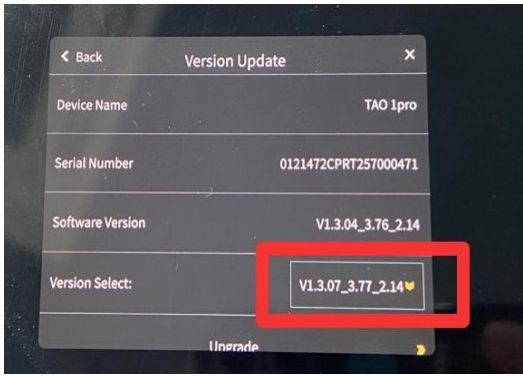
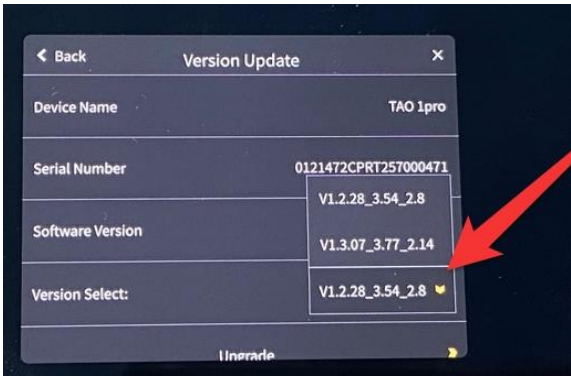

Then wait for about 5 minutes (do not power off during upgrade). And the TAO 1pro will upgrade the img package synchronously, no need of any other operation during this process.

4. When the upgrade is done, check the version in the menu, if the version shows the same as the picture (V1.3.09_3.77_2.14), the upgrade is successful. If it is inconsistent with the displayed version, it means the upgrade failed, please try to upgrade again.

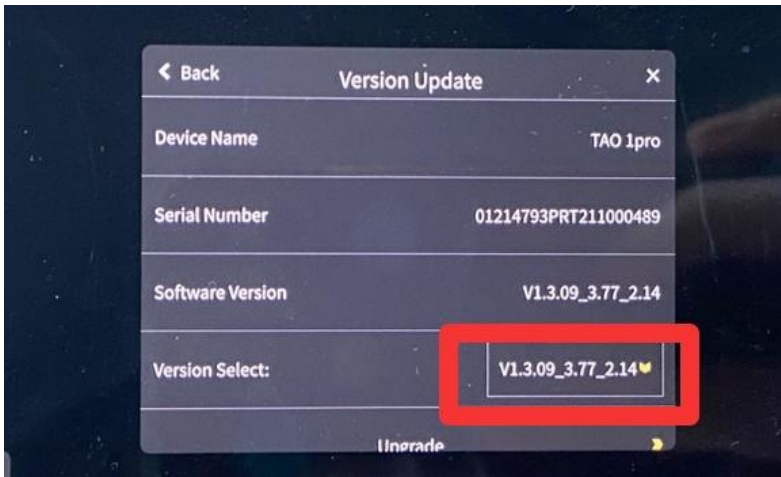

Chapter 5 Ordering Codes

5.1 Product Code

410-5513-01-0

TAO 1pro

Chapter 6 Support

6.1 Contact us

www.rgblink.com



Inquiries

+86-592-577-1197
info@rgblink.com
rgblink.com/contact-us

Global Support

support@rgblink.com
rgblink.com/support-me



@RGLINK



/rgblink



+rgblink



/rgblink



rgblink



rgblink

RGBlink Headquarters

Xiamen, China

Room 601A, No. 37-3
Banshang community,
Building 3, Xinke Plaza, Torch
Hi-Tech Industrial
Development Zone, Xiamen,
China

+86-592-577-1197

China Regional Sales & Support

Shenzhen, China

11th Floor Baiwang Building
5318 Shahe West Road
Baimang, Nanshan

+86-755 2153 5149

Beijing Region Office

Beijing, China

Building 8, 25 Qixiao Road
Shahé Town Changping

+010- 8577 7286

Europe Regional Sales & Support

Eindhoven, Holland

Flight Forum Eindhoven
5657 DW

+31 (040) 202 71 83

Chapter 7 Appendix

7.1 Specification

Connectors	Input	HDMI 1.3	2×HDMI-A
		USB 3.0	2×USB TypeA
	Output	HDMI 2.0	1×HDMI-A
		Record	USB 2.0
	Audio	In	1×3.5mm audio jack
		Out	1×3.5mm audio jack
	Control/Stream	LAN	1×RJ45
Power		1×PD Type-C	
Performance	Input Resolution	HDMI	
		SMPTE	720p@50/60 1080p@23/24/60
		VESA	1024×768@60 1280×720@60 1280×800@60 1280×1024@60 1360×768@60 1600×1200@60 1680×1050@60 1920×1080@60
	Output Resolution	HDMI	
SMPTE		720p@50/60 1080p@24/25/50/60 2160p@60	
Supported Standard	VESA	1024×768@60 1280×720@50/60 1280×800@60 1280×1024@60 1360×768@60 1920×1080@50/60 3840×2160@60	
	HDMI	1.3(Input) 2.0(Output)	
Screen Feature	Screen Dimension	5.5 ' TFT	
	Resolution	1080×1920 pixels	
	Dot Pitch	0.063(H)×0.021(W)(mm)	
	Aspect Ratio	16:9	
	Brightness	450cd/m ²	
	Contrast	1000:1	
	Backlight	LED	

	View Angle	80°/80°(L/R)80°/80°(U/D)	
Power	Input Voltage	9V/2A	
	Max Power	18W	
Environment	Temperature	0°C~55°C	
	Humidity	5%~85%	
Physical	Weight	Net	350g(without battery);882g(with battery)
		Package	770g
	Dimension	Net	161mm×106mm×36mm
		Package	255mm×145mm×85mm

7.2 Battery Installation



TAO 1pro supports power supply via Type C cable as well as two batteries.

Install: press the lock button first and put the batteries into the slots until it is locked in the correct position.

Remove: press lock button first and remove the batteries.



Following is battery options for your reference.

No.	Image	Model	Capacity	Weight	Working hours
1		NEEWER 970	6600mA	600g	3~4 hours
2		Sony NP-F970	6600mA	300g	3~4 hours

3		Sony NP-F550	1500mA	95g	1 hour
4		Sony NP-F750	3000mA	200g	1.5 hours
5		Sony NP-F570	2200mA	About 100g	1 hours
6		Sony NP-F770	4400mA	About 200g	2~3 hours
7		Sony NP-F960	5400mA	300g	2~3 hours
8		Panasonic AG-VBR59MC	5900mA	300g	3 hours
9		Panasonic D54S	5400mA	300g	2~3 hours
10		Panasonic CGA-D54D	5400mA	300g	2~3 hours

11		Panasonic CGA-D54H	5400mA	300g	2~3 hours
12		Panasonic CGR-D28S	4200mA	300g	2 hours
13		Panasonic CGR-D16S	2200mA	300g	1 hours
14		Panasonic VBD29	2900mA	100g	1~2 hours
15		Panasonic VBD98	10400mA	100g	5 hours

7.3 FAQ

1.TAO 1pro recording automatically stops after 6 seconds?

A: The latest firmware(V1.2.15) has been optimized to avoid automatic recording; The USB flash drive is only available when the USB icon is green. Latest firmware download link:

<https://www.dropbox.com/sh/akcgjcqcsbn8b8q/AAAhYUsU4qVS9P7aD2-qmB46a?dl=0>

2.TAO 1pro failed to record a file?

A: TAO 1pro will identify the files inside the U disk one by one after the recording starts. If the files have not been identified completely, clicking the record will not work. To avoid this, if the file is not fully identified, the icon is left in gray rather than green.

3. What is the recording video format and refresh rate of TAO 1pro?

A: TAO 1pro recording video format follows the streaming RJ45 output, which is MP4 and 1080P30, 8bit.

4. Is media player function supported on TAO 1pro, such as playing recording file ?

A: Currently, the playback function is not supported. It will be available in future firmware version.

5. Introduction to Encoder features of TAO 1pro.

A: TAO 1pro has two encoder functions. The first one is RTMP, which can directly stream directly to YouTube platform and other websites. The second is NDI, terminal NDI encoder function. The two streams cannot be applied at the same time. Only one encoding method can be selected at a time.

6. How much is the streaming delay and external network delay of TAO 1pro?

A: The streaming delay of TAO 1pro is approximately within 100ms, and the delay of external network depends on different networks, generally between 10-20s.

7. The LCD monitor and HDMI of TAO 1pro appear lag, similar to 10Hz.

A: When recording is enabled on TAO 1pro, the corresponding LCD screen and HDMI output will drop to about 10-15 frames. However, both recording and streaming are guaranteed to be at 30HZ.

8. Will the five features of TAO 1Pro, Monitor, Recorder, Switcher, Encoder and Streamer affect each other?

A: Besides Switcher, it is recommended to use only two of the other four functions of TAO 1pro. Otherwise, the output frames of LCD and HDMI will be reduced to 10-15 frames to ensure A 30-frame streaming.

9. Will TAO 1pro's RTMP address change?

A: The RTMP address of TAO 1pro will never change. It is fixed and can be used directly after booting.

10. Does TAO 1pro's signal recognition allow temporary modification of signal resolution?

A: TAO 1pro does not support temporary modification of input resolution after signal intervention, nor does it have EDID function; If the customer needs to change the input resolution, restart the device to identify the front-end signal. The USB and HDMI inputs are the same.

11. What is the recognition of TAO 1pro HDMI signal?

A: the TAO 1pro's HDMI input is only recognized as 1080P 50,60 and 720P (computer signal excluded). Support i format signal input; If computer signal input is used, it must be 1080P50 and 60, others are not supported. TAO 1pro does not support de-interlacing function.

12. Does TAO 1pro have signal hot backup function?

A: TAO 1pro currently does not support signal hot backup, the screen will go black if the signal is lost.

13.TAO 1pro's HDMI output to 4K screen appears incomplete.

A: The use of TAO 1Pro requires that all input and output should be connected before starting up. The plug/plug interface or signal and monitor screen should not be replaced during the process.

7.4 Terms & Definitions

● **RCA:** Connector used primarily in consumer AV equipment for both audio and video. The RCA connector was developed by the Radio Corporation of America.

● **BNC:** Stands for Bayonet Neill-Concelman. A cable connector used extensively in television (named for its inventors). A cylindrical bayonet connector that operates with a twist-locking motion .

● **CVBS:** CVBS or Composite video, is an analog video signal without audio. Most commonly CVBS is used for transmission of standard definition signals. In consumer applications the connector is typically RCA type, while in professional applications the connector is BNC type.

● **YPbPr:** Used to describe the colour space for progressive-scan. Otherwise known as component video.

● **VGA:** Video Graphics Array. VGA is an analog signal typically used on earlier computers. The signal is non-interlaced in modes 1, 2, and 3 and interlaced when using in mode.

● **DVI:** Digital Visual Interface. The digital video connectivity standard that was developed by DDWG (Digital Display Work Group). This connection standard offers two different connectors: one with 24 pins that handles digital video signals only, and one with 29 pins that handles both digital and analog video.

● **SDI:** Serial Digital Interface. Standard definition video is carried on this 270 Mbps data transfer rate. Video pixels are characterized with a 10-bit depth and 4:2:2 color quantization. Ancillary data is included on this interface and typically includes audio or other metadata. Up to sixteen audio channels can be transmitted. Audio is organised into blocks of 4 stereo pairs. Connector is BNC.

● **HD-SDI:** High-definition serial digital interface (HD-SDI), is standardized in SMPTE 292M this provides a nominal data rate of 1.485 Gbit/s.

● **3G-SDI:** Standardized in SMPTE 424M, consists of a single 2.970 Gbit/s serial link that allows replacing dual link HD-SDI.

● **6G-SDI:** Standardized in SMPTE ST-2081 released in 2015, 6Gbit/s bitrate and able to support 2160p@30.

● **12G-SDI:** Standardized in SMPTE ST-2082 released in 2015, 12Gbit/s bitrate and able to support 2160p@60.

● **U-SDI:** Technology for transmitting large-volume 8K signals over a single cable. a signal interface called the ultra high definition signal/data interface (U-SDI) for transmitting 4K and 8K signals using a single optical cable. The interface was standardized as the SMPTE ST 2036-4.

● **HDMI:** High Definition Multimedia Interface: An interface used for the transmission of uncompressed high definition video, up to 8 channels of audio, and control signals, over a single cable.

● **HDMI 1.3:** Released on June 22 2006, and increased the maximum TMDS clock to 340 MHz (10.2 Gbit/s). Support resolution 1920 × 1080 at 120 Hz or 2560 × 1440 at 60 Hz). It added support for 10 bpc, 12 bpc, and 16 bpc color depth (30, 36, and 48 bit/px), called deep color.

● **HDMI 1.4:** Released on June 5, 2009, added support for 4096 × 2160 at 24 Hz, 3840 × 2160 at 24, 25, and 30 Hz, and 1920 × 1080 at 120 Hz. Compared to HDMI 1.3, 3 more features added which are HDMI Ethernet Channel (HEC) , audio return channel (ARC),3D Over HDMI, a new Micro HDMI Connector, an expanded set of color spaces.

-
- **HDMI 2.0:** Released on September 4, 2013 increases the maximum bandwidth to 18.0 Gbit/s. Other features of HDMI 2.0 include up to 32 audio channels, up to 1536 kHz audio sample frequency, the HE-AAC and DRA audio standards, improved 3D capability, and additional CEC functions.
 - **HDMI 2.0a:** Was released on April 8, 2015, and added support for High Dynamic Range (HDR) video with static metadata.
 - **HDMI 2.0b:** Was released March, 2016, support for HDR Video transport and extends the static metadata signaling to include Hybrid Log-Gamma (HLG).
 - **HDMI 2.1:** Released on November 28, 2017. It adds support for higher resolutions and higher refresh rates, Dynamic HDR including 4K 120 Hz and 8K 120 Hz.
 - **DisplayPort:** A VESA standard interface primarily for video, but also for audio, USB and other data. DisplayPort (orDP) is backwards compatible with HDMI, DVI and VGA.
 - **DP 1.1:** Was ratified on 2 April 2007, and version 1.1a was ratified on 11 January 2008. DisplayPort 1.1 allow a maximum bandwidth of 10.8 Gbit/s (8.64 Gbit/s data rate) over a standard 4-lane main link, enough to support 1920x1080@60Hz
 - **DP 1.2:** Introduced on 7 January 2010, effective bandwidth to 17.28 Gbit/s support increased resolutions, higher refresh rates, and greater color depth, maximum resolution 3840 × 2160@60Hz
 - **DP 1.4:** Publish on 1 Mar, 2016. overall transmission bandwidth 32.4 Gbit/s ,DisplayPort 1.4 adds support for Display Stream Compression 1.2 (DSC), DSC is a "visually lossless" encoding technique with up to a 3:1 compression ratio. Using DSC with HBR3 transmission rates, DisplayPort 1.4 can support 8K UHD (7680 × 4320) at 60 Hz or 4K UHD (3840 × 2160) at 120 Hz with 30 bit/px RGB color and HDR. 4K at 60 Hz 30 bit/px RGB/HDR can be achieved without the need for DSC.
 - **Multi-mode Fiber:** Fibers that support many propagation paths or transverse modes are called multi-mode fibers, generally have a wider core diameter and are used for short-distance communication links and for applications where high power must be transmitted.
 - **Single-mode Fiber:** Fiber that support a single mode are called single-mode fibers. Single-mode fibers are used for most communication links longer than 1,000 meters (3,300 ft).
 - **SFP:** Small form-factor pluggable , is a compact, hot-pluggable network interface module used for both telecommunication and data communications applications.
 - **Optical Fiber Connector:** Terminates the end of an optical fiber, and enables quicker connection and disconnection than splicing. The connectors mechanically couple and align the cores of fibers so light can pass. 4 most common types of optical fiber connectors are SC, FC, LC,ST.
 - **SC:** (Subscriber Connector), also known as the square connector was also created by the Japanese company – Nippon Telegraph and Telephone. SC is a push-pull coupling type of connector and has a 2.5mm diameter. Nowadays, it is used mostly in single mode fiber optic patch cords, analog, GBIC, and CATV. SC is one of the most

popular options, as its simplicity in design comes along with great durability and affordable prices.

● **LC** : (Lucent Connector) is a small factor connector (uses only a 1.25mm ferrule diameter) that has a snap coupling mechanism. Because of its small dimensions, it is the perfect fit for high-density connections, XFP, SFP, and SFP+ transceivers.

● **FC**: (Ferrule Connector) is a screw type connector with a 2.5mm ferrule. FC is a round shaped threaded fiber optic connector, mostly used on Datacom, telecom, measurement equipment, single-mode laser.

● **ST**: (Straight Tip) was invented by AT&T and uses a bayonet mount along with a long spring-loaded ferrule to support the fiber.











● **USB**: Universal Serial Bus is a standard that was developed in the mid-1990s that defines cables, connectors and communication protocols. This technology is designed to allow a connection, communication and power supply for peripheral devices and computers.

● **USB 1.1**: Full-Bandwidth USB, specification was the first release to be widely adopted by the consumer market. This specification allowed for a maximum bandwidth of 12Mbps.

● **USB 2.0**: or Hi-Speed USB, specification made many improvements over USB 1.1. The main improvement was an increase in bandwidth to a maximum of 480Mbps.

● **USB 3.2**: Super Speed USB with 3 varieties of 3.2 Gen 1(original name USB 3.0), 3.2Gen 2(original name USB 3.1), 3.2 Gen 2x2 (original name USB 3.2) with speed up to 5Gbps,10Gbps,20Gbps respectively.

USB version and connectors figure:

	Type A	Type B	Mini A	Mini B	Micro-A	Micro-B	Type C
USB 2.0							
USB 3.0							
USB 3.1&3.2							

● **NTSC**: The colour video standard used in North America and some other parts of the world created by the National Television Standards Committee in the 1950s. NTSC utilizes an interlaced video signals.

● **PAL**: Phase Alternate Line. A television standard in which the phase of the colour carrier is alternated from line to line. It takes four full images (8 fields) for the colour-to-horizontal images (8 fields) for the colour-to-horizontal phase relationship to return to the reference point. This alternation helps cancel out phase errors. For this reason, the hue

control is not needed on a PAL TV set. PAL, is widely used in Western Europe, Australia, Africa, the Middle East, and Micronesia. PAL uses 625-line, 50-field (25 fps) composite colour transmission system.

- **SMPTE:** Society of Motion image and Television Engineers. A global organization, based in the United States, that sets standards for baseband visual communications. This includes film as well as video and television standards.
- **VESA:** Video Electronics Standards Association. An organization facilitating computer graphics through standards.
- **HDCP:** High-bandwidth Digital Content Protection (HDCP) was developed by Intel Corporation and is in wide use for protection of video during transmission between devices.
- **HDBaseT:** A video standard for the transmission of uncompressed video (HDMI signals) and related features using Cat 5e/Cat6 cabling infrastructure.
- **ST2110:** A SMPTE developed standard, ST2110 describes how to send digital video over and IP networks. Video is transmitted uncompressed with audio and other data in a separate streams. SMPTE2110 is intended principally for broadcast production and distribution facilities where quality and flexibility are more important.
- **SDVoE:** Software Defined Video over Ethernet (SDVoE) is a method for transmission, distribution and management AV signals using a TCP/IP Ethernet infrastructure for transport with low latency. SDVoE is commonly used in integration applications.
- **Dante AV:** The Dante protocol was developed for and widely adopted in audio systems for the transmission of uncompressed digital audio on IP based networks. The more recent Dante AV specification includes support for digital video.
- **NDI:** Network Device interface (NDI) is a software standard developed by NewTek to enable video-compatible products to communicate, deliver, and receive broadcast quality video in a high quality, low latency manner that is frame-accurate and suitable for switching in a live production environment over TCP (UDP) Ethernet based networks. NDI is commonly found in broadcast applications.
- **RTMP:** Real-Time Messaging Protocol (RTMP) was initially a proprietary protocol developed by Macromedia (now Adobe) for streaming audio, video and data over the Internet, between a Flash player and a server.
- **RTSP:** The Real Time Streaming Protocol (RTSP) is a network control protocol designed for use in entertainment and communications systems to control streaming media servers. The protocol is used for establishing and controlling media sessions between end points.
- **MPEG:** Moving Picture Experts Group is a working group formed from ISO and IEC developing standards that allow audio/video digital compression and Transmission.

● **H.264:** Also known as AVC (Advanced Video Coding) or MPEG-4i is a common video compression standard. H.264 was standardized by the ITU-T Video Coding Experts Group (VCEG) together with the ISO/IEC JTC1 Moving Picture Experts Group (MPEG).

● **H.265:** Also known as **HEVC** (High Efficiency Video Coding) H.265 is the successor to the widely used H.264/AVC digital video coding standard. Developed under the auspices of ITU, resolutions up to 8192x4320 may be compressed.

● **API:** An Application Programming Interface (API) provides a predefined function which allows access capabilities and features or routines via a software or hardware, without accessing source code or understanding the details of inner working mechanism. An API call may execute a function and/or provide data feedback/report.

● **DMX512:** The communication standard developed by USITT for entertainment and digital lighting systems. The wide adoption of the Digital Multiplex (DMX) protocol has seen the protocol used for a wide range of other devices including video controllers. DMX512 is delivered over cable of 2 twisted pairs with 5pin XLR cables for connection.

● **ArtNet:** An ethernet protocol based on TCP/IP protocol stack, mainly used in entertainment/events applications. Built on the DMX512 data format, ArtNet enables multiple “universes” of DMX512 to be transmitted using ethernet networks for transport.

● **MIDI:** MIDI is the abbreviation of Musical Instrument Digital Interface. As the name indicates the protocol was developed for communication between electronic musical instruments and latterly computers. MIDI instructions are triggers or commands sent over twisted pair cables, typically using 5pin DIN connectors.

● **OSC:** The principle of Open Sound Control (OSC) protocol is for networking sound synthesizers, computers, and multimedia devices for musical performance or show control. As with XML and JSON, the OSC protocol allows sharing data. OSC is transported via UDP packets between devices connected on an Ethernet.

● **Brightness:** Usually refers to the amount or intensity of video light produced on a screen without regard to colour. Sometimes called black level.

● **Contrast Ratio:** The ratio of the high light output level divided by the low light output level. In theory, the contrast ratio of the television system should be at least 100:1, if not 300:1. In reality, there are several limitations. Well-controlled viewing conditions should yield a practical contrast ratio of 30:1 to 50:1.

● **Colour Temperature:** The colour quality, expressed in degrees Kelvin (K), of a light source. The higher the colour temperature, the bluer the light. The lower the temperature, the redder the light. Benchmark colour temperature for the A/V industry include 5000°K, 6500°K, and 9000°K.

● **Saturation:** Chroma, Chroma gain. The intensity of the colour, or the extent to which a given colour in any image is free from white. The less white in a colour, the truer the colour or the greater its saturation. Saturation is the amount of pigment in a colour, and not the intensity.

-
- **Gamma:** The light output of a CRT is not linear with respect to the voltage input. The difference between what you should have and what is actually output is known as gamma.
 - **Frame:** In interlaced video, a frame is one complete image. A video frame is made up of two fields, or two sets of interlaced lines. In a film, a frame is one still image of a series that makes up a motion image.
 - **Genlock:** Allows synchronisation of otherwise video devices. A signal generator provides a signal pulses which connected devices can reference. Also see Black Burst and Color Burst.
 - **Blackburst:** The video waveform without the video elements. It includes the vertical sync, horizontal sync, and the Chroma burst information. Blackburst is used to synchronize video equipment to align the video output.
 - **Colour Burst:** In colour TV systems, a burst of subcarrier frequency located on the back part of the composite video signal. This serves as a colour synchronizing signal to establish a frequency and phase reference for the Chroma signal. Colour burst is 3.58 MHz for NTSC and 4.43 MHz for PAL.
 - **Colour Bars:** A standard test pattern of several basic colours (white, yellow, cyan, green, magenta, red, blue, and black) as a reference for system alignment and testing. In NTSC video, the most commonly used colour bars are the SMPTE standard colour bars. In PAL video, the most commonly used colour bars are eight full field bars. On computer monitors the most commonly used colour bars are two rows of reversed colour bars
 - **Seamless Switching:** A feature found on many video switchers. This feature causes the switcher to wait until the vertical interval to switch. This avoids a glitch (temporary scrambling) which often is seen when switching between sources.
 - **Scaling:** A conversion of a video or computer graphic signal from a starting resolution to a new resolution. Scaling from one resolution to another is typically done to optimize the signal for input to an image processor, transmission path or to improve its quality when presented on a particular display.
 - **PIP:** Picture-In-Picture. A small image within a larger image created by scaling down one of image to make it smaller. Other forms of PIP displays include Picture-By-Picture (PBP) and Picture- With-Picture (PWP), which are commonly used with 16:9 aspect display devices. PBP and PWP image formats require a separate scaler for each video window.
 - **HDR:** is a high dynamic range (HDR) technique used in imaging and photography to reproduce a greater dynamic range of luminosity than what is possible with standard digital imaging or photographic techniques. The aim is to present a similar range of luminance to that experienced through the human visual system.
 - **UHD:** Standing for Ultra High Definition and comprising 4K and 8K television standards with a 16:9 ratio, UHD follows the 2K HDTV standard. A UHD 4K display has a physical resolution of 3840x2160 which is four times the area

and twice both the width and height of a HDTV/FullHD (1920x1080) video signal.

● **EDID:** Extended Display Identification Data. EDID is a data structure used to communicate video display information, including native resolution and vertical interval refresh rate requirements, to a source device. The source device will then output the provided EDID data, ensuring proper video image quality.

7.5 Revision History

The table below lists the changes to the User Manual.

Format	Time	ECO#	Description	Principal
V1.0	2021-07-19	0000#	Release	Sylvia
V1.1	2021-08-06	0001#	Update upgrade guide	Sylvia
V1.2	2021-08-16	0002#	Update UI	Sylvia
V1.3	2021-09-26	0003#	1. change to 2 HDMI 1.4 input 2. Update UI	Sylvia
V1.4	2021-11-22	0004#	1. Update mode 2. Add FAQ	Sylvia
V1.5	2022-05-07	0005#	1. Update UI 2. Update upgrade guideline	Aster

All information herein is Xiamen RGBlink Science & Technology Co Ltd. excepting noted. **RGBlink**® is a registered trademark of Xiamen RGBlink Science & Technology Co Ltd.

While all efforts are made for accuracy at time of printing, we reserve the right to alter otherwise make change without notice.