



MXA710

2-Foot and 4-Foot Linear Array Microphone

Shure MXA710 linear array microphone user guide. Learn how to install the mic in a variety of rooms and how to use Shure's trusted IntelliMix DSP platform.

Version: 4.9 (2023-C)

Table of Contents

MXA710 2-Foot and 4-Foot Linear Array Microphone	4	Firmware Versioning	20
Getting Started	4	IntelliMix DSP	20
Step 1: Connect to a Network and Discover Devices	4	DSP Best Practices	21
Step 2: Route Audio and Apply DSP	4	Acoustic Echo Cancellation	21
Step 3: Adjust Microphone Coverage	5	Noise Reduction	22
General Description	6	Automatic Gain Control (AGC)	22
Features	6	Delay	23
MXA710 Parts	6	Compressor	23
Model Variations	8	Automix	23
Power Over Ethernet (PoE)	8	Automix Settings	23
Cable Requirements	9	Automix Modes	24
Controlling Devices with Shure Designer Software	9	Automix Channel	24
What's in the Box	9	Mute Sync	24
Reset Button	9	Parametric Equalizer	25
Reset Modes	10	Setting Filter Parameters	25
Using Designer's Optimize Workflow	10	Copy, Paste, Import, and Export Equalizer Channel Settings	26
How to Adjust Microphone Coverage	11	Equalizer Applications	27
MXA710 Coverage Examples	11	EQ Contour	27
Using Autofocus to Improve Coverage	15	Networking Best Practices	28
Adjusting Levels	16	Switch and Cable Recommendations for Dante Networking	28
Installation Guide	16	Setting Latency	28
Choosing Where to Install the MXA710	16	Device IP Configuration	29
Suspending the Microphone from the Ceiling	17	QoS (Quality of Service) Settings	29
Installing the Wall-Mounting Bracket	18	Digital Audio Networking	29
VESA MIS-B Compatibility	20	Compatibility with Dante Domain Manager	30
Covering the Microphone with Fabric	20	Dante Flows for Shure Devices	30
How to Update Firmware Using Designer	20	AES67	30
		Sending Audio from a Shure Device	31

Receiving Audio from a Device Using a Different Audio Network Protocol	31	MXA710 Frequency Response	35
		Lobe Sensitivity	35
IP Ports and Protocols	31	Contact Customer Support	36
Using Command Strings	32	IMPORTANT SAFETY INSTRUCTIONS	36
Optional Accessories	32	Important Product Information	37
Specifications	33	Information to the user	37

MXA710

2-Foot and 4-Foot Linear Array Microphone

Getting Started

To control MXA710 microphones, use Shure Designer software. After completing this basic setup process, you should be able to:

- Discover the MXA710 in Designer
- Design microphone coverage
- Apply DSP and route signals

You will need:

- Cat5e (or better) Ethernet cable
- Network switch that provides Power over Ethernet (PoE)
- Shure Designer software installed on a computer. Download at www.shure.com/designer.

Step 1: Connect to a Network and Discover Devices

1. After installing your microphone, connect it to a PoE port on the network switch using Cat5e (or better) cable.
2. Connect your computer running Designer to the same network.
3. Open Designer. Check that you're connected to the correct network in Settings.
4. Click Online devices. A list of online devices appears.
5. To identify devices, click the product icon to flash the lights on a device. Find the MXA710 in the list.

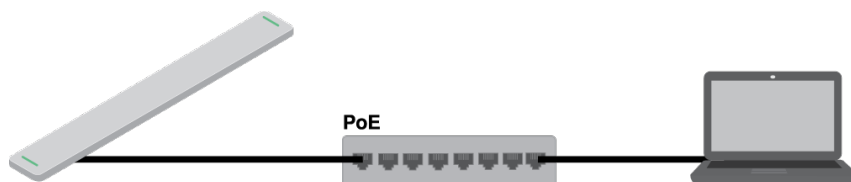

Step 2: Route Audio and Apply DSP

The easiest way to route audio and apply DSP is with Designer's Optimize workflow. Optimize automatically routes audio signals, applies DSP settings, turns on mute synchronization, and enables LED logic control for connected devices.

The MXA710 includes IntelliMix[®] DSP that can be applied to the automix channel output.

For this example, we'll connect an MXA710 and an ANIUSB-MATRIX.

1. Go to My projects > New to create a new project.
2. Select New > Room (Live) to create a new room. Any online devices appear in the list. Drag and drop the MXA710 and the ANIUSB-MATRIX to add them to your room.

Designer prompts you to choose an installation method for the MXA710. You can change this setting later in Coverage map.

3. Select Optimize.

4. Check the audio routes and settings to make sure they fit your needs. You might need to:
 - Delete unnecessary routes.
 - Verify that AEC reference signals are correctly routed.
 - Fine-tune DSP blocks as needed.

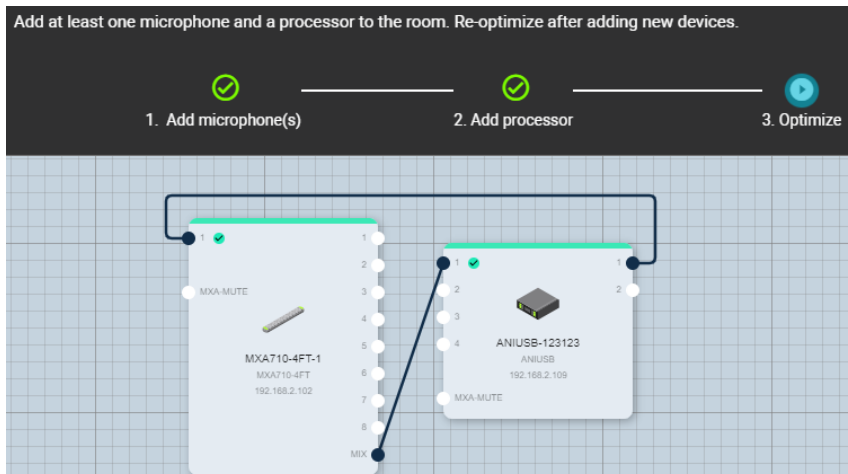

You can also route audio manually in Designer outside of the Optimize workflow, or use Dante Controller.

Step 3: Adjust Microphone Coverage

1. Go to Coverage map to adjust the MXA710's coverage. Choose a device installation template:
 - Wall horizontal
 - Wall vertical
 - Ceiling
 - Table

These templates are designed and tested to fit most common installations, but you can adjust lobe position and width as needed.

2. Listen to each of your microphone's channels and adjust the lobe position, width, and gain as needed. The solid line in each lobe shows where pickup is the strongest. The lobe's edge is -6 dB down from the solid line.

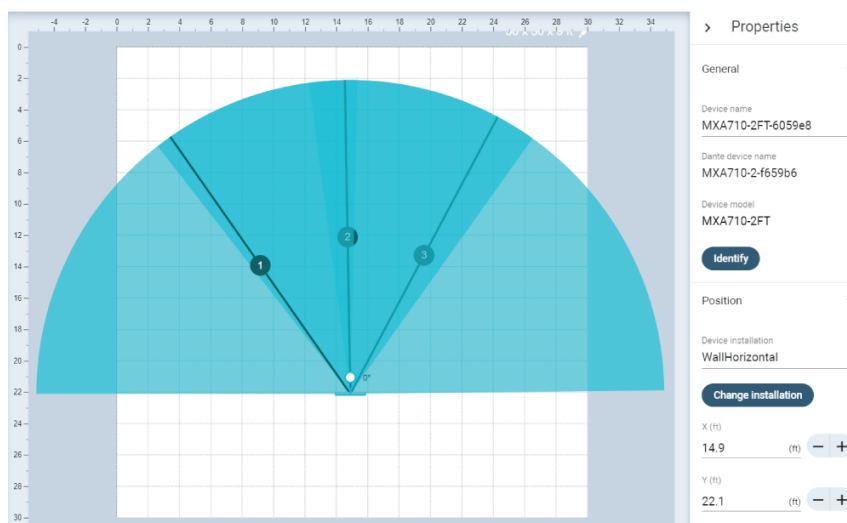

After you have coverage set up, you can send audio from the ANIUSB-MATRIX to other Dante devices or analog sources.

General Description

The Shure Microflex® Advance™ MXA710 Linear Array Microphone represents the next evolution in Shure array microphone technology, designed for high-quality audio capture in premium AV conferencing environments. The linear form factor of the MXA710 allows for placement virtually anywhere in a meeting space, including on a wall, around a display, on a ceiling, or in a conference room table. Available in 2- and 4-foot lengths in 3 colors, the MXA710 includes proprietary IntelliMix DSP and Autofocus™ technology that provides all the processing needed for echo- and noise-free audio.

Features

- Steerable Coverage™ technology to capture audio anywhere in the room (up to 4 lobes with a 2-foot array, 8 lobes with a 4-foot array)
 - Autofocus technology fine-tunes each lobe position in real time, even if meeting participants lean back or stand up.
 - Default room coverage template enables quick and easy lobe optimization for wall, ceiling, or table installations.
 - IntelliMix DSP includes automatic mixing, acoustic echo cancellation, noise reduction, and automatic gain control.
 - Shure Designer System Configuration software for easy setup and configuration
 - SystemOn Audio Asset Management software for remote management and troubleshooting
 - PoE powered
 - LED status bars with configurable colors and brightness
 - Dante & AES67 audio networking protocols
 - Shure network audio encryption compatible
 - Multiple mounting accessories available for wall, ceiling, or table installation
-

MXA710 Parts

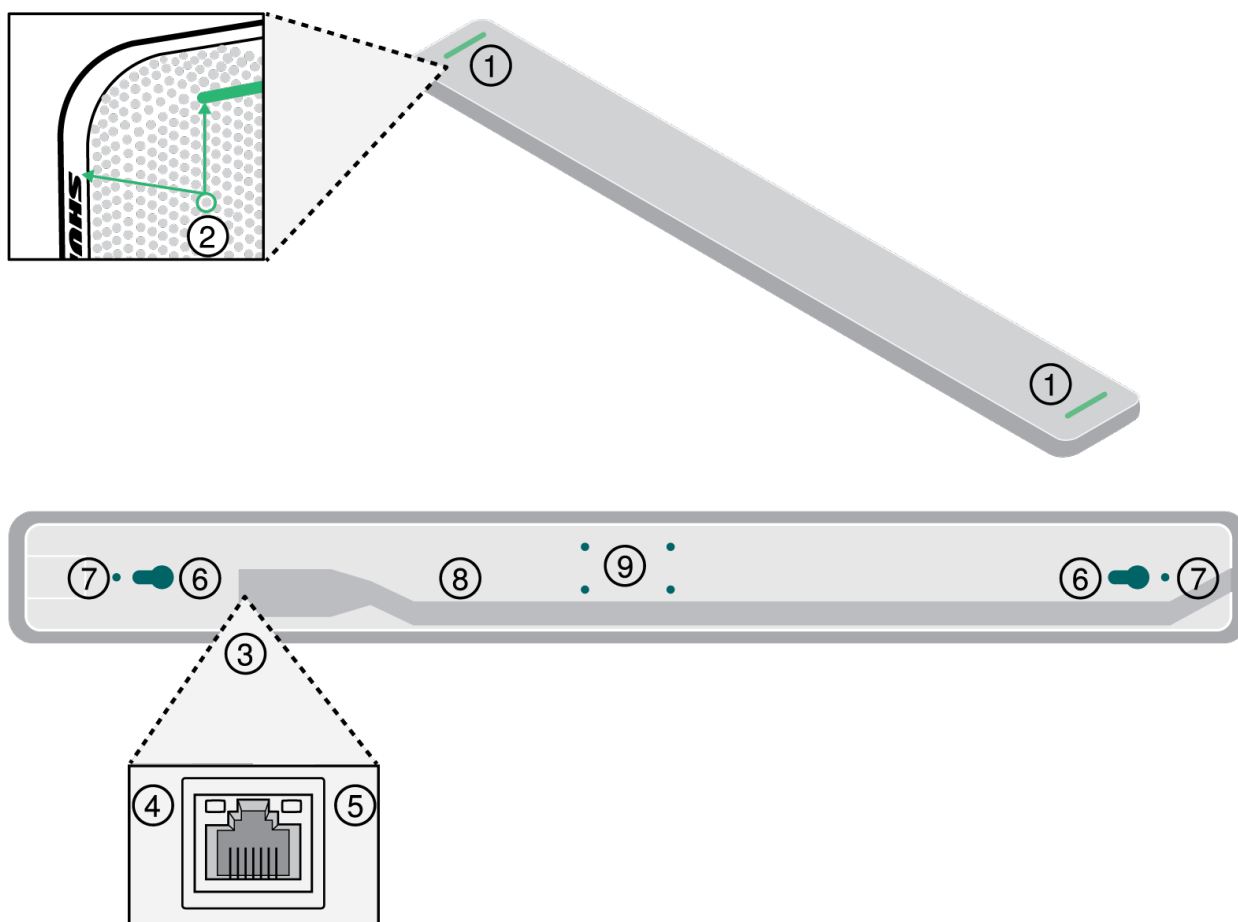

1. Mute status LED

Customize LED color and behavior in Designer by going to: Device configuration > Settings > Lights.

Mute Status LED Default Settings

Microphone Status	LED Color/Behavior
Active	Green (solid)
Muted	Red (solid)
Hardware identification	Green (flashing)
Firmware update in progress	Green (progresses along bar)
Reset	Network reset: Red (progresses along bar) Factory reset: Triggers device power-up
Error	Red (split, alternate flashing)
Device power-up	Multi-color flash, then blue (moves quickly back and forth across bar)

Note: If LEDs are disabled, they will still turn on when the device powers up or when an error state occurs.

2. Reset button

Sits behind the microphone grille. To access, find a grille hole that aligns with the left edge of the mute status LED and the "S" of the Shure logo. Use a small paperclip or other tool to press and hold the button. You may need to try a few different holes to press the reset button.

3. Network port

RJ-45 jack for network connection. Power over Ethernet is required to power the microphone.

4. Network status LED (green)

- Off = No network link
- On = Network link established
- Flashing = Network link active

5. Network speed LED (amber)

- Off = 10/100 Mbps
- On = 1 Gbps

6. Mounting keyholes

Use to attach the microphone to the wall-mounting bracket.

7. Screw holes for suspension mounting

Use to attach eyelet screws to hold braided metal cable or other high-strength wire for suspension mounting.

8. Cable exit

Route the Ethernet cable here to keep it flush with the microphone.

9. Screw holes (VESA MIS-B compatibility)

Use to attach the desk stand, the microphone stand mount, or other VESA MIS-B-compatible adapters.

Model Variations

SKU	Description
MXA710B-2FT	Black 2-foot microphone (60 cm)
MXA710W-2FT	White 2-foot microphone (60 cm)
MXA710AL-2FT	Aluminum 2-foot microphone (60 cm)
MXA710B-4FT	Black 4-foot microphone (120 cm)
MXA710W-4FT	White 4-foot microphone (120 cm)
MXA710AL-4FT	Aluminum 4-foot microphone (120 cm)

Power Over Ethernet (PoE)

This device requires PoE to operate. It is compatible with **Class 0** PoE sources.

Power over Ethernet is delivered in one of the following ways:

- A network switch that provides PoE
- A PoE injector device

Cable Requirements

Always use Cat5E cable or higher.

Controlling Devices with Shure Designer Software

To control this device's settings, use Shure Designer software. Designer enables integrators and system planners to design audio coverage for installations using MXA microphones and other Shure networked devices.

To access your device in Designer:

1. Download and install Designer on a computer connected to the same network as your device.
2. Open Designer, and check that you're connected to the correct network in Settings.
3. Click Online devices. A list of online devices appears.
4. To identify devices, click the product icon to flash the lights on a device. Select your device in the list and click Configure to control device settings.

Learn more at shure.com/designer.

You can also access device settings using [Shure Web Device Discovery](#).

What's in the Box

2-foot or 4-foot linear array microphone	MXA710-2FT or MXA710-4FT
Wall-mounting bracket (2 or 4-foot)	RPM710-2M or RPM710-4M
Hardware kit with: Wall cover plate and screws (US and UK versions) Mounting eyelet screws (2) Washers for eyelet screws (2) Cable ties (2)	RPM710-H

Reset Button

The reset button is behind the grille and can be pushed with a small paperclip or other tool. To access the button:

1. Find the end of the microphone that has the Shure logo printed on the side.
2. Find the left edge of the microphone light, which sits behind the grille.
3. Insert the paperclip into the grille hole that aligns with the left edge of the microphone light and the "S" of the Shure logo. Press and hold to reset the microphone. If you don't feel a button, try the grille holes below and around the first one. You may need to try a few different holes to press the reset button.

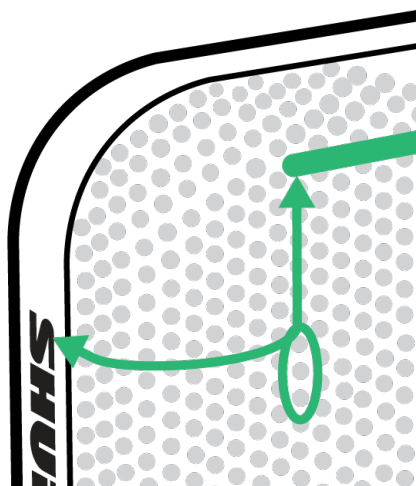

Reset Modes

- **Network reset** (press for 4-8 seconds): Resets all Shure control and audio network IP settings to factory defaults. Red LED along bar.
- **Full factory reset** (press for more than 8 seconds): Resets all network and configuration settings to the factory defaults. Multicolor flash, then blue LED along bar.

Using Designer's Optimize Workflow

Designer's Optimize workflow speeds up the process of connecting systems with at least 1 microphone and 1 audio processor. Optimize also creates mute control routes in rooms with MXA network mute buttons. When you select Optimize in a room, Designer does the following:

- Creates audio routes and mute control routes
- Adjusts audio settings
- Turns on mute synchronization
- Enables LED logic control for applicable devices

The settings are optimized for your particular combination of devices. You can customize settings further, but the Optimize workflow gives you a good starting point.

After optimizing a room, you should check and adjust settings to fit your needs. These steps may include:

- Deleting unnecessary routes.
- Checking levels and adjusting gain.
- Verifying that AEC reference signals are correctly routed.
- Fine-tuning DSP blocks as needed.

Compatible devices:

- MXA910
- MXA920
- MXA710
- MXA310
- P300

- IntelliMix Room
- ANIUSB-MATRIX
- MXN5-C
- MXA Network Mute Button

To use the Optimize workflow:

1. Place all relevant devices in a room.
2. Select Optimize. Designer optimizes microphone and DSP settings for your equipment combination.

If you remove or add devices, select Optimize again.

How to Adjust Microphone Coverage

To control microphone coverage, use Designer. Microphone coverage is at the room level, meaning that there is one coverage map for all microphones in a room.

1. Go to [Your room] > Coverage map.
2. Drag your microphone onto the coverage map if it isn't there already. The first time you do this, you'll be prompted to choose an installation orientation. There are 4 options:
 - Wall horizontal
 - Wall vertical
 - Ceiling
 - Table

These coverage templates are designed and tested to fit most common installations.

3. Adjust each lobe's width (narrow, medium, or wide) and position as needed in the Properties panel. Adjust the microphone's position and orientation to match your room's layout.
4. Listen to each of your microphone's channels and adjust the lobe position, width, and gain as needed.

The solid blue line in each lobe represents where the coverage is the strongest. The edge of the blue coverage area for each lobe represents where the lobe's sensitivity reaches -6 dB.

Autofocus technology fine-tunes each lobe position in real time, even if meeting participants lean back or stand up.

Tips for Great Coverage

- Click and drag lobes to change their position.
- Select the microphone and go to Properties > Position to change the installation type.
- Lobes can cover 1 talker or many talkers depending on width. Test and listen to your settings, and adjust as needed.
- **Ceiling installations:** For best coverage, avoid using narrow lobes.
- Lobes are bidirectional in some positions because of the microphone's pickup pattern.

MXA710 Coverage Examples

Use these images to understand how the coverage patterns work in different installations. Always listen to lobes as you move them into position. Have someone talk from each lobe position to make sure that you have good coverage.

Wall Vertical (2-foot microphone)

- 1 lobe. Go to Open side view to adjust the vertical angle.

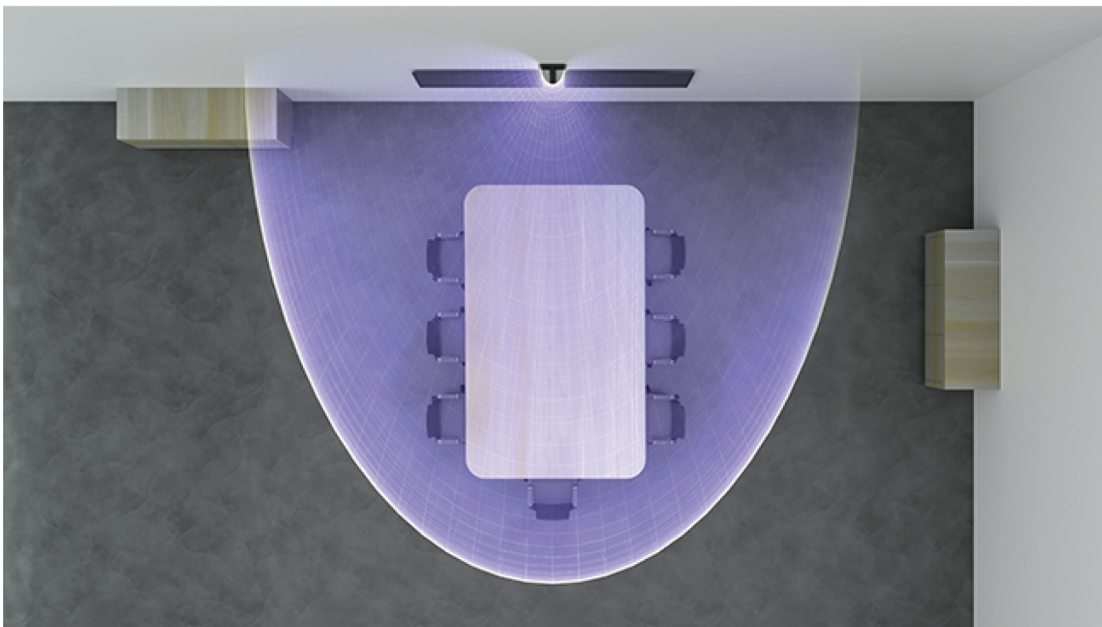
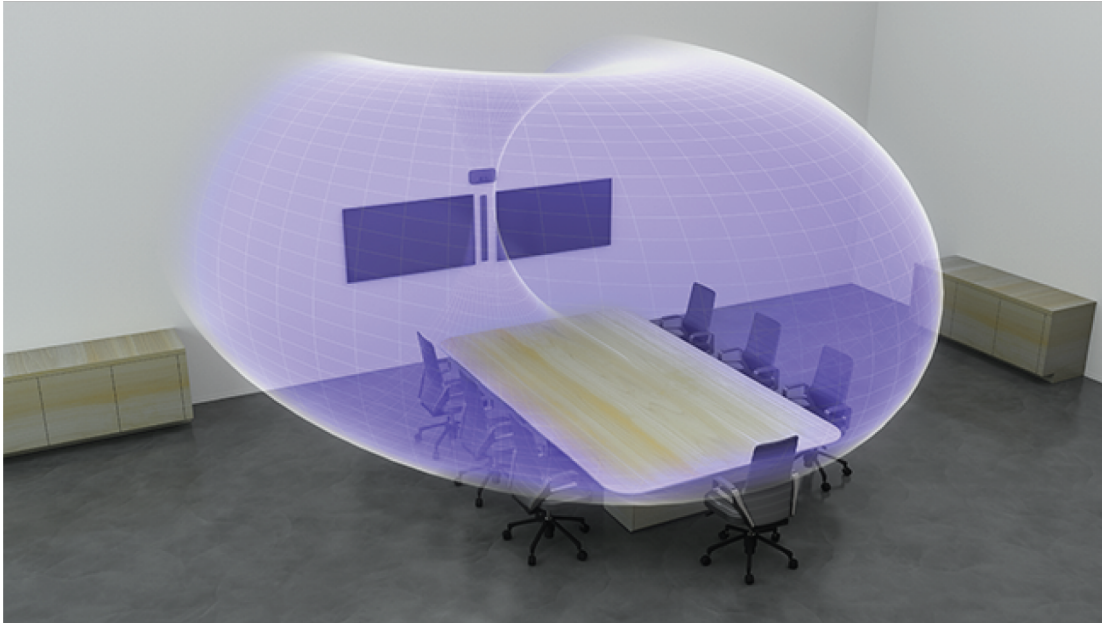

Wall Horizontal (4-foot microphone)

3 lobes

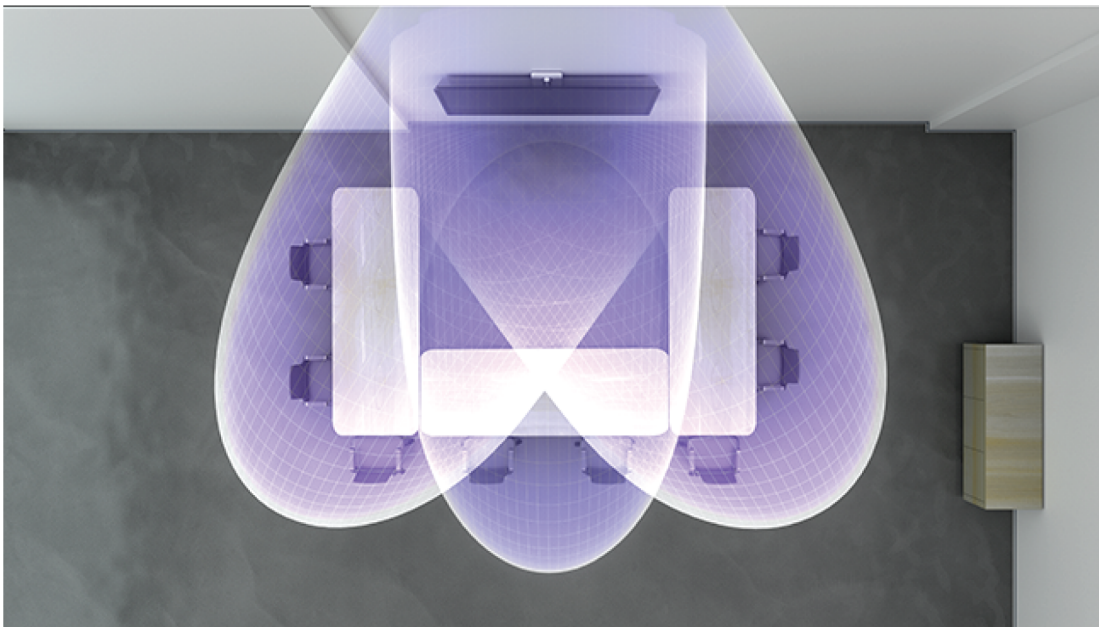

Ceiling (2-foot microphone installed flush with ceiling)

3 lobes. Some are bidirectional in certain positions.

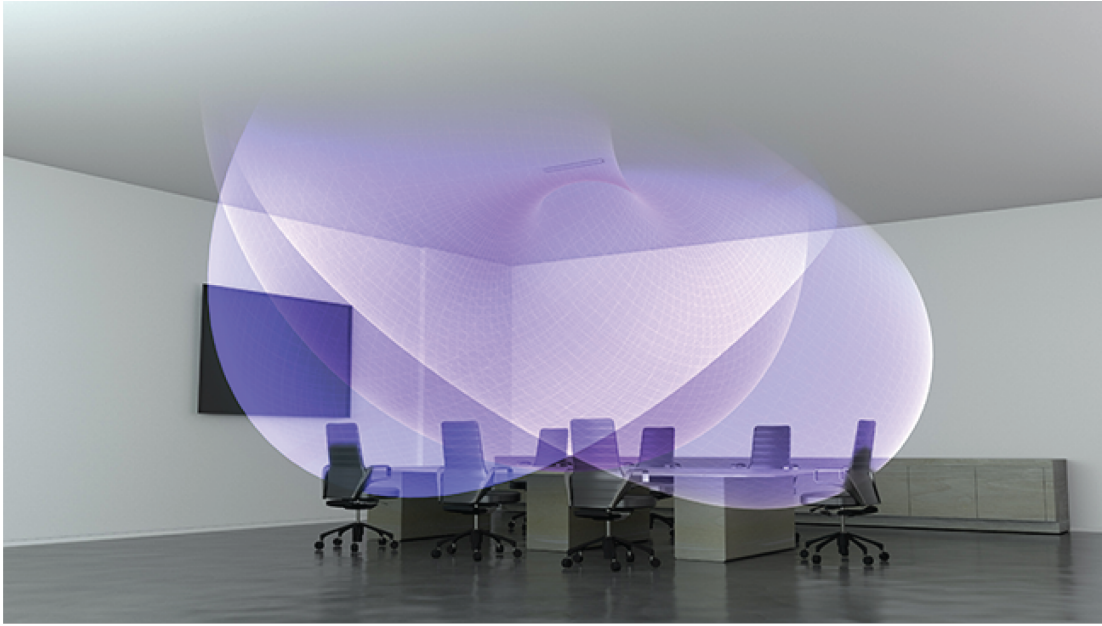
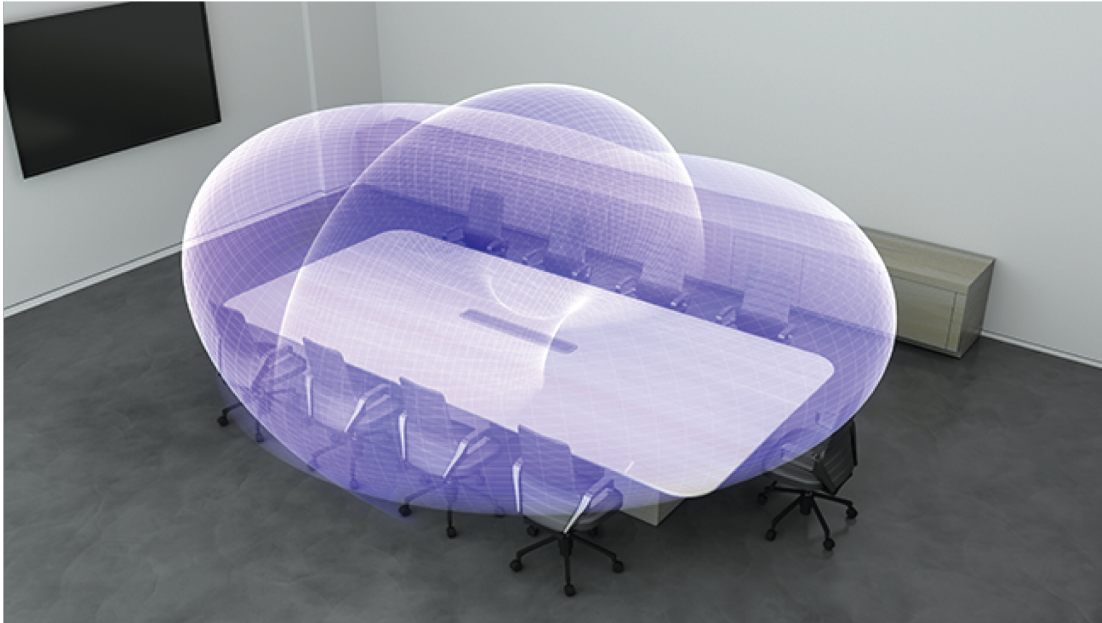

Table (2-foot microphone)

3 lobes. Some are bidirectional in certain positions.



Using Autofocus to Improve Coverage

This microphone uses built-in Autofocus technology to fine-tune each lobe's position in real time, even if meeting participants lean back or stand up. You'll see the lobes moving in Designer's coverage map as participants shift positions. Autofocus only responds to in-room sound sources.

For best results with Autofocus, always route a reference source to the microphone's AEC Reference In channel. Even if you're only using direct outputs from the microphone and a different DSP, route a reference signal to the microphone's AEC Reference In channel to take full advantage of Autofocus.

Adjusting Levels

Gain levels on MicroflexAdvance microphones must be set for each saved coverage preset to ensure an optimized gain structure for all seating scenarios. Always adjust the levels before making any changes to automix settings to ensure the best performance.

1. Perform a level check for each coverage area, using a typical speech volume. Adjust the faders so the meters are peaking at approximately -20 dBFS.
2. Adjust the equalizer settings to optimize speech intelligibility and minimize noise (such as low-frequency rumble caused by HVAC systems).
3. If equalizer settings cause a significant increase or decrease in levels, make any necessary level adjustments according to step 1.

When to Use the Channel and IntelliMix Gain Faders

There are 2 different gain faders that serve different purposes:

Channel Gain (Pre-Gate)

To adjust, go to Channels. These faders affect a channel's gain before it reaches the automixer and therefore affect the automixer's gating decision. Boosting the gain here will make the lobe more sensitive to sound sources and more likely to gate on. Lowering gain here makes the lobe less sensitive and less likely to gate on. If you're only using direct outputs for each channel without the automixer, you only need to use these faders.

IntelliMix Gain (Post-Gate)

To adjust, go to Configuration > IntelliMix. These faders adjust a channel's gain after the lobe has gated on. Adjusting the gain here will not affect the automixer's gating decision. Only use these faders to adjust the gain of a talker after you are satisfied with the automixer's gating behavior.

Installation Guide

Choosing Where to Install the MXA710

The MXA710 is an extremely versatile microphone. You can install it in many places in a conference room and easily get good coverage for all talkers.

	MXA710-2FT	MXA710-4FT
Room size	Small to medium	Medium to large
Maximum number of lobes	4	8
Recommended distance from talkers	2 to 16 feet	4 to 20 feet

Best Practices for Installation

- Before installing, open the microphone's coverage map in Designer. Look at the 4 device installation templates to understand how the lobes behave when you move them around and use different widths. Lobes also have Autofocus technology, which fine-tunes each lobe position in real time, even if meeting participants lean back or stand up. Templates are available for:
 - Wall horizontal
 - Wall vertical
 - Ceiling

- Table
- Measure your space and make sure that all talkers will fit in the microphone's coverage area.
- Coverage also depends on your room's acoustics, construction, and materials. Take these into consideration when planning coverage.
- Don't place the microphone behind obstructions. Keep the microphone's grille at least 36 inches away from any occupancy sensors.
- Plan for any future coverage needs.

Ways to Install the MXA710

Accessory	Install location	Other hardware required?
Wall-mounting bracket	Wall	Drywall mounting screws and anchors
Display mount kit	Attach to display mount	Peerless Universal Sound Bar Kit, Chief Thinstall Center Channel Speaker Adapter, or other similar adapter with VESA MIS-B compatibility
Suspended Cable	Ceiling	Braided metal cable Hardware to attach cable to ceiling or A710-TB Tile Bridge
A710-TB Tile Bridge	Drop ceiling tile	No
A710-FM Flush Mount	Table, wall, or hard ceiling	No
A710-MSA Mic Stand Accessory	Mic stand	Mic stand
A710-DS Desk Stand	Credenza or other flat surface	No

Suspending the Microphone from the Ceiling

To get started, you will need:

- 2 mounting eyelet screws (4 mm diameter)
 - 2 washers
 - Braided metal cable or high-strength wire*
 - Hardware to attach cable to ceiling*
1. Place the washers over the microphone's mounting holes and attach the eyelet screws to the microphone.
 2. Attach the mounting cables to the eyelets.
 3. Attach the cables to the ceiling using the appropriate hardware.

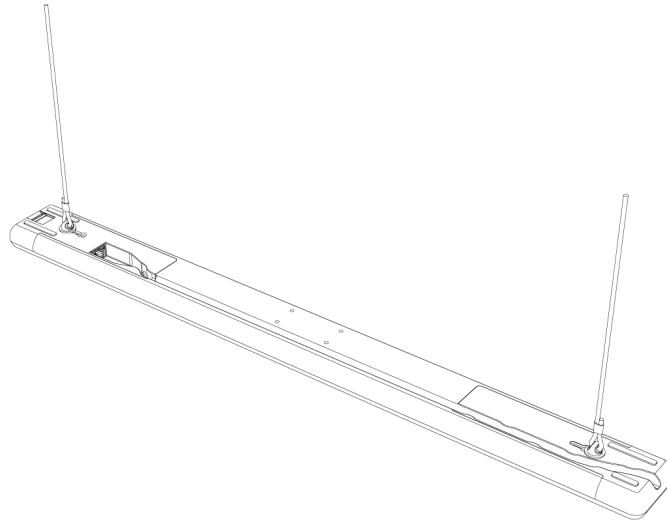

* Not included

Shure also sells the [A710-TB tile bridge](#), which attaches to the microphone's screw holes like the suspension cable in step 1 above. Use the hardware included with the tile bridge to attach to the microphone.

Installing the Wall-Mounting Bracket

You can mount the bracket directly over a junction box, or at any other cable exit on the wall. The bracket works positioned vertically or horizontally.

To get started, you will need:

- Wall-mounting bracket
- Cover plate (US or UK) and screws (if using)
- 4 drywall anchors and screws
- Screwdriver
- Drill
- Cat5e or better Ethernet cable

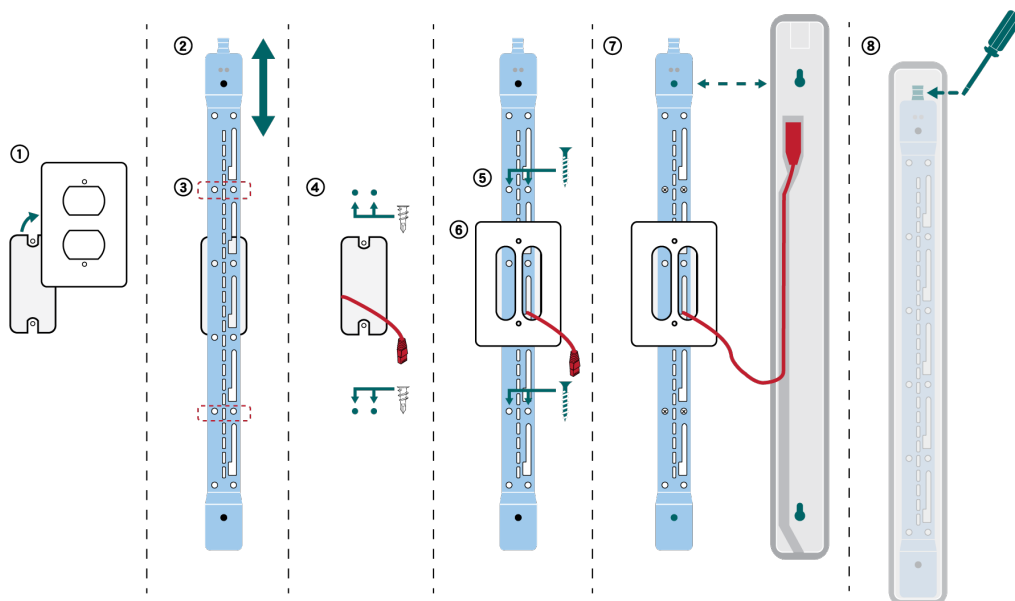

1. If you're mounting over a junction box, remove the existing cover plate.
2. Position the wall-mounting bracket. You can mount it vertically or horizontally on the wall.
3. Using a pencil, mark the wall for the position of the drywall anchors and screws. If you're installing over a junction box, balance the bracket with 2 screws above the box and 2 screws below it.
4. Remove the bracket and drill the holes for the drywall anchors. Install the drywall anchors.
5. Place the bracket on the wall and insert the drywall screws into the anchors to secure the bracket.
6. Thread the Ethernet cable through one of the large openings in the bracket. If you're mounting over a junction box, thread the cable through the provided cover plate and install the cover plate over the bracket.
7. Connect the Ethernet cable to the microphone. Align the holes on the back of the microphone with the raised posts on the bracket and slide the microphone into the bracket until it clicks into place.
8. To remove the microphone, press the tab at the top of the bracket with a screwdriver or other tool and slide the microphone up.

Other mounting options:

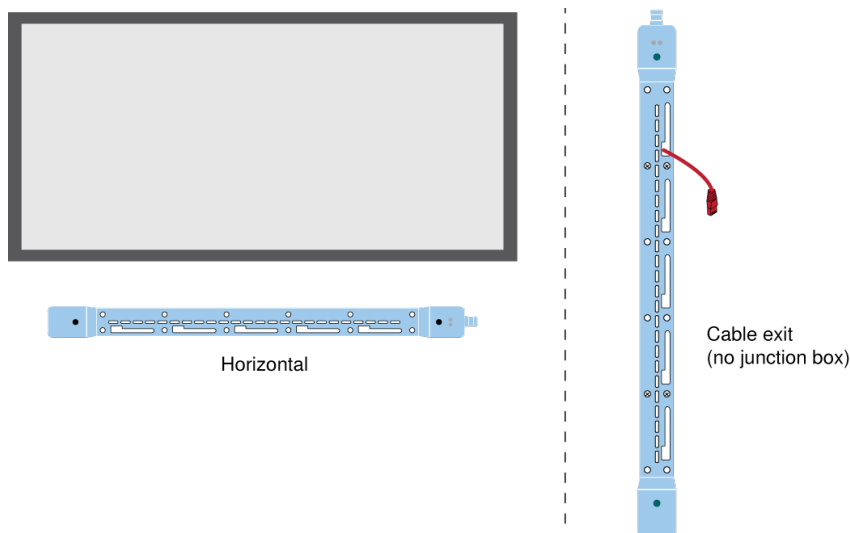

Shure also sells the [A710-FM flush mount kit](#), which attaches to the microphone's mounting keyholes like the wall bracket in step 7 above.

VESA MIS-B Compatibility

The 4 screw holes (for M4 x 10 mm screws) on the bottom of the microphone are compatible with VESA MIS-B mounting products, such as the Peerless Universal Sound Bar Kit or the Chief Thinstall Center Channel Speaker Adapter.

Covering the Microphone with Fabric

In certain installations, covering the microphone or the mounting hardware with fabric may be desirable. Shure has tested the acoustic performance of this microphone with some fabrics from [Guilford of Maine](#) and [Kvadrat](#).

In our tests, there was little effect on the microphone's acoustic performance if the fabric met one of the following specifications. **To cover the microphone, the fabric should meet at least one of these specifications:**

- Specific airflow resistance of ≤ 254 Pa*s/m (Pascal-second per meter)
- Any Guilford of Maine fabric with ≥ 0.95 NRC (noise reduction coefficient) rating

These are examples of fabrics that met our specifications at the time when Shure evaluated fabrics: Guilford of Maine's Bee-Have, and Kvadrat's Ginger, Mi Casa, Casita, and Time.

For best results:

- Use only 1 layer of fabric over the microphone or mounting hardware.
- Always confirm the fabric's acoustic specifications and testing process with the fabric manufacturer. Shure doesn't keep track of any changes in fabric specifications.

How to Update Firmware Using Designer

Applies to Designer 4.2 and newer.

Before setting up devices, check for firmware updates using Designer to take advantage of new features and improvements. You can also install firmware using [Shure Update Utility](#) for most products.

To update:

1. Open Designer. If there's new firmware that you haven't downloaded yet, Designer shows a banner with the number of updates available. Click to download firmware.
2. Go to Online devices and find your devices.
3. Choose a firmware version for each device from the Available firmware column. Make sure that no one is editing device settings during an update.
4. Select the checkbox next to each device you plan to update and click Update firmware. Devices may disappear from Online devices during an update. Don't close Designer while updating firmware.

Firmware Versioning

When updating firmware, update all hardware to the same firmware version to ensure consistent operation.

The firmware of all devices has the form of MAJOR.MINOR.PATCH (e.g., 1.2.14). At a minimum, all devices on the network, must have the same MAJOR and MINOR firmware version numbers (e.g., 1.2.x).

IntelliMix DSP

This device contains IntelliMix digital signal processing blocks that can be applied to the automix channel output. The DSP blocks include:

- Acoustic echo cancellation (AEC)
- Automatic gain control (AGC)
- Noise reduction
- Compressor
- Delay

To access the DSP blocks, select the IntelliMix tab. When enabled, each DSP block will be colored.

Selecting Bypass IntelliMix will bypass the following DSP blocks: AEC, AGC, noise reduction, compressor, and delay.

DSP Best Practices

- Apply DSP blocks only as needed. Run a test of your system without DSP, and then add processing as needed to fix any issues that you hear in the audio signal.
- Unless you encounter video that lags behind audio, set Delay to off.
- DSP blocks do not affect whether the automixer gates a channel on or off.

Acoustic Echo Cancellation

In audio conferencing, a far-end talker may hear their voice echo as a result of a near-end microphone capturing audio from loudspeakers. Acoustic echo cancellation (AEC) is a DSP algorithm which identifies the far-end signal and stops it from being captured by the microphone to deliver clear, uninterrupted speech. During a conference call, the AEC works constantly to optimize processing as long as far-end audio is present.

When possible, optimize the acoustic environment using the following tips:

- Reduce speaker volume
- Position speakers farther from microphones
- Avoid pointing speakers directly at microphone coverage areas

Selecting a Reference Signal for AEC

To apply AEC, provide a far end reference signal. For best results, use the signal that also feeds your local reinforcement system.

P300: Go to Schematic and click any AEC block. Choose the reference source, and the reference source changes for all AEC blocks.

MXA910, MXA920, MXA710: Route a far-end signal to the AEC Reference In channel.

IntelliMix Room: Go to Schematic and click an AEC block. Choose the reference source. Each block can use a different reference source, so set the reference for each AEC block.

Designer's Optimize workflow automatically routes an AEC reference source, but it's a good idea to check that Designer chooses the reference source you want to use.

AEC Settings

Reference Meter

Use the reference meter to visually verify the reference signal is present. The reference signal should not be clipping.

ERLE

Echo return loss enhancement (ERLE) displays the dB level of signal reduction (the amount of echo being removed). If the reference source is connected properly, the ERLE meter activity generally corresponds to the reference meter.

Reference

Indicates which channel is serving as the far end reference signal.

Non-Linear Processing

The primary component of the acoustic echo canceller is an adaptive filter. Non-linear processing supplements the adaptive filter to remove any residual echo caused by acoustic irregularities or changes in the environment. Use the lowest possible setting that is effective in your room.

Low: Use in rooms with controlled acoustics and minimal echoes. This setting provides the most natural sound for full duplex.

Medium: Use in typical rooms as a starting point. If you hear echo artifacts, try using the high setting.

High: Use to provide the strongest echo reduction in rooms with bad acoustics, or in situations where the echo path frequently changes.

Noise Reduction

Noise reduction significantly reduces the amount of background noise in your signal caused by projectors, HVAC systems, or other environmental sources. It is a dynamic processor, which calculates the noise floor in the room and removes noise throughout the entire spectrum with maximum transparency.

Settings

The noise reduction setting (low, medium, or high) represents the amount of reduction in dB. Use the lowest possible setting that effectively lowers noise in the room.

Automatic Gain Control (AGC)

Automatic gain control automatically adjusts channel levels to ensure consistent volume for all talkers, in all scenarios. For quieter voices, it increases gain; for louder voices, it attenuates the signal.

Enable AGC on channels where the distance between the talker and the microphone may vary, or in rooms where many different people will use the conferencing system.

Automatic gain control happens post-gate (after the automixer), and will not affect when the automixer gates on or off.

Target Level (dBFS)

Use -37 dBFS as a starting point to ensure adequate headroom, and adjust if necessary. This represents the RMS (average) level, which is different from setting the input fader according to peak levels to avoid clipping.

Maximum Boost (dB)

Sets the maximum amount of gain that can be applied

Maximum Cut (dB)

Sets the maximum attenuation that can be applied

Tip: Use the boost/cut meter to monitor the amount of gain added or subtracted from the signal. If this meter is always reaching the maximum boost or cut level, consider adjusting the input fader so the signal is closer to the target level.

Delay

Use delay to synchronize audio and video. When a video system introduces latency (where you hear someone speak, and their mouth moves later), add delay to align audio and video.

Delay is measured in milliseconds. If there is a significant difference between audio and video, start by using larger intervals of delay time (500-1000 ms). When the audio and video are slightly out of sync, use smaller intervals to fine-tune.

Compressor

Use the compressor to control the dynamic range of the selected signal.

Threshold

When the audio signal exceeds the threshold value, the level is attenuated to prevent unwanted spikes in the output signal. The amount of attenuation is determined by the ratio value. Perform a soundcheck and set the threshold 3-6 dB above average talker levels, so the compressor only attenuates unexpected loud sounds.

Ratio

The ratio controls how much the signal is attenuated when it exceeds the threshold value. Higher ratios provide stronger attenuation. A lower ratio of 2:1 means that for every 2 dB the signal exceeds the threshold, the output signal will only exceed the threshold by 1 dB. A higher ratio of 10:1 means a loud sound that exceeds the threshold by 10 dB will only exceed the threshold by 1 dB, effectively reducing the signal by 9 dB.

Automix

Automix Settings

Leave Last Mic On

Keeps the most recently used microphone channel active. The purpose of this feature is to keep natural room sound in the signal so that meeting participants on the far end know the audio signal has not been interrupted.

Gating Sensitivity

Changes the threshold of the level at which the gate is opened

Off Attenuation

Sets the level of signal reduction when a channel is not active

Hold Time

Sets the duration for which the channel remains open after the level drops below the gate threshold

Maximum Open Channels

Sets the maximum number of simultaneously active channels

Priority

When selected, this channel gate activates regardless of the number of maximum open channels.

Always On

When selected, this channel will always be active.

Send to Mix

When selected, sends the channel to the automix channel.

Solo

Mutes all of the other channels

Automix Gain Meter

When enabled, changes gain meters to display automix gating in real time. Channels that gate open will display more gain than channels that are closed (attenuated) in the mix.

Automix Modes

Gating

Gating mode delivers fast-acting, seamless channel gating and consistent perceived ambient sound levels. The off attenuation setting is applied to all inactive channels, regardless of the number of active channels.

Gain Sharing

Gain sharing mode dynamically balances system gain between open and closed channels. The system gain remains consistent by distributing gain across channels to equal one open channel. The scaled gain structure helps to reduce noise when there is a high channel count. When fewer channels are used, the off attenuation setting is lower and provides transparent gating.

Manual

Manual mode sums all active tracks and sends the summed signal over a single Dante output. This provides the option to route an individual signal for reinforcement or recording, without enabling automixing. The settings from the faders in the standard monitoring view apply to the summed output.

Automix Channel

This channel automatically mixes the audio from all selected channels to deliver a convenient, single output. To adjust the automix channel settings, select the IntelliMix tab. All IntelliMix DSP blocks can be applied to the automix channel.

To use the automix channel, do the following:

1. Send to Mix is automatically selected (blue) for all channels. To exclude channels from the automix channel and treat them as individual direct outputs, deselect Send to Mix (gray).
2. Route the automix channel in Dante™ Controller to the desired output.

Mute Sync

Mute sync ensures that all connected devices in a conferencing system mute or unmute at the same time and at the correct point in the signal path. Mute status is synchronized in the devices using logic signals or USB connections.

To use mute sync, make sure logic is enabled on all devices.

Designer's Optimize workflow configures all necessary mute sync settings for you.

Compatible Shure logic devices:

- P300 (Also mutes [supported soft codecs](#) connected by USB)
- ANIUSB-MATRIX (Also mutes [supported soft codecs](#) connected by USB)
- IntelliMix Room software (Also mutes [supported soft codecs](#) connected by USB)
- MXA910
- MXA710
- MXA310
- Network Mute Button
- ANI22-BLOCK
- ANI4IN-BLOCK
- Logic-enabled MX microphones connected to ANI22-BLOCK or ANI4IN-BLOCK
 - MX392
 - MX395-LED
 - MX396
 - MX405/410/415

To use mute sync, route the microphone's signal to a processor that has logic turned on (P300, ANIUSB-MATRIX, or IntelliMix Room software). Microphones always have logic turned on.

For help with specific mute sync implementations, [see our FAQs](#).

Parametric Equalizer

Maximize audio quality by adjusting the frequency response with the parametric equalizer.

Common equalizer applications:

- Improve speech intelligibility
- Reduce noise from HVAC systems or video projectors
- Reduce room irregularities
- Adjust frequency response for reinforcement systems

Setting Filter Parameters

Adjust filter settings by manipulating the icons in the frequency response graph, or by entering numeric values. Disable a filter using the check-box next to the filter.

Filter Type	<p>Only the first and last band have selectable filter types.</p> <p>Parametric: Attenuates or boosts the signal within a customizable frequency range</p> <p>Low Cut: Rolls off the audio signal below the selected frequency</p> <p>Low Shelf: Attenuates or boosts the audio signal below the selected frequency</p> <p>High Cut: Rolls off the audio signal above the selected frequency</p> <p>High Shelf: Attenuates or boosts the audio signal above the selected frequency</p>
Frequency	Select the center frequency of the filter to cut/boost
Gain	Adjusts the level for a specific filter (+/- 30 dB)

Q	Adjusts the range of frequencies affected by the filter. As this value increases, the bandwidth becomes thinner.
Width	Adjusts the range of frequencies affected by the filter. The value is represented in octaves. Note: the Q and width parameters affect the equalization curve in the same way. The only difference is the way the values are represented.

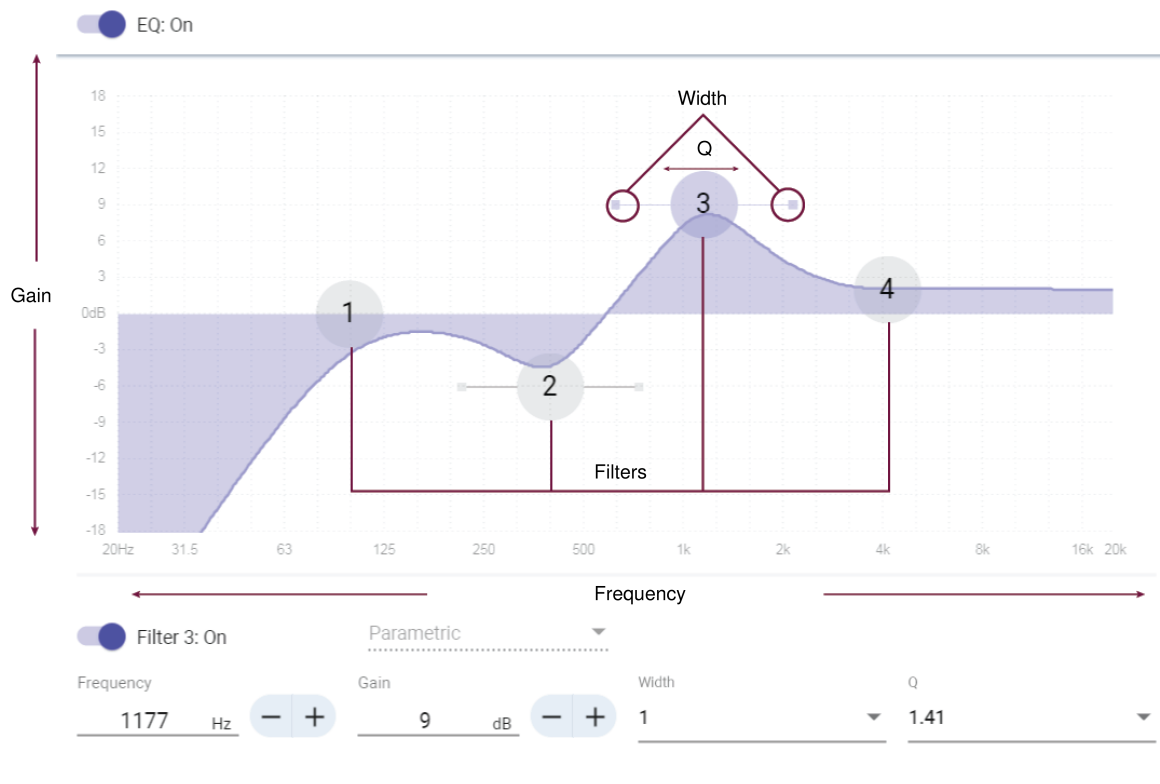

Copy, Paste, Import, and Export Equalizer Channel Settings

These features make it simple to use effective equalizer settings from a previous installation, or simply accelerate configuration time.

Copy and Paste

Use to quickly apply the same PEQ setting across multiple channels.

1. Select the channel from the pull-down menu in the PEQ screen.
2. Select Copy
3. In the pull-down menu, select the channel to apply the PEQ setting and select Paste.

Import and Export

Use to save and load PEQ settings from a file on a computer. This is useful for creating a library of reusable configuration files on computers used for system installation.

Export	Choose a channel to save the PEQ setting, and select Export to file.
Import	Choose a channel to load the PEQ setting, and select Import from file.

Equalizer Applications

Conferencing room acoustics vary based on room size, shape, and construction materials. Use the guidelines in following table.

EQ Application	Suggested Settings
Treble boost for improved speech intelligibility	Add a high shelf filter to boost frequencies greater than 1 kHz by 3-6 dB
HVAC noise reduction	Add a low cut filter to attenuate frequencies below 200 Hz
Reduce flutter echoes and sibilance	Identify the specific frequency range that "excites" the room: <ol style="list-style-type: none"> 1. Set a narrow Q value 2. Increase the gain to between +10 and +15 dB, and then experiment with frequencies between 1 kHz and 6 kHz to pinpoint the range of flutter echoes or sibilance 3. Reduce the gain at the identified frequency (start between -3 and -6 dB) to minimize the unwanted room sound
Reduce hollow, resonant room sound	Identify the specific frequency range that "excites" the room: <ol style="list-style-type: none"> 1. Set a narrow Q value 2. Increase the gain to between +10 and +15 dB, and then experiment with frequencies between 300 Hz and 900 Hz to pinpoint the resonant frequency 3. Reduce the gain at the identified frequency (start between -3 and -6 dB) to minimize the unwanted room sound

EQ Contour

Use the built-in equalizer contour to quickly apply EQ changes to all channels. The EQ contour is separate from the per-channel EQ settings. Applying both the EQ contour and per-channel EQ has a cumulative effect, meaning that the EQ changes stack on top of each other.

To use, open the microphone in Designer and click EQ contour to turn it on or off.

- **MXA710 EQ contour:** Low shelf at 300 Hz, -6 dB

Click Bypass all EQ to quickly bypass any EQ contours or channel EQ settings.

Best Practices

- Listen to and test your system as you make EQ changes, and make sure they work for your specific room.

- When using with a P300 audio conferencing processor, turn off the microphone's channel EQ and EQ contours. Use the P300 to make EQ adjustments.

Networking Best Practices

When connecting Shure devices to a network, use the following best practices:

- Always use a "star" network topology by connecting each device directly to the switch or router.
- Connect all Shure networked devices to the **same network** and set to the **same subnet**.
- Allow all Shure software through the firewall on your computer.
- Use only 1 DHCP server per network. Disable DHCP addressing on additional servers.
- Power on the switch and DHCP server before powering on the Shure devices.
- To expand the network, use multiple switches in a star topology.
- All devices must be at the same firmware revision level.

Switch and Cable Recommendations for Dante Networking

Switches and cables determine how well your audio network performs. Use high-quality switches and cables to make your audio network more reliable.

Network switches should have:

- Gigabit ports. 10/100 switches may work on small networks, but gigabit switches perform better.
- Power over Ethernet (PoE) or PoE+ ports for any devices that require power
- Management features to provide information about port speed, error counters, and bandwidth used
- Ability to switch off Energy Efficient Ethernet (EEE). EEE (also known as "Green Ethernet") may cause audio dropouts and problems with clock synchronization.
- Diffserv (DSCP) Quality of Service (QoS) with strict priority and 4 queues

Ethernet cables should be:

- Cat5e or better
- Shielded

For more information, [see our FAQ](#) about switches to avoid.

Setting Latency

Latency is the amount of time for a signal to travel across the system to the outputs of a device. To account for variances in latency time between devices and channels, Dante has a predetermined selection of latency settings. When the same setting is selected, it ensures that all Dante devices on the network are in sync.

These latency values should be used as a starting point. To determine the exact latency to use for your setup, deploy the setup, send Dante audio between your devices, and measure the actual latency in your system using Audinate's Dante Controller software. Then round up to the nearest latency setting available, and use that one.

Use Audinate's Dante Controller software to change latency settings.

Latency Recommendations

Latency Setting	Maximum Number of Switches
0.25 ms	3
0.5 ms (default)	5

Latency Setting	Maximum Number of Switches
1 ms	10
2 ms	10+

Device IP Configuration

This Shure device uses 2 IP addresses: one for Shure control, and one for Dante audio and control.

- **Shure control**
 - Carries data for Shure control software, firmware updates, and third-party control systems (such as AMX or Crestron)
- **Dante audio and control**
 - Carries Dante digital audio and control data for Dante Controller
 - Requires a wired, gigabit Ethernet connection to operate

To access these settings in Designer, go to [Your device] > Settings > IP configuration.

QoS (Quality of Service) Settings

QoS settings assign priorities to specific data packets on the network, ensuring reliable audio delivery on larger networks with heavy traffic. This feature is available on most managed network switches. Although not required, assigning QoS settings is recommended.

Note: Coordinate changes with the network administrator to avoid disrupting service.

To assign QoS values, open the switch interface and use the following table to assign Dante[®]-associated queue values.

- Assign the highest possible value (shown as 4 in this example) for time-critical PTP events
- Use descending priority values for each remaining packet.

Dante QoS Priority Values

Priority	Usage	DSCP Label	Hex	Decimal	Binary
High (4)	Time-critical PTP events	CS7	0x38	56	111000
Medium (3)	Audio, PTP	EF	0x2E	46	101110
Low (2)	(reserved)	CS1	0x08	8	001000
None (1)	Other traffic	BestEffort	0x00	0	000000

Note: Switch management may vary by manufacturer and switch type. Consult the manufacturer's product guide for specific configuration details.

For more information on Dante requirements and networking, visit www.audinate.com.

Networking Terminology

PTP (Precision Time Protocol): Used to synchronize clocks on the network

DSCP (Differentiated Services Code Point): Standardized identification method for data used in layer 3 QoS prioritization

Digital Audio Networking

Dante digital audio is carried over standard Ethernet and operates using standard internet protocols. Dante provides low latency, tight clock synchronization, and high Quality-of-Service (QoS) to provide reliable audio transport to a variety of Dante devices. Dante audio can coexist safely on the same network as IT and control data, or can be configured to use a dedicated network.

Compatibility with Dante Domain Manager

This device is compatible with Dante Domain Manager software (DDM). DDM is network management software with user authentication, role-based security, and auditing features for Dante networks and Dante-enabled products.

Considerations for Shure devices controlled by DDM:

- When you add Shure devices to a Dante domain, set the local controller access to Read Write. Otherwise, you won't be able to access to Dante settings, perform a factory reset, or update device firmware.
- If the device and DDM can't communicate over the network for any reason, you won't be able to control Dante settings, perform a factory reset, or update device firmware. When the connection is reestablished, the device follows the policy set for it in the Dante domain.
- If Dante device lock is on, DDM is offline, or the configuration of the device is set to Prevent, some device settings are disabled. These include: Dante encryption, MXW association, AD4 Dante browse and Dante cue, and SCM820 linking.

See [Dante Domain Manager's documentation](#) for more information.

Dante Flows for Shure Devices

Dante flows get created any time you route audio from one Dante device to another. One Dante flow can contain up to 4 audio channels. For example: sending all 5 available channels from an MXA310 to another device uses 2 Dante flows, because 1 flow can contain up to 4 channels.

Every Dante device has a specific number of transmit flows and receive flows. The number of flows is determined by Dante platform capabilities.

Unicast and multicast transmission settings also affect the number of Dante flows a device can send or receive. Using multicast transmission can help overcome unicast flow limitations.

Shure devices use different Dante platforms:

Dante Platform	Shure Devices Using Platform	Unicast Transmit Flow Limit	Unicast Receive Flow Limit
Brooklyn II	ULX-D, SCM820, MXWAPT, MXWANI, P300, MXCWAPT	32	32
Brooklyn II (without SRAM)	MXA920, MXA910, MXA710, AD4	16	16
Ultimo/UltimoX	MXA310, ANI4IN, ANI4OUT, ANIUSB-MATRIX, ANI22, MXN5-C	2	2
DAL	IntelliMix Room	16	16

[Learn more about Dante flows in our FAQs](#) or from [Audinate](#).

AES67

AES67 is a networked audio standard that enables communication between hardware components which use different IP audio technologies. This Shure device supports AES67 for increased compatibility within networked systems for live sound, integrated installations, and broadcast applications.

The following information is critical when transmitting or receiving AES67 signals:

- Update Dante Controller software to the newest available version to ensure the AES67 configuration tab appears.
- Before turning encryption on or off, you must disable AES67 in Dante Controller.
- AES67 cannot operate when the transmit and receive devices both support Dante.

Shure Device Supports:	Device 2 Supports:	AES67 Compatibility
Dante and AES67	Dante and AES67	No. Must use Dante.
Dante and AES67	AES67 without Dante. Any other audio networking protocol is acceptable.	Yes

Separate Dante and AES67 flows can operate simultaneously. The total number of flows is determined by the maximum flow limit of the device.

Sending Audio from a Shure Device

All AES67 configuration is managed in Dante Controller software. For more information, refer to the Dante Controller user guide.

1. Open the Shure transmitting device in Dante Controller.
2. Enable AES67.
3. Reboot the Shure device.
4. Create AES67 flows according to the instructions in the [Dante Controller user guide](#).

Receiving Audio from a Device Using a Different Audio Network Protocol

Third-party devices: When the hardware supports SAP, flows are identified in the routing software that the device uses. Otherwise, to receive an AES67 flow, the AES67 session ID and IP address are required.

Shure devices: The transmitting device must support SAP. In Dante Controller, a transmit device (appears as an IP address) can be routed like any other Dante device.

IP Ports and Protocols

Shure Control

Port	TCP/UDP	Protocol	Description	Factory Default
21	TCP	FTP	Required for firmware updates (otherwise closed)	Closed
22	TCP	SSH	Secure Shell Interface	Closed
23	TCP	Telnet	Not supported	Closed
53	UDP	DNS	Domain Name System	Closed

Port	TCP/UDP	Protocol	Description	Factory Default
67	UDP	DHCP	Dynamic Host Configuration Protocol	Open
68	UDP	DHCP	Dynamic Host Configuration Protocol	Open
80*	TCP	HTTP	Required to launch embedded web server	Open
443	TCP	HTTPS	Not supported	Closed
2202	TCP	ASCII	Required for 3rd party control strings	Open
5353	UDP	mDNS [†]	Required for device discovery	Open
5568	UDP	SDT (multicast) [†]	Required for inter-device communication	Open
57383	UDP	SDT (unicast)	Required for inter-device communication	Open
8023	TCP	Telnet	Debug console interface	Closed
8180	TCP	HTML	Required for web application (legacy firmware only)	Open
8427	UDP	SLP (multicast) [†]	Required for inter-device communication	Open
64000	TCP	Telnet	Required for Shure firmware update	Open

*These ports must be open on the PC or control system to access the device through a firewall.

[†]These protocols require multicast. Ensure multicast has been correctly configured for your network.

See [Audinate's website](#) for information about ports and protocols used by Dante audio.

Using Command Strings

This device receives logic commands over the network. Many parameters controlled through Designer can be controlled using a third-party control system, using the appropriate command string.

Common applications:

- Mute
- LED color and behavior
- Loading presets
- Adjusting levels

A complete list of command strings is available at:

pubs.shure.com/command-strings/MXA710.

Optional Accessories

- [A710-FM-2FT Flush Mount Kit](#)
- [A710-FM-4FT Flush Mount Kit](#)
- [A710B-DS Desk Stand \(black\)](#)

- [A710AL-DS Desk Stand \(aluminum\)](#)
- [A710-TB Tile Bridge](#)
- [A710-MSA Mic Stand Adapter](#)
- [A710B-2FT-HOUSING \(black\)](#)
- [A710W-2FT-HOUSING \(white\)](#)
- [A710AL-2FT-HOUSING \(aluminum\)](#)
- [A710B-4FT-HOUSING \(black\)](#)
- [A710W-4FT-HOUSING \(white\)](#)
- [A710AL-4FT-HOUSING \(aluminum\)](#)

Specifications

All specifications measured from narrow lobe width. Values for all widths are within ± 3 dB of these specifications unless otherwise noted.

General

Lobe Width

Adjustable	Narrow	30 degrees
	Medium	40 degrees
	Wide	70 degrees

Connector Type

RJ45

Power Requirements

Power over Ethernet (PoE), Class 0

Power Consumption

10 W maximum

Weight

MXA710-2FT	2 lbs (0.91 kg)
MXA710-4FT	3.7 lbs (1.67 kg)

Product Dimensions

MXA710-2FT	0.87 x 2.36 x 25.04 in. (22.09 x 60 x 636 mm) H x W x L
MXA710-4FT	0.87 x 2.36 x 49.12 in. (22.09 x 60 x 1247.76 mm) H x W x L

Control Software

Shure Designer

Plenum Rating

UL2043 (Suitable for Air Handling Spaces)

Dust Protection

IEC 60529 IP5X Dust Protected

Operating Temperature Range

-6.7°C (20°F) to 40°C (104°F)

Storage Temperature Range

-29°C (-20°F) to 74°C (165°F)

Audio

Frequency Response

100 Hz to 20 kHz

AES67 or Dante Digital Output

Chan- nel Count	MXA710-2FT	6 total channels (4 independent transmit channels, 1 Automix output, 1 AEC reference in channel)
	MXA710-4FT	10 total channels (8 independent transmit channels, 1 Automix output, 1 AEC reference in channel)
Sampling Rate		48 kHz
Bit Depth		24

Sensitivity

at 1 kHz

MXA710-2FT	-7.4 dBFS/Pa
MXA710-4FT	-7.9 dBFS/Pa

Maximum SPL

Relative to 0 dBFS overload

MXA710-2FT	101.4 dB SPL
MXA710-4FT	101.9 dB SPL

Signal-To-Noise Ratio

Ref. 94 dB SPL at 1 kHz

71.2 dB A-weighted

Latency

Does not include Dante latency

Direct Outputs	8.7 ms
Automix output (Includes IntelliMix processing)	19.3 ms

Self Noise

MXA710-2FT	22.9 dB SPL-A
MXA710-4FT	22.8 dB SPL-A

Dynamic Range

MXA710-2FT	78.5 dB
MXA710-4FT	79.1 dB

Built-in Digital Signal Processing

Automatic mixing, Acoustic Echo Cancellation (AEC), Noise Reduction, Automatic Gain Control, Compressor, Delay, Equalizer (4-band Parametric) , Mute, Gain (140 dB range)

Acoustic Echo Cancellation Tail Length

Up to 250 ms

Networking

Cable Requirements

Cat 5e or higher (shielded cable recommended)

MXA710 Frequency Response

Frequency response measured directly on-axis from a distance of 6 feet (1.83 m).

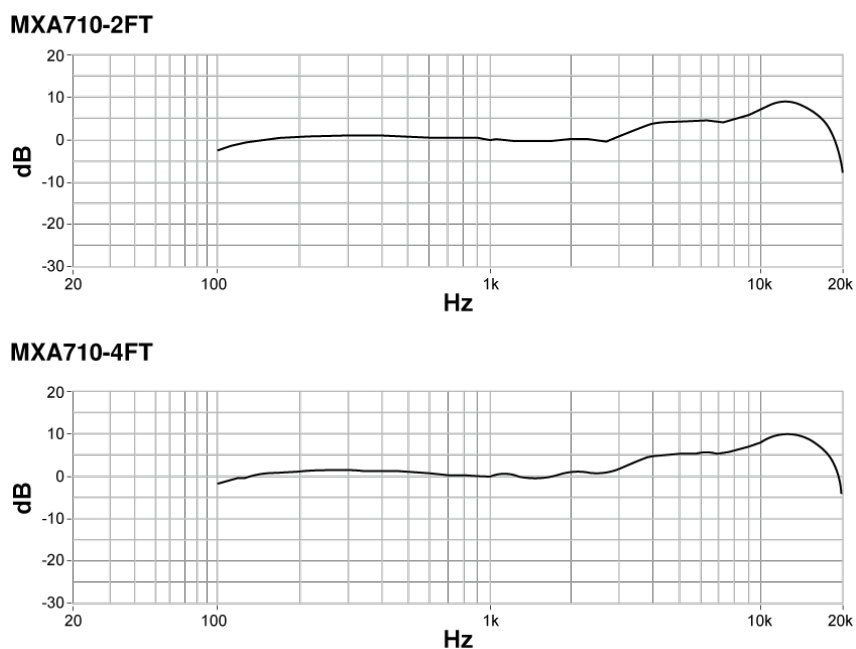

Lobe Sensitivity

The edge of the blue coverage area for each channel represents where the sensitivity reaches -6 dB. Understanding how lobe sensitivity is displayed helps to:

- Provide complete coverage in a space, either by adding lobes or changing the lobe width. This ensures the sensitivity is within 6 dB in all areas. It is acceptable for lobes to slightly overlap.
- Ensure that spacing and isolation are adequate to reduce noise and maximize automatic mixing performance.

Wall Horizontal Installation (Top View)

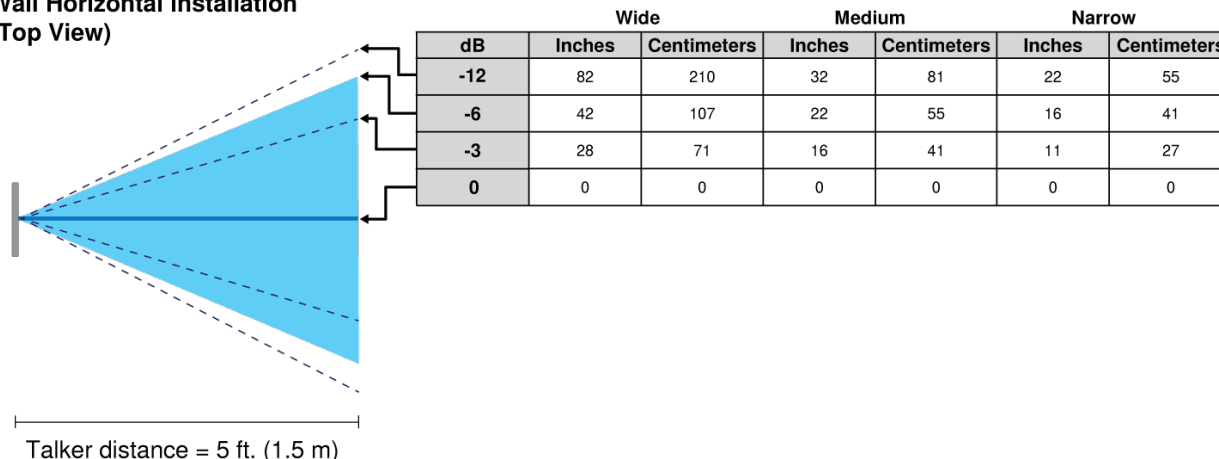

Measured at 1 kHz, on-axis

Contact Customer Support

Didn't find what you need? [Contact our customer support](#) to get help.

IMPORTANT SAFETY INSTRUCTIONS

1. READ these instructions.
2. KEEP these instructions.
3. HEED all warnings.
4. FOLLOW all instructions.
5. DO NOT use this apparatus near water.
6. CLEAN ONLY with dry cloth.
7. DO NOT block any ventilation openings. Allow sufficient distances for adequate ventilation and install in accordance with the manufacturer's instructions.
8. DO NOT install near any heat sources such as open flames, radiators, heat registers, stoves, or other apparatus (including amplifiers) that produce heat. Do not place any open flame sources on the product.
9. DO NOT defeat the safety purpose of the polarized or grounding type plug. A polarized plug has two blades with one wider than the other. A grounding type plug has two blades and a third grounding prong. The wider blade or the third prong are provided for your safety. If the provided plug does not fit into your outlet, consult an electrician for replacement of the obsolete outlet.
10. PROTECT the power cord from being walked on or pinched, particularly at plugs, convenience receptacles, and the point where they exit from the apparatus.
11. ONLY USE attachments/accessories specified by the manufacturer.
12. USE only with a cart, stand, tripod, bracket, or table specified by the manufacturer, or sold with the apparatus. When a cart is used, use caution when moving the cart/apparatus combination to avoid injury from tip-over.



13. UNPLUG this apparatus during lightning storms or when unused for long periods of time.
14. REFER all servicing to qualified service personnel. Servicing is required when the apparatus has been damaged in any way, such as power supply cord or plug is damaged, liquid has been spilled or objects have fallen into the apparatus, the apparatus has been exposed to rain or moisture, does not operate normally, or has been dropped.
15. DO NOT expose the apparatus to dripping and splashing. DO NOT put objects filled with liquids, such as vases, on the apparatus.
16. The MAINS plug or an appliance coupler shall remain readily operable.
17. The airborne noise of the Apparatus does not exceed 70dB (A).
18. Apparatus with CLASS I construction shall be connected to a MAINS socket outlet with a protective earthing connection.
19. To reduce the risk of fire or electric shock, do not expose this apparatus to rain or moisture.
20. Do not attempt to modify this product. Doing so could result in personal injury and/or product failure.
21. Operate this product within its specified operating temperature range.

	This symbol indicates that dangerous voltage constituting a risk of electric shock is present within this unit.
	This symbol indicates that there are important operating and maintenance instructions in the literature accompanying this unit.

Important Product Information

The equipment is intended to be used in professional audio applications.

Note: This device is not intended to be connected directly to a public internet network.

EMC conformance to Environment E2: Commercial and Light Industrial. Testing is based on the use of supplied and recommended cable types. The use of other than shielded (screened) cable types may degrade EMC performance.

Changes or modifications not expressly approved by Shure Incorporated could void your authority to operate this equipment.

Industry Canada ICES-003 Compliance Label: CAN ICES-3 (B)/NMB-3(B)

Authorized under the verification provision of FCC Part 15B.

Please follow your regional recycling scheme for batteries, packaging, and electronic waste.

Dante is a registered trademark of Audinate Pty Ltd.

Information to the user

This equipment has been tested and found to comply with the limits for a Class B digital device, pursuant to part 15 of the FCC Rules. This equipment generates, uses, and can radiate radio frequency energy and, if not installed and used in accordance with the manufacturer's instruction manual, may cause interference with radio and television reception.

Notice: The FCC regulations provide that changes or modifications not expressly approved by Shure Incorporated could void your authority to operate this equipment.

These limits are designed to provide reasonable protection against harmful interference in a residential installation. This equipment generates, uses, and can radiate radio frequency energy and, if not installed and used in accordance with the instructions, may cause harmful interference to radio communications. However, there is no guarantee that interference will not occur in a particular installation. If this equipment does cause harmful interference to radio or television reception, which can be determined by turning the equipment off and on, the user is encouraged to try to correct the interference by one or more of the following measures:

- Reorient or relocate the receiving antenna.
- Increase the separation between the equipment and the receiver.
- Connect the equipment to an outlet on a circuit different from that to which the receiver is connected.
- Consult the dealer or an experienced radio/TV technician for help.

This device complies with part 15 of the FCC Rules. Operation is subject to the following two conditions:

1. This device may not cause harmful interference.
2. This device must accept any interference received, including interference that may cause undesired operation.

The CE Declaration of Conformity can be obtained from: www.shure.com/europe/compliance

Authorized European representative:

Shure Europe GmbH
Global Compliance
Jakob-Dieffenbacher-Str. 12
75031 Eppingen, Germany
Phone: +49-7262-92 49 0
Email: info@shure.de
www.shure.com

This product meets the Essential Requirements of all relevant European directives and is eligible for CE marking.

The CE Declaration of Conformity can be obtained from Shure Incorporated or any of its European representatives. For contact information please visit www.shure.com