



XS Wireless IEM

Instruction Manual (PDF export of the original HTML manual)

This PDF document is a PDF export of an interactive manual in HTML format.

When displayed in PDF format, it is possible that not all content and interactive elements in the HTML instructions are included, as these cannot be displayed in PDF format.

We recommend using the complete and interactive HTML instructions.

You can find these in the Sennheiser Documentation App, which is available free of charge for iOS and Android. Alternatively, the HTML instructions are also available in the download area of the product page:

www.sennheiser.com/xsw-iem

Sennheiser electronic GmbH & Co. KG

SENNHEISER

Am Labor 1, 30900 Wedemark, Germany, www.sennheiser.com
XS Wireless IEM - v1.0, 02/2022



PRODUCT INFORMATION

This manual contains information on the individual products in the XSW IEM series, the available accessories and the frequency bank system.



XSW IEM series products

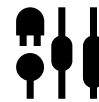

Accessories



The frequency bank system



XSW IEM series products

The XSW IEM series of products includes the rack-mounted XSW IEM SR transmitter in a sturdy metal housing, the lightweight XSW IEM EK bodypack receiver, and the IE 4 in-ear monitoring headphones with natural sound and excellent protection against background noise.



XSW IEM SR – stereo transmitter



XSW IEM EK – bodypack receiver

XSW IEM SR – stereo transmitter



The XSW IEM SR is a sturdy stereo transmitter for in-ear monitoring with half-rack width, all-metal housing and a high-contrast LC display. The stereo transmitter is designed for interference-free operation with the wireless microphones of the XS Wireless series.

- ▷ Starting up the XSW IEM SR
- ▷ Using the XSW IEM SR
- ▷ Specifications of XSW IEM SR



XSW IEM EK – bodypack receiver



The XSW IEM EK is a sturdy bodypack receiver for in-ear monitoring with reliable IE 4 in-ear monitoring earphones. The receiver has an infrared connection for easy and versatile synchronization with the XSW IEM transmitter.

- ▷ Starting up the XSW IEM EK
- ▷ Using the XSW IEM EK
- ▷ Specifications of XSW IEM SR



Accessories

A variety of accessories are available for the XSW IEM series.

Earphones

IE 4

Art. no. 500432



Earphones for use with wireless monitor systems. The IE 4 feature excellent sound and dynamic range. They have interchangeable earpieces to fit different sized ear canals. This provides good insulation against background noise and exceptionally good bass response for this type of receiver.

Removable earpieces in three different sizes for universal fit

- Natural sound and dynamic range
- Extremely resilient at high sound pressures
- Superior bass response
- Sturdy cable



Other compatible earphones

IE 100 PRO



For the demanding requirements of the live stage: With a newly developed dynamic driver, the IE 100 PRO guarantees precise acoustic reproduction for live sessions and sets. The innovative new membrane delivers powerful, warm and detail-rich sound. Every detail remains undistorted and clear, even at the highest levels. Because of its exceptional sound and unmatched comfort, musicians and DJs choose the IE 100 PRO for live sessions, for producing and for everyday listening.

The in-ear earphones fit any ear shape. Their low-profile, compact design ensures a secure fit and unmatched comfort. They have a sturdy, stage-proof design, from the connector to the cable sheath.

- Newly developed 10 mm dynamic wideband transducer for powerful, accurate monitoring sound
- Dynamic driver system delivers homogeneous and distortion-free sound for less strain on the listener
- Secure fit, unmatched comfort: new low-profile and ergonomic design
- Optimized earpiece shape and flexible silicone and foam attachments for excellent protection against background noise
- Stage-proof cable connection



IE 400 PRO



The warm sound and rich punch of the IE 400 PRO in-ear monitors make them the right choice for professionals who want studio-quality sound on the stage. The IE 400 PRO delivers warm sound without artifacts or distortion even at high sound pressure levels.

With newly developed TrueResponse technology, the 7 mm dynamic driver delivers outstanding resolution and reduces strain on the listener, even over long periods of time. The distortions, overlapping frequencies and resonance peaks common in other headphones are now a thing of the past.

The total harmonic distortion has been reduced to a previously unthinkable 0.08%. The earphones also have an ultra compact design, which can be tailored to any ear shape using the included silicone and memory foam adapters. Easy to use, brilliant sound, sturdy even under extreme conditions, and comfortable in the ear canal even after hours of listening.

- Newly developed 7 mm dynamic wideband transducer for powerful, high-resolution monitoring sound
- Noticeable punch with transparent midranges and clear highs
- TrueResponse driver system delivers homogeneous and low-distortion sound for less strain on the listener
- Compact, ergonomic housing provides excellent comfort and good fit
- Optimized earpiece shape and flexible silicone and foam attachments for unmatched protection against background noise
- Stage-proof cable concept with innovative new sheath (patent pending)



IE 500 PRO



High-resolution sound down to the finest details and precise imaging, even at extreme sound pressure levels: the low impedance IE 500 PRO combines enormous power with unmatched clarity for any venue or stage in the world. The double-stranded cable allows it to handle extremely high volumes. The dynamic 7 mm driver uses newly developed TrueResponse technology to enable audio professionals to control even the smallest details. This technology reinforces the natural strengths of the membrane and eliminates the listening strain caused by other driver systems. Distortion, resonance peaks and overlapping frequency ranges are a thing of the past.

The total harmonic distortion has been reduced to a previously unthinkable 0.08%. The miniaturized design also allows for a previously unthinkable low-profile shape that fits comfortably and securely into any ear canal. The included silicone and memory foam adapters improve fit and protect against background noise, so that the earphones feel almost custom made.

The IE 500 PRO sits securely in your ear, even if you make sharp movements—while still being easy enough to insert or remove in seconds. And the innovative, unbreakable cable sheath (patent pending) is designed to be completely replaceable.

- Newly developed 7 mm dynamic wideband transducer with extremely fine resolution and neutral sound image
- Detachable, double-stranded cable provides excellent absorption of impact noise
- TrueResponse driver system delivers homogeneous and low-distortion sound for less strain on the listener
- Compact, ergonomic housing provides excellent comfort and good fit
- Optimized eartip shape and flexible silicone and foam attachments for unmatched protection against background



noise

- Stage-proof cable concept with innovative new sheath (patent pending)



Antennas

BNC antenna

Art. no. 522419



Power supply unit

NT 12-5-CW

Art. no. 507352

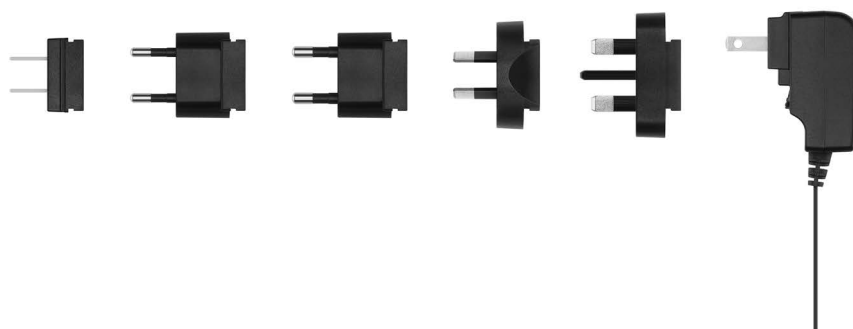

Power supply unit for the XSW 1, XSW 2, XSW IEM and ew G4 100 series. All adapters included (EU, US, UK, Korea, Australia, China).



Mounting hardware

XSW Rack Mount Kit

Art. no. 507351



Rack mount kit for XSW IEM and XSW 2

Antenna front mount kit for XSW IEM

Art. no. 507468



Antenna front mount kit for installing antenna connectors on the front of the rack when using an XSW IEM together with the XSW rack mount kit



Receiver accessories

XSW IEM belt clip

Art. no. 592582

Belt clip for the XSW IEM EK receiver with two plastic fasteners.

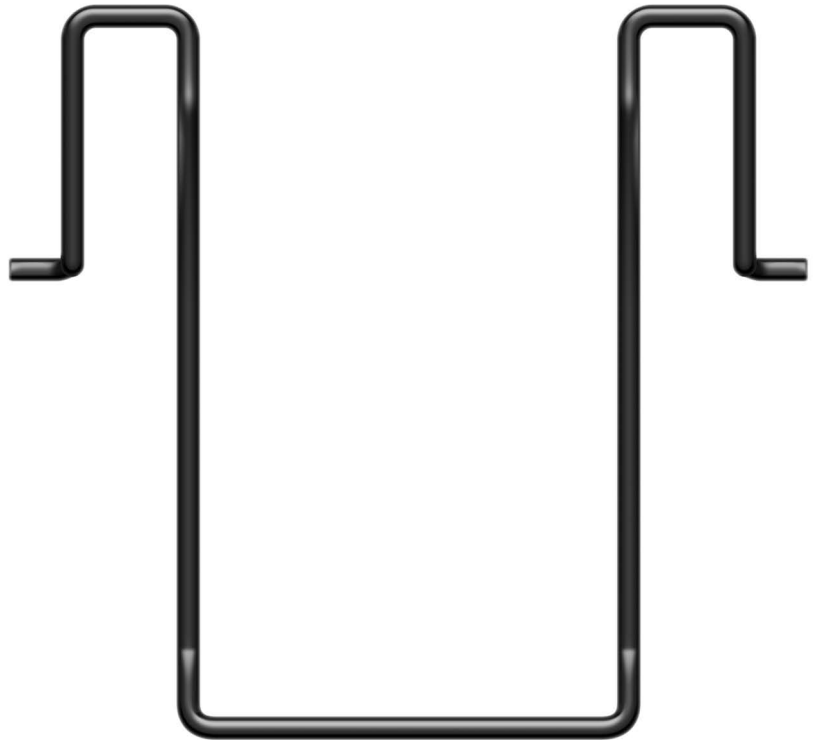



The frequency bank system

There are different frequency ranges in the UHF band available for transmission.

There may be special conditions and restrictions for using frequencies in your country. Before starting up the product, find the information for your country at the following address: www.sennheiser.com/sifa

Please note the country-specific frequency ranges of public and private TV stations. Depending on where the transmitter is used, you are likely to find frequencies within the following channel banks:

- Europe: channel banks 5 – 8
- America: channel banks 1 – 4

The following frequency ranges can be used in the various countries:

EU

A	B	C	E	K
476-500	572-596	662-686	823.2-831.8	925.2-937.3
✓	✓	✓	✓	

UK

A	B	C	E	K
476-500	572-596	662-686	823.2-831.8	925.2-937.3
✓	✓	✓	✓	

USA/CANADA

A	B	C	E	K
476-500	572-596	662-686	823.2-831.8	925.2-937.3
✓	✓			



BRAZIL

A	B	C	E	K
476-500	572-596	662-686	823.2-831.8	925.2-937.3

✓	✓	✓		
---	---	---	--	--

CHINA

A	B	C	E	K
476-500	572-596	662-686	823.2-831.8	925.2-937.3

✓		✓		
---	--	---	--	--

SINGAPORE

A	B	C	E	K
476-500	572-596	662-686	823.2-831.8	925.2-937.3

✓	✓	✓		
---	---	---	--	--

PHILIPPINES

A	B	C	E	K
476-500	572-596	662-686	823.2-831.8	925.2-937.3

✓	✓	✓		
---	---	---	--	--

MALAYSIA

A	B	C	E	K
476-500	572-596	662-686	823.2-831.8	925.2-937.3

✓	✓	✓		
---	---	---	--	--

**ISRAEL**

A	B	C	E	K
476-500	572-596	662-686	823.2-831.8	925.2-937.3

✓	✓	✓	✓	
---	---	---	---	--

QATAR

A	B	C	E	K
476-500	572-596	662-686	823.2-831.8	925.2-937.3

✓	✓	✓	✓	
---	---	---	---	--

UNITED ARAB EMIRATES

A	B	C	E	K
476-500	572-596	662-686	823.2-831.8	925.2-937.3

✓	✓	✓		
---	---	---	--	--

SAUDI ARABIA

A	B	C	E	K
476-500	572-596	662-686	823.2-831.8	925.2-937.3

✓	✓	✓	✓	
---	---	---	---	--

AUSTRALIA

A	B	C	E	K
476-500	572-596	662-686	823.2-831.8	925.2-937.3

	✓	✓		
--	---	---	--	--



NEW ZEALAND

A	B	C	E	K
476-500	572-596	662-686	823.2-831.8	925.2-937.3

✓ ✓

RUSSIA

A	B	C	E	K
476-500	572-596	662-686	823.2-831.8	925.2-937.3

✓

INDONESIA

A	B	C	E	K
476-500	572-596	662-686	823.2-831.8	925.2-937.3

✓ ✓

VIETNAM

A	B	C	E	K
476-500	572-596	662-686	823.2-831.8	925.2-937.3

✓

SOUTH KOREA

A	B	C	E	K
476-500	572-596	662-686	823.2-831.8	925.2-937.3

✓



INSTRUCTION MANUAL

Starting up and using the devices



Starting up the devices



Using the devices



Establishing a radio link



Synchronizing devices



Cleaning and maintaining the devices



Starting up the devices

You can find information about installing and connecting XSW IEM series devices in the following sections.



Starting up the XSW IEM SR



Starting up the XSW IEM EK



Starting up the XSW IEM SR

Connectors on the rear of the device

XSW IEM SR rear side product overview

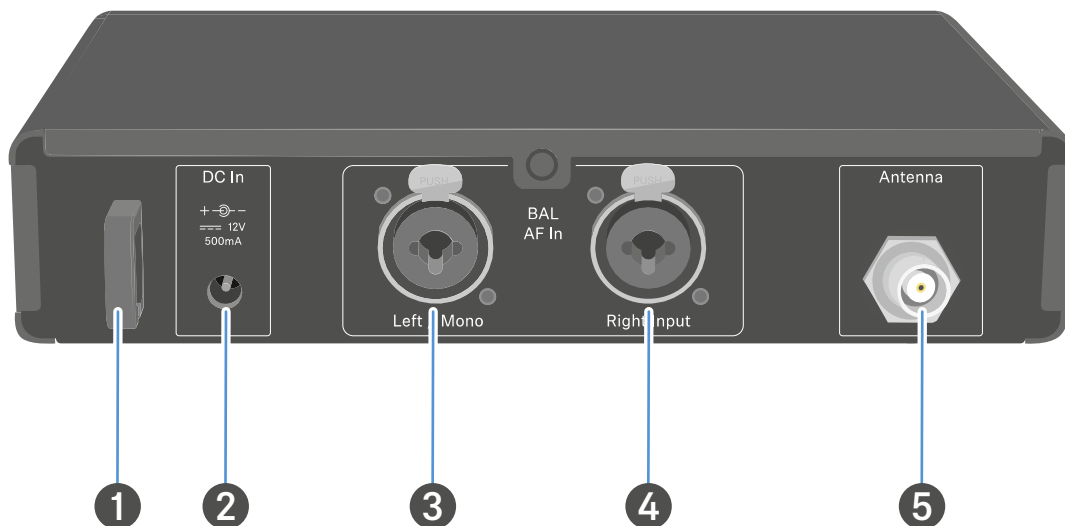

1 Strain relief for the connection cable of the power supply unit

- See Connecting/disconnecting the XSW IEM SR with/from the power supply

2 DC In socket

- For connecting the power supply unit
- See Connecting/disconnecting the XSW IEM SR with/from the power supply

3 BAL AF In L XLR-3/6.3 mm jack combo socket

- Audio input, left
- See Connecting audio signals

4 BAL AF In R XLR-3/6.3 mm jack combo socket

- Audio input, right
- See Connecting audio signals

5 Antenna BNC socket

- Antenna output with remote feed input
- See Connecting rod antennas



Connecting/disconnecting the XSW IEM SR with/from the power supply

Only use the supplied power supply unit. It is designed for your transmitter and ensures safe operation. You can find the suitable power supply unit under Accessories.

To connect the XSW IEM SR transmitter to the power supply:

- ▷ Insert the plug of the power supply unit into the DC IN socket of the receiver.
- ▷ Pass the cable of the power supply unit through the strain relief.
- ▷ Slide the supplied country adapter onto the power supply unit.
- ▷ Plug the power supply unit into the wall socket.

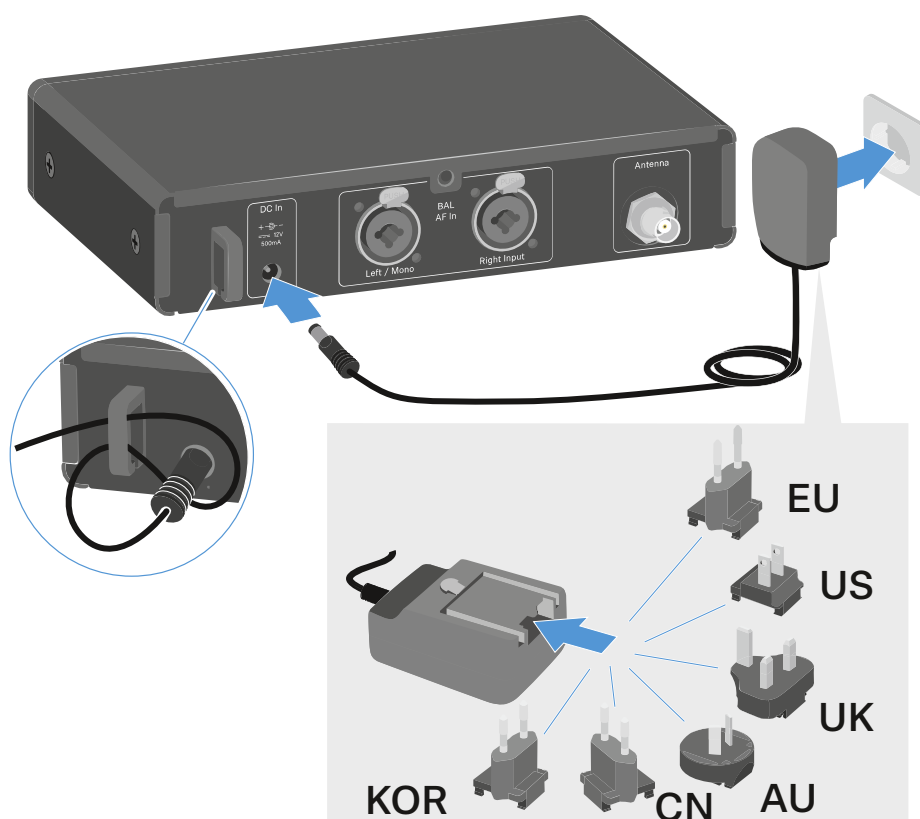

To disconnect the XSW IEM SR transmitter from the power supply:

- ▷ Unplug the power supply unit from the wall socket.
- ▷ Unplug the power supply unit from the **DC IN** socket of the receiver.



Connecting audio signals

You can connect two mixed mono signals using the two input jacks **Left/Mono** and **Right Input**.

To do so, the XSW IEM SR must be configured for Mono or Stereo operation in the **AUDIO** menu. See Configuring the audio transmission mode (mono/stereo)

In stereo mode, you can receive the two input signals either as a mixed mono signal or as a stereo signal. To do this, set the **FOCUS** setting on the XSW IEM EK receiver to **ON** or **OFF** (see Setting the FOCUS).

Mono

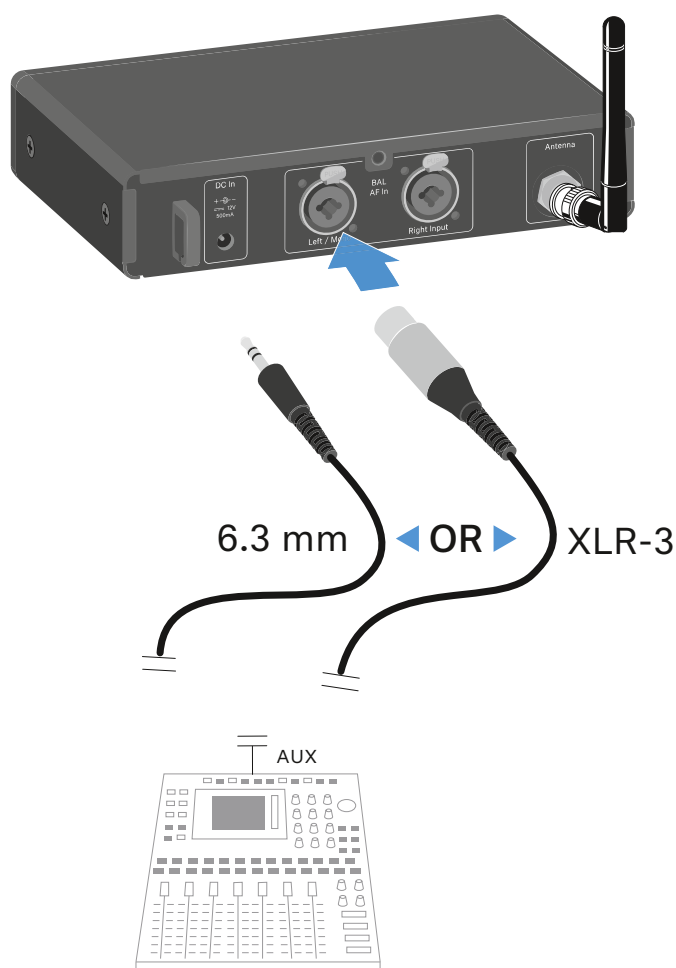

- ▷ Connect the output of an external device (e.g. a mixing console or another XSW IEM SR) to the audio input socket **BAL AF In L + Left/Mono** using a suitable cable.

In mono mode, the **FOCUS** setting on the XSW IEM EK receiver has no function (see Setting the FOCUS).



Stereo

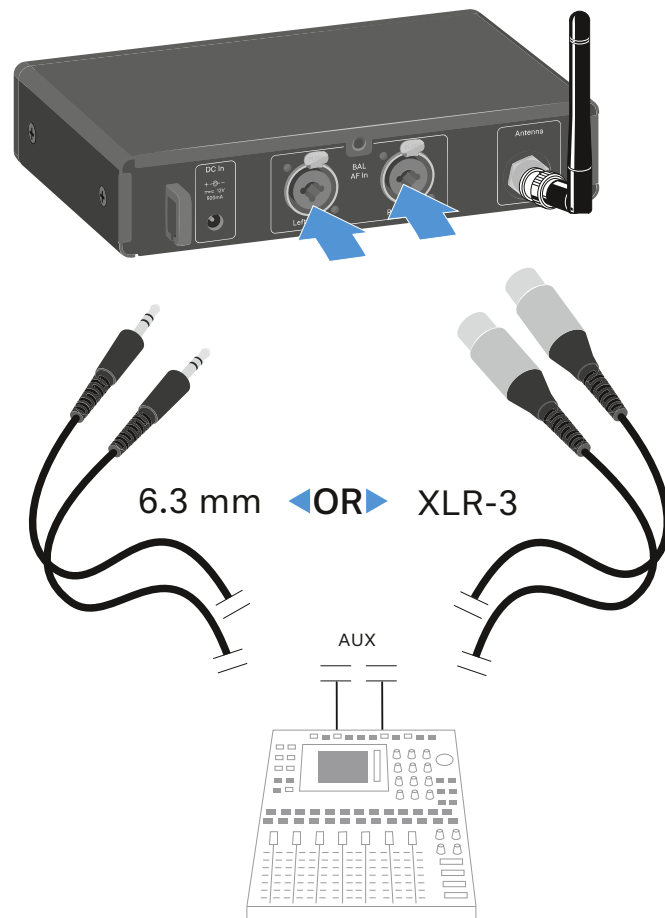

- ▶ Connect the output of an external device (e.g. a mixing console or another XSW IEM SR) to the audio input sockets **BAL AF In Left/Mono** and **BAL AF In Right Input** using suitable cables.

In stereo mode, the corresponding XSW IEM EK receiver can be operated in Focus mode or Stereo mode (see Setting the FOCUS).



Connecting rod antennas

To connect the supplied rod antenna:

- ▷ Connect the rod antenna to the **Antenna** socket on the rear side of the XSW IEM SR.

Animation: “Connecting the rod antenna”

Here, the original HTML instructions include an animated illustration which is not supported by the PDF format.

Open the HTML instructions in the Sennheiser Documentation App or on the Sennheiser website to display the animation:

https://www.sennheiser-sites.com/responsive-manuals/XSW_IEM/EN/index.html

For more information on mounting antennas on a rack mount rail, see Installing the XSW IEM SR in a rack.



Installing the XSW IEM SR in a rack

Caution!

Rack mounting poses risks

When installing the device in a closed 19" rack or multi-rack assembly, please consider that, during operation, the ambient temperature, the mechanical load and the electrical potentials will be different from those of devices which are not mounted into a rack.

- ▷ Make sure that the ambient temperature within the rack does not exceed the permissible temperature limit stated in the specifications. See Specifications of XSW IEM SR.
- ▷ Ensure sufficient ventilation; if necessary, provide additional ventilation.
- ▷ Make sure that the mechanical load of the rack is even.
- ▷ When connecting to the power supply system, observe the information indicated on the type plate. Avoid overloading the circuits. If necessary, provide overcurrent protection.
- ▷ When mounting in a rack, please note that intrinsically harmless leakage currents of the individual power supply units may accumulate, thereby exceeding the permissible limit value. As a remedy, ground the rack via an additional ground connection.

Mounting a single transmitter in a rack

To mount the transmitter in a rack, you will need the GA 1-XSW 2 rack mount kit (see Mounting hardware).

To fasten the mounting bracket of the rack mount kit:

- ▷ Unscrew and remove the two recessed head screws (M4x8) on each side of the transmitter.
- ▷ Secure the left and right mounting brackets to the sides of the transmitter using the previously removed recessed head screws.



Here, the original HTML instructions include an animated illustration which is not supported by the PDF format.

Open the HTML instructions in the Sennheiser Documentation App or on the Sennheiser website to display the animation:

https://www.sennheiser-sites.com/responsive-manuals/XSW_IEM/EN/index.html

To attach the blanking plate to one of the mounting brackets of the rack mount kit:

- ▷ Secure the blanking plate to one of the two mounting brackets using two recessed head screws (M6x10).

Here, the original HTML instructions include an animated illustration which is not supported by the PDF format.

Open the HTML instructions in the Sennheiser Documentation App or on the Sennheiser website to display the animation:

https://www.sennheiser-sites.com/responsive-manuals/XSW_IEM/EN/index.html

You have the following options to connect the antenna:

1 Connecting the antenna to the rear

- ▷ Connect the rod antenna to the **ANTENNA** socket on the rear side of the XSW IEM SR. In this case, cover the antenna holes with the covers.

Here, the original HTML instructions include an animated illustration which is not supported by the PDF format.

Open the HTML instructions in the Sennheiser Documentation App or on the Sennheiser website to display the animation:

https://www.sennheiser-sites.com/responsive-manuals/XSW_IEM/EN/index.html

For more information on mounting antennas on the rear of the device, see [Connecting rod antennas](#).

2 Connecting the antenna to the blanking plate

- ▷ Attach the antenna front mount kit and mount the rod antenna on the blanking plate.



Here, the original HTML instructions include an animated illustration which is not supported by the PDF format.

Open the HTML instructions in the Sennheiser Documentation App or on the Sennheiser website to display the animation:

https://www.sennheiser-sites.com/responsive-manuals/XSW_IEM/EN/index.html

- ▷ Slide the transmitter with the mounted blanking plate into the 19" rack.
- ▷ Secure the mounting bracket and the blanking plate to the 19" rack.
- ▷ Align the mounted antennas in a V-shape.

Mounting two receivers side by side in a rack

To mount two transmitters side by side:

- ▷ Place both transmitters upside down and side by side on an even surface.
- ▷ Secure the jointing plate to the transmitters using the six recessed head screws (M3x6).

Here, the original HTML instructions include an animated illustration which is not supported by the PDF format.

Open the HTML instructions in the Sennheiser Documentation App or on the Sennheiser website to display the animation:

https://www.sennheiser-sites.com/responsive-manuals/XSW_IEM/EN/index.html

- ▷ Secure the mounting bracket to the 19" rack.



Starting up the XSW IEM EK

Inserting and removing the batteries/rechargeable batteries

You can use the receiver with batteries (AA, 1.5 V).

- ▷ Press the two catches and open the battery compartment cover.
- ▷ Insert the batteries or the rechargeable battery as shown below. Please observe correct polarity when inserting the batteries.
- ▷ Close the battery compartment. The cover locks into place with an audible click.



For more information about the batteries' charging status, see Displays on the XSW IEM EK display panel.



Connecting earphones to the XSW IEM EK

CAUTION!

Danger due to high volume levels!

Subjecting your ears to sudden, loud volumes can permanently damage your hearing.

- ▷ Turn down the volume of the receiver before inserting the earphones.

To connect the earphones to the receiver:

- ▷ Insert the cable's 3.5 mm jack plug into the PHONES socket on the receiver.

Animation: "Connecting earphones"

Here, the original HTML instructions include an animated illustration which is not supported by the PDF format.

Open the HTML instructions in the Sennheiser Documentation App or on the Sennheiser website to display the animation:

https://www.sennheiser-sites.com/responsive-manuals/XSW_IEM/EN/index.html



Attaching the receiver to your clothing

You can use the belt clip to attach the receiver to your waistband or on a guitar strap. The belt clip is secured so that it cannot slide out of its fixing points accidentally.



Replacing the belt clip

To replace the belt clip, you will need the following materials:

- XSW IEM EK belt clip | art. no. 592582
- Slotted screwdriver with a maximum width of 1.0 mm
- Standard tweezers



Removing the belt clip

To remove the belt clip:

1. Place the receiver on a soft cloth with the front of the housing facing down.
2. Insert a slotted screwdriver with a maximum width of 1.0 mm into the gap between the first plastic fastener and the housing.

3. Carefully lever out the plastic fastener.

Work the hook on the bottom of the plastic fastener free so that you can remove the plastic fastener with tweezers.

If you cannot remove the plastic fastener easily, try also levering out the second hook on the faster toward the inside.

4. Repeat this procedure for the second plastic fastener.

CAUTION!

Risk of injury if the clip pops out.

The clip is under mechanical tension and can cause injuries if it pops out uncontrollably.

- ▷ During disassembly, keep one side of the clip firmly pressed against the housing.

Here, the original HTML instructions include an animated illustration which is not supported by the PDF format.

Open the HTML instructions in the Sennheiser Documentation App or on the Sennheiser website to display the animation:

https://www.sennheiser-sites.com/responsive-manuals/XSW_IEM/EN/index.html

5. During disassembly, press one side of the clip firmly against the housing while pulling the other end of the clip out toward the center of the housing and over the plastic protrusion.
6. Pull the second end of the clip out of the housing and remove the clip.



7. Discard the old plastic fasteners and clip.

Here, the original HTML instructions include an animated illustration which is not supported by the PDF format.

Open the HTML instructions in the Sennheiser Documentation App or on the Sennheiser website to display the animation:

https://www.sennheiser-sites.com/responsive-manuals/XSW_IEM/EN/index.html

Installing the belt clip

To install the belt clip:

1. Take the new belt clip and insert the left end of the clip into the left opening in the housing to the left of the plastic protrusion.

CAUTION!

Risk of injury if the clip pops out.

The clip is under mechanical tension and can cause injuries if it pops out uncontrollably.

- ▷ During disassembly, keep one side of the clip firmly pressed against the housing.

-
2. Press the left end of the clip against the housing while using your other hand to insert the other end of the clip into the right opening in the housing to the right of the plastic protrusion.
 3. Use tweezers to insert the new plastic fasteners into the holes in the housing with the hooks pointing downward.
 4. Press the plastic fasteners in with your finger. The plastic fasteners will snap into place.



Using the devices

You can find information about installing and connecting XSW IEM series devices in the following sections.



Using the XSW IEM SR



Using the XSW IEM EK



Using the XSW IEM SR

Controls on the XSW IEM SR transmitter

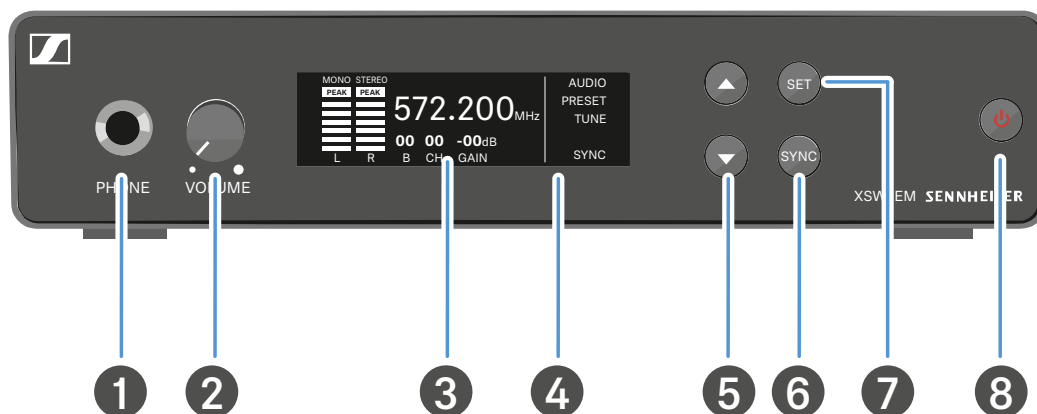

- 1** Headphone socket
 - See Using the headphone output
- 2** Volume control for the headphone socket
 - See Using the headphone output
- 3** Display panel
 - See Displays on the XSW IEM SR transmitter
- 4** Infrared interface
 - See Synchronizing devices
- 5** **UP** and **DOWN** buttons for navigating the menu
 - See Buttons for navigating the XSW IEM SR menu
- 6** **SYNC** button
 - See Synchronizing devices
- 7** **SET** button
 - See Buttons for navigating the XSW IEM SR menu
- 8** **STANDBY** button
 - See Switching the XSW IEM SR on and off



Switching the XSW IEM SR on and off

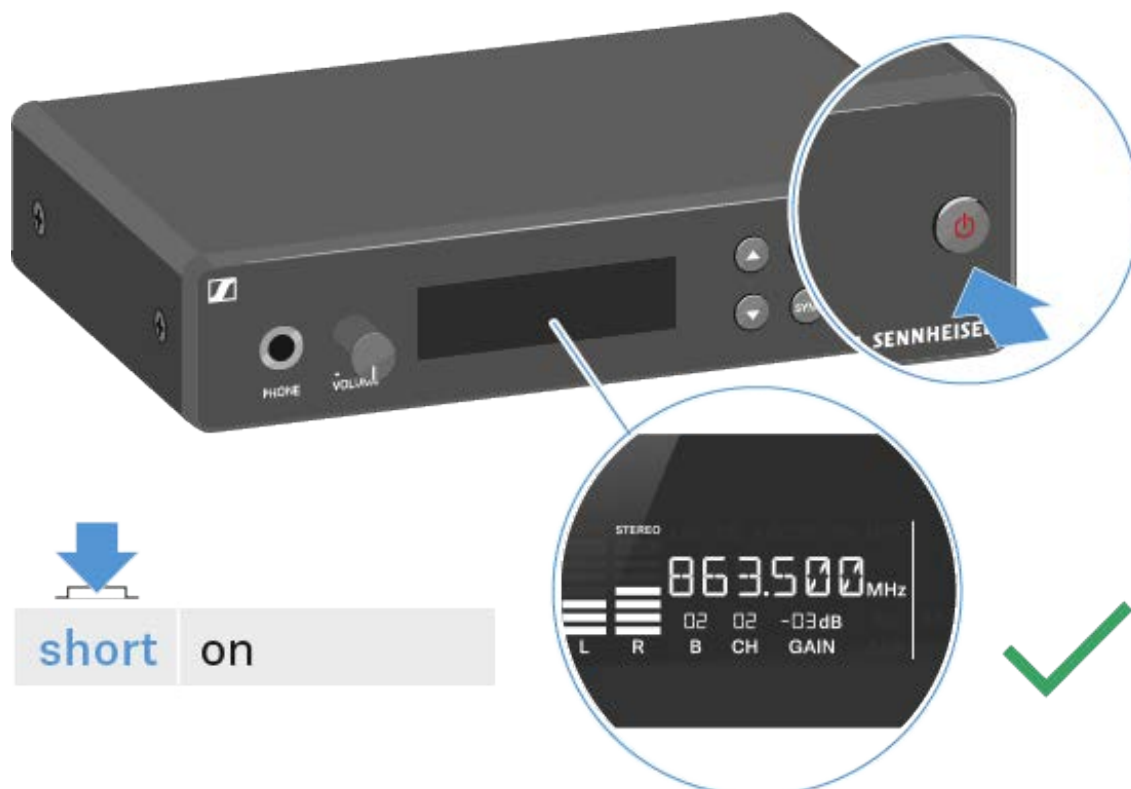

To switch on the transmitter:

- ▷ Short-press the **STANDBY** button.
The transmitter switches on and the standard display appears.

To switch the transmitter to standby mode:

- ▷ Press and hold the **STANDBY** button until **OFF** appears on the display panel.
The display panel switches off.

To switch the transmitter completely off:

- ▷ Disconnect the transmitter from the power supply system by unplugging the power supply unit from the wall socket.



Using the headphone output

You can use the headphone output on the front of the XSW IEM SR (6.3 mm jack) to listen to the audio signal.

CAUTION!

Danger due to high volume levels!

Volume levels that are too high may damage your hearing.

- ▷ Turn down the volume of the headphone output before you put on the headphones.

-
- ▷ Connect the headphones to the headphone socket.
 - ▷ You can control the volume by turning the volume knob next to the headphone socket.

Animation: “Connecting headphones”

Here, the original HTML instructions include an animated illustration which is not supported by the PDF format.

Open the HTML instructions in the Sennheiser Documentation App or on the Sennheiser website to display the animation:

https://www.sennheiser-sites.com/responsive-manuals/XSW_IEM/EN/index.html



Displays on the XSW IEM SR transmitter

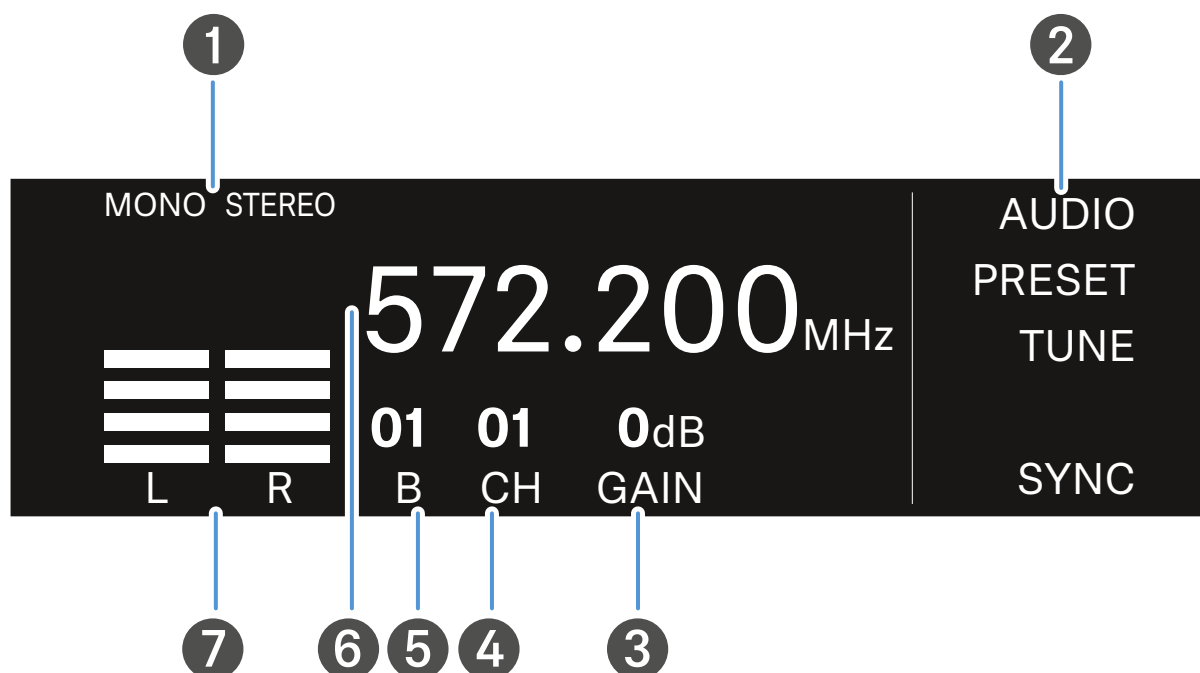

1 Mono/stereo settings

- See Configuring the audio transmission mode (mono/stereo)

2 Menu settings

3 Audio sensitivity (**GAIN**)

- See Setting the input sensitivity (GAIN)

4 Frequency bank (**CH**)

- See Selecting the frequency channel on the transmitter

5 Frequency bank (**B**)

- See Selecting the frequency bank on the transmitter

6 Current receiving frequency

- See Setting the frequency on the transmitter

7 AF audio level (audio frequency)

- Modulation of the audio channels



Buttons for navigating the XSW IEM SR menu

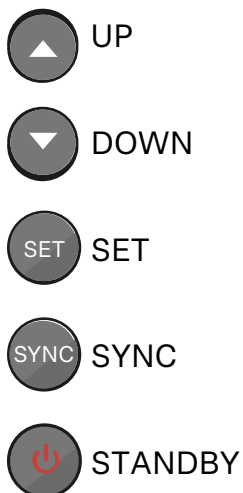

To open the menu:

- ▷ Press the **UP** or **DOWN** button to navigate through the menu.
- ▷ Press the **SET** button to open the menu.
The setting for the selected menu flashes.
- ▷ Press the **UP** or **DOWN** button to change the set values.
- ▷ Press the **SET** button to save the changes you made to the settings.

To exit the menu:

- ▷ Press the **STANDBY** button to exit the menu.



Setting options in the menu

AUDIO

Configuring the audio transmission mode (mono/stereo)

Setting the input sensitivity (GAIN)

PRESET

Selecting the frequency bank on the transmitter

Selecting the frequency channel on the transmitter

TUNE

Setting the frequency on the transmitter

Configuring the audio transmission mode (mono/stereo)

Under audio transmission mode, you can adjust the assignments of the audio inputs on the transmitter (mono/stereo).

Depending on how you configure the transmitter, the signals are converted to either mixed mono signals or mixed stereo signals. On the receiver, the user can control the distribution of incoming signals according to their preferences (see Panorama setting).

Setting range:

- MONO
- STEREO



To set the audio transmission mode to stereo/mono:

- ▷ Press the **UP** or **DOWN** button to access the **AUDIO** menu.
- ▷ Press the **SET** button to open the Stereo/Mono menu.
The setting for the selected menu flashes.
- ▷ Press the **UP** or **DOWN** button to change the set values.
- ▷ Press the SET button twice to save the settings you made.

To exit the menu:

- ▷ Press the **STANDBY** button to exit the menu.



Possible settings:

MONO

Only the transmitter's left audio input is transmitted. The receiver receives the signal as a mixed mono signal in both the left and right channels and reproduces it the same for both ears.

The **FOCUS** setting has no function in the mono configuration.

Example:

There is a solo artist on the stage. The artist sets the audio transmission mode to "Mono" and uses the left audio input on the transmitter. The mono signal is delivered to both ears at the receiver.

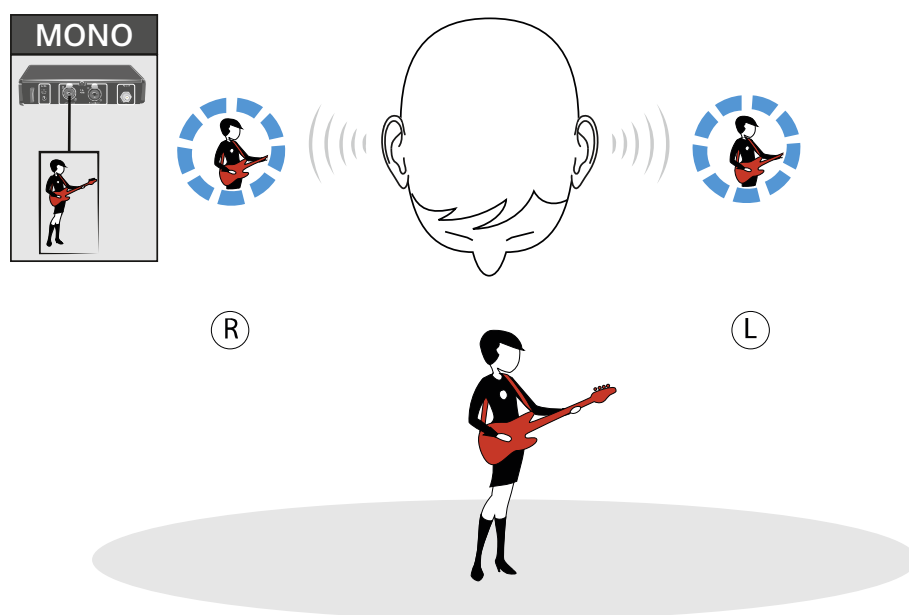

STEREO

The transmitter's left and right audio inputs are transmitted. Depending on the signal type (direct mono signal from artists or mixed stereo signals from the mixing console), the two audio channels are added and delivered to the listener as mixed mono signals (direct signals from artists) or mixed stereo signals (mixed signals from the mixing console).



You can use the Focus (Setting the FOCUS) and Panorama (see Panorama setting) functions to control the volume distribution on individual channels.

Example:

There are two artists on stage. You set the audio transmission mode to “Stereo” and assign the audio inputs as follows:

- Artist A uses the left audio input
- Artist B uses the right audio input

At the receiver, the mixed audio signals from both artists arrive at both ears and can then be individually controlled using the Focus and Panorama functions.

With the **FOCUS ON** setting, the two audio channels are added and arrive at the listener’s left and right ears as mixed mono signals. You can then adjust the mixing of the individual mono signals under Panorama (PAN).

With the **FOCUS OFF** setting, the two audio channels are added and arrive at the listener as mixed stereo signals. You can then adjust the balance of the mixed stereo signals under Panorama (PAN).

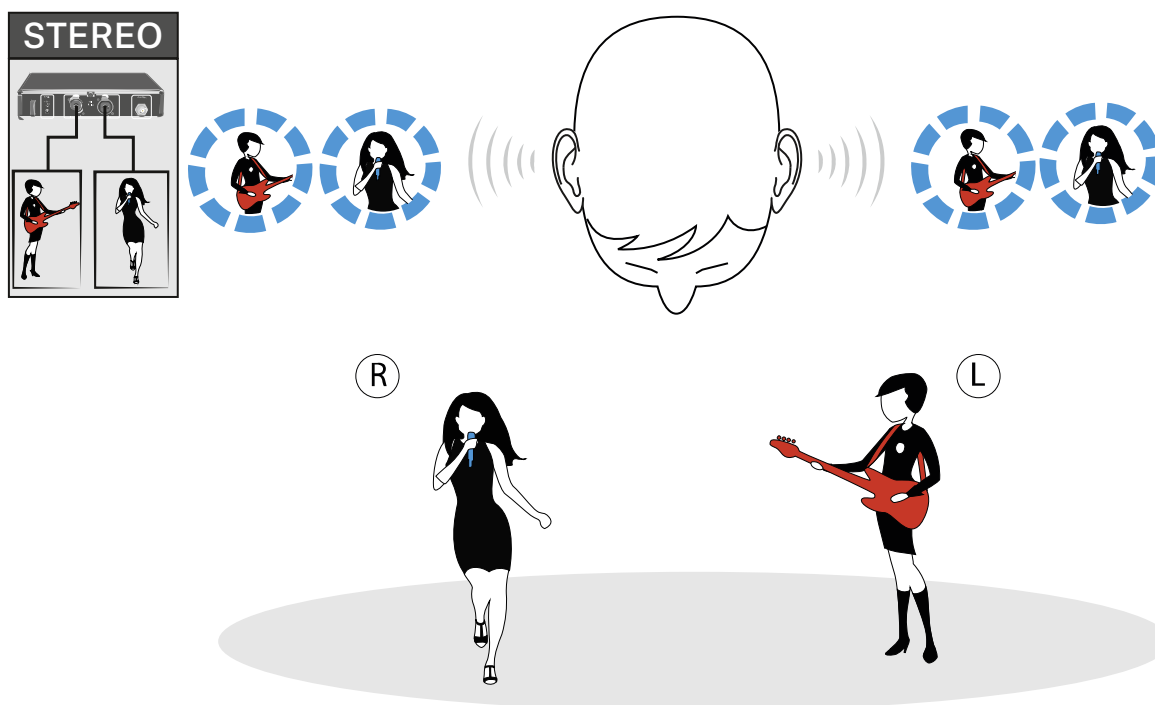



Setting the input sensitivity (GAIN)

In this menu item, you can set the input sensitivity.

Setting range:

- 0 dB to 21 dB in 3 dB steps

Set the input sensitivity (**GAIN**) on the transmitter so that the level shown on the display does not reach the maximum deflection (**PEAK**).



-21 dB ... 0 dB

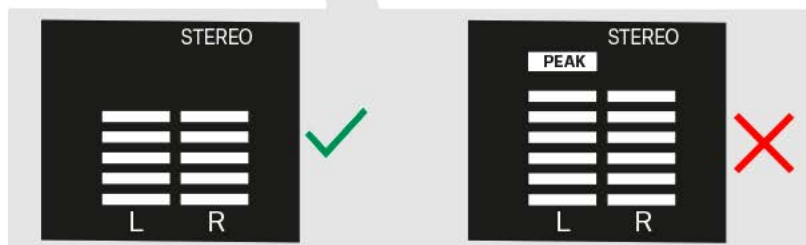

To adjust the input sensitivity:

- ▷ Press the **UP** or **DOWN** button to access the **AUDIO** menu.
- ▷ Press the **SET** button twice to open the **GAIN** menu.
The setting for the selected menu flashes.
- ▷ Press the **UP** or **DOWN** button to change the set values.
- ▷ Press the **SET** button twice to save the settings you made.

To exit the menu:

- ▷ Press the **STANDBY** button to exit the menu.



Selecting the frequency bank on the transmitter

In this menu item, you can select the frequency bank.

Please note the country-specific frequency ranges of public and private TV stations. Depending on where the transmitter is used, you are likely to find free frequencies within the following channel banks:

- Europe: channel banks 5 – 8
- America: channel banks 1 – 4

Before using the device, check whether there are interfering frequencies in your area (Finding an interference-free frequency (frequency test)) and then carry out a soundcheck (Performing a soundcheck).



To select the frequency bank:

- ▷ Press the **UP** or **DOWN** button to access the **SET** menu.
- ▷ Press the **SET** button to open the frequency bank menu (**B**). The setting for the selected menu flashes.
- ▷ Press the **UP** or **DOWN** button to change the set values.
- ▷ Press the **SET** button twice to save the settings you made.

To exit the menu:

- ▷ Press the **STANDBY** button to exit the menu.



Selecting the frequency channel on the transmitter

In this menu item, you can select the transmission channel.

Before using the device, check whether there are interfering frequencies in your area (Finding an interference-free frequency (frequency test)) and then carry out a soundcheck (Performing a soundcheck).



To select the transmission channel:

- ▷ Press the **UP** or **DOWN** button to access the **SET** menu.
- ▷ Press the **SET** button to open the channel menu (**CH**).
The setting for the selected menu flashes.
- ▷ Press the **UP** or **DOWN** button to change the set values.
- ▷ Press the **SET** button twice to save the settings you made.

To exit the menu:

- ▷ Press **STANDBY** to exit the menu.



Setting the frequency on the transmitter

Under the frequency menu item, you can manually set the transmission frequency.

Before using the device, check whether there are interfering frequencies in your area (Finding an interference-free frequency (frequency test)) and then carry out a soundcheck (Performing a soundcheck).

You can set the frequencies in 25 kHz steps.



To adjust the transmission frequency:

- ▷ Press the **UP** or **DOWN** button to access the **TUNE** menu.
- ▷ Press the **SET** button to open the frequency menu.
The current frequency flashes. The display for the frequency bank shows the value **U** and the display for the channel shows the value **00**.
- ▷ Press the **UP** or **DOWN** button to adjust the frequency in 25 kHz steps.
- ▷ Press the **SET** button twice to save the settings.

To exit the menu:

- ▷ Press the **STANDBY** button to exit the menu.



Using the XSW IEM EK

Controls on the XSW IEM EK receiver

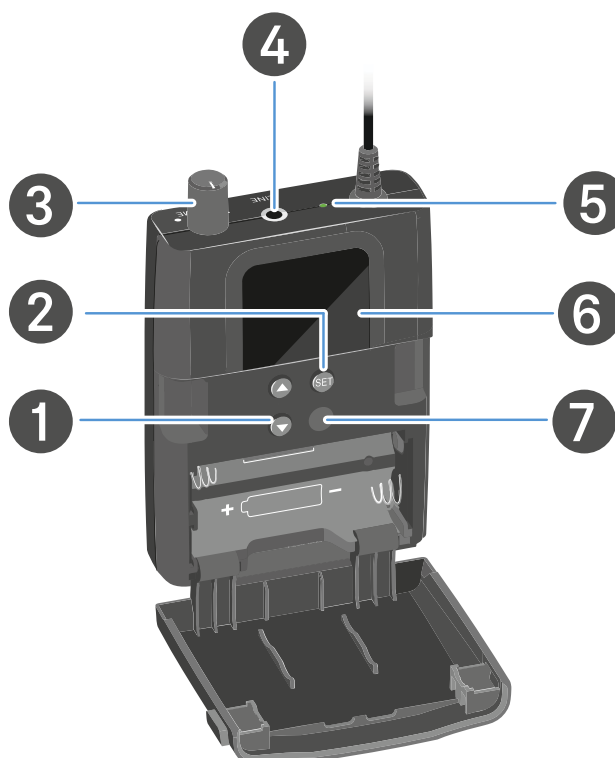

1 UP/DOWN buttons

- See Buttons for navigating through the menu

2 SET button

- Buttons for navigating through the menu

3 Volume control with on/off switch

- Switch the receiver on/off
See Switching the XSW IEM EK on and off

4 PHONES 3.5 mm jack socket

- For connecting earphones
See Connecting earphones to the XSW IEM EK

5 Operation and battery indicator

- See Switching the XSW IEM EK on and off
- See LED indicators on the XSW IEM EK

6 Display panel

7 Infrared interface

- See Synchronizing devices



Switching the XSW IEM EK on and off

CAUTION!

Danger due to high volume levels!

Subjecting your ears to sudden, loud volumes can permanently damage your hearing.

- ▷ Turn down the volume of the receiver before inserting the earphones.
-

To switch the receiver on:

- ▷ Turn the volume control clockwise until it clicks.
The LED on the receiver lights up red and the display panel shows the status **ON**. The default display with the frequency settings appears.



**To switch the receiver off:**

- ▷ Turn the volume control counterclockwise until it clicks. The red LED will go out. The receiver shows the status **OFF** on the display panel and switches off.









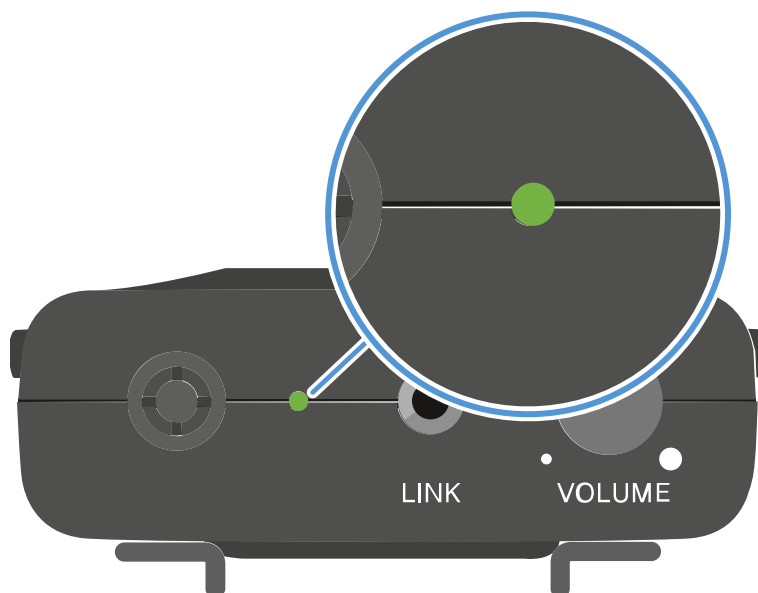

LED indicators on the XSW IEM EK

The LED indicators on the receiver show the current operating status, battery status and wireless reception status. The following statuses are possible:



-  Red [flashing steadily]: critical battery status
-  Red [constant light]: no wireless reception
-  Green [constant light]: wireless reception OK
-  Yellow [pulsing]: audio level
-  Yellow [constant light]: audio level too high
-  Red & green [flashing in alternation]: synchronizing



Displays on the XSW IEM EK display panel

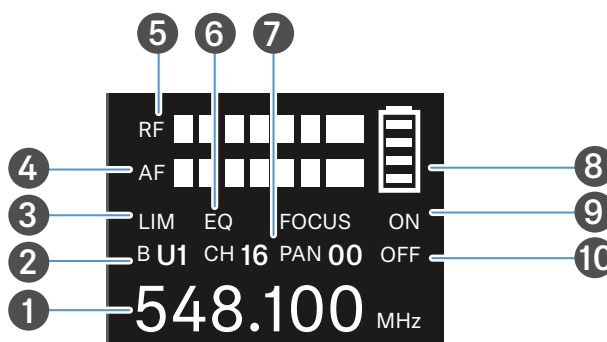

1 Frequency

- Current receiving frequency
- See Setting the frequency on the transmitter

2 Frequency bank (B)

- See Finding an interference-free frequency (frequency test)

3 Limiter (LIM)

- See Setting the frequency on the receiver

4 AF audio level (audio frequency)

- Displays the audio level of the received transmitter
- When the display shows full deflection, the audio input level is excessively high.
- See Setting the input sensitivity (GAIN)

5 RF signal level (radio frequency)

- RF signal level display

6 Equalizer (EQ)

- See Setting the high boost / equalizer

7 Frequency channel (CH)

- See Setting the frequency channel on the receiver

8 Battery status

- See “Inserting and removing the batteries/rechargeable batteries”
- Displays on the XSW IEM EK display panel

9 FOCUS audio channel:

- See Setting the FOCUS

10 Panorama (PAN)

- See Panorama setting



Battery indicators on the XSW IEM EK

You can see the current charging status of the batteries on the receiver's display panel.

Charging status of the batteries:

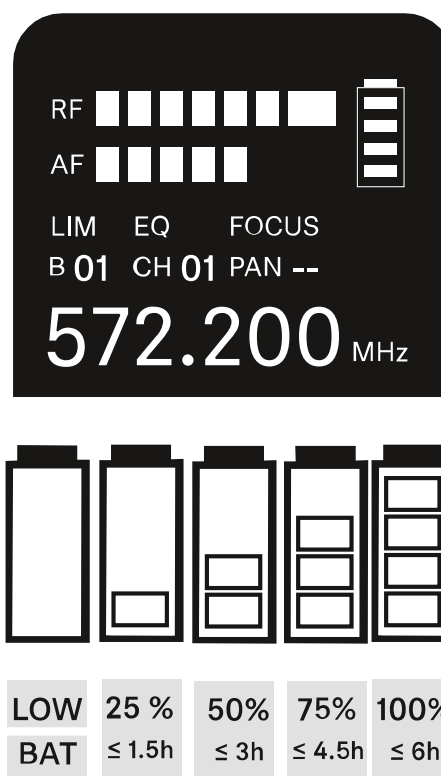

Charging status is critical (LOW BATT)

When the battery charge reaches a critical level, the battery icon flashes on the display panel and a red LED indicator flashes on the receiver.



Buttons for navigating through the menu

The following buttons are located on the XSW IEM EK receiver:



UP



DOWN



SET

- You can use the **UP** and **DOWN** buttons to adjust the set values.
- Press the **SET** button to open each menu item in succession.

All changes are temporarily saved until you have cycled through all menu items.

If you do not take any actions for 15 seconds, the device exits the SET menu and the changes are discarded.

You can do the following actions on the XSW IEM EK receiver:

To open a menu item

- ▷ Press the **SET** button

To change a value in a menu item

- ▷ Press the **UP** or **DOWN** button

To save settings and open the next menu item:

- ▷ Press the **SET** button

Tip: Press and hold the **SET** button for two seconds to quickly save your selected configuration. This applies the parameter changes and exits the menu.



Finding an interference-free frequency (frequency test)

You can perform a frequency test to check whether there are interfering frequencies in your area, without the help of another person.

Caution!

Danger due to high volume levels!

Subjecting your ears to sudden, loud volumes can permanently damage your hearing.

- ▷ Perform the frequency test without earphones or headphones.

To perform a frequency test:

- ▷ Switch the transmitter completely off (see Switching the XSW IEM SR on and off).
- ▷ Disconnect the earphones from the receiver and switch on the receiver (see Switching the XSW IEM EK on and off).
- ▷ Move the receiver around the area where it will be used.
- ▷ Observe the deflection of the **RF** signal level and the **AF** audio signal on the receiver's display panel.

When the receiver shows a deflection in the RF signal level:



The selected frequency has interference. This means that this frequency or a nearby frequency is already in use in your area.

- ▷ Select another frequency.
- ▷ Perform the frequency test again.



The receiver shows no deflection in the RF signal level:

There is no interference at the selected frequency. This frequency is interference free.

- ▷ Make sure that no AF audio level is displayed.
- ▷ Synchronize the selected frequency with the transmitter and perform a soundcheck (Performing a soundcheck).

The receiver shows a deflection in the AF audio level (audio frequency):



The receiver is receiving audio signals from a transmitter that uses the same frequency.

- ▷ Select another frequency.
- ▷ Perform the frequency test again.

The receiver does not show a deflection in the AF audio level (audio frequency):

The receiver is not receiving any audio signals. This frequency is not used by another transmitter.

- ▷ Make sure that no **RF signal level** is displayed.
- ▷ Synchronize the selected frequency with the transmitter and perform a soundcheck (Performing a soundcheck).



Setting the frequency bank on the receiver

You can set the frequency bank under the frequency bank menu item.

Please note the country-specific frequency ranges of public and private TV stations. Depending on where the transmitter is used, you are likely to find free frequencies within the following channel banks:

- Europe: channel banks 5 – 8
- America: channel banks 1 – 4

Before using the device, check whether there are interfering frequencies in your area (Finding an interference-free frequency (frequency test)) and then carry out a soundcheck (Performing a soundcheck).

Frequency tables for all available frequency ranges can be found on the download page of the Sennheiser website at www.sennheiser.com/download.



To set the frequency bank:

- ▷ Press the **SET** button repeatedly until the **B** display flashes.
- ▷ Press the **UP** or **DOWN** button to change the set values.
- ▷ Press the **SET** button
 - briefly to temporarily save the settings and move to the next menu item
 - for two seconds to immediately save the changes and exit the menu



Setting the frequency channel on the receiver

You can set the channel under the frequency channel menu item.

Before using the device, check whether there are interfering frequencies in your area (Finding an interference-free frequency (frequency test)) and then carry out a soundcheck (Performing a soundcheck).

Frequency tables for all available frequency ranges can be found on the download page of the Sennheiser website at www.sennheiser.com/download.



To set the frequency channel:

- ▷ Press the **SET** button repeatedly until the **CH** display flashes.
- ▷ Press the **UP** or **DOWN** button to change the set values.
- ▷ Press the **SET** button
 - briefly to temporarily save the settings and move to the next menu item
 - for two seconds to immediately save the changes and exit the menu



Setting the frequency on the receiver

You can set the receiving frequency manually under the frequency menu item.

Before using the device, check whether there are interfering frequencies in your area (Finding an interference-free frequency (frequency test)) and then carry out a soundcheck (Performing a soundcheck).

You can set the frequencies in 25 kHz steps.



To set the frequency:

- ▷ Press the **SET** button repeatedly until the frequency display flashes.
- ▷ Press the **UP** or **DOWN** button to adjust the frequency in 25 kHz steps.
- ▷ Press the **SET** button
 - briefly to temporarily save the settings and move to the next menu item
 - for two seconds to immediately save the changes and exit the menu



Performing a soundcheck

A soundcheck lets you test whether the transmission quality is sufficient over the entire area where you want to use the receiver, without the help of another person.

CAUTION!

Danger due to high volume levels!

Subjecting your ears to sudden, loud volumes can permanently damage your hearing.

- ▷ Turn down the volume of the receiver before inserting the earphones.

To perform a soundcheck:

- ▷ Switch on the transmitter and the receiver (see Switching the XSW IEM SR on and off | Switching the XSW IEM SR on and off).
- ▷ Set the same frequency on the transmitter and receiver (Establishing a radio link).
- ▷ Move the receiver around the area where it will be used. The receiver shows the following parameters:

RF signal level (radio frequency)



- RF signal level display
- The RF signal level must be noticeably deflected (at least 3 bars)

If no RF signal level is displayed:

- ▷ Switch on the transmitter (see Switching the XSW IEM SR on and off)
- ▷ Make sure that the same frequency is set on the transmitter and receiver (Establishing a radio link | Synchronizing devices).



- ▷ Check that the antennas and the antenna cables are correctly connected to the transmitter
- ▷ Move the transmitter to a better location
- ▷ If necessary, use an antenna booster

AF audio level (audio frequency)



- Displays the audio level of the received transmitter
- When the display shows full deflection, the audio input level is too high (see “Setting the input sensitivity (GAIN)”)
- A noticeable audio level must be displayed

If no audio level is displayed:

- ▷ Switch on the transmitter (see Switching the XSW IEM SR on and off)
- ▷ Make sure that the same frequency is set on the transmitter and receiver (Establishing a radio link, Synchronizing devices).
- ▷ Check that the antennas and the antenna cables are correctly connected to the transmitter
- ▷ Move the transmitter to a better location
- ▷ If necessary, use an antenna booster



Setting the limiter (LIM)

Under the limiter menu item, you can adjust the volume of the **PHONES** headphones output. When set to **ON**, the volume is reduced by 10 dB.

Setting range:

- ON (-10 dB)
- OFF



CAUTION!

Risk of hearing damage!

Subjecting your ears to excessive volumes over an extended period of time can permanently damage your hearing.

- ▷ Switch on the limiter before putting the earphones on. The limiter limits the volume of the headphone output **PHONES** and thus protects your hearing.
- ▷ Do not continuously expose yourself to high volume levels.

To switch the limiter on or off:

- ▷ Press the **SET** button repeatedly until the **LIM** display flashes.
- ▷ Press the **UP** or **DOWN** button to change the set values.
- ▷ Press the **SET** button
 - briefly to temporarily save the settings and move to the next menu item
 - for two seconds to immediately save the changes and exit the menu



Setting the high boost / equalizer

Under the equalizer menu item, you can adjust the treble boost of the output signal.

Setting range:

- 10 dB at 13 kHz

Values:

- ON
- OFF



To switch the equalizer on or off:

- ▷ Press the **SET** button repeatedly until the **EQ** display flashes.
- ▷ Press the **UP** or **DOWN** button to change the set values.
- ▷ Press the **SET** button
 - briefly to temporarily save the settings and move to the next menu item
 - for two seconds to immediately save the changes and exit the menu



Setting the FOCUS

In stereo mode, the **FOCUS** function controls the signal received from the transmitter at the receiver.

The **FOCUS** setting has no function in the mono configuration.

The signals at the receiver are reproduced either as mixed mono signals (**FOCUS ON**) or as mixed stereo signals (**FOCUS OFF**).

Setting range:

- ON
- OFF



To switch FOCUS on or off:

- ▷ Press the **SET** button repeatedly until the **FOCUS** display flashes.
- ▷ Press the **UP** or **DOWN** button to change the set values.
- ▷ Press the **SET** button
 - briefly to temporarily save the settings and move to the next menu item
 - for two seconds to immediately save the changes and exit the menu



Possible settings:

FOCUS ON

With the **FOCUS ON** setting, the two audio channels are added and arrive at the listener's left and right ears as mixed mono signals. The **PAN** function lets you adjust the mixing of the incoming mono signals.

Example:

There are two artists on stage. They are using the STEREO audio transmission mode. Both are using the focus function on the receiver (**FOCUS ON**). The audio signals from both artists are received by both receivers.

- Artist A (guitar) does not change the panorama value (**PAN --**) on her receiver. With this setting, artist A hears both artists in both ears.

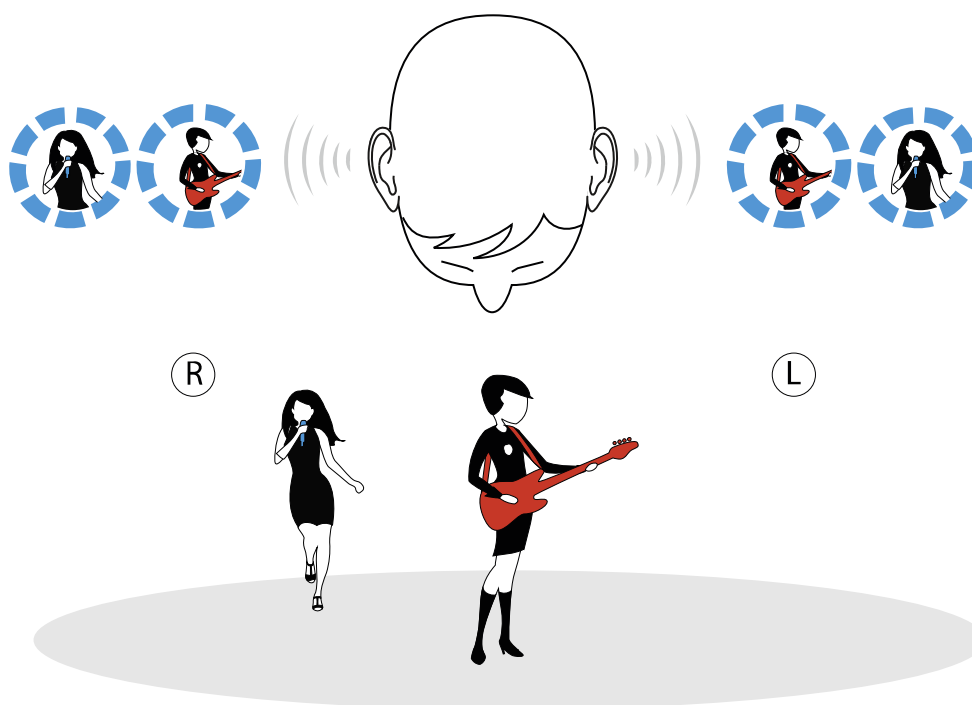



- Artist B (vocals) changes the panorama value on her receiver and shifts the mixed mono signal to the right channel (PAN R9). With this setting, artist B hears only herself in both ears.

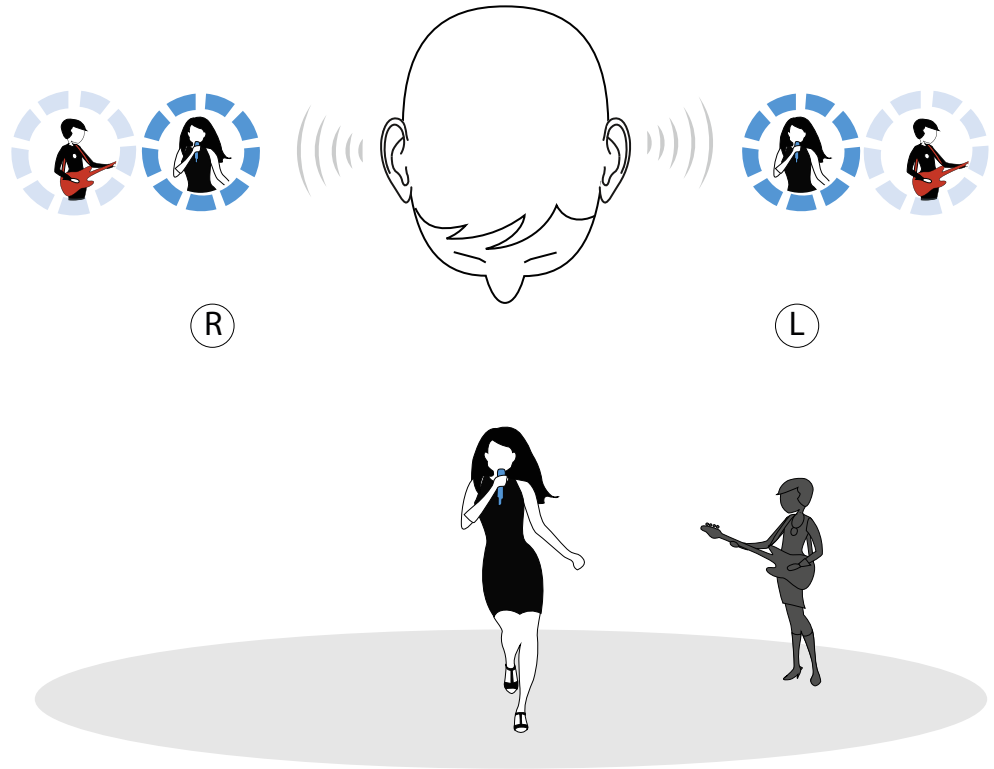



FOCUS OFF

With the **FOCUS OFF** setting, the two audio channels arrive at the listener as mixed stereo signals.

You can use the panorama function (**PAN**) to adjust the relative mixing of the stereo signals (comparable to controlling the volume of the right and left channels of the headphones).

Example:

There are multiple artists on stage. They are using the STEREO audio transmission mode on the transmitter. The mixed stereo signals from the mixing console are connected to both audio inputs of the transmitter. The mixed stereo signals from all artists arrive at all receivers.

- Artist A (guitar) does not change the panorama value (**PAN --**). With this setting, Artist A hears the mixed stereo signals from all artists in both ears.

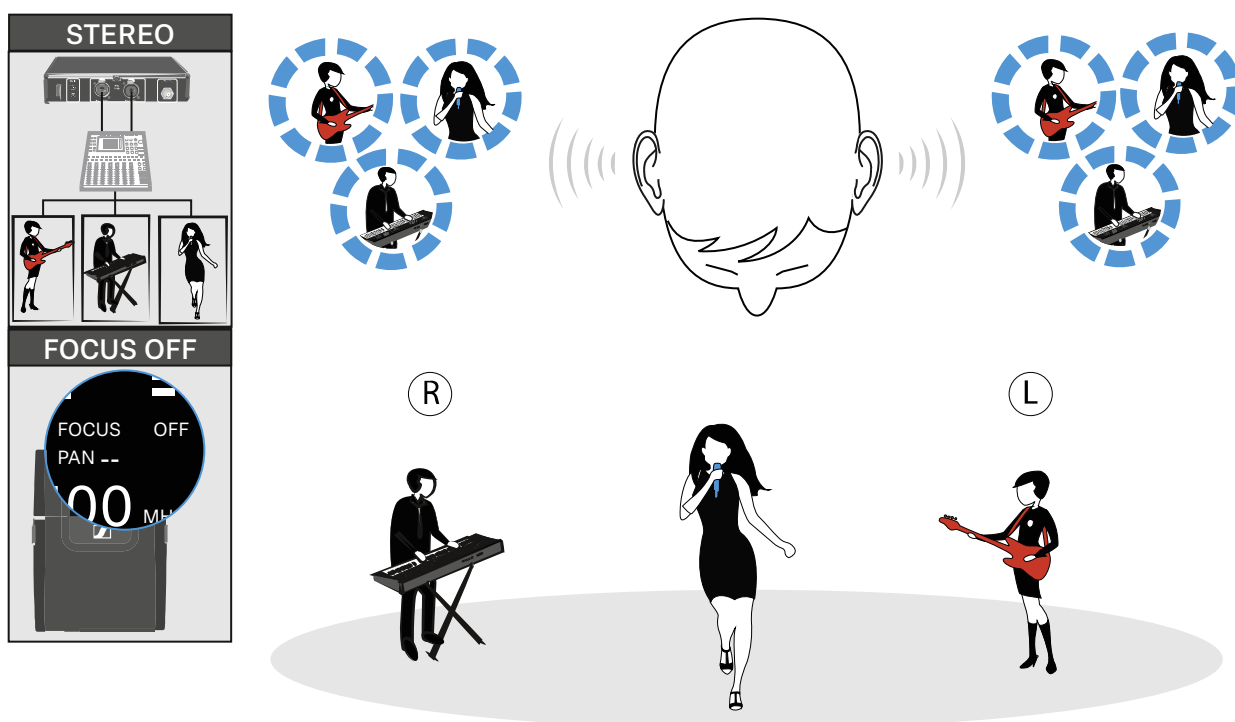



- Artist B (vocals) changes the panorama value to R9 and thus shifts the volume to the right (**PAN R9**). With this setting, artist B hears all artists but only in her right ear.

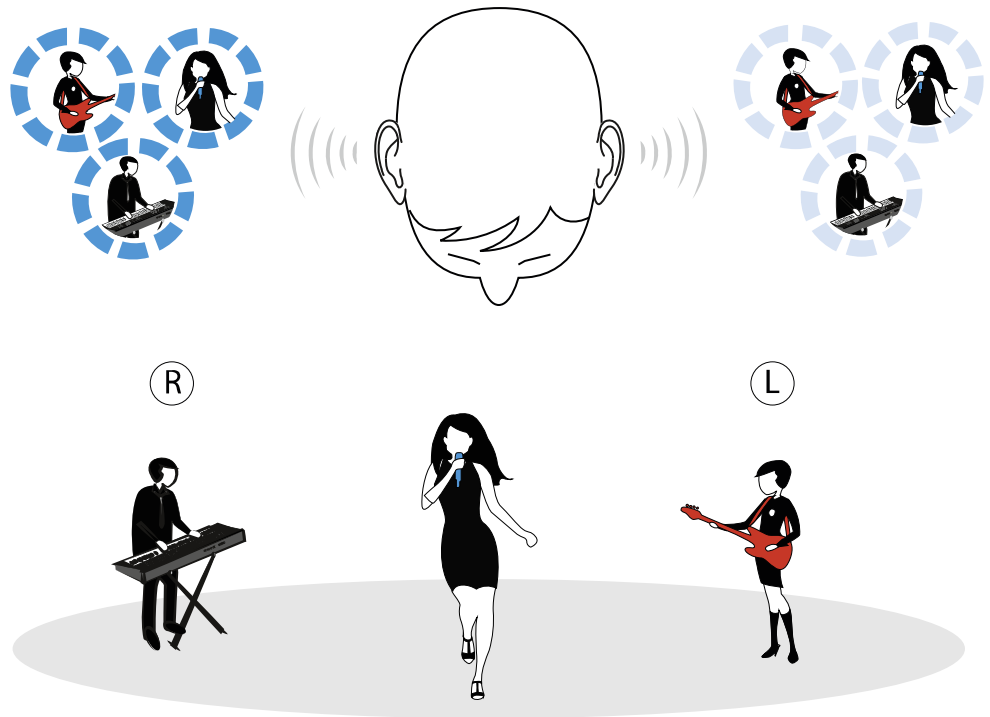
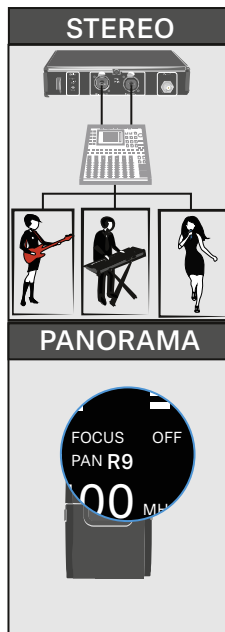



Panorama setting

In the **PAN** menu item, you can control the volume distribution of an audio signal over two channels.

In stereo mode, the **FOCUS** function controls the signal received from the transmitter at the receiver. In the mono configuration **FOCUS** has no function.

Setting range:

- --
- L1 to L9
- R1 to R9



To adjust the balance/focus:

- ▷ Press the **SET** button repeatedly until the **PAN** display flashes.
- ▷ Press the **UP** or **DOWN** button to change the set values.
- ▷ Press the **SET** button
 - briefly to temporarily save the settings and move to the next menu item
 - for two seconds to immediately save the changes and exit the menu



Panorama function in stereo mode:

FOCUS ON

With the **FOCUS ON** setting, the two audio channels are added and arrive at the listener's left and right ears as mixed mono signals.

The **PAN** function lets you adjust the mixing of the incoming mono signals.

Example:

There are two artists on stage. They are using the STEREO audio transmission mode. The audio signals from both artists are received by both receivers.

- Artist B (vocals) changes the panorama value on her receiver and shifts the mixed mono signal to the right channel (PAN R9). With this setting, artist B hears only herself in both ears.

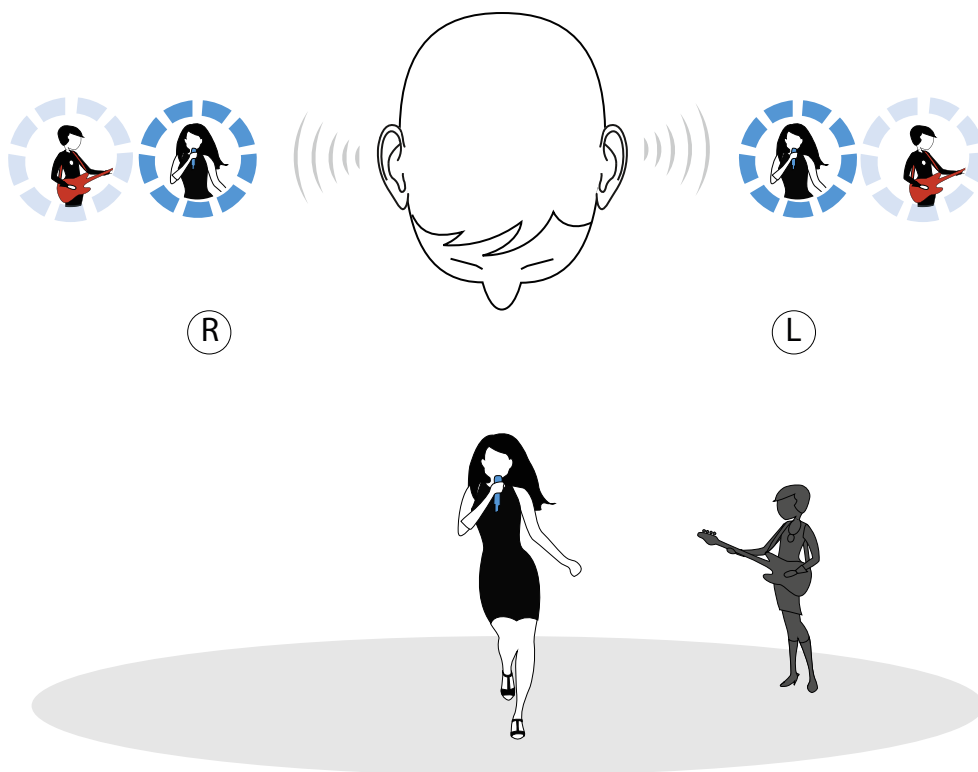



FOCUS OFF

With the **FOCUS OFF** setting, the two audio channels arrive at the listener as mixed stereo signals.

You can use the **PAN** function to adjust the relative mixing of the stereo signals (comparable to controlling the volume of the right and left channels of the headphones).

Example:

There are multiple artists on stage. They are using the STEREO audio transmission mode on the transmitter. The mixed stereo signals from the mixing console are connected to both audio inputs of the transmitter. The mixed stereo signals from all artists arrive at all receivers.

Artist B (vocals) changes the panorama value to R9 and thus shifts the volume to the right (PAN R9). With this setting, artist B hears all artists but only in her right ear.

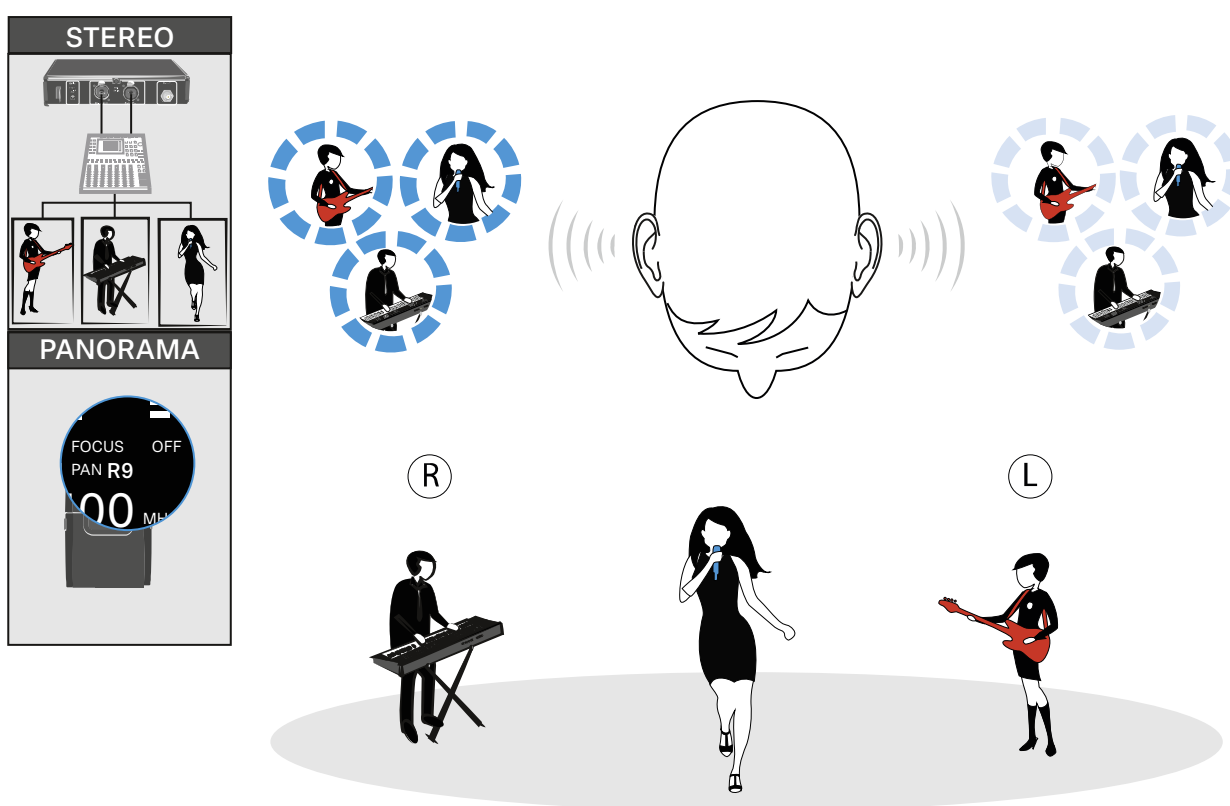



Establishing a radio link

To establish a radio link between the transmitter and receiver, the same frequency must be set in both devices. Before using the device, check whether there are interfering frequencies in your area (Finding an interference-free frequency (frequency test)) and then carry out a soundcheck (Performing a soundcheck).

You have the following options to establish a radio link:

- 1** Set the frequency on the transmitter manually (see Setting the frequency on the transmitter) and synchronize it with the receiver (see Synchronizing devices).

OR

- 2** Select a frequency already preset on the transmitter and synchronize it with the receiver (see Synchronizing devices). In this case, you can select the frequency bank (see Selecting the frequency bank on the transmitter) and the transmission channel (see Selecting the frequency channel on the transmitter).

OR

- 3** Set the same frequency on both devices (see Setting the frequency on the transmitter and Setting the frequency on the receiver). Synchronization is not necessary in this case.

Setting notes

Please note the following when synchronizing a transmitter with a receiver:

- ▷ Only use transmitters and receivers from the same frequency range (see the type plate on the transmitter and receiver).
- ▷ Make sure that your chosen frequencies are listed in the frequency table for the particular frequency range (see “Frequency tables”).
- ▷ Ensure that the desired frequencies are permitted in your country and apply for an operating license if necessary.



Synchronizing devices

You can synchronize the XSW IEM transmitter and receiver using the infrared interfaces. The channel selected on the transmitter is transmitted to the receiver.

To synchronize the devices, ensure that no menu is selected on the transmitter (no values flashing). Before using the device, check whether there are interfering frequencies in your area (Finding an interference-free frequency (frequency test)).



To synchronize the devices:

- ▷ Switch the transmitter and the receiver on.
- ▷ Press the **SYNC** button on the transmitter.
The **SYNC** display flashes on the transmitter display panel for 10 seconds.
- ▷ Hold the infrared interface of the receiver in front of the infrared interface of the transmitter.
The parameters are transferred to the receiver.
Once transmission is complete, the transmitter returns to the default display.

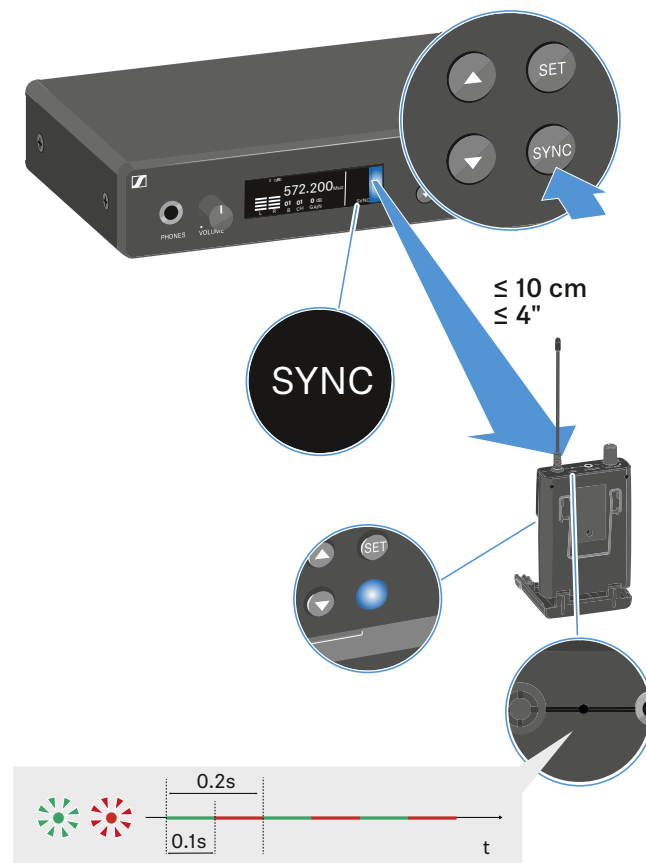

To cancel synchronization:

- ▷ Press either the **SET** button, the **UP** button or the **DOWN** button on the transmitter.

The transmitter reverts to the default display.



Cleaning and maintaining the devices

Note the following information when cleaning and maintaining XSW IEM series products.

CAUTION!

Liquids can damage the products' electronics.

Liquids entering the product housing can cause a short-circuit and damage the electronics.

- ▷ Keep all liquids away from the products.
 - ▷ Do not use any solvents or cleansing agents.
-
- ▷ Disconnect the products from the power supply system and remove rechargeable batteries and batteries before you begin cleaning.
 - ▷ Clean all products only with a soft, dry cloth.



FREQUENTLY ASKED QUESTIONS

This section contains answers to frequently asked questions and further information about the following topics:



Radio and frequencies



Audio



Usability



Accessories





Radio and frequencies

Why won't my transmitter synchronize with my receiver?

- To synchronize the devices, ensure that no menu is selected on the transmitter (no values flashing).
- The receiver's battery compartment must be open.
- The distance between the transmitter and receiver should be approx. 10 cm.

What is the transmission range of the transmitter/receiver?

- Up to 50 m in an ideal environment (without obstacles)

What is the best way to wear the bodypack receiver?

- Do not kink, bend or cover the antenna
- Avoid skin contact with the antenna
- If possible, attach it to your clothing with the belt clip

The transmitter and receiver are synchronized, but there is no connection.

- Correctly mount the antennas on the transmitter (Connecting rod antennas)
- Resynchronize the transmitter and receiver (Synchronizing devices)

The receiver does not show a level during the soundcheck

- ▷ Switch on the transmitter (see Switching the XSW IEM SR on and off)
- ▷ Make sure that the same frequency is set on the transmitter and receiver (Establishing a radio link | Synchronizing devices).
- ▷ Check that the antennas and the antenna cables are correctly connected to the transmitter
- ▷ Move the transmitter to a better location
- ▷ If necessary, use an antenna booster



**The display on the receiver shows radio levels even though the paired transmitter is not switched on**

- The selected frequency has interference. This means that this frequency or a nearby frequency is already in use in your area.
 - ▷ Select another frequency.
 - ▷ Perform a frequency test (Performing a soundcheck).
 - ▷ Synchronize the devices again (Synchronizing devices)

Which frequency ranges are available?

- See the chapter The frequency bank system.





Audio

What other in-ear earphones can I use with my receiver?

- See <https://www.sennheiser.com/in-ear-monitoring>

What other devices can I use with my XSW IEM?

- Multiple receivers (XSW IEM EK) can be paired to one transmitter (XSW IEM SR) and used simultaneously.
- The stereo transmitter is also designed for interference-free operation with the wireless microphones of the XS Wireless series.

How many receivers can I use with a single XSW IEM SR?

- The transmitter delivers the data to an indefinite set of receivers within a fixed geometric area. Therefore, any number of receivers can receive the transmitted audio data.

What exactly does the “GAIN” setting do?

- “GAIN” adjusts the level of the audio signal coming from the transmitter (Setting the input sensitivity (GAIN))

How can I adjust sensitivity on the receiver?

- You cannot make any settings on the receiver. You can adjust the level of the signal coming from the transmitter under the **GAIN** menu item (see Setting the input sensitivity (GAIN)) on the transmitter.

What audio inputs are there on the transmitter?

- 6.3 mm jack (see Connectors on the rear of the device)





Usability

Why won't my transmitter synchronize with my receiver?

- To synchronize the devices, ensure that no menu is selected on the transmitter (no values flashing).
- The receiver's battery compartment must be open.
- The distance between the transmitter and receiver should be approx. 10 cm.
- For more information, see chapter Performing a sound-check

Can I see the receiver's battery status on the transmitter?

- No, the receiver's battery status is only displayed on the receiver (see Battery indicators on the XSW IEM EK).

How do I know if my receiver is switched on?

- The **LED** on the receiver lights up (LED indicators on the XSW IEM EK).
- The display panel shows the current settings (Switching the XSW IEM EK on and off).
- You can reactivate the display panel by pressing any button on the receiver.

The LED on the receiver is steady yellow or flashing yellow. What does that mean?

- The receiver is receiving audio signals. The display indicates different audio signal levels (see LED indicators on the XSW IEM EK).

The LED on the receiver is steady red. What does that mean?

- The receiver has no wireless reception (see LED indicators on the XSW IEM EK).

The LED on the receiver is flashing red. What does that mean?





- The receiver's battery status is critical (see LED indicators on the XSW IEM EK).
- The batteries or rechargeable batteries must be replaced (Inserting and removing the batteries/rechargeable batteries)

Can I also operate an XSW IEM with desktop applications such as WSM or Control Cockpit?

- No, that is not possible.

Is there an app for the XSW IEM series?

- No, there is no app for this series.
- There is, however, a documentation app. This app lets you download all available instruction manuals and use them offline (details at <https://www.sennheiser.com/documentation-app>).

Can I switch on my transmitter without it transmitting immediately?

- No. To find an interference-free frequency, we recommend leaving the transmitter switched off and carrying out a frequency test with the receiver (see Performing a sound-check).

Can I operate the XS Wireless 1 and 2 series together with the XSW IEM series?

- Yes, the stereo transmitter is designed for interference-free operation with the wireless microphones of the XS Wireless series.

What exactly does the "GAIN" setting do?

- "GAIN" adjusts the level of the audio signal coming from the transmitter (Setting the input sensitivity (GAIN))
- Set the input sensitivity on the transmitter so that the level shown on the display does not reach the maximum deflection (PEAK) (Setting the input sensitivity (GAIN)).





What is the best way to wear the bodypack transmitter?

- Do not kink, bend or cover the antenna
- Avoid skin contact with the antenna
- If possible, attach it to your clothing with the belt clip





Accessories

What other in-ear earphones can I use with my receiver?

- See <https://www.sennheiser.com/in-ear-monitoring>

Which batteries can I use for my transmitter?

- 2 x AA 1.5 V
- See Inserting and removing the batteries/rechargeable batteries

Can I use accessories that I already have from other series?

- You can use passive devices without a power supply (e.g. AD 1800 or A 1031-U antennas).
- XSW IEM EK belt clip
- XSW IEM EK BATTERY COVER
- BNC antenna
- NT 12-5CW power supply unit
- XSW rack mount kit
- XSW antenna cable for rack front mounting
- Antenna combiner

Which antennas can I use with my transmitter?

- In principle, you can use all antennas with a BNC connector that cover the frequency ranges of the XSW IEM series (see The frequency bank system)
- Recommended Antennas

What does the XSW rack mount kit include?

- Mounting brackets for mounting a single transmitter in a rack
- Blanking plate for mounting and connecting the rod antenna with an antenna front mount kit
- Jointing plate for connecting two transmitters
- Necessary screws and caps





Can I use the rack mount kit from my XS Wireless 1 or 2?

- Yes, the XS Wireless 1 and 2 rack mount kits (XSW Rack Mount Kit) are compatible with the XSW IEM series and vice versa.

Can I replace the belt clip?

- Yes, the belt clip can be replaced (see Replacing the belt clip).





SPECIFICATIONS

In the sections below, you can find information about the different variants of the products in the XSW IEM series as well as technical data for the individual products.



Variants



Frequency tables



Specifications



Pin assignment



Variants

The following sections list the variants of the various products along with the approved frequencies.



XSW IEM SR variants



XSW IEM EK variants



XSW IEM SR variants



XSW IEM SR-A		476 – 500 MHz		Art. no. 509151
XSW IEM SR-B		572 – 596 MHz		Art. no. 509152
XSW IEM SR-C		662 – 686 MHz		Art. no. 509153
XSW IEM SR-E		823.2 – 831.8 MHz		Art. no. 509154
XSW IEM SR-K		925.2 – 937.3 MHz		Art. no. 509155



XSW IEM EK variants



- XSW IEM EK-A | 476 – 500 MHz | Art. no. 509156
- XSW IEM EK-B | 572 – 596 MHz | Art. no. 509157
- XSW IEM EK-C | 662 – 686 MHz | Art. no. 509158
- XSW IEM EK-E | 823.2 – 831.8 MHz | Art. no. 509159
- XSW IEM EK-K | 925.2 – 937.3 MHz | Art. no. 509160



Specifications

You can find the cross-system and product-specific technical data in the sections below.



Specifications of XSW IEM SR



Specifications of XSW IEM EK



Specifications of XSW IEM SR



RF characteristics

Modulation type

FM broadband stereo

Reception frequency ranges:

A: 476 – 500 MHz

B: 572 – 596 MHz

C: 662 – 686 MHz

E: 823.2 – 831.8 MHz

K: 925.2 – 937.3 MHz

Switching bandwidth

up to 24 MHz

Nominal/peak deviation

± 15 kHz / ± 24 kHz

Antenna output

BNC socket, 50 Ω

RF output power

10 to 30 mW (not adjustable, depends on the frequency variant and local regulations in the respective country)

AF characteristics

AF frequency response

45 to 15.000 Hz

**AF input**

BAL AF In L (I) + MONO/

BAL AF In R (II) 2x XLR-3/6.3 mm jack combo socket (1/4"),
electronically balanced**Total harmonic distortion (at 1 kHz and nominal deviation)**

< 0.9%

Signal-to-noise ratio at nominal load and peak deviation

≥ 88 dB

Overall device**Temperature range**

0 °C to +40 °C (32 °F to 104 °F)

Power supply

DC +12 V

Current consumption

Max. 400 mA (depending on the volume)

Dimensions

Approx. 200 x 128 x 42 mm

Weight approx. 700 g



Specifications of XSW IEM EK



RF characteristics

Modulation type

Wideband FM

Reception frequency ranges

A: 476 – 500 MHz

B: 572 – 596 MHz

C: 662 – 686 MHz

E: 823.2 – 831.8 MHz

K: 925.2 – 937.3 MHz

Switching bandwidth

up to 24 MHz

Nominal/peak deviation

± 15 kHz / ± 24 kHz

Squelch

10 μ V



AF characteristics

Signal-to-noise ratio (1 mV, peak deviation)

≥ 88 dB

Audio THD

≤ 1%

Output power

2 x 1.25 V_{eff} at 16 Ω

High boost

+10 dB at 13 kHz

Limiter

-10 dB

Frequency response

45 Hz to 15 kHz

Cross talk (50 Hz – 10 kHz)

> 45 dB

Overall device

Temperature range

0 °C to +40 °C (32 °F to 104 °F)

Power supply

2 AA batteries, 1.5 V or NiMH



Nominal voltage

Battery: 3 V

Rechargeable battery: 2.4 V

Operating time

approx. 6 hours (depending on volume)

Dimensions approx.

95 × 70 × 26 mm (1 3/4" × 3 7/8" × 7 3/16")

Weight (with batteries)

Approx. 110 g



Frequency tables

Frequency tables for all available frequency ranges can be found on the download page of the Sennheiser website at www.sennheiser.com/download.

Enter XSW IEM in the search bar to show the frequency tables.

There may be special conditions and restrictions for using frequencies in your country. Before starting up the product, find the information for your country at the following address: www.sennheiser.com/sifa



Pin assignment

3.5 mm stereo jack plug

- Plug for headphone and earphone cables, e.g. IE 4
- Connect to: XSW IEM EK

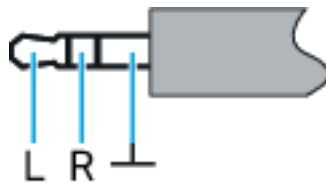

6.3 mm stereo jack plug, balanced (audio in/loop out)

Connect to:

- XSW IEM SR Audio In
- XSW IEM SR Loop Out

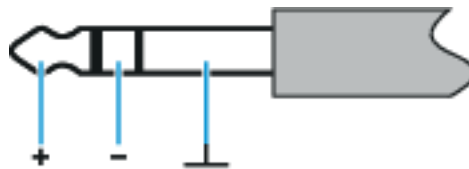

6.3 mm stereo jack plug for headphone connector

Connect to XSW IEM SR headphone input

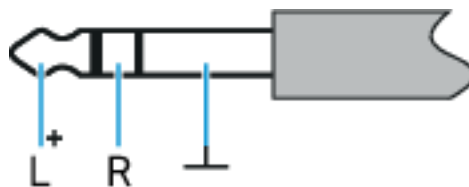



XLR-3 plug, balanced

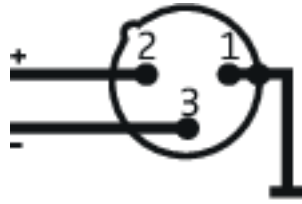

Hollow jack plug for power supply

